



# BLOOD, LAND AND POWER

THE RISE AND FALL OF THE  
SPANISH NOBILITY AND LINEAGES IN  
THE EARLY MODERN PERIOD

MANUEL PEREZ-GARCIA

IBERIAN AND LATIN AMERICAN STUDIES

*Blood, Land and Power*

### **Series Editors**

Professor David George (Swansea University)

Professor Paul Garner (University of Leeds)

### **Editorial Board**

Samuel Amago (University of Virginia)

Roger Bartra (Universidad Autónoma de México)

Paul Castro (University of Glasgow)

Richard Cleminson (University of Leeds)

Catherine Davies (University of London)

Luisa-Elena Delgado (University of Illinois)

Maria Delgado (Central School of Speech and Drama, London)

Will Fowler (University of St Andrews)

David Gies (University of Virginia)

Gareth Walters (Swansea University)

Duncan Wheeler (University of Leeds)

### **Other titles in the series**

Fantastic Short Stories by Women Authors from  
Spain and Latin America: A Critical Anthology

*Patricia Gracia and Teresa López-Pellisa*

Carmen Martín Gaité: Poetics, Visual Elements and Space

*Ester Bautista Botello*

The Spanish Anarchists of Northern Australia:  
Revolution in the Sugar Cane Fields

*Robert Mason*

Paulo Emilio Salles Gomes: On Brazil and Global Cinema

*Maite Conde and Stephanie Dennison*

The Darkening Nation: Race, Neoliberalism  
and Crisis in Argentina

*Ignacio Aguiló*

Catalan Culture: Experimentation, creative imagination and the  
relationship with Spain

*Lloyd Hughes Davies, J. B. Hall and D. Gareth Walters*

Madness and Irrationality in Spanish and Latin American  
Literature and Culture

*Lloyd Hughes Davies*

IBERIAN AND LATIN AMERICAN STUDIES

# *Blood, Land and Power*

*The Rise and Fall of the Spanish Nobility  
and Lineages in the Early Modern Period*

MANUEL PEREZ-GARCIA



UNIVERSITY OF WALES PRESS  
2021

This work is licensed under the Creative Commons Attribution-NonCommercial-NoDerivatives 4.0 International Licence. To view a copy of this licence, visit <http://creativecommons.org/licenses/by-nc-nd/4.0/> or send a letter to Creative Commons, PO Box 1866, Mountain View, CA 94042, USA



[www.uwp.co.uk](http://www.uwp.co.uk)

*British Library CIP*

A catalogue record for this book is available from the British Library.

ISBN 978-1-78683-710-3

e-ISBN 978-1-78683-711-0

The right of Manuel Perez-Garcia to be identified as author of this work has been asserted in accordance with sections 77 and 79 of the Copyright, Designs and Patents Act 1988.

*Blood, Land and Power* is available as an open access publication

DOI 10.16922/bloodlandpower

This research has been sponsored and financially supported from the GECEM (*Global Encounters between China and Europe: Trade Networks, Consumption and Cultural Exchanges in Macau and Marseille, 1680-1840*) Project hosted by the University Pablo de Olavide, UPO (Seville, Spain), [www.gecem.eu](http://www.gecem.eu). The GECEM Project is funded by the ERC (European Research Council)-Starting Grant, under the European Union's Horizon 2020 Research and Innovation Programme, ref. 679371. The Principal Investigator is Professor Manuel Perez-Garcia (Distinguished Researcher at UPO).



Cover image: Francisco Pradilla Ortiz, *The Capitulation of Granada* (1882), oil on canvas, coll. Senado de España, Madrid; by permission, Heritage Image Partnership Ltd / Alamy Stock Photo.

Typeset by Geethik Technologies

The publisher has no responsibility for the persistence or accuracy of URLs for any external or third-party internet websites referred to in this book, and does not guarantee that any content on such websites is, or will remain, accurate or appropriate.

To my father Manuel Pérez García who has set an outstanding example of perseverance, dedication, love, and passion to his work in the medical profession. His altruistic and generous service to the care of the community deserves full recognition, being an example to follow for the education and direction of the family. Without your support and your example of commitment and enthusiasm to your work, I would never have been able to write this book.

The family is the stronghold to keep the values, ethics and unity of our society.

This page is deliberately blank

# Contents

---

Series Editors' Foreword	ix
Acknowledgements	xi
List of Figures, Graphs and Tables	xv
Foreword by J. B. Owens	xxi
Introduction	1
1 Lineage, Glory and Honour in the Late Middle Ages: Conquest and Consolidation of Economic Power	7
2 Honour and Purity of Blood	40
3 Building a Social Network through Political, Social and Institutional ties	105
4 Family and Entailed Estate ( <i>Mayorazgo</i> ): First-Borns as Keepers of the Family's Economic Power	164
Conclusions	221
Bibliography	228
Notes	255
Appendix	298
Index	327



This page is deliberately blank

# Series Editors' Foreword

---

Over recent decades the traditional 'languages and literatures' model in Spanish departments in universities in the United Kingdom has been superseded by a contextual, interdisciplinary and 'area studies' approach to the study of the culture, history, society and politics of the Hispanic and Lusophone worlds – categories that extend far beyond the confines of the Iberian Peninsula, not only in Latin America but also to Spanish-speaking and Lusophone Africa.

In response to these dynamic trends in research priorities and curriculum development, this series is designed to present both disciplinary and interdisciplinary research within the general field of Iberian and Latin American Studies, particularly studies that explore all aspects of Cultural Production (inter alia literature, film, music, dance, sport) in Spanish, Portuguese, Basque, Catalan, Galician and indigenous languages of Latin America. The series also aims to publish research in the History and Politics of the Hispanic and Lusophone worlds, at the level of both the region and the nation-state, as well as on Cultural Studies that explore the shifting terrains of gender, sexual, racial and postcolonial identities in those same regions.

This page is deliberately blank

# Acknowledgements

---

This book is the result of the academic actions and activities of the GECEM (*Global Encounters between China and Europe: Trade Networks, Consumption and Cultural Exchanges in Macau and Marseille, 1680–1840*, [www.gecem.eu](http://www.gecem.eu)) Project. The workshops and academic forums in which I have participated since GECEM started in June 2016, in Tokyo, Beijing, Boston, Shanghai, Oxford, Paris, Vancouver, Seville, Mexico City, Guadalajara, San José (Costa Rica) and Murcia have served to obtain feedback from outstanding scholars and improve upon the ideas and early drafts of this book.

I wish to acknowledge the financial support of the European Research Council (ERC)-Starting Grant, under the European Union's Horizon 2020 Research and Innovation Programme, at the Pablo de Olavide University (UPO) in Seville (Spain), which acts as European host for GECEM. The academic collaboration with my colleague and friend Professor Lucio de Sousa (Tokyo University of Foreign Studies) has helped and encouraged me to undertake my career as a historian in China and in the 2011 founding of the *Global History Network in China* (GHN) in Beijing, [www.globalhistorynetwork.com](http://www.globalhistorynetwork.com).

We have jointly established a permanent academic forum of discussion and publications through GHN to promote knowledge and understanding of the still unknown East Asian world and culture, and the exchanges with Europe and the Western world. Expanding the GHN through organised academic meetings in China, Europe, and the Americas has helped us to invigorate the field of global history and early modern history of western and eastern regions. Obtaining my current European Research Council (ERC)-Starting Grant in the autumn of 2015 has made it possible to further this mission, which has crystallised in the publication of this book by the University of Wales Press.

I am grateful to academic institutions and partners of GECHEM and GHN such as Shanghai Jiao Tong University, Tokyo University of Foreign Studies, the Beijing Center for Chinese Studies at the University of International Business and Economics (Beijing, China), the Macau Ricci Institute at the University of Saint Joseph (Macau), the Faculty of Asian and Middle Eastern Studies at the University of Cambridge, the Centre for Global History at the University of Oxford, the Center of Global History and European Studies at Pittsburgh University, the Centre of Global History at the University of Warwick, the Universidad Nacional Autónoma de México (UNAM), the École des Hautes Études en Sciences Sociales (Paris, France), the European University Institute (Florence, Italy), the Universidad Autónoma de Madrid, and the Faculty of Economics and Business at the Universidad de Murcia.

I specially want to thank GECHEM Project team members Bartolomé Yun-Casalilla, Marisol Vidales Bernal, Omar Svriz, Manuel Díaz Ordoñez, Nadia Fernández de Pinedo Echeverría, María Jesús Milán Agudo, Rocío Moreno Cabanillas, Felix Muñoz, Jin Lei, Wang Li and Guimel Hernández. I am grateful to comments and suggestions made by Jack Owens, Jesus Cruz, Jean-Pierre Dedieu, Mafalda Soares da Cunha, Luis Jauregui, Richard von Glahn, Bartolomé Yun-Casalilla, Anne McCants, Shigeru Akita, Gakusho Nakajima, Mihoko Oka, Carlos Marichal, Dennis Flynn, Patrick O'Brien, Pat Manning, Joe P. McDermott, Leonard Blusse, François Gipouloux, Debin Ma, Leonor Diaz de Seabra and Antonio Ibarra. I would also like to thank the PAIDI group HUM-1000 *Historia de la Globalización: Violencia, Negociación e Interculturalidad* at Area de Historia Moderna (UPO), of which I am a member. The Principal Investigator of the PAIDI group is Igor Pérez Tostado, funded by *Junta de Andalucía* (Seville, Spain). Igor Pérez, Bethany Aram and Fernando Ramos deserve a special word of gratitude for their support and help. I also express my gratitude to the Project HAR2014-53797-P *Globalización Ibérica: redes entre Asia y Europa y los cambios en las pautas de consumo en Latinoamérica* whose Principal Investigator is Bartolomé Yun-Casalilla, funded by the *Ministerio de Economía y Competitividad* (MINECO). I am also a research member of this project.

Special mention should be made of Professor Manuel Barcia (Chair of Global History at the University of Leeds) for his support with this book. Also, a special word of thanks to Sarah Lewis, head

of commissioning at the University of Wales Press, for believing in this project. I am thankful for the assistance of Paula de la Cruz-Fernández and Elisabeth O’Kane Lipartito (from the translation and editing group *Edita.us*) in the proofreading, translating and reviewing of this manuscript.

My wife Marisol Vidales Bernal needs a very special word of thanks as she played a key role in developing my work and research in China. She has helped and encouraged me to undertake my career as a historian in China. Her generous support and love beyond limits have helped me to overcome great difficulties and to carry on with our life in the Far East. Without her, this book would not have been possible.

In addition, I would like to express my gratitude to the Delegation of the European Union to China and Euraxess China, which has been essential in expanding the scientific results and GECEM output to Chinese academic and non-academic audiences. The main goal is to transfer knowledge from China to Europe and vice versa, as well as spreading the history and culture of Europe within China. The constant and generous support of Philippe Vialatte (Minister Counsellor, Head of Science and Technology Section of the Delegation of the European Union to China) and Halldor Berg (Chief Representative of Euraxess China) to the GECEM Project and GHN is of great value when expanding our mission and fostering high-quality academic research among European and non-European researchers based in China.

*Shanghai (China), autumn 2019*

This page is deliberately blank

# Figures, Graphs and Tables

---

## Figures

Figure 1.1	Genealogy of the Riquelme lineage (1264–1598)	38
Figure 2.1	Genealogy of the Paz Family, fifteenth to eighteenth centuries	102, 298
Figure 3.1	Crossed marriages of siblings of different sex (endogamy)	108
Figure 3.2	Crossed marriages of siblings of same sex (endogamy)	108
Figure 3.3	Intergenerational endogamic marriages	113
Figure 3.4	Endogamic unions through marriage turn	115
Figure 3.5	Social network of Riquelme and Fontes families in the <i>concejo</i> (1700–1820)	142
Figure 3.6	Social network of Riquelme and Fontes families in ecclesiastical institutions (1700–1820)	143
Figure 3.7	Antonio Fontes Paz's (third marquis of Torre Pacheco) social network through the <i>Cofradías</i> of Santiago de la Espada and Nuestro Padre Jesús Nazareno (1700–1820)	155
Figure 3.8	Coalition between the Riquelme and Fontes lineages, seventeenth to nineteenth centuries	162, 300
Figure 4.1	Castilian inheritance system	165
Figure 4.2	Endogamy marriages between siblings	167
Figure 4.3	<i>Señorío</i> of Santo Ángel, fifteenth to seventeenth centuries	170, 302
Figure 4.4	Line of inheritance of the <i>señorío</i> of Campo Coy in the Riquelme lineage, sixteenth to seventeenth centuries	175
Figure 4.5	Line of inheritance of the <i>mayorazgo</i> that Don Cristóbal de Arroniz, third lord of Santo Ángel, and Doña Nofra Riquelme founded, sixteenth to seventeenth centuries	176



Figure 4.6	Line of inheritance of the <i>mayorazgo</i> that Don Diego Riquelme de Comontes, third lord of Coy, and Doña Beatriz Bustamante founded, sixteenth to seventeenth centuries	178
Figure 4.7	Line of transfer of Pedro Muñoz's <i>mayorazgo</i> , sixteenth to seventeenth centuries	180
Figure 4.8	Line of transfer of the <i>mayorazgo</i> that Juan de Robles and Catalina Musso Davila founded, sixteenth to seventeenth centuries	181
Figure 4.9	Line of transfer of the <i>mayorazgo</i> of Don Juan de Junco and Doña Francisca Ballester, seventeenth century	184, 303
Figure 4.10	Line of transfer of the <i>mayorazgo</i> of Doña Fabiana Salad y Anduga, seventeenth century	184
Figure 4.11	Line of transfer of the <i>mayorazgo</i> of Don Diego Riquelme de Avilés and Doña Constanza de Bernal, sixteenth to nineteenth centuries	188, 304
Figure 4.12	Line of transfer of the <i>mayorazgo</i> of Don Pedro Hurtado de Mendoza, sixteenth to nineteenth centuries	189, 305
Figure 4.13	Line of transfer of the <i>mayorazgo</i> that Don Onofre Fontes de Albornoz and Doña Isabel Pagán Riquelme founded, sixteenth to nineteenth centuries	190, 306
Figure 4.14	Line of transfer of the <i>mayorazgo</i> that Don Alonso de Paz founded, sixteenth to nineteenth centuries	193, 307
Figure 4.15	Line of transfer of the <i>mayorazgo</i> that Don Jaime de Rocamora founded, sixteenth to nineteenth centuries	194, 308
Figure 4.16	Line of transfer of the <i>mayorazgo</i> that Doña Ana de Moya founded	195, 309
Figure 4.17	Line of transfer of the <i>mayorazgo</i> of Don Juan Damián de la Peraleja, seventeenth to nineteenth centuries	196, 310
Figure 4.18	Riquelme-Fontes genealogy and links with the Peraleja family, sixteenth to nineteenth centuries	197, 311
Figure 4.19	Line of transfer of the <i>mayorazgo</i> that Don Bernardino Fontes de Albornoz Riquelme founded, seventeenth to nineteenth centuries	198, 312
Figure 4.20	Line of transfer of the <i>mayorazgo</i> that Don Macías Fontes Carrillo, first marquis of Torre Pacheco, founded, seventeenth to nineteenth centuries	200
Figure 4.21	Line of transfer of the <i>mayorazgo</i> that Don Alejandro Fontes founded	202

Figure 4.22	Line of transfer of the <i>mayorazgo</i> that Don Gaspar de Salafrañca and Doña Ana de Zúñiga founded	210, 313
Figure 4.23	Line of transfer of the <i>mayorazgo</i> that Don Cristóbal, Doña Nofra, Don Luis, don Diego Riquelme and Doña Isabel de Bustamante founded as shown in the decisions of the <i>Consejo de Castilla</i>	211, 314
Figure 4.24	Line of transfer of the <i>mayorazgo</i> that Don Cristóbal, Doña Nofra, Don Luis, Don Diego Riquelme and Doña Isabel de Bustamante owned in real and practical terms	212, 315
Figure 4.25	Genealogy of Riquelme family in coalition with Salafrañca family, sixteenth to nineteenth centuries	214, 316
Figure 4.26	Genealogy of Riquelme family in coalition with Almela, Junco, and Salad y Anduga y Tomas Families, sixteenth to seventeenth centuries	216, 320
Figure 4.27	Genealogy of Riquelme lineage, thirteenth to nineteenth centuries	218, 322

## Graphs

Graph 1.1	Social structure of the Riquelme lineage	12
Graph 1.2	Lands given to the Riquelme in the thirteenth-century land partitions	14
Graph 1.3	Riquelme family members as <i>regidores</i>	37
Graph 2.1	Inquisitorial processes of the Paz family of Frejenal background (1491–1550)	67
Graph 2.2	Declarations of the interrogation processes at Frejenal	74
Graph 2.3	Witnesses' social status	78
Graph 2.4	Witnesses' professions	78
Graph 2.5	Membership of military orders by Riquelme lineage and related families, sixteenth to eighteenth centuries	83
Graph 2.6	<i>Hábitos</i> in the hands of Riquelme lineage and related families, sixteenth to eighteenth centuries	83
Graph 2.7	<i>Regidurías</i> of the Riquelme-Fontes (1598–1833)	91
Graph 2.8	Riquelme members in nobility <i>cofradías</i> , sixteenth to eighteenth centuries	101

Graph 3.1	Social status of the members of the <i>Cofradías</i> of Santiago de la Espada and Nuestro Padre Jesús Nazareno, seventeenth to nineteenth centuries	161
Graph 4.1	Income (in <i>reales</i> ) of lands of two <i>mayorazgos</i> under Juana Riquelme from year one to year four	177

### Tables

Table 1.1	Social structure of the Riquelme lineage	11
Table 1.2	Lands owned by Pedro Gómez Dávalos seized after the 1391 rebellion	20
Table 1.3	Public office positions held by the Riquelme family, thirteenth to sixteenth centuries	34
Table 2.1	Positions of the Paz Family (1411–1600)	59
Table 2.2	Interrogation in the <i>villa</i> and court of Madrid	61
Table 2.3	Interrogation in the city of Murcia	62
Table 2.4	Genealogical antecedents of the Paz family	64
Table 2.5	Individuals ascribed to the Fontes-Paz lineage and qualified as <i>actos positivos</i>	69
Table 2.6	Interrogation in Frejenal de la Sierra	72
Table 2.7	Interrogation at the <i>villa</i> of Berlanga	77
Table 2.8	Military order <i>hábitos</i> of the Riquelme lineage and related families, sixteenth to eighteenth centuries	81
Table 2.9	Nobility titles presented during <i>limpieza de sangre</i> examinations of Francisco de Borja Fontes Riquelme and Antonio Fontes Abad	85
Table 2.10	Military positions in the <i>Consejos Reales</i> exercised by Riquelme and Fontes members, sixteenth to eighteenth centuries	86
Table 2.11	<i>Regidurías</i> of the Riquelme-Fontes, seventeenth and eighteenth centuries	89
Table 2.12	Riquelme-Fontes appointed as <i>alcaldes</i>	91
Table 2.13	Riquelme-Fontes in the <i>Cofradía</i> of Santiago de la Espada	95
Table 2.14	Riquelme-Fontes in the <i>Cofradía</i> of San Pedro Mártir de Verona	98
Table 2.15	Riquelme-Fontes with positions in the <i>Santo Oficio</i> , sixteenth to eighteenth centuries	98
Table 2.16	Caro Fontes members of the <i>Cofradía</i> Nuestra Señora de la Soledad de Valencia	101
Table 3.1	The zenith of the Riquelme lineage: Martín Riquelme's (' <i>el valeroso</i> ') marriage strategy	110
Table 3.2	Riquelme family civil and ecclesiastical powers	112

Table 3.3	<i>Prebendados</i> of the Riquelme lineage in the cathedral of Murcia	112
Table 3.4	Consanguineal marriages between Riquelme-Fontes	117
Table 3.5	Double marriages within the Riquelme lineage	121
Table 3.6	Marrying age	123
Table 3.7	The dowry and <i>arras</i> of the Riquelme-Fontes family, fifteenth to eighteenth centuries	129
Table 3.8	Riquelme-Fontes nuns	133
Table 3.9	Baptismal and marriage records, sixteenth to eighteenth centuries	137
Table 3.10	Life-cycle of Antonio Fontes Paz (third marquis of Torre Pacheco)	144
Table 3.11	Notarial records	145
Table 3.12	Frequency of individuals/relations with Antonio Fontes Paz	152
Table 3.13	Position of <i>regidor</i> : purity of blood examination of Antonio Fontes Paz	153
Table 3.14	Frequency of relations of Antonio Fontes Paz with individuals of the <i>Cofradías</i> of Santiago de la Espada and Nuestro Padre Jesús Nazareno (1700–1820)	156
Table 3.15	Frequency of relationships between Antonio Riquelme y Fontes and other individuals from the <i>Cofradías</i> of Santiago de la Espada and Nuestro Padre Jesús Nazareno (1794–1843)	159
Table 4.1	Properties in the <i>mayorazgo</i> that Don Cristóbal and Doña Nofra Riquelme created	171
Table 4.2	Lists (memorial) of the property linked to Luis Riquelme de Aviles	171
Table 4.3	Lands rented by Cristóbal Riquelme de Arroniz (sixth lord of Santo Ángel) that were under <i>mayorazgo</i>	174
Table 4.4	Income of lands under Don Cristóbal Riquelme and Arroniz, sixth lord of Santo Ángel	177
Table 4.5	Possessions in Pedro Muñoz's <i>mayorazgo</i>	181
Table 4.6	Succession order that Pedro Muñoz's <i>mayorazgo</i> clauses established	182
Table 4.7	Censuses	185
Table 4.8	Land properties	187
Table 4.9	Properties belonging to the <i>mayorazgo</i> that Don Onofre Fontes de Albornoiz and Doña Isabel Pagán Riquelme founded	189
Table 4.10	Properties of the <i>vínculo</i> that Don Alonso de Paz founded	191
Table 4.11	Properties of the <i>mayorazgo</i> founded by Don Jaime Rocamora	193

Table 4.12	Properties in the <i>mayorazgo</i> of Don Juan Damián de la Peraleja	196
Table 4.13	Properties in the <i>mayorazgo</i> of Don Macías Fontes Carrillo (first marquis of Torre Pacheco)	199
Table 4.14	Properties in the <i>mayorazgo</i> of Don Alejandro Fontes	201
Table 4.15	Additions to the <i>mayorazgo</i> of Don Alejandro Fontes	201
Table 4.16	Properties in the <i>mayorazgo</i> of Don Juan Marín Blázquez	202
Table 4.17	Properties in the <i>mayorazgo</i> of Doña Catalina de Avilés y Fajardo	204
Table 4.18	Properties in the <i>mayorazgo</i> of Don Gaspar de Salafranca and his spouse Doña Ana de Zúñiga	210
Table 4.19	Riquelme lineage branches competing for the Riquelme, Muñoz, Robles, Bustamante, Peñaranda and Salafranca <i>mayorazgos</i>	213
Table 4.20	Social network of the Riquelme created by founding <i>mayorazgos</i>	220

# Foreword

---

You are about to read an important book. Perhaps I can best defend this assertion by recounting a personal anecdote.

At the end of 1977, I arrived with my family in Murcia, a city on the Segura river in south-eastern Spain, which none of us had visited before. From the publications of Professor Juan Torres Fontes, one of Spain's most distinguished medieval historians and Murcia's municipal archivist, I knew that the collection of the volumes of the *Actas capitulares*, the minutes of the sessions of the city's civic council (*ayuntamiento*) survived with gaps from 1364–5. For the period after the fourteenth century, only two volumes are missing, one for the fifteenth century and one for the sixteenth. Important municipalities like Murcia typically administered a large territorial jurisdiction, and that of Murcia extended well beyond its irrigated orchards and fields. Its jurisdiction extended from the right bank of the Segura to the Mediterranean Sea and from the left bank well into the arid pasturelands for large flocks of goats and sheep. I had also read, on microfilm, a remarkable book published in 1621 by an important Golden Age writer and Murcian native, Francisco de Cascales (1563?–1642). As part of his *Discursos históricos* about Murcia, Cascales included brief chapters about many of the patrician families, highlighting their estates, marriages, office holding, service to Church and crown, and honours. I had begun to computerise this information, which provided the basis for the funding proposal I submitted to a joint Spanish–US committee to support my research in Murcia.

During almost twenty months, I read through the *Actas capitulares* and learned a great deal about the interests of the patrician councillors who held positions as *jurados* (parish representatives) and *regidores* (royally designated governors). My understanding of

the cultural and social environments of the Murcian region was also greatly enriched by recent publications of young, talented French and Spanish researchers. On this basis, in 1980 I published a book (in Spanish) showing the impact of a Murcian social revolution, 1519–22, in the midst of a larger Castilian rebellion against the kingdom's royal administration. The revolutionary leaders exiled all of Murcia's elite councillors and their relatives in order to establish a broader-based municipal government. In exile the patrician councillors established a pact for joint action. My book tells the story of this revolutionary period and, until its demise in the 1540s and 1550s, the development of a more cohesive oligarchic government once the revolution had been defeated.

Because I intended to publish a second book recounting the subsequent crisis decade of the 1560s and the emergence from potential disaster of a much more cohesive oligarchy, I read all of the *Actas capitulares* until the middle of the seventeenth century. On this basis, in 1981 I published (in Spanish) a guide to the civic council from about 1500 until 1650. In this work I explain the nature of Murcia's government, and I list all of the *jurados* and *regidores*. I felt that one could not generalise about the actions of a deliberative body without knowing something about the motivations of those who participated in its meetings.

Because this type of research possessed implications well beyond the local, I sought to establish a model for work on municipal councils: a researcher would tie a historical narrative to published information about the men who held council seats and their families. Moreover, I hoped that if other historians knew the identities of the patrician councillors during some important period, they would focus their work on other archival collections in order to enrich our understanding of these men and the interactions of elite men and women, which shaped not only Murcia's history but that of the expanding, planetary Hispanic monarchy as well.

Along with others, Manuel Perez-Garcia answered my call. The promulgation of the Spanish constitution of 1978 opened a period of regionalism in the country's political and cultural life, and the publication of local histories founded on municipal and regional archives emerged as something of a 'cottage industry'. However, Perez-Garcia's ambition extends well beyond this often limited genre. To achieve his goals, he exploits a variety of important types of archival holdings beyond the records of the civic council, which

I used. Moreover, he expands the chronological limits of the story to encompass over five centuries, and its geographical limits to encompass the kingdom of Murcia (roughly the modern provinces of Albacete and Murcia) and territories beyond its boundaries. From this broad perspective, he recognises that the key activities, which would show the dense connections among elite men and women, pointed to the founding, maintenance, and expansion of entailed estates (*mayorazgos*), the major family legal tool for avoiding the damaging fragmentation of a lineage's patrimony among multiple heirs. To carve his way through the dense jungle surrounding the entailed estate, particularly over a long period of time, Perez-Garcia selects an important lineage, the Riquelme, whose fortunes he could follow over a number of centuries. These two brilliant decisions – to focus on entailed estates (and inheritance conflicts) and on the social networks of the resilient Riquelme – enable him to make an outstanding contribution to our growing understanding of the Hispanic monarchy until the entire edifice of what some historians call the 'Old Regime' crumbled when liberal constitutionalism emerged as a revolutionary force, which changed for ever the political framework and themes of conflict and social cohesion for a new Spanish nation.

J. B. Owens PhD  
Emeritus Professor of History and  
Distinguished Researcher,  
Idaho State University, USA  
Boise, Idaho  
May 2020



This page is deliberately blank

*God, what a good vassal! If only he had a worthy lord.*

(Anon., *Cantar de Mio Cid*, verse 20.

Translation into English from  
P. Blackburn and G. Economou,

*Poem of the Cid:  
A Modern Translation with Notes*  
(Norman: University of  
Oklahoma Press, 1998), p. 9)

This page is deliberately blank

# Introduction

---

Western and eastern values of society underscore the family as a fundamental social structure and institution.<sup>1</sup> The family reveals the most significant sociocultural features of European communities in a given context, and these become central communication channels back to the family. This idea asserts James Casey's axiom that family and society are part of a single unit.<sup>2</sup>

The family is at the centre of this study and is also its organisational reference: through the structure of the family, I show how a complex and highly hierarchised society like the *ancien régime's* worked and evolved. Furthermore, the individual is the main protagonist of this social tapestry. The tracking of the life-cycle, namely by following main vital events such as birth, marriage and death becomes the main technique and method to explore an individual's world and social reality.<sup>3</sup> This study focuses on reconstructing the life trajectory of members of the most important urban oligarchic families, analysing the social behaviour and *modus operandi* of this social elite in southern Spain.

A close look into the institutions and the socioeconomic evolution of the Crown of Castile, of which the kingdom of Murcia was part, and its connections to the elites that were closer to court in Madrid and also to the kingdom of Portugal, allows the analysis of the *modus vivendi* and the behavioural patterns of the oligarchy in early modern Europe.<sup>4</sup> Specifically, this book explores the case of two families of the oligarchy, the Riquelme and the Fontes y Paz families, and analyses the behaviour and social evolution of the individuals involved in these families and their relationships with other oligarchical families during the *ancien régime* and at the turn of the nineteenth century in Spain. This is a study of the local, within the framework of microhistory, that also aims to better

explain the global-scale transformations that were ongoing in early modern southern Europe.<sup>5</sup> My goal is to understand and comprehend how members of the elite acted and moved through diverse social circumstances through the use of mechanisms and strategies that helped them maintain a closed society and also prevented lower estates from entering their high social stratum. However, as this book demonstrates, there were times and social contexts in which the group of families that were at the top of the social pyramid were not so closed among themselves. This social *mestizaje* (fusion) is the result of a social survival strategy where the oligarchy allied with emerging socioeconomic groups coming from the business world, who themselves sought to emulate the old oligarchy and move upward through the acquisition of nobility titles.<sup>6</sup>

Contrasts and contradictions defined European baroque society, making the study of the family and its evolution during different phases and times extremely complex. The idea of the 'group's interest' versus the 'individual's interest' is therefore fundamental in this analysis. The individual, in a hierarchised society such as the *ancien régime*, is not isolated, but rather follows a pattern or guide to be able to promote himself socially and have a high social, political and economic position in society. The concepts of lineage and the home thus emerged strongly. Individuals from the most illustrious and pre-eminent families of the oligarchy in southern Spain (the kingdom of Murcia) acted along the group patron's standards, who himself represented, preserved and symbolised the memory of the *fundador de la casa* (founder of the house), a common ancestor and mythical figure acting as image of a glorious past that itself extolled the lineage. The head of household was the *pater familias*, a superior figure to whom all other individuals of the family group were subject for protection. The concept of the family group or lineage must not be understood within the framework of the nuclear family or immediate family.<sup>7</sup> Rather, it is the affiliation and belonging to a group defined as more than one generation cohabiting in the same physical space or *casa* (house) and, in terms of the symbolic sphere, refers to the belonging given through blood and family ties embedded in old and noble families since the *Reconquista*.

Another suggestive and evocative term that will surface is that of social reproduction – a concept that reflects preservation and

permanency within the main institutions of power and the consolidation of the socioeconomic status of the family group.<sup>8</sup> Such a concept means perpetuation. In other words, social reproduction is the mechanism that social classes use to achieve reproduction and, ideally, a perpetual belonging to groups and families of power, who created specific strategies to reproduce, maintain and aspire to high status and an elevated level of patrimonial wealth mainly in Mediterranean Europe.<sup>9</sup> The Riquelme family, like most of the other lineages of the oligarchy from the time of settlement in the kingdom of Murcia in the thirteenth century, focused on social reproduction by remaining in the different conquered public powers – political, social, economic and religious, generation after generation.

In turn, there was an ideal of duration and perpetuity that manifested itself through memory, identity, representation and symbolism, terms that were reflected in perfect symbiosis between the individual and the collective within the group. It was the confluence of interests of the social actor closely related to those of the family group that boosted the symbolic capital of the family (in itself structured through kinship) as a collective institution. This study also shows that there were times of negotiation, tension and conflict when rupture and separation of interests between the individual and the collective or group occurred.<sup>10</sup> This internal disunity of the family group resulted in frictions and disputes within the lineage that weakened it and forced its social stagnation.

Marriage was among the strongest strategies and mechanisms used to counteract such social processes of immobilism.<sup>11</sup> Unions between important and powerful families, through studied and rigorous marriage arrangements, had it as their objective to maintain or augment the socioeconomic and political power of the families. Marriage meant relational capital, or the strengthening of blood ties between the powerful families, developing a new problem for the scholar, as kinship needs to be analysed in its social dimension. This book explains how the ties that connected individuals, the extent and frequency in which these links took place, are representative of the degree of patronage and clientelism developed among them and within family groups.

To reconstruct the intricate complex of social relationships that an individual goes through in his life-cycle, I use the sociological concept of 'social network analysis'.<sup>12</sup> Mapping out the social

network of *ancien régime* Mediterranean European society can prove difficult, however, owing to the scarcity of sources. But mostly the challenge arises because of the variety of social relationships that individuals develop, not only within their own high social stratum but also with middle and lower social groups. Though it may appear contradictory, this amalgam of social relationships is only the result of the set of interests and strategies that the lineage adopts as it adapts to certain social circumstances, with the aim of maintaining a balance of power among different social groups and maintaining and perpetuating itself.

Consanguinity, patronage, fictitious kinship, alliance, *paisanaje* (common local origin) and friendship are what sustained the ties and bonds mentioned above. Hence the network of relationships that the family generates is fundamental. Nevertheless, it is important to emphasise that elements of consanguinity and kinship are not always present when building a social network – in contrast, there were many cases where strong ties among ‘non-consanguineals’ (*allegados*), closely related individuals, were formed based only on solid friendship and patronage. Relationships were created, built, consolidated, and also contested, through conquering the different ecclesiastical and seigneurial powers, as well as those at court (as space for social promotion) surrounding the figure of the king.

The long-term framework and perspective (*longue durée*) is also central to this study.<sup>13</sup> By following the individuals’ life-cycles within local oligarchies and their lineages during long time spans, this book shows how social changes occurred from era to era, from medieval times to early modern, and also then to the modern era. Though this study does not attempt to present a definitive analytical method, or a solution to understanding social transformation, it calls for the scholarship of early modern southern Europe to broaden its temporal and spatial framework so that a comparative methodology can be used to include new case studies. Long-term approaches allow us to understand the role that family networks as power structures employed through time, and how the individuals and elites linked to them perpetuated their position in the public sphere. The key is to unravel such processes of adaptation or metamorphosis of the elites, analysing their ability to remain in power and gather new economic and political levels of power in each period.<sup>14</sup>

This book borrows from other fields of knowledge in the social sciences and the humanities such as history, economics, anthropology, sociology, modern languages, international studies and others aiming for broader, but also richer and deeper, conclusions that can shed light on the complex process that is social transformation. In addition, the contributions and continuous renewal of approaches to studying the family within history subdisciplines, namely global history, economic history and historical demography,<sup>15</sup> have recently provided significantly helpful models of analysis, enriching studies that focus on family reconstruction, the attention to the concept of life-cycle, the building of genealogies, and emphasis on social networks.<sup>16</sup> Within these fields, scholars have contributed to explaining and clarifying the complex mechanisms and the social processes of the *ancien régime*, shedding light on the complexity of how strategies and relationships in social groups operate where there is a system of both vertical and horizontal relationships, and interweaving this analysis with concepts of hierarchy, hegemony, patronage, clientelism and fidelity.

This research approach represents both continuity and renewal in regard to what we know about family life and economy, since it considers the family as the main social structure and thus the institution through which social changes can best be observed. The studies that advocate the combination of microhistory and global history have forced the revision of many generalisations in traditional scholarship about the impact that household and family groups and society played in large social, economic and cultural processes.<sup>17</sup>

In this sense, to determine the causes and the consequences of the entire process of change is arduous – the interaction of individual versus society, in its multiple formats, and how these operate at the core of the family, is a key factor in explaining social transformation. The permanence and the durability of family structures such as inheritance practices, sociability and a specific culture around genealogy, counterbalance the transition from the *ancien régime* to liberalism, and are fundamental in the study of change over time and of the transition from pre-industrial to modern societies. The extent of resistance generated from family groups and traditional institutions will determine the speed at which the change towards modernity occurs. Such a factor explains that, in western and eastern societies, the models of economic



development diverged during the first industrialisation, resulting in some more developed societies while others stagnated, as can be seen in the case of the northern and north-western European economies (United Kingdom, the Netherlands, and Belgium) on the one hand, and China on the other.<sup>18</sup>

The family as an important subject of study has been seen as a phenomenon that resulted from cultural, social, economic and political construction, rather than analysis of it in relation to the concepts of extended family, lineage, *paisanaje* and the institutions of the community in which the family lives. I thus argue that the family is the starting point in understanding the social, political, economic and cultural patterns in which the individual is involved in a specific period of time. The goal of historians who study the family should therefore be, in the case of Spain, to determine to what extent the family explains the evolution of Spanish society.<sup>19</sup> This book seeks both to build upon and to contribute to the scholarship that emphasises, and in some way renews, within the paradigms of microhistory and global history, the importance of analysing more exhaustively socioeconomic and cultural changes that occurred around the household and the domestic space. In the last couple of decades, the complexity of social changes has been well shown through the intense study of family groups and social actors. Scholars have demonstrated that this process of transformation is extremely slow and based upon strong and close relationships and social ties that had been forming for centuries. Thus I assert my claim to cross the hard chronological and disciplinary barriers that have contained the historian in straitjacketed perspectives, resulting in narrow and biased studies, both in regard to time and space, which have also created unclear conclusions and models to explain socioeconomic change in western and eastern societies.<sup>20</sup>

# Lineage Glory and Honour in the Late Middle Ages: Conquest and Consolidation of Economic Power

---

## 1.1. War, Power and Land: From the Middle Ages to the Early Modern Period (1265–1350)

The actions that the Riquelme family pursued in the last third of the thirteenth century to become part of the troops to conquer the kingdom of Murcia were in perfect alignment with the Castilian monarchy's reconquest campaign. The Riquelme would later settle in the kingdom after receiving the *donación* (donation) of lands and *heredamientos* (inheritances) that the crown provided in return for their services rendered during the conquest campaigns.<sup>1</sup>

The Riquelme lineage was a typical case of an outsider family that permanently settled in the kingdom of Murcia during the reconquest of the Iberian peninsula.<sup>2</sup> They were part of a larger group of the peninsula's Christian population that moved to the Murcian territory seeking easy riches and a comfortable way of life. Nevertheless, there were limits to their aims to increase their family wealth and estate. Among the difficulties that the new settlers faced and that truly hindered their socioeconomic development were the scarcity of land given, lack of resources to exploit the inherited properties, the limited productivity of the land and the lack of water.<sup>3</sup>

For legitimacy and real social advancement, the making of what can be defined as 'historical memory' began. Thus, among the

Riquelme family group, the concepts of lineage, family, political strategies, social reproduction and a hereditary system began to take shape around the framework of land possession in southern Spain. It was during the thirteenth and fourteenth centuries that the true lineage identity started to become coherent – and it happened around an already fixed heritage and estate, and an established surname. As James Casey says, ‘up until the thirteenth century, genealogies were like an entangled web from which a fortuitous man emerges from the average, makes a fortune and takes upon a lineage for himself, which is based on a last name that comes from the tower or town that he himself built.’<sup>4</sup>

The concept of the family provides a framework to analyse the acting mechanisms and the behavioural patterns of the individual, which he drew from the group’s interest. In the Castilian system, *las Partidas* (Divisions) show that the group was structured strictly in a conjugal fashion (husbands and sons).<sup>5</sup> However, some scholars have noted that the family, during the late medieval period, was already using specific mechanisms to build up a group that would be identified through lineage, which in itself was defined through close ties of kinship and common interests.<sup>6</sup> Kinship at the time was becoming a cultural phenomenon subject to the Church’s rules, established in Europe after the Fourth Lateran Council (1215), in regard to the degree of consanguinity – or real kinship – though these norms were not always respected.<sup>7</sup> Political strategies and social reproduction worked hand in hand, and they became extremely valuable in the late medieval period in providing the family with a true idea of group cohesion. In this sense, marriage was a fundamental tool in this process.<sup>8</sup> In Mediterranean Europe the social strategies that lineages used were based on setting up marriage alliances to ultimately place the family group on top of the social hierarchy, to socially reproduce the lineage and to avoid its biological depletion by establishing a perpetual succession line.

A bilinear type of succession defined the hereditary system of the late medieval period in southern Europe, one in which the individual and the group could choose which offspring path to follow – either female or male. However, the male succession line prevailed, opening the way to the emergence of the *mayorazgo* (entailed estate) in the Iberian kingdoms, *morgadio* in Portugal.<sup>9</sup> In turn, marriage strategies fundamentally shaped any inheritance

process and thus landownership became the main element of power among the nobility.<sup>10</sup>

Late medieval lineages cemented their idiosyncrasies within this edifice of ideas, and these also became central to their actions and *modus operandi*. During the early modern period in Europe and the Iberian kingdoms, the value of these concepts became even more grounded. Historians argue that ultimately lineage was nothing but a mental construction conceptualised around kinship, blood and the memory that needs to be materialised.<sup>11</sup> A late fifteenth-century Spanish chronicle by Fernando del Pulgar validates this affirmation, saying that in a world where everything is of divine origin, 'God created man but not lineages'.<sup>12</sup>

The case of the Riquelme family can be understood in this theoretical framework – they were a typical case of a group that gained wealth by their participation in conquest and benefited from the Castilian crown's donations of land that followed. From the first possessions acquired in the early land partition process, the Riquelme family accumulated an extensive estate that over the years, and especially at the threshold of the sixteenth century, placed them among the Murcian landowning nobility.<sup>13</sup> The origin of the Riquelme family in Murcia is dated in Riquelme manuscript of 1265 the year of the conquest of Murcia.

Guillén Riquelme entered victorious [and conquering] into that city . . . and he was designated heir in it, among 323 illustrious other knights and settlers as it is shown in that book by king Alfonso X the Wise (on page 4) . . . he was at the capture of the city of Orihuela, the town of Lorca . . . and he received lands as it is shown in his archives and population books.

In the time of king Don Ferdinand, when the king of Aragon James II took the kingdom of Murcia from him and then the king of Aragon expelled from Murcia all the knights that had followed the campaign of Don Ferdinand, and Guillén Riquelme was among them, he sought refuge with king Don Ferdinand who, when he went down to reclaim his kingdom of Murcia, brought with him Guillén Riquelme as the main captain of his troops . . . the king of Murcia entered and ordered the lands of Guillén Riquelme to be returned to him.<sup>14</sup>

As is common in sources of the early modern period, the language exaggerates and glorifies the family's past, aiming to provide magnificence and honour to the lineage. The same

document mentions that Riquelme individuals came from the great kingdom of France, from the house of Monfort, *señores* and counts of Tolosa. They came from the castle of Rodelas (city of Rochela) – Guillén de Monfort was among other wealthy men from France and Germany who came to the call of Don Pelayo.

Provided the *Ricoielmo* with weaponry and the piece of land where the Ricoielmo battle had taken place – that is, close to the valley of the castle of Maderuelo, and there is a place named Riquelme in memory of the battle. He was the captain of the Vizcayans, and he had a son that was Pedro Guillén de Monfort.<sup>15</sup>

The helmet in the Riquelme coat of arms has its origins in this event. The coat of arms shows a red field with a highlighted arm grabbing the helmet's plumed top ornament. The *celada* (crest), a symbol of defence, is the weapon that covers the head and represents life. The rest of the coat of arms confirms the achievement of the family's merits.<sup>16</sup> The chronicler Francisco Cascales wrote about this representation of the crest according to what Virgil declared in antiquity: “*Unun pro cunctis dabitur caput*” and “*pro capite pugnare*” is a proverb meaning to defend one's life – and to cover the head with the crest is to defend life with our weapons. The crest was the main weapon of the goddess and god of war, Pallas and Mars.<sup>17</sup>

Some notes about the origin of the last name Riquelme in royal letters mention that this family mainly settled in Murcia and that (though this is not completely certain) they had some origin in Genoa (Italy). The royal letters also reference the manuscripts of Don Miguel de Salazar, Juan de Buegas and Antonio de Varona, who wrote about the Riquelme and thus demonstrate *hidalguía*.<sup>18</sup> These notes are the only ones different from the notes written by Cascales. The remaining news that Cascales told and the royal letters are strictly the same – an indication that the information in the royal letters, dated in 1769, was copied from the news about the lineage that Cascales wrote about in 1621.<sup>19</sup>

However, the Riquelme manuscript was probably redacted before Cascales's *Discursos Historicos*, which makes the 1265 manuscript the first – and thus the most reliable – to mention the Riquelme lineage in the early modern period, with no other

objective but the glorification of the lineage. The three sources mention, in seeking to aggrandise the lineage, that

They came from the mountains in France with many others to support king Don Pelayo in his quest to conquer Spain; of which lineage there are great knights in Catalonia, in Jerez de la Frontera and in Murcia, who like others in earlier times tried nothing but to take back our Spain from the Moors and came looking for the opportunity of honour.<sup>20</sup>

This is how Guillén Riquelme became that glorious forefather of the lineage – his participation in the Castilian conquest of the kingdom of Murcia came to be the main form of validation and a source of honour and prestige for the lineage. Guillén Riquelme appears as one of the main settlers of the city of Murcia, and also the one, among other Riquelme family members, who received more land from the king of Castile, Alfonso X the Wise.<sup>21</sup> In the book of land partitions of Murcia during the thirteenth century, there are six secular individuals and two clergy documented whose social status was within the middle social strata of the new settlers of the kingdom of Murcia.<sup>22</sup> Two clearly different social categories appeared in the book: knights and *peones* (unfree labour subject to peonage).

Depending on their place in the social structure, each of these members of the Riquelme family received higher- or lower-quality lands. Part of what they received was high-quality *heredamientos* (inheritances) and irrigated lands by the Segura river.<sup>23</sup> Most of

**Table 1.1** Social structure of the Riquelme lineage

Name	Social status	Secular	Clergy
Guillén Riquelme	Lower knight	X	
Nicolás Riquelme	High-level peon	X	
Bernardo Riquelme	High-level peon		X
Martin Riquelme	High-level peon		X
Juan Riquelme	Middle-level peon	X	
Simón Riquelme	Middle-level peon	X	
Pedro Riquelme	Middle-level peon	X	
Berenguer Riquelme	Lower-level peon	X	

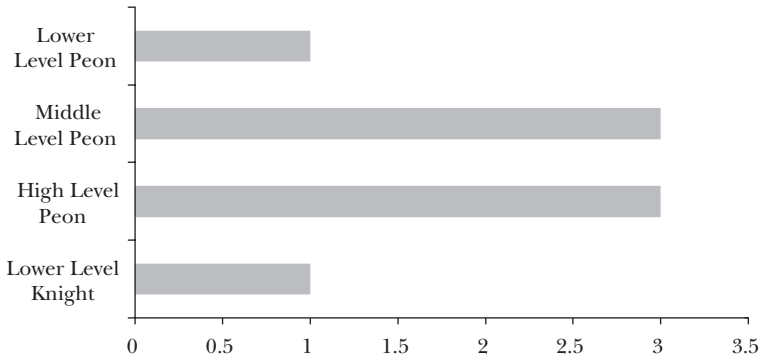

**Graph 1.1** Social structure of the Riquelme lineage

the land that they were given, a total of 88 *tahúllas* (measure of land in the kingdom of Murcia), was in the Cudiacibid *cuadrilla* (unit of land). This *alquería* was in the outskirts of Murcia, and it was divided into four types of land: the vegetable orchard (highly valued), a piece of land that needed manual irrigation, an *albar* section and a swamp section or *almarjal*.<sup>24</sup>

From the *heredamiento* (inheritance) of the five *alquerías* they received a total of 24 *tahúllas*, the lowest-quality piece of land that the Riquelme family received.<sup>25</sup> These lands were a semi-swamp, usually given to individuals of a lower social category. The Riquelme received a small portion of land of the lower quality – the Alfande area had both irrigated lands and gardens; the acquisition of Beniazor was a diverse section of mostly *albar*, though it could rotate with irrigation and vegetable gardens; and the Albadel region was the most sought after because of the quality of the land and the abundance of water; 105.5 *tahúllas* of irrigation land and 90 of *albar* in the Beninaya *cuadrilla* went to twenty-five settlers, middle- and low-level peon. There were other important irrigation zones like Benicot and Benicomay.

As shown in the chart of partitions, most of the lands that the Riquelme received dated to the third (1266–7) and fourth (1269–70) partitions. After the third partition, the Riquelme lineage maintained the lands that Alfonso X granted during the first partition. The king of Aragon James I's partition was ratified. The fourth and fifth partition completed each of the previous donations.

The Riquelme lineage began their venture in the kingdom of Murcia during the reign of Alfonso X. The settlement, however,

was interrupted during the reign of Sancho IV while Aragonese forces led by James II invaded Murcia. The king of Aragon expelled all knights loyal to the Castilian king, Ferdinand IV. Among them was Guillén Riquelme.<sup>26</sup> The Riquelme permanently settled in Murcia only after the Torrellas decision in 1304 that returned property and lands to the expelled Castilian groups. This time around, the Riquelme family consolidated an important amount of land and other properties in the orchard of Murcia.

Over time, in the fourteenth and fifteenth centuries, these possessions increased, not only in the irrigated land suitable for gardening areas within the limits of the city of Murcia, but also all around the kingdom of Murcia and especially in the border strip on the opposite side of the Nasrid kingdom of Granada. This location of both dry lands and irrigated territories was strategic for the definitive push in the reconquest. As with other sectors in the oligarchy, the power of the Riquelme family lay in landownership. The Riquelme belonged to the landowning nobility of the kingdom of Murcia, and it was around the process of land acquisition and possession, and also using marriage as a strategy, that the Riquelme crafted a network of family alliances.

The evolution and implementation of the system of lineages combined with all these bilateral factors had different chronologies and nuances in each territory.<sup>27</sup> This system is tightly related to the consolidation of the aristocracy and the gradual replacement of the old nobility by the new. The Riquelme were part of the new nobility as clientele of the Fajardo lineage.<sup>28</sup>

In the case of Murcia several factors came into play for this consolidation to happen. On one side, because the nobility disputes (Manuel against Fajardo) occurred in a borderland territory with Islam, war became an element for social promotion among the new lineages. On the other side, and closely related with the first, was the factor of the increasing *señorialización* (consolidation of lordship) in the territory. This was the creation of *señorios* (land property) during the late medieval period based on the occupation of unpopulated or uncultivated lands, most of them donated by the crown through the *concejo* as reward for services rendered in the battle against Muslims from Granada.<sup>29</sup> In parallel to the process of feudalisation, the creation of *mayorazgos*, by which a family avoids the dispersal of the family patrimony by structuring it around the first-born male, also increased. Based on all these



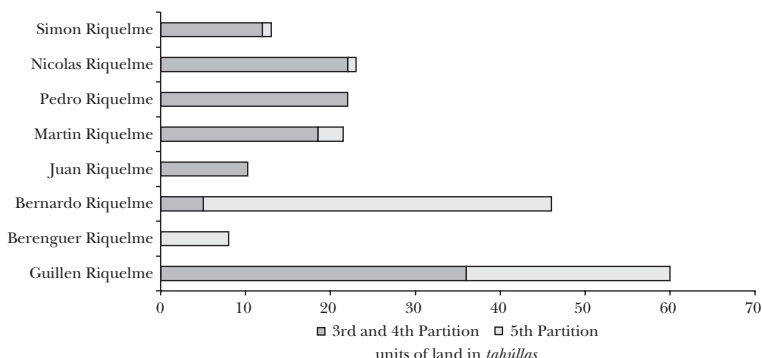

**Graph 1.2** Lands given to the Riquelme in the thirteenth-century land partitions (units of land in *tahúllas*)<sup>30</sup>

factors, lineage structures consolidated throughout the fifteenth century and were well embedded in society during the early modern period.

## 1.2. Consolidation of the Trastámara Dynasty: Reaching Economic and Political Powers (1369–1450)

Because of the scarcity of evidence to document this topic, primary sources are inevitably complemented by studies about the family and the nobility in the kingdom of Murcia published in the last several decades. Genealogy studies also play an important role in the process of reconstructing social trajectories of specific families and how each individual shaped their lineage.

Already in the early fourteenth century, chaos and bewilderment ravaged the kingdom of Murcia.<sup>31</sup> After the storm and the uncertainty, a new Murcian elite composed of cadres of new families settled in the kingdom. This process began when Guillén Riquelme, among other knights, travelled south to the kingdom of Murcia to participate in the conquest.<sup>32</sup> In reward for his participation, he became the first knight of the Riquelme family to hold a position in office. He was a *regidor* (member of the civic council) of Murcia and a *procurador* in court.<sup>33</sup> However, the occupation by king James II meant an interruption in the complete settlement of the family, though it resumed when Ferdinand IV took the realm.

In 1325, during Alfonso XI's reign, a *concejo* of forty *regidores* was created, marking the Riquelme's time to advance in the kingdom of Murcia. The *adelantado* named the *regidores* according to the decisions of the officials whom he also designated. This process was key to the new lineages in becoming part of the oligarchy. Little by little, by participating in the political life of the kingdom and by taking important decisions, they would gradually establish the sociopolitical reach of these 'new' families. The Riquelme were one of this new group of families holding *regidurías*, which also meant a period of renewal, both of *regidores* and *jurados* (city and *concejo* positions), and the assurance of gradual advancement and upward mobility of the families that achieved these posts.

Nobles and *hidalgos* used public office positions to be part of the old aristocracy. Having served in war to defend the crown was the most direct way to start participating in this process of social assimilation, and the process evolved and would be completed during the reign of Alfonso XI in the fourteenth century.

It is worth re-emphasising at this point that since the beginning of the fourteenth century and during most of the fifteenth, frequent disputes and fighting between families to obtain wealth and positions of power created a climate of convulsion and uncertainty in the kingdom of Murcia. However, 'new' families, the Riquelme among others, needed a leader with enough authority to help them accomplish their goals and see their expectations fulfilled. To do so, new families gathered and established alliances around the Fajardo family as the main lineage – the Fajardo were one of the most important lineages in the Murcian capital because of their close relation to the military order of Santiago and their kinship connections to the Ayala lineage.<sup>34</sup> Families united around the Fajardo to exercise more influence and to be immersed in new spaces of power.

For them, accessing positions in public office was the only path to power, and thus they gradually monopolised *concejo* positions which became their sole and most important aspiration. The Fajardo group was the best ally for the Riquelme in this purpose, since the Fajardo lineage was also on a mission to hold the post of the kingdom's *adelantado mayor*, from which both lineages (and other groups that supported the Fajardo) would benefit by obtaining more space and gaining more parcels of power. Another

obstacle that both the new families needed to defeat, however, was the Manuel lineage, a legacy of the old nobility.<sup>35</sup>

A form of clientelism emerged from these crossings rooted in reciprocity and mutual benefit between giver and receiver.<sup>36</sup> These families wove a thick net of relationships that resulted in a social network of sociopolitical interests, with marriage as the most important tool used to advance their sociopolitical interests.<sup>37</sup> The role of the *patrón*, or head of the lineage, was also of great relevance, as his leadership in the lineage translated as the public representative of the group's interest. Alonso Yáñez Fajardo held the headship in his lineage during the civil war between Peter I and Henry of Trastámara.

Peter I's supporters were a majority in Murcia during the armed conflict. The Fajardo lineage, with its clientele of noble families and the Riquelme as well, defended Peter I's claims. However, the outcome of the conflict was unexpected for this group: the accession of Henry II to the throne of Castile. Under the Trastámara dynasty the interests of the old nobility gradually began to dissipate, and the new nobility groups replaced the older ones. Luis Suárez Fernández has named it the 'Trastámara revolution'.<sup>38</sup> It was under the reign of Alfonso XI, with his *regimiento* of forty *oficiales* (individuals coming from the lowest ranks of the nobility), that the process of new families entering the spaces of political power was completed.

Nevertheless, in this social process, the Riquelme increased their achievements in public office, even with the change of dynasty.<sup>39</sup> They would become part of what historians have named '*trastamarista* nobility'.<sup>40</sup> But because of the dynasty change, the Riquelme had to shift strategies. They switched completely to the side of Henry II and deemed legitimate his right to the throne of Castile only so that the king would start favouring their cause. This 'Fajardo opportunism', changing loyalty from Peter I to Henry II and his noble followers, would be a political constant throughout the late medieval period and also in the early modern era.<sup>41</sup>

Henry II married the daughter of Don Juan Manuel, Juana Manuel. Don Juan had been named count of Carrión by Juan Sánchez Manuel, the *adelantado mayor* of the kingdom of Murcia. The specific goal behind this appointment was to reinforce royal authority in the kingdom of Murcia by implementing ordered and

organised politics in this territory. There was a personal objective for the count of Carrión as well: to strengthen the power of the Manuel lineage.

The Fajardo and their supporters saw the appointment as inevitably harmful to the interests of the Murcian oligarchy, which were focused on obtaining more parcels of political power and being as independent as possible of royal influence. The goal was to establish an access system to the *regidurías* compatible with their aspirations to power – a system to access, participate in and manage political power. The Fajardo and their clientele represented what the new nobility was looking for, while the groups around the Manuel lineage, on the contrary, were hindering the access of these families to a higher sphere of political power.

The *concejo* served as the stage where the factions disputed their supremacy.<sup>42</sup> The victorious group would control political life in the kingdom of Murcia. The emerging framework of tension and violence in which this battle evolved remained a constant during this period, with spells of time when tension eased, but still a ceaseless period of violence that lasted throughout the early sixteenth century.

The conflict between nobility factions contributed to increasing the dangers and instability in the kingdom. In addition, Murcia bordered Islam both by land (it was the closest territory to the Muslim kingdom of Granada) and by sea, exposed to the attacks of *berberisco* fleets from North Africa. All of these circumstances, living under constant danger and in a state of violence in the Murcian territory, made men at the time violent and rough, and that fury and rage shaped their way of life.<sup>43</sup>

The means and ways were not what mattered, even when these were implemented with violence, if the final objective – to take important parcels of power in the realm – was accomplished. In this case, the goal was to obtain the post of *adelantado mayor* and establish a restrictive access system, confined to a few families, to the *regidurías* of the *concejo*.<sup>44</sup> Medievalists have for long said that the violence of men, as of the natural elements, always comes to the surface and affects all human activity. Sometimes it is men against men. The desire to satisfy all wants meets obstacles, breaks legal and moral boundaries, and force is used, with malice, darkness, freedom from justice, and any means and tactics deemed necessary to achieve the ultimate desire.<sup>45</sup> The

event that Juan Riquelme recorded is good evidence of this description:

In the named *concejo* it was told and notified that on Saturday night when the sun was rising on Sunday, bad men had been drinking at the house of a woman known as the *mellada* of Joahan Riquelme, *cristiano nuevo*, whom they tried to kill and wanted to take sewn in a *seron* to be thrown into the river; however, this event became known to Gonzalo Rodríguez de Avilés, mayor, for the mayor to make justice according to law. And the *concejo* and the *oficiales* and good men required of the mayor to do justice according to law. And the *concejo* and the *oficiales* and the good men say that seeing that this event was bad and ugly, they required and confronted Gonzalo Rodríguez de Avilés, mayor, on behalf of the king, to let him know of the truth of this terrible event and to prosecute the malefactors for their faults; and we protest that if he does not do it, we will demand that the king intervene and require the malefactors to testify . . .<sup>46</sup>

There is other evidence of acts that the Riquelme family perpetrated in this era of violence and conflict. It is important to note as well that the late sixteenth century was a time of shortage and scarcity of commodities, mostly caused by political instability. Family groups that were slowly climbing the sociopolitical ladder took advantage of this volatility.

At times when scarcity coincided with prolonged looting and assaults by the *almogávares*, for example, the price of fish increased. Individuals with enough capital negotiated and speculated in the price of fish to increase their regular income at a time when the demand was assured. Juan Riquelme 'el viejo', *regidor* of the *concejo* between 1378 and 1391 and *alcalde* (mayor) at the *oficio de adelantamiento* for the *adelantado* Juan Rodríguez de Salamanca in 1407, in the midst of war against the Crown of Aragon, which deeply affected the stability of coastal regions, ventured to buy one hundred *jarras* (pitchers) of tuna that he later offered to bring to sell in Murcia if an appropriate, 'sufficient' selling price was assured to him.<sup>47</sup>

Francisco Riquelme, *regidor* (1414–20, 1424–30) and mayor in 1397, son of Juan Riquelme 'el viejo' and married to Isabel Gómez Dávalos, daughter of the *adelantado* Pedro Gómez Dávalos and niece of the *adelantado mayor* of the realm Alonso Yáñez Fajardo, was the protagonist in a similar case.<sup>48</sup> Through this marriage, which constituted a strong alliance between the family groups, the

Riquelme lineage had greatly advanced their already highly regarded position. Francisco Riquelme was earning among the highest incomes in the city and he also owned *cabañas* with twenty heads of livestock. Seeing the scarcity of meat in 1375, he brought some of his animals to the city to assure supply.<sup>49</sup> Powerful groups took advantage of crises at the end of the century to increase their private capital and continue establishing their control over the urban space.

In such a hostile climate, the disputes between the factions of the Manuel and the Fajardo lineages continued to escalate. The constant alteration of the system to access the *regimiento*, and the number of possible members who comprised it, caused multiple moments of extreme tension. In 1371 Enrique returned to Alfonso XI's system – a *concejo* of forty non-lifetime members. But the position of the *adelantado* Juan Sánchez Manuel in the Murcian capital was null, and the narrow and closed *fajardista* oligarchy finally restored a *concejo* of sixteen lifetime members. While Juan Sánchez Manuel maintained the *adelantamiento* away from Murcia, his opponents retained all effective authority. As the control of the Manuel lineage continued to decrease, the Fajardo gained more and more parcels of power. Evidence of this reinforcement of Fajardo control in the capital came when Juan Sánchez Manuel was completely humiliated at his bastard son Juan Sánchez Manuel, mayor of Cartagena, not being recognised *regidor*.<sup>50</sup>

Alonso Yáñez Fajardo's path to the *adelantamiento* of Murcia came when Juan Sánchez Manuel died in 1378. The new king, John I, named Alonso Yáñez Fajardo the lieutenant of the *adelantado*. The opposing faction still had alternative ways to continue striking against their opponents. The *fajardista* parties, following their aim to narrow the *regidurías*, reduced the number of *regidores* from sixteen to thirteen by not renewing positions when a *regidor* died – they had made *regidurías* lifetime appointments. By concentrating these positions among a small group of families, these families ended up controlling political power in the capital of Murcia and also sparked great resentment and envy among the low and middle patrician sectors. Juan Sánchez Manuel, the former *adelantado*'s son, knew how to take advantage of this, and he led an urban rebellion in 1391 that ended with the expulsion of Alonso Yáñez Fajardo and his followers from the city of Murcia. After such a major, unexpected setback to the Fajardo faction, their personal and real

**Table 1.2** Lands owned by Pedro Gómez Dávalos seized after the 1391 rebellion<sup>51</sup>

Property	Place	Value
1 house	'Calle Plateria' (San Bartolomé Parish)	1,000 <i>maravedies</i>
6 <i>tahúllas</i> of 'viña franca'	'Pago del Junco cabo el garrofero' (Orchard of Murcia)	
2,5 <i>tahúllas</i> of 'majuelo'	'Pago de Benimaguet'	Valued at 20 <i>celemines</i>  (10 of wheat and 10 of barley) annually for Francisco Celdran
1 <i>Heredad</i> 'franca' of irrigated land and additional farming land	By the Sangonera river, and sections by the rivers in the Sierra del Puerto, Cartagena.	
5 <i>tahúllas</i> of vineyard	In Villanueva, by a 'çequia regadera'	

property, including their cereal plantations, were also expropriated. An important set of *fajardistas*' lands like those belonging to the *adelantado* Pedro Gómez Dávalos was similarly seized.

In March 1391, the *Consejo de Regencia*, following what was stated in the *ordenamiento* of Alfonso I, and while Henry III was still a minor, provided the *concejo* with the traditionally held right to choose annually, among all the *hombres buenos* (good men) in the city, the *oficiales* who took positions in the *concejo*. From this time onward the *concejo* made the designations from a group formed by two *hombres buenos* from each parish.

Older *regidores*, who were easily accessing the *regidurías* and also pretending to be part of a close oligarchic body, were also expelled. Such was the case of Juan Riquelme.<sup>52</sup> His family, like others from the local oligarchy, had achieved an acceptable income level by going up the social hierarchy. The Riquelme's gradual advance stagnated for some time, however, after this severe setback.

However, all these events ended up being only a sort of illusion for the Manuel faction, since their standing was already weak and had been experiencing many internal frictions. A sign of this was Juan Sánchez Manuel's opportunism: in 1391 he fled the capital and made a pact with the *adelantado* to participate in looting harvests and destroying irrigation fields built just that year.<sup>53</sup> In this context, the monarchy knew that their own fate was connected to that of the *fajardista* cause, which made the crown send a *corregidor* to the capital before getting rid of the services of the *adelantado* Alonso Yañez Fajardo. On behalf of, and to enforce, royal authority Ruy Méndez de Soto Mayor was sent to the capital in 1394.

Families then set up alliances with each of the factions. There were entire families supporting the Fajardo, especially the families representing the eleven expelled *regidores*: Magán, Muñón, Ponce, Sánchez de León, Fernández de Toledo, Riquelme, Peñaranda and Junterón. The disputes between the two factions worsened at the time, with the Fajardo gradually gaining control against the slowly diminishing power of the Manuel lineage. Mula's, and specially Lorca's *concejo*, were the first two groups where the Fajardo found refuge and support.<sup>54</sup>

A series of concatenated events meant the final failure of the Manuel group and the triumph of the Fajardo. Among these were the appointment of Ruy Méndez de Soto Mayor as *adelantado mayor* after the death of Alonso Yañez Fajardo in 1395, the institutional reforms in the *concejo* in the fifteenth century – with the gradual aristocratisation of the institution as a result – and the 1401 expulsion of Juan Sánchez Manuel. The interest of Dávalos in finding in the Fajardo a popular base to maintain the city, the '*omes buenos . . . e llanos*', and to consolidate as a new lineage against the old nobility personified in the figure of Juan Sánchez Manuel, was obvious.

The Riquelme family wanted to reinforce and strengthen their alliance with the Fajardo by approaching the Dávalos lineage. The marriage between Francisco Riquelme and Isabel Gómez Dávalos, as well as the marriage between the *adelantado* Pedro Gómez Dávalos's daughter and the *adelantado mayor* Alonso Yañez Fajardo's niece, were key to the future of the Riquelme lineage. Through their marriage strategies, the Riquelme lineage gradually became more relevant in the political life of the kingdom. They were part of the Fajardo clientele that exercised the role of the *patrón* of the



lineage. Antoni Maczak subtly points out that ‘the patron–client relationship was a medieval heritage’ which was common in southern Europe.<sup>55</sup>

Political power became finally Fajardo-driven with the appointment of Alonso Yañez Fajardo II as *adelantado mayor* of Murcia in 1424. The triumph of this lineage also meant that other families like the Riquelme were victorious in their long-awaited goal of appointing lifetime *regidurías* controlled by only a few families. The 1424 order by John II to establish only sixteen *regidurías* ruled by lifetime members represented the final triumph of the Murcian oligarchy.<sup>56</sup> Not in vain, it was evidence that during the reign of John II the Riquelme took over more and more seats in the Murcian *concejo* and greatly advanced in the sociopolitical sphere of the kingdom.<sup>57</sup>

Francisco Riquelme, who was the *alcalde* (1424–30), on behalf of the noble estate, was appointed as one of the sixteen *regidores perpetuos* (lifetime) that John II institutionalised in 1424. His brother experienced something similar – Bernardo Riquelme, holding the post between 1420 and 1424, and Diego Riquelme, *regidor perpetuo* from 1432 to 1480.<sup>58</sup> Likewise, at the beginning of John II’s reign, the uncle of Diego and Bernardo Riquelme, Juan Riquelme ‘*el mozo*’, was *regidor* for a year in 1408.<sup>59</sup> By this time, it was sufficiently proved that the establishment of a restrictive access system in the *regidurías*, by making the posts lifetime positions, was a watershed event in consolidating the Riquelme family as one of the most powerful groups in the kingdom of Murcia.

### **1.3. Service at the Frontier: ‘Land Warriors’ as Major Landowners of the Crown (1369–1520)**

By the mid-fifteenth century, the lineage system was fully embedded, developed, and consolidated in Castilian society. Its establishment varied, depending on the territory, however.<sup>60</sup> Murcia’s border was with the kingdom of Granada, and as a frontier territory it acquired distinct nuances.<sup>61</sup> And, as explained in the previous sections, the disputes between nobility factions to obtain as much control as possible were one of these nuances.<sup>62</sup> The tension between the Manuel and the Fajardo groups, and all the clientele behind them, was a good example of this. Among

the factors involved in understanding the consolidation of the Castilian aristocracy, in the case of Murcia, are the geostrategic space of this kingdom.

The conflict between factions never disappeared in Mediterranean Europe. On the contrary, tensions now were at the heart of the lineage as they were intrafamily disputes. This section focuses on the relevance of the kingdom of Murcia as borderland territory in Europe.<sup>63</sup> Murcia marked the line between two religions, Islam and Christianity, and the battle against Muslim incursions became the ideal frame for the process of social advance that a high number of families pursued at the time.<sup>64</sup> By providing military services to the crown at times of war they continued to receive *gracias y mercedes* (graces and grants) in compensation.<sup>65</sup>

The frontier factor was tightly connected to the process of feudalisation of the land – after a part of the land was occupied and freed of attacks from the invader, the creation of *señoríos* (lord-owned lands) connected to wealth and family property took place. The case of the Riquelme family and the services they provided at the border with the kingdom of Granada is a good example of the connections between war and the following foundation of the *señoríos* of Santo Ángel (in the Murcian orchard) and Campo Coy (in the Lorca lands).<sup>66</sup>

During the early years of the fifteenth century, the *caballería* (cavalry) found itself in a very conflictive situation. Traditional *caballeresco* (cavalry, knight) values were losing meaning, and knights were more and more seen as mercenaries that only went to war – knocking out and destroying everything on their way – for monetary remuneration.<sup>67</sup> Based on the Chronicle of Alfonso XI, ‘The cavalry has not only lost their ethical principles, but also its traditional function and the spirit of belonging. The only thing that distinguishes knights from those who are not knights is lineage.’<sup>68</sup>

One of the most important objectives during the reign of Alfonso XI was the renewal of the ethics and the military strategies of the cavalry through the reactivation of war against Granada. The border was a moving line in which small clashes between the two sides took place. The previous loss of pride as members of the cavalry came back by recovering the military qualities or, in other words, by continuing fighting activity with the most noble of its meanings in mind – as written in the *Poema de Mio Cid* – and against

Islam.<sup>69</sup> As George Duby explained, in the European Latin world, three phenomena had come together since the eleventh century: first, the expansion of feudal landownership; second, a new method of appointing knights had been evolving; and as result, third, an emerging bellicose period was developing.<sup>70</sup>

The need to reinforce the new model of war was through European cavalry. Alfonso XI tried to resume the reconquest by creating a large-scale enterprise that had not been seen since the one Sancho IV formed for Tarifa. However, the monarch had trouble recruiting troops. At the time, the ongoing process of the decline in *caballeresco* values was aggravated by being close to the border, which was a location noted for looting, traffic and illegal trade of goods not allowed to be exported from Castile.<sup>71</sup> In 1348, Alfonso XI implemented the *Ordenamiento* of Alcalá to provide a legal frame to his goal of updating the *caballería villana* (cavalry from the towns). The cavalry was armed with the idea that knights would maintain their horses and armour depending on their amount of property. The ultimate goal was to 'be ready and prepared for war against the Moors'.<sup>72</sup>

A consequence of this legislation was the gradual assimilation – and confusion among *caballeros* – of the *caballería popular* (people's cavalry) and the one based on lineage. This process of social assimilation, beginning with the land partitions of Alfonso X when families from the middle strata began to gain wealth, reached a new height as recruitment needs increased in the fourteenth century. As expected, it was difficult for those in the higher ranks of society to accept this assimilation of the new and the old nobility, and this became an important trigger for nobility disputes.

Though this is a highly debated issue in recent historiography, the idea that the new urban oligarchy advanced through war and because of the permeability of the most powerful groups has been widely accepted.<sup>73</sup> The emergence of the *patriciado caballeresco* (patrician knights) was rooted in urban knight culture, and this group was formed by individuals with important positions in public office who also counted on the support of their own lineages and power groups.<sup>74</sup> The Castilian *patriciado* was different from the rest of Europe's in that it was grounded in the socioeconomic base of war and land, based on a perfect symbiosis of material foundation and ideological principles. As Jiménez Alcázar said, 'prestige acquired as much loved intrinsic value as money does.'<sup>75</sup>

The Riquelme followed the model of this group of *caballeros villanos*. The families in this lineage were part of the conquest and settlement efforts in the kingdom of Murcia. The donations from Alfonso X's *repartimientos* were just the beginning of a process of land accumulation that gradually increased the family's wealth and thus their access to appointments in the *concejo* and especially in the *regidurías*.

The later alliance with the Fajardo and the legal frame that Alfonso XI defined to advance war in 1348 enhance the evidence about the Riquelme being part of this new social group of *caballeros cuantiosos*, whom Sobaler Seco calls *gente nueva* (new people) in the case of Soria or *hombres nuevos* (new men) if we use José Ángel Lema Puedo's terminology of his studies of the Guipuzcoan elites.<sup>76</sup> They entered the new social layer of the nobility that displaced the old one. Other evidence that confirms the completion of this process was a *concejo* tax on neighbours with the highest incomes in Murcia. The *padrón de cuantiosos murcianos* (census of wealthy individuals in Murcia) that parishes collected shows that the Riquelme group was among the wealthier in the city.<sup>77</sup> War was the group's main tool for social promotion during the late medieval period. The participation of the Riquelme in the campaigns that the Castilian monarchy led in the last third of the fourteenth century and in the fifteenth helped the lineage rise to the top of the social pyramid.

The campaign in Portugal to recognise John I as sovereign of the kingdom that started in 1348 was the first example of this phenomenon.<sup>78</sup> The Castilian crown's effort was disastrous, and the troops were almost all lost. The battle of Aljubarrota aggravated the defeat, and also the deep economic crises that followed in Castile, though these armed conflicts were not so unfortunate for the Riquelme because John I, and the Trastámara monarchs afterward, recognised and appreciated the group and their services rendered.

King John I immediately began to send recruiting letters ordering *concejos* to start enlistment of troops.<sup>79</sup> The orders sought to recruit as many troops as possible, avoiding extensive exemption, and this is why many *hidalgos* (lower nobles) were called to arms.<sup>80</sup> However, many of the *hidalgos*, especially from the oldest families, evaded the call believing themselves exempt from military service on the payment of *pechos* and tribute – they argued

that their interests as a privileged estate would be damaged by going to war. By contrast, the *caballeros villanos*, who had been assimilated into the old *hidalgo* families, agreed to participate in the campaigns.

Since the time when Alfonso XI enacted the Alcalá regulatory measures to relaunch war and reconquest, a process of *mestizaje* within the old body of the nobility had been taking place as the *caballeros villanos* equated their status to the *vieja nobleza* and went even further. The social body of *hidalgo* families also became more diverse as a result, which has generated some confusion in the historiography of the last couple of decades.<sup>81</sup>

The new (assimilated) families agreed without hesitation to participate in war to increase their prestige and social status. In the Riquelme case, a letter from John I when he was in Almeida said: 'Juan Riquelme, *regidor* for the noble estate, agreed to place *bastimentos* by the walls because there were rumours that the English who were coming to defend Portugal wanted to attack the kingdom of Murcia first.'<sup>82</sup>

Likewise, Juan Riquelme's son, Francisco Riquelme, *alcalde* for the nobility and *regidor* of Murcia, who had been ordered to take care of the border, assisted John I in the Portugal campaign with 1,500 gold *maravedies* (Muslim currency).<sup>83</sup> The letter to recruit in Murcia had ordered the enlistment of everyone who had obtained the title of *hidalgo* since the death of Alfonso XI.

The overall result of this campaign was the decline of Castilian aspirations to conquering Portugal. However, the novel participation of some new families like the Riquelme was rewarded with substantial benefits. The monarchy recognised them, and this helped their gradual entrance to court.

### 1.3.1. Participation in the Campaigns of Granada: Expanding Land and Ownership

The Fajardo, as a *fronterizo* group, and led by the *adelantado mayor* of Murcia Alonso Yáñez Fajardo II, played a crucial role in the last period of reconquest in the Iberian peninsula. They supported a number of urban oligarchic families (the Riquelme family was one of them) to be constantly active at the border in ultimately conquering the kingdom of Granada.

The *adelantado mayor* position, the most important political appointment in the kingdom, was in the hands of the Fajardo

group, and after the marriage between Francisco Riquelme and Isabel Gómez Dávalos, niece of the kingdom's *adelantado mayor*, Alonso Yáñez Fajardo, the Riquelme were inside the power orbit. This family and political union helped the Riquelme greatly to get important appointments in the *adelantamiento* of Murcia.<sup>84</sup>

Constant armed conflict between Christians and Muslims from the Nasrid kingdom of Granada made the border a highly unstable place.<sup>85</sup> Added to the internal battles in the kingdom and the battles against Muslims on the southern border, a climate of 'general militarisation' spread throughout the territory during the fifteenth century. In medieval Europe, and mainly in the Iberian kingdoms, the border enhanced the role of the warrior and developed a war economy. This ended up generating wealth through the frontier activities and created opportunities for social promotion and a redistribution of property that enriched some and impoverished others.<sup>86</sup>

The reconquest marked the constant redrawing of the border at the time. For example, during the first half of the fifteenth century, the area that went beyond the municipal limits of Lorca (the lands of Baza, Huéscar, Guadix and the valley of Almanzora) became geostrategic locations.<sup>87</sup> The conquest of all forts and walled cities meant progress for Christians over Islam and a meaningful impulse towards the final objective of conquering Granada.<sup>88</sup> In 1435, Alonso Yáñez Fajardo II conquered the strategic rearguard and also forefront *plaza* of Huéscar, La Sagra, which brought him great prestige in the conflict of Christianity and Islam.<sup>89</sup>

The death of Alonso Yáñez Fajardo in 1444 generated strong internal conflicts in the lineage, and as a result the loss of the already conquered locations and the retreat of the border to the limits of 1430, with the exception of Xiquena.<sup>90</sup> The title of *adelantado* went to the first-born son of Alonso Yáñez, Pedro Fajardo. However, Pedro's cousin, Alonso Fajardo '*el bravo*', claimed possession of the same title. As a continuity of the lineage disputes that had been common since the late medieval period, this resulted in yet another open battle between the family factions. This time the disputes emerged within one lineage, but such a civil-war type of conflict between 1440 and 1461 marked a slackening in the ongoing effort to conquer Granada.

The disputes between the Soto and the Riquelme families in the sixteenth century could well have their origins in the intrafamilial

conflict that took place within the Fajardo lineage. The Soto faction was closer to Alonso Fajardo *el bravo's* cause.<sup>91</sup> Diego de Soto, *comendador* of Moratalla, led the opposition against Pedro Fajardo, though it was rapidly repressed. The peace signed in 1449, which the crown mediated, was over when Fajardo '*el bravo*' left Murcia to defend Lorca from Muslim forces at the Granada border. The battle between his troops and the Muslim forces ended with victory at Alporchones in 1452, where the followers of Pedro Fajardo did not respond to his call for help. It was, however, Diego Riquelme, son of Francisco and Isabel Gómez Dávalos, who assisted John II in the battle.<sup>92</sup>

This is evidence of the ambiguous position that the Riquelme family adopted inside the Fajardo lineage. Depending on the political context and the events happening at the time, they would be closer or farther from the head of the lineage who was then holding the main position in the kingdom, the *adelantamiento*.<sup>93</sup> In their actions there was always the conviction that by serving the Castilian monarchy they would advance their social and political position.

With Alonso Fajardo in exile in 1461, the Riquelme strongly supported the *adelantado* Pedro Fajardo. The disputes between the Soto and Riquelme groups were a continuation of the battles between factions generated by the conflict between Alonso Fajardo *el bravo's* supporters and those supporting for the *adelantado mayor* Pedro Fajardo.<sup>94</sup> The jealousies of the late medieval era between the Soto and the Riquelme families was resurrected in the early modern period.

In favour of his infant brother Alfonso, Pedro Fajardo supported the nobles who dethroned Henry IV in the mock ceremony of Ávila in 1465. When Alfonso died in 1468, this group of nobles did not recognise Henry IV as the rightful monarch. The same ambiguous position was present in the Riquelme lineage in a client group of the Fajardo (led by the *adelantado* Pedro Fajardo), through the figure of Alonso Riquelme, brother of Diego Riquelme.

Alonso Riquelme served king Henry IV as captain in the reapture of Cartagena, which was in the hands of Don Beltrán de la Cueva. Diego Riquelme helped to counteract the de la Cueva uprising as captain of another enterprise. The monarch honoured these acts by designating Alonso Riquelme *alcaide* of the Castle of Cartagena, and granting him the administration of *censales*

*perpetuos* of the Order of Santiago, as stated in the royal provision.<sup>95</sup>

The Riquelme knew exactly how to design their political strategy and play their cards. On one hand, they got closer to the *adelantado* that held the kingdom's political power and maximum authority. At the same time, this lineage resented any kind of royal intervention in Murcian territory. On the other hand, they continued supporting the Castilian monarch, knowing that by serving the crown in military matters, they would end up achieving their ultimate objective of bringing the lineage to the highest social level and being part of the court.

In the conflict of crown and nobility, the Riquelme knew not to choose completely one or another side – it was better to play their hands and gain the most benefit for the family group. This allowed the Riquelme to introduce themselves into the regional nobility groups to obtain *señoríos* and to accumulate land, the source of both power and wealth.<sup>96</sup> As a result of the ascending trajectory in the political, economic and social spheres, Diego Riquelme became first lord of Santo Ángel.<sup>97</sup> This was a group of both *campo* and irrigated lands in Murcia, a formation dated to the mid-fifteenth century that became linked to the Riquelme through the *mayorazgo*.<sup>98</sup> The benefits gained by the group's socio-political strategies, which were already notorious in the fifteenth century, became even greater with the establishment of the Catholic monarchs.

The main goal of the new monarchs was to push for the definitive conquest of Granada. To obtain a *bula de cruzada* from the Papacy that would endow the enterprise with prestige and also cover the costs of war, the monarchs argued that they were fighting the infidel.<sup>99</sup> The strategy was formed by a number of initiatives to end the permanent Muslim threat. The main nobility lineages saw the Granada campaigns as a chance to promote themselves socially.

The border, the dividing line between Islam and Christianity, was the geographic space where more promotion and upward mobility processes through war took place in the last decades of the fifteenth century. The medieval mentality of war as something that ennobles was clear in European kingdoms at this time, and the case of the Riquelme family is a good example of this phenomenon. At the beginning of the Castilian initiative over the border, starting in 1480 Christians advanced successfully, particularly in



1488–9 with the conquest of Huéscar, Huércal-Overa, Vélez, Vera and Baza.

Pedro Riquelme, second lord of Santo Ángel, served the Catholic monarchs in the conquest of Baza, where he was taken captive.<sup>100</sup> His cousin, Martín Riquelme represents the clearest example of the advance of the lineage under the rule of the Catholic monarchs. He was *paje* and *copero mayor* of Ferdinand and queen Isabella – thus being the first in the lineage who connects directly with the court and its space of influence and power. A rigorous marriage strategy, explained in detail in chapter two, explains this better.

Martín Riquelme served the Castilian crown in the campaigns of Portugal and Granada as *capitán de lanzas*. He participated, taking the city of Alhama when he defeated the Muslim troops in the *villa* of Aledo around 1488. Afterwards he was appointed *regidor*, *procurador en cortes* and *alcaide* of the *villa* of Ricote. For his appointments and battle triumphs the Catholic monarch called him Martín Riquelme ‘*el valeroso*’. The sources also mention him as the head of the faction opposing the Soto lineage. The rise of the Riquelme during the reign of the Catholic monarchs was an added element to the mix that provoked the resentment of the Soto lineage against them. Martín Riquelme’s brother was also *paje* for the Catholic monarchs, being *gentilhombre* and residing in the royal home, and he was also *capitán de caballos* in the wars of Granada.<sup>101</sup>

In this line of argument, it is worth emphasising Joseph Pérez’s statement that ‘the war in Granada was a way to mobilise the nobility around the sovereigns and to serve the state. Noble status was awarded to many soldiers who played a distinguished role on the battlefield. As in the heroic times of reconquest, war brought the opportunity of upward mobility and access to the privileges of the aristocracy. As in the era of the *Cid*, honour and wealth were granted at the time.’<sup>102</sup>

During the final years of conquest, this process took place more intensely in the border territory, which was usually depopulated. The awards by the *concejo* of Lorca in the frontier area were especially significant.<sup>103</sup> Concessions were given to individuals who stood out for their military character and their role in the reconquest. Such was the case of the Campo Coy census, which was first in the hands of the Fajardo in the time of the reconquest, and later, in the first third of the sixteenth century, changed hands to the

Riquelme group after the sale and *heredad* (distribution) made by Alonso Yañez Fajardo 'el africano', bastard son of Alonso Fajardo 'el bravo'.<sup>104</sup> From then on, they constituted the property as a *señorío* connected to family property through the *mayorazgo*. In this way they became lords of Coy – Diego Riquelme was first lord of Campo Coy.<sup>105</sup>

The conquest of Granada ended the fighting on the border, and it also meant that noble families saw their patrimony augmented. Some of the new properties were the crown's reward for services rendered during war, and others came from purchases between private individuals. This is when noble landowners began consolidating their control and influence of the kingdom of Murcia. The expansion across the frontier and the accumulation of wealth, with the Riquelme family playing a large role in the process, was the preamble for the foundation of *mayorazgos* during the sixteenth century and throughout the early modern period.<sup>106</sup>

The four factors that allowed the completion of the establishment of the lineage system were thus clearly defined: first, the nobility disputes; second, the fact that Murcia was a frontier territory; third, the well-developed process of *señorilización* (consolidation of lordship); and fourth, as a result of the completion of reconquest, the immediate linking of land to family name through the creation of *mayorazgos* across the kingdom.<sup>107</sup> By the start of the sixteenth century, the imaginary of the elite with a clear lineage consciousness had been consolidated.<sup>108</sup> And all the glorious moments and events that occurred in war during the last phase of Christian reconquest contributed, throughout the early modern period, to nobles constantly boasting of their ancient lineage which had participated in the campaigns to conquer Granada from the Muslims.

Francisco Cascales, in his *Discursos Históricos*, described how the deeds were embodied in material culture, the writing of *memorials* and with shields and crests ornamenting nobles' homes and palaces.<sup>109</sup> And, as some scholars have pointed out in regard to this issue, these material elements demonstrate a shallow exhibition of the antiquity, honour, splendour and virtuosity of their lineage, all related to the good and pure blood inherited from their ancestors.<sup>110</sup>

The nobility increased both its social and economic power during the reign of the Catholic monarchs. Many nobles took

advantage of the distribution of lands after the conquest of the kingdom of Granada.<sup>111</sup> 'All the *grandes* (old nobles), knights, and *hijosdhalgo* that served in the conquest of this kingdom', wrote a contemporary chronicler, 'received rewards of houses, land and subjects, depending on their estate.'<sup>112</sup> Most of the *grandes* benefited from the laws enacted in the court of Toro in 1505, when their right to *mayorazgo* was implemented and regulated.<sup>113</sup> And as John Elliott explains, the majority of the nobles chose not to become court nobles, but rather to live in their 'sumptuous palaces' and 'large land properties'.<sup>114</sup> The Riquelme were, however, an exception: they established themselves at court with the Catholic monarchs and all through the reign of Charles V. At the same time, they used the *mayorazgo* to link their extensive land properties to their family patrimony during the entire early modern period.<sup>115</sup>

### **1.3.2. Participation in the Campaigns of Italy and Africa: The Consolidation of Power**

War in Granada shaped Spain's building of the modern state. It strengthened and provided the state with first-class armed forces that would immediately afterwards show their abilities in Italy.<sup>116</sup> This consolidated the power of Spain in Europe. The Granada enterprise brought the Catholic monarchs in Spain the chance to modernise its military, and to perfect its technical prowess and its equipment.<sup>117</sup> Gonzalo Fernández de Córdoba, the *gran capitán* (great captain) of the wars in Italy, learned his military tactics in the Granada campaigns.<sup>118</sup>

The conquest of Granada in 1492 allowed king Ferdinand to pursue more military endeavours. The invasion of Italy by Charles VIII of France led to a coalition of European forces to stop the French monarch. The *Liga Santa* (Holy League) was created in 1495 between England, Spain, the Empire and the Papacy, and in the words of John Elliott, the agreement marked a 'triumph of king Ferdinand's foreign policy'.<sup>119</sup> Since then, the Castilian monarch had established the foundations for a diplomatic system that maintained Spain's hegemony for a century. With the goal of blocking France by diplomacy, between 1480 and 1500, he established permanent embassies in Rome, Venice, London, Brussels and at the Austrian court.<sup>120</sup> The success of Spanish foreign policy was the establishment of a diplomatic network.

The Riquelme lineage became part of this dynamic through the experience of the appointments they held after the conquest of Granada. The group supported the crown's actions after the war. Cristóbal Riquelme, third lord of Santo Ángel, knight of the Order of San Juan became the ambassador to Rome. Charles VIII's invasion of Naples around 1495 made clear that diplomacy and military action needed to complement each other. *Gran capitán* Gonzalo Fernández de Córdoba led the Italian campaigns, and the Riquelme also helped in Italy – Luis Riquelme, father-in-law of Cristóbal Riquelme (third lord of Santo Ángel), was *capitán de caballos* in the wars of Naples.<sup>121</sup> The French were defeated in 1504 and the Spaniards became the official owners of Naples.

The Neapolitan campaign showed that, in the early sixteenth century, both the state's diplomacy as well as its military were now professional and thus two essential pillars of the modern state. The Riquelme were active on both fronts, which explains their social advance in the first third of the sixteenth century in a bonanza of benefits that most of the noble families experienced at the time. The power and prestige that each of the members of the group achieved through their individual actions, by participating in the campaigns, serving the king in the court, accumulating posts in the *concejo*, increasing their wealth by accumulating land, or by holding the crown's foreign diplomatic appointments, also helped the group to the top of the social hierarchy. There was a real group consciousness by then, of being part of the urban oligarchy, and through the group the individual was socially promoted. Without the group, the individual would not have enjoyed these benefits.

All of these factors helped the Riquelme maintain their place in Charles V's court as well. Lorenzo Riquelme Barrientos served the court of Charles V's brother, Ferdinand I of Habsburg, and he was Charles V's *guardia mayor*. Martín Riquelme 'el soldado' was *paje* of Charles V and also participated in his African campaigns of Algiers and Bougie.<sup>122</sup>

The analysis of all this trajectory, both at the political and the military levels, demonstrates that the Riquelme possessed high social prestige during the first half of the sixteenth century, and especially after they served in the military campaigns of the Castilian crown. After the wars in Granada and the victory of the Hispanic monarchy, the campaigns in Italy offered the group a new opportunity to rise. The group dignified itself through

participation in diplomacy and military actions. The campaigns in Africa that followed, which were conceived as continuations of the reconquest, gave yet another chance to the lineage to show their position, though here the aggressive Castilian monarchy was not so successful.

The high number of appointments in the *regidurías* and also the position as *regidores* that Riquelme families held were relevant evidence of their social and political advance, and this tendency continued to rise as a result of their participation in the *concejo* during the reigns of the Catholic monarchs, Charles V and Philip II (see table 1.3 and graph 1.3). Throughout Philip II's reign the lineage was further strengthened as the crown faced economic stagnation by selling public office posts, and as the Soto lineage declined. This was the Riquelme's most splendid era, one of great power in the urban oligarchy (see figure 1.1).

**Table 1.3** Public office positions held by the Riquelme family, thirteenth to sixteenth centuries<sup>123</sup>

Name	Position	Place	Date
Guillén Riquelme	Regidor, Procurador de Cortes, Capitán de lanzas	Murcia	second half 13th c
Alonso Riquelme	Regidor	Murcia	first half 14th c
Juan Riquelme 'el viejo'	Regidor	Murcia	1378–91, 1399–1404
Bartolomé Riquelme	Regidor	Murcia	1403
Juan Riquelme 'el mozo'	Regidor, Alcalde de Adelantado	Murcia	1408–9
Francisco Riquelme	Regidor	Murcia	1414–20, 1424–30
Alonso Riquelme	Capitán de lanzas, Alcaide, Teniente de Adelantado	Murcia, Cartagena	1455, 1459, 1474

**Table 1.3** Public office positions held by the Riquelme family, thirteenth to sixteenth centuries<sup>123</sup> (*Continued*)

Name	Position	Place	Date
Luis Riquelme	Paje, Capitán de caballos	court Catholic monarchs, Granada	last third 15th c
Luis Riquelme	Teniente de Adelantado, Capitán de caballos	Murcia, Naples	end 15th c
Martín Riquelme 'el valeroso'	Regidor, Procurador de Cortes, Capitán de lanzas, Alcaide, Paje, Copero	Murcia, Ricote, court Catholic monarchs	1482, 1488
Martín Riquelme 'el soldado'	Regidor, Paje	Murcia, court of Charles V	1508, first half 16th c
Lorenzo Riquelme Barrientos	Guardia mayor	court of Charles V	early 16th c
Cristóbal Riquelme	Ambassador	Rome	early 16th c
Diego Riquelme	Regidor, Capitán de lanzas, first lord of Coy, Teniente de Adelantado	Murcia	1479–82
Cristóbal Riquelme de Comontes	Regidor, Teniente de Adelantado	Murcia	1579–84
Alonso Riquelme de Comontes	Second lord of Coy	Murcia	first third 16th c
Diego Riquelme de Comontes	Regidor, third lord of Coy, Teniente de Adelantado	Murcia	1565, 1569
Cristóbal Riquelme de Comontes	Regidor, fourth lord of Coy	Murcia	1592–1604

**Table 1.3** Public office positions held by the Riquelme family, thirteenth to sixteenth centuries<sup>123</sup> (*Continued*)

<b>Name</b>	<b>Position</b>	<b>Place</b>	<b>Date</b>
Cristóbal Riquelme de Arroniz	Regidor, fifth lord of Coy, sixth lord of Santo Ángel	Murcia	1619–20
Diego Riquelme Dávalos	Regidor, first lord of Santo Ángel	Murcia	1443–80
Pedro Riquelme	Regidor, Procurador de Cortes, second lord of Santo Ángel	Murcia	1494, 1518
Cristóbal Riquelme	Regidor, third lord of Santo Ángel	Murcia	1541–6
Juan Riquelme Arroniz	Regidor	Murcia	first half 16th c
Cristóbal Riquelme Arroniz	Regidor	Murcia	first half 16th c
Alonso Riquelme	Regidor	Murcia	1544–51
Pedro Riquelme de Arroniz	Regidor	Murcia	1546–78
Nofre Riquelme	Regidor, fourth lord of Santo Ángel, Capitán de costa	Murcia	1543, 1562
Francisco Riquelme	Regidor, Capitán de lanzas	Murcia	1518–22
Luis Riquelme	Regidor, fifth lord of Santo Ángel	Murcia	1573–84, 1584–6, 1586–1607
Antonio Riquelme	Regidor	Murcia	1569–87
Bernardino Riquelme	Regidor	Murcia	1572–80

**Table 1.3** Public office positions held by the Riquelme family, thirteenth to sixteenth centuries<sup>123</sup> (*Continued*)

Name	Position	Place	Date
Diego Riquelme Pagán	Regidor	Murcia	1587, 1592
Pedro Guil Riquelme	Regidor	Murcia	1570–3
Miguel Valcárcel Riquelme	Regidor	Murcia	1589–1610
Macías Coque Riquelme	Regidor	Murcia	1551–79

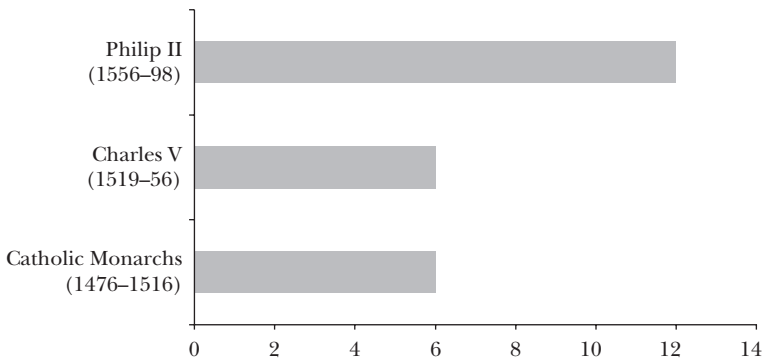

**Graph 1.3** Riquelme family members as *regidores*<sup>124</sup>



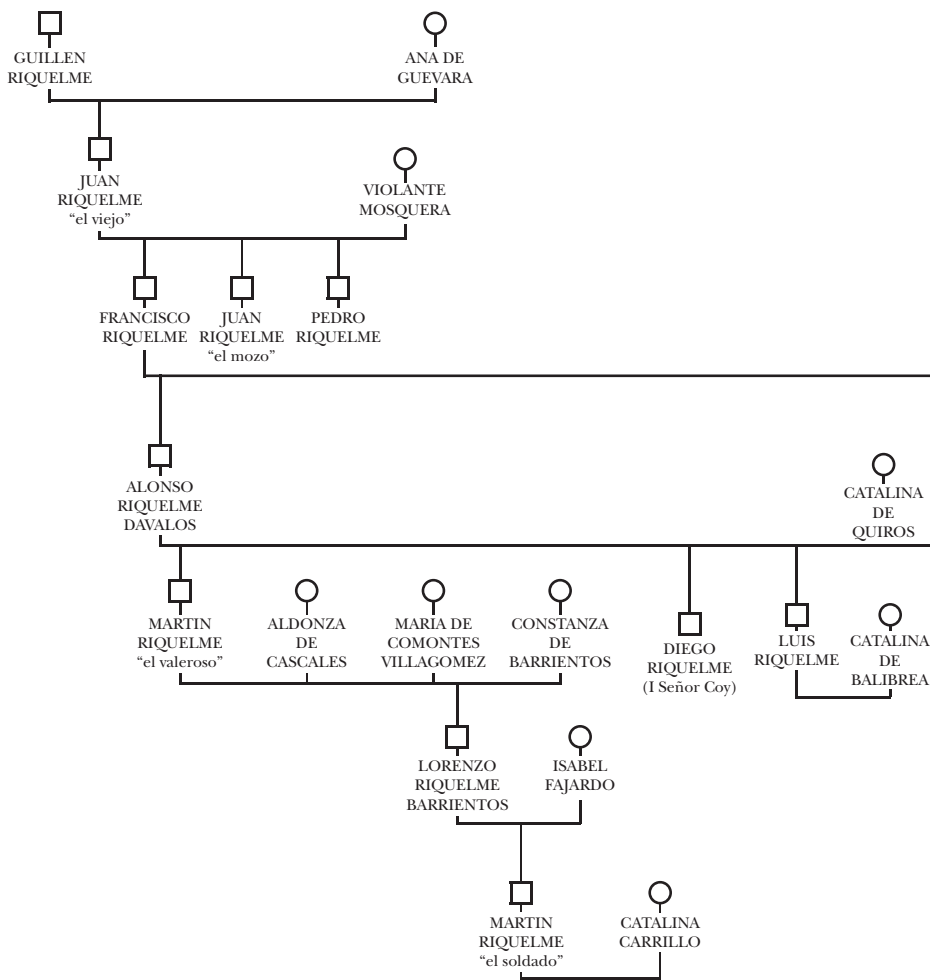

**Figure 1.1** Genealogy of the Riquelme Lineage (1264–1598)

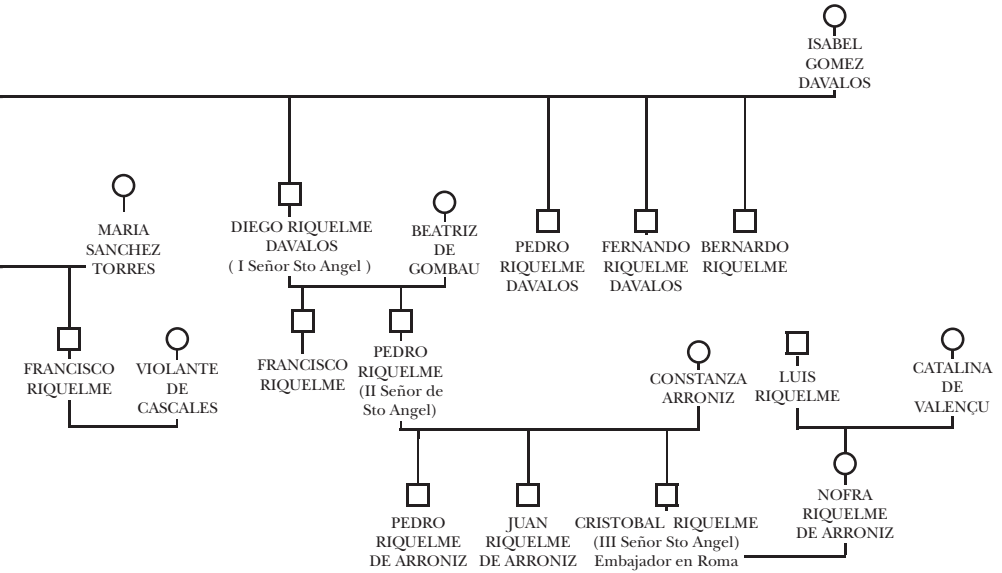

# Honour and Purity of Blood

---

## 2.1. Mixed Marriages between Christians and Jews: Struggles for Land Property and Sociopolitical Power (1550–1725)

The *comunero* revolt (1520) was a key moment in reviving and igniting the disputes and rivalries among different Murcian factions.<sup>1</sup> There was a clear continuity of the late medieval quarrels well into the early modern period, and these gained even more virulence during the sixteenth century in the context of the European Counter-Reformation.<sup>2</sup> The Hispanic monarchy was among the leading European Catholic monarchies creating all sorts of mechanisms to defend themselves and preserve the ‘true Catholic faith’ against the Protestant reform movement.<sup>3</sup> The mechanisms adopted in Spain were unique in comparison to other regions in Europe.<sup>4</sup>

The 1547 *estatutos de limpieza de sangre* (purity of blood statutes) implemented by Toledo’s cardinal-archbishop Martínez Silíceo were one example of what these mechanisms looked like. These statutes, which were clearly directed at those aiming for a position in the *concejo* (peasant community) to bear an *hábito militar* (military uniform), or to have a position in the Church, demonstrated the emergence of a new social archetype. Ultimately, it was a redefinition of the noble estate.<sup>5</sup> At this point, to have noble origins was no longer enough: another fundamental requirement was to be pure of blood. And purity of blood meant being completely free of Jewish, Muslim or Protestant ancestry. This really became the identifying element of purity among the Castilian lineages. The purity of blood statutes were unique and exclusive to the Iberian peninsula in the European context, and the elite in Europe firmly and clearly defended their ‘racial’ purity.<sup>6</sup>

In the Hispanic kingdoms, the *cristianos viejos* (old Christians) now competed with the *cristianos nuevos* (new Christians) – those newly converted who previously were of Jewish faith.<sup>7</sup> The reaffirmed and consolidated place of the old lineages that had participated in the reconquest (described in chapter one) reappeared with a new nuance in the sixteenth century. The concept of lineage, which emerged during the last decades of the medieval period, could then be described as bearer of all sorts of powerful and segregationist legal and theological provisions that had previously been advanced.<sup>8</sup>

In Mediterranean Europe, business, money and the purchase of nobility titles were the paths for newly wealthy families to upward mobility. The nobility, however, always met this advance with great resentment. This is why, as the purity of blood statutes were adopted in Spain, medieval factions reappeared during the *comunero* revolt. Signs of this continuity were the never-ending disputes among rival families, where the accusations of *judaizar* (Judaising) and of having a Jewish past translated into the idea of *deuda de sangre* (debt of blood), and the social sin<sup>9</sup> of those who had condemned Jesus Christ would be a key weapon used in campaigns and purges against opposing factions and individuals.<sup>10</sup> The conflict between nobility factions in southern Spain, in the kingdom of Murcia was fierce in the 1560s – the disputes of the Soto with the Riquelme lineages were good examples of such rivalry.<sup>11</sup> Members of these lineages, and especially those who fervently used the claim of purity of blood, could not have found a better tool to vilify, slander and attack the honour of an opponent than the Martínez Silíceo statutes. The number of cases submitted to the *Santo Oficio* (Holy Office), especially of Judaising, grew exponentially at the time.<sup>12</sup> Families coming from powerful groups of society instrumentalised the Inquisition with the sole aim of defeating adversaries.

The building and manipulation of genealogies with the goal of hiding any pinch of a Jewish past was the main objective for newly noble families. Members of these families had also acquired or purchased public office positions that the Castilian crown was freely handing out at the time.<sup>13</sup> A fundamental feature that defined the baroque man in Spain, and one that emerges at the end of the Renaissance as ‘immaterial capital’, was the protection of honour.<sup>14</sup> In the words of José Antonio Maravall, ‘honour is the award for doing what one is socially obliged to do.’<sup>15</sup> To damage

and challenge his honour defamed a noble's social esteem, and the only way to reclaim his honour was by eliminating the person who had insulted it in the first place. Lope de Vega's *Los Comendadores de Córdoba* rightly explained it – honour is a social tool that one cannot get but that is provided by others.<sup>16</sup>

Competition for honour was tough. In the context of constant noble disputes, whoever bore more honours had more right to power. This explains the arduous and long time that it took to obtain honours in Spain in the early modern period, such as wearing a military uniform from an order (Alcántara, Calatrava, San Juan, Santiago or Montesa), having a role in leading a peasant or a clerical community, becoming a member of the Inquisition, belonging to a noble *cofradía* (brotherhood), or the highly regarded appointments in court or owning a noble title.

Other arrangements that contributed to building up prestige for lineages were redacting records of nobility, building chapels emblazoning the façades of palaces or seigniorial houses.<sup>17</sup> These engagements helped demonstrate that the family's past was full of honour and social reputation. All of this 'material culture' had a clear goal – to praise the lineage's past and show that the group had participated in the Christian crusade during the reconquest against Muslims.<sup>18</sup> The claim was a pretentious and shallow creation of their own past.

### **2.1.1. Revival of Old Factions and the Mediation of the Inquisition: An Old Conflict, Riquelmes versus Sotos, Fifteenth to Sixteenth Centuries**

With the goal in mind of being close to the *adelantado*, the figure with the most political power in southern Castile and the kingdom of Murcia, both the Soto and the Riquelme groups knew they needed to be immersed in the Fajardo clientele. The personal mechanisms that defined feudal society were the modern version of the patron–client power relationships of the Renaissance.<sup>19</sup> The relationship between patron and client could be consanguinity-based or not – loyalty, solidarity, protection, and mutual aid were other types of linkages that bonded individuals and groups. The disputes among different factions in the kingdom of Murcia had their origins in the conflict between Alonso Fajardo '*el bravo*', whom the Soto group supported, and the *adelantado* Pedro Fajardo, with whom the Riquelme family allied.

Members of the Soto group were mostly in leading positions of *encomiendas santiaguistas* such as Caravaca or Moratalla – Juan Martínez de Soto led, as *comendador*, the *encomienda* de Caravaca.<sup>20</sup> Since they were not so prominent in military positions as armed knights and those defending the crown at the border, the Soto group could not be at the level of the Riquelme during the reconquest period.<sup>21</sup> As opposed to gaining prestige by participating in military campaigns, the Soto group achieved social promotion through marriage alliances with the members of the main family line of the Fajardo lineage. The bond between the Soto and the Fajardo lineages had been marriage-driven since early on – Juan Martínez de Soto married the daughter of the *adelantado* Alonso Yáñez Fajardo, Beatriz de Soto, in the first third of the fifteenth century.

The Riquelme political strategies were directed in two directions, the *adelantado* and the crown, establishing allegiances and services with both institutions and positioning the lineage at a more prestigious level. This was a period of prosperity for the Riquelme, and their success progressively ousted the Soto group, resulting in the social stagnation of the lineage of the latter. After the clashes between the allies of Alonso Fajardo ‘*el bravo*’, who were eventually defeated, and those that supported the *adelantado*, a dichotomy of victors and vanquished was clear.<sup>22</sup> Suspicions, grievances and jealousies were now at the forefront of the conflict between the two factions.

The factions that triumphed wanted to advance and crush the adversary for ever, and those who ended up as second-level individuals would do anything to raise their position. This was common in the warrior ideology of a European frontier and continuously warring territory like the southern Castilian kingdom of Murcia at the time.<sup>23</sup> Late medieval factions and their constant clientele disputes for power and control lasted through the early modern period as well, and even intensified during the second half of the sixteenth century.<sup>24</sup> The special geopolitical location of Murcia – as with other cities located in the Mediterranean area – aggravated these disputes and armed conflicts even more.<sup>25</sup> Michèle Benaiteau and Gérard Delille have studied these conflicts and the emergence of factions in France and Italy.<sup>26</sup> In the Italian case, solidarity, fidelity and kinship were at the core of the connections between factions. Different factions were supported by parishes and brotherhoods,

and they also had family ties bonding one faction to another. However, when disputes and rivalries arose, generally as a result of holding political positions which entailed more authority, the conflicts and battles were 'all against all'. When disputes emerged within a family, and even among different factions or families, everyone ended up being involved in a sort of global amalgam of struggle and conflict – '*io contro mio fratello, io e mio fratello contro mio cugino, io, mio fratello e mio cugino contro il mondo!*'<sup>27</sup>

The Italian *faide* was a system of factions and clientele similar to what existed in Castile. It was an institution: a social organisational reference of behaviour, conduct and responsibility norms in regard to the adversary. It delimited the groups and defined social relationships, and it became the system to resolve disputes.<sup>28</sup>

Throughout most of the sixteenth century, rivalries and conflicts became more aggressive among the lineages in the kingdom of Murcia.<sup>29</sup> Though there were some quieter periods throughout the century in the Crown of Castile, the first ten years of the 1500s, the years following the *comunero* revolt (1520–4)<sup>30</sup> and the decade of the 1560s were especially violent, and heresy accusations resurged as the most important weapon to slander the adversary. Between these periods, the different factions contained their battles, and although they were generally peaceful years, any minor dispute could revive the conflict. In addition, as factions used everything to hand to gain and control political power, the social context was extremely unstable.<sup>31</sup>

Memorials were created in the midst of these conflicts all over the Iberian kingdoms, and as they show in the case of Murcia, there were violent disputes between the two factions in the beginning of the sixteenth century. In one of these confrontations, 'the [direct] niece of Matias Coque Riquelme amputated the nose of an honest and well-connected Murcian *hijodalgo*.'<sup>32</sup> Disturbances were common between important families in the city of Murcia, 'the mortal passion between old and known factions, the Riquelme and the Soto groups; the faction leader of the Riquelme was Mathias Coque Riquelme, grandfather of Mathias Fontes.'<sup>33</sup>

*Regidores* Martín Riquelme (also leader of the faction against the Soto group) and Pedro Soto were dismissed from the *concejo* or peasant community meeting after they exchanged a battery of insults.<sup>34</sup> On Monday 17 August 1506, the *regidor* Pedro de Soto and his brother Francisco were attacked and injured by members of the

Riquelme family.<sup>35</sup> These purges, at times extremely violent and tense among both lineages, went on for most of the sixteenth century.

When the Riquelme reached the top of the kingdom's power pyramid through their sociopolitical strategies, combined with the Fajardo lineage, the *comunero* revolt was the perfect excuse for the Soto group to resuscitate their battle against the Riquelme lineage and place themselves with the party that opposed the marquis of Vélez.<sup>36</sup> After the *comunero* revolt, the wedge between the factions continued to grow in southern Castile. During the 1540s, both parties continued to disagree as to what role the marquis of Vélez, who was separating himself from the king, would have in the city government.<sup>37</sup> The Soto group rejected the right of the marquis to govern the city, and the Riquelme defended it.<sup>38</sup>

John B. Owens explains that the violence and tensions that Murcia experienced as a frontier region were inherited from the late medieval period, and that this legacy also accounted for the ferocity and intense violence of the conflict between factions during the early modern period. And, as in the Italian kingdoms, the purges can be defined as intrafamilial disputes, all factions being connected through family ties.<sup>39</sup>

### 2.1.2. The Role of 'Blood' in the Conflicts: The Adoption of the Martínez Silíceo Statutes

After the preaching of the Franciscan friar Vicente Ferrer and a decree of the late fifteenth century by the Catholic monarchs mandating expulsion of anyone who refused to convert to Catholicism, there was a massive wave of conversions to the Catholic faith.<sup>40</sup> As a result, the *crístianos viejos* (old Christians), and especially the nobility in this group, suddenly were bearers of key, positive cultural and ethnic elements that distinguished them from those of Jewish descent who had just converted to Catholicism, the *crístianos nuevos*.

Such differentiating elements became fundamental in Spain in the sixteenth century, and even more so as Protestant reform advanced through Europe, making Catholic monarchs across the continent adopt their own defensive mechanisms against this 'danger'. *Crístianos viejos* knew very well that they needed to redact rules and statutes that defined purity of blood so as to distinguish them from *crístianos nuevos*.



Awareness of *sangre divina* (or divine blood), of having ancestors going back to the tribes of Israel, made converted Jews feel privileged within the social body of Christians. Gutiérrez Nieto says that converts were the yeast that boosted the development of the Christian bourgeoisie.<sup>41</sup> Hence the focus on the urban character of the Jewish community. Julio Caro Baroja emphasises that the *converso* is generally part of the bourgeoisie, both because he lives in the *burgo* or city, and also because he is part of an emerging middle class that belongs to the middle levels of the business and financial worlds.<sup>42</sup> The Jewish conversion gave the *cristianos nuevos* access to professions formerly prohibited, such as positions in the administration (*secretarías*, secretaries; *escribanías*, notary offices), in the *cabildo catedralicio* or council of the cathedral (*canonjías*, *deanatos*) or in the civic council (*regidurías*).

With their new social status, Jewish converts to Christianity began to access positions that were previously denied to them because of their religion – conversions had an immediate impact in the processes of social mobility within the group of *cristianos nuevos*. This social sector, wealthy through business and capital accumulation, now attempted to be level and assimilated with the old nobility. They followed a ‘reconversion strategy’ by trying to be included among the ruling elite.<sup>43</sup>

Juan Hernández Franco has thoroughly studied the social trajectories of the *conversos* in the Murcian elite of southern Castile. He highlights the ‘steepening’ social trajectory that occurred in the heart of the Santesteva-Lara family.<sup>44</sup> With *judeoconverso* origins, the family, during the first half of the sixteenth century, rose up to the level of the old urban oligarchy. This allowed them into relevant ecclesiastical and civil positions such as *canonjías* or *regidurías*, and their trajectory is critical to understanding the end of the conflict between the Riquelme and Soto families.

Historians have documented this upward mobility of the *cristianos nuevos*, and their assimilation in the nobility brought deep resentment among the old urban oligarchy of Castilian communities.<sup>45</sup> These tensions were at the centre of the revived conflicts and disputes among the Murcian factions. The marriage of Beatriz de Soto y Diego de Lara became the perfect excuse that the Riquelme used to vilify the honour of the Soto lineage, which was now stained by the de Lara’s Jewish ancestry. The Riquelme adopted a number of discrediting strategies – namely the infamous charges of being a

*converso judeizante* – when the crown created positions for them in 1543 and 1544.<sup>46</sup> The opening of positions permitted *cristianos nuevos* access to *regidurías*, and they then sided with the Soto group. Their rivals would fight so that this favouritism did not spread through Murcia's public life.

This is why the establishment created ways to maintain their traditional structure, as evidenced by Juan Martínez Silíceo, soon to be cardinal-archbishop, when he wrote the purity of blood statutes while he was the bishop of Murcia (1541–6). Purity of blood became in Spain the differentiating trait.<sup>47</sup> Martínez Silíceo referenced the New Testament, e.g. Matthew (23:4) and Paul, who differentiated Jews from Gentiles – ones who embraced the true faith while the former were hidden in 'a world of darkness'.<sup>48</sup> The interpretation of biblical texts was often wrong and malicious enough to justify ethnic segregation of those who had converted.<sup>49</sup> The Dominican Agustín Salucio later and rightly stated in a popular publication<sup>50</sup> that both factions hid behind the purity of blood statutes. Slanders accusing the opposing lineage, no matter how pure that lineage was, darkened and vilified for ever.

Such procedure was the common, most destructive way to settle conflicts among 'factions and partialities' in each place. Many enriched themselves only by cleaning or staining lineages. The Dominican friar Domingo de Baltanás argued in *Apologías sobre ciertas materias morales en que hay opinión*, which appeared in 1556 in Seville, that the purity of blood statutes were the seeds of the 'discord of the lineages'.<sup>51</sup>

The nobility used the purity of blood statutes to contain the new social sector that had become wealthy, was seeking to gain positions of power and become part of the ruling elite.<sup>52</sup> The role of blood was central to this social inclusion in an already stratified and caste-based *ancien régime* society.<sup>53</sup> Bartolomé Bennassar has documented in detail these clashes between factions. The resentment and envy that emerged towards families that were advancing on the social ladder were notorious. In the case of Andalucía, Bennassar showed, '*la plupart des affrontements se produisent entre une famille prééminente, parfois reconnue comme noble avant les autres, et une famille montante, dont la première entend freiner l'ascension.*'<sup>54</sup>

As mentioned earlier, the marriage of Beatriz de Soto and Diego de Lara was the turning point for the disputes between the Soto

and Riquelme factions to become violent. The factions used the *Tribunal de Fe* (Court of Faith) to launch the crossfire of allegations about *judaizar* that had the sole purpose of defeating the adversary. Jaime Contreras closely traces the battles where the Murcian elite were ascribed to one or the other faction.<sup>55</sup> Their goal was to find out why Francisco Riquelme had been made *clérigo de menores*, and this is what revived the hatred between the family factions.<sup>56</sup>

Attacks between families of different lineages intensified with the establishment of the purity of blood statutes in the sixteenth century.<sup>57</sup> Around 1560, the noble *cristiano viejo* was the social archetype. To assault his personal and family honour was the key to vilifying the adversary. Many of the cases before the *Chancillería* (regional court) in Granada were attempts to prove noble origins and to erase any drop of spurious blood. One such case involved the *regidor* Francisco Guil, connected to the Riquelme lineage, who had accused Doña Inés Coque and her children of having blood stained by Jewish ancestry.<sup>58</sup> This is evidence of the intrafamilial conflicts at the heart of the disputes between factions – the Guil, Coque and Riquelme families all belonged to the same family group and were closely related.

Accusations of Jewishness between factions also emerged in the disputes to control municipal power in the Iberian kingdoms. During the second half of the sixteenth century, when the coffers of the Hispanic monarchy were depleted, the selling of positions of public office increased. Taking advantage of the situation, the emergent bourgeoisies used these appointments to move upwards and became equal to the nobility. In the kingdom of Murcia, this process of upward mobility aggravated the ongoing frictions. An example of the tension was Macías Coque Riquelme's attempts to prevent the entry of Luis de Ceballos, a wealthy merchant and trader who belonged to the Soto lineage, into the *regidurías* of the *concejo*. The commentary suggested that money had made a convict into *regidor*.<sup>59</sup>

Older families of Murcia like the Pagan, Riquelme, Guil and Coque railed against purchased appointments in *regidurías* and other positions in the *cabildo catedralicio*. For them, money was not the only problem; the legitimacy of these appointments was also doubted because the holders were perceived as individuals with stained blood. On the opposite side, those closer to the Soto lineage such as the Lara, Valibrera, Ceballos and Bustamante had

acquired trades and positions in office by an important process of upward mobility. During this time of inquisitorial furor in Castile, they remained silent and fearful, just hoping that the very active threats, which were the result of the passing of the statutes of the purity of blood, would gradually dissipate.

It is worth noting that the families from each faction or *linaje-patrón* line were also connected with each other. The social groups that were disputing access to power were therefore actually related to each other, which brought up a dialectic situation and deep contradictions deeply embedded in the Spanish baroque world. It even seemed as if they preceded what happened in the dawn of the Renaissance.<sup>60</sup> The purges of everyone against everyone turned into fierce conflicts within lineages, and the mechanisms they designed to safeguard their illustrious noble heritage ended up rebounding on them.

The Valibrera family was one of the families from the opposite faction with whom the Riquelme had family ties.<sup>61</sup> At the end of the fifteenth century, Luis Riquelme married Catalina de Valibrera Ceballos, and a century later Inés Riquelme was Juan de Ceballos y Bustamante's wife.<sup>62</sup> Around the same time in the mid-sixteenth century, Diego Riquelme de Comontes (third lord of Coy) married Isabel de Bustamante; and Pedro Riquelme (second lord of Santo Ángel) married Constanza de Arroniz in the late fifteenth century.<sup>63</sup> The *Santo Oficio* condemned both the Bustamante and Arroniz surnames in the sixteenth century – Catalina de Arroniz was *relajada* (taken to the civil authorities) in Murcia in 1560, Isabel de Arroniz was *reconciliada* in 1554, and Diego Arroniz was disqualified from public office appointments and fined 4,000 *maravedíes*.<sup>64</sup> The Bernal and the Avilés also had strong family ties with the Riquelme and were equally convicted by the inquisitorial authorities.<sup>65</sup> Ana de Avilés Bernal, the daughter of Constanza Bernal and Diego Riquelme de Avilés, and spouse of Cristóbal Fontes de Albornoz, was also processed and accused as *judaizante* during the acts of faith that were carried out in the 1550s and 1560s.<sup>66</sup>

No one seemed to be free from the danger of the flames of the Spanish Inquisition, not even renowned families like Riquelme. The mechanisms that the older nobility had put in place, like those derived from the tough *estatutos de limpieza de sangre*, looked as if they were turning against them. In pursuing ties with noble

families, the Riquelme had, by the beginning of the sixteenth century, already acquired enormous socioeconomic potential with the objective of uniting great family properties and attaching them to the lineage through the creation of *mayorazgos*.<sup>67</sup>

In order to erase the stain from the past and to safeguard their name as an honourable family, with all the political and economic strength that an important lineage entailed, the solution was to block any adversary's access to power. The Riquelme lineage hoarded all the power by seriously slandering the opposing family as a lineage with a Jewish past, and also making use of their wealth. To establish itself in the community, in the *res publica*, as a clean, illustrious and powerful family, the Riquelme's ultimate goal was to eliminate, defeat and defame the opposite faction. The main objective for the Riquelme group was to prevent the Soto family from having any control of power by cutting all access to positions in public office. To do so, to remove the adversary from the *concejo*, the Riquelme used an efficient tool, the *Santo Oficio*.

The focus of the disputes was to achieve the greatest number of pockets of power.<sup>68</sup> The intrafamilial conflicts were even greater because of it, and especially during the power vacuum that the marquis of Vélez left when he was attending to foreign affairs issues and wanted to be closer to the Castilian court. The *jurado* Francisco Guil, close to the Riquelme lineage, suggested to the *concejo* that the *cabildo* updated their ordinances about the *limpieza de sangre* of the officials, just as the *cabildo* of the cathedral had done in 1544.<sup>69</sup> Guil argued that it was 'because the city has an ordinance that the officials are clean and *cristianos viejos*, that ordinance has to be put in place'.<sup>70</sup>

The Riquelme *linaje-patrón* was slowly establishing its power over the Soto's. The 1560s was the most violent and bloody of decades, all due to the strong tensions between the lineages, which were worse than ever. The misrepresentations, false accusations and the clashes in the public space led to overcrowded inquisitorial jails and to extremely intense *Santo Oficio* pyres.<sup>71</sup>

In 1561, *regidor* Macías Coque Riquelme called for royal justice to end the clashes, straight after two *jurados* close to the Riquelme group had been assassinated.<sup>72</sup> The violence in the streets of Murcia continued between the two factions, and around the same time three members of the Riquelme lineage were detained: Gerónimo Riquelme, Pedro Riquelme and Cristóbal Bustamante.

In 1562 the *Alto Tribunal* gave orders to cut their hands off, and this provoked the rage of the Riquelme group against *inquisidor* Manrique.

From this moment onward the Riquelme regrouped against their enemies through the *Santo Oficio*, and inquisitor Manrique usually favoured their claims. Such an alliance meant the definitive collapse of the Soto group. When the Jewish past of the Lara family was proved and confirmed, the inquisitorial tribunal ordered their bones to be exhumed and burnt in public.<sup>73</sup> The public show meant the permanent condemnation of the Lara name, and as a result also that of the Soto family. Between 1560 and 1564 renowned members of the Lara family blazed in the flames of the *Santo Oficio*, and thus the Soto's aims to be part of the ruling elite never came to fruition.<sup>74</sup>

Members of the Riquelme *linaje-patrón* such as Francisco Guil, Rodrigo Pagán, Pedro Riquelme and Macías Coque met with the *visitador del Santo Oficio* to establish a new relation with the tribunal and the great families of Murcia.<sup>75</sup> The *cédula* that Philip II signed in 1567 declaring a royal pardon ended this conflict.<sup>76</sup> Riquelme members that had been convicted as a result of the disputes and public accusations were pardoned and reincorporated into public life. The pact for reconstruction that the Murcian oligarchy had elaborated was then ratified. Also, clear evidence of the victory of Riquelme over Soto was the appointment of Riquelme members in *familiaturas* of the *Santo Oficio*, which the Riquelme efficiently used to defeat the opposite faction. Macías Coque Riquelme was appointed *familiar* of the *Santo Oficio* on 30 March 1570, and around the same time Nofre Riquelme was also given the position.<sup>77</sup> The *Tribunal de la Fe* joined forces with the Murcian oligarchy and together they created an extremely strong social power structure.

The Riquelme were on top, with no competition, of the political power ladder after the defeat of their long-time rival, the Soto lineage. During the reign of Philip II, they gathered even more *regidurías* – nine in total, more than in previous years (see chapter one, graph 1.3). Their control was deep, and it continued to increase. In the public sphere and the community, the noble Riquelme were now seen as the illustrious lineage with old, clean blood running through their veins against the defeated faction, the Soto lineage, that bore impure blood.

### 2.1.3. Accusations of being Jewish within Elite Families

#### 2.1.3.1. Links to the Robles-Muñoz Family

After the conflict between factions ceased in the last third of the sixteenth century, Murcian society seemed to live in a state of calm. The fury of the *Santo Oficio* against any sign of heresy, which had resulted in massive *autos de fe*, began to decrease as it was clear that the inquisitorial system in place was in fact damaging the pillars if not the actual buildings of Castilian society.<sup>78</sup> No social estate, and not even the ruling elite, was free from heresy accusations. The Spanish monarchy and some members of the elite, and also with the help of the Papacy in Rome, established a set of measures that ended the cruel conflict between factions. However, the end of the clashes was still far from reality.

Still, there was a time of calm from the 1570s and 1580s, and such relaxation allowed the *hidalguización* of a large number of wealthy families.<sup>79</sup> Some were dedicated to trade and business, and others focused on administrative and bureaucratic functions, which were originally attached to the Jewish community, and thus it was socially despised to hold these positions.<sup>80</sup>

A large number of families entered the ranks of the local elite and advanced socially by taking advantage of these empty positions, as they had done in the 1540s when the Castilian crown sold positions to refill their coffers. Such was the case of the Muñoz and Robles families, ascribed to the local *caravaqueña* bourgeoisie, who became wealthy doing business and trading, and later were appointed scribes, lawyers or secretaries. Juan Robles, from Caravaca, was the *escribano mayor* of Caravaca in the mid-sixteenth century.<sup>81</sup> The Muñoz family remained in Murcian territory through landownership all the way to the border with the kingdom of Granada. Don Juan Antonio Muñoz y Díaz, for example, settled in the city of Baza and held the position of lawyer in the *Reales Consejos*.<sup>82</sup> They followed a process of upward mobility by entering the nobility and acquiring status and prestige at a high sociopolitical and economic level. They held important appointments in the *concejo*. For example, Francisco Musso Muñoz was the *alférez* of Caravaca and Diego Robles, brother of Juan Robles, took one *regiduría* in the *concejo*.<sup>83</sup>

In order to continue increasing their status in the local oligarchy, the Muñoz family allied with the Riquelme through marriage. María Riquelme y Arroniz married Juan Pedro Muñoz de Robles

in 1621.<sup>84</sup> Both families joined their properties and thus both lineages became linked through the Robles's *mayorazgo*, founded on 15 November 1557 by Juan Robles in Caravaca, and the Muñoz's *mayorazgo* that Pedro Muñoz established on 7 March 1577 in the same location.<sup>85</sup> Through the union both families advanced, and also the Riquelme patrimony was consolidated, enlarged and made more permanent. This is the reason why the Riquelme covered the Jewish past of both of these families – Pedro Muñoz received the legitimation letter in Madrid on 28 March 1568.<sup>86</sup> The letter mentioned, however, the uncertain past of Pedro Muñoz and also the children he had had in an illegitimate marriage with Catalina Musso (single woman, not forced to be married). For this reason, he begged His Majesty to rehabilitate him so that he could receive his inheritance, and the king granted his plea. Still, the Spanish monarchy was going through multiple phases of a scarcity of money due to sequential bankruptcies, and it did not care to whom it gave royal *mercedes* (graces and grants).<sup>87</sup>

To hide the past, the property donation letter required the daughter of Pedro Muñoz, Doña Isabel, to 'marry a *hijodalgo* (noble) and of pure blood' since she was the offspring of an invalid marriage. There was, therefore, a quiet integration of these families cleaned of a Jewish past.<sup>88</sup> However, this was only possible when a family had acquired enough social and cultural capital and also when there was a will to erase questionable origins from public memory.<sup>89</sup>

The Castilian social establishment, as this section argues, came about through the institution of mixed marriages, which became a warranty for social integration.<sup>90</sup> A stained blood spread through the main pillar of the Riquelme lineage because of the union with such families, but on the other hand these families provided the Riquelme family the opportunity to enlarge their economic patrimony, which the tribunal of the *Santo Oficio* had reduced after the events in Murcia in the mid-sixteenth century. This process is also evidence of one of the greatest contradictions of Spanish baroque society. On one side, the nobility, through the *estatutos de limpieza de sangre*, was limiting the integration of the elite and the emerging social groups. On the other side, the traditional oligarchy, embedded in local power, was not isolated from the economic advance of the emergent groups, and they finally opted to join them.



As Marcel Mauss explains, this was a favour and gifting economy based on giving and receiving honours in exchange for socioeconomic compensation.<sup>91</sup> The emerging families provided the nobility with significant economic patrimony, which enlarged and consolidated the patrimony of the elite families. The elite provided the emerging families from the middle strata with social and honourable capital. In addition, by joining the old, illustrious lineages who had participated in the reconquest, the emerging families were able to hide or cover their possible Jewish past. The social benefit was mutual, a reciprocal relationship from which each group gained by receiving favours.

#### *2.1.3.2. Links to the Fontes-Paz Family*

At the end of the sixteenth century, during this period of relative tranquillity in the kingdom of Murcia, the local oligarchy regrouped. The narrowing of the ties between the Riquelme lineage and the Fontes can be understood in this context. The Fontes lineage were:

legitimate descendants, coming from the noble house of Fontanet that is located with the *señorío* of the town there that is close to the city of Marseille in the kingdom of France from where they came in the year 1150 to serve the kings so glorious with an enterprise of horses to assist the count of Barcelona Don Ramon Berenguer I and family and lord king James I to conquer the cities of Murcia and Origüela, in which recovery also Arnaldo de Fontes, grandson of the man mentioned, assisted . . . for the conquerors of the mentioned lord of Murcia there was a partition of lands and they became one of the settlers of the city of Origüela . . . The surname of Fontes also could be added to the coat of arms of the mentioned house, eight crosses of black blazes on a field of gold . . . since prince Recaredo, brother of the holy king Hermenegildo was married to Badda from the first nobility of the Goths, daughter of Fontes count of the Patrimonios . . . you are connecting with some great houses and with titles of those my kingdoms like the Vélez, count of Fuentes, marquis of Espinardo and others of the surname Miron Dueño from the noble house of Redoran, very old-established in the city of Origüela because mosen Pere de Fontes married señora Antonia Miron . . .<sup>92</sup>

There were other unions, like the one between Riquelme and Fontes, with similar backgrounds in the kingdom of Murcia. They

all flaunted their illustrious heritage that descended from the northern Spanish kingdoms' participation in the reconquest. After the battle, king Alfonso X partitioned land and other properties among the victors, like Fontes in Origüela, eventually weaving together most renowned family names.<sup>93</sup> The ultimate purpose of the unions was socially to close off the noble estate and make it as impermeable as possible to the emerging social intermediate strata.

Like many other families of the Murcian oligarchy, the Riquelme group was ascribed to the clientele of the Fajardo, under the umbrella of the marquis of Vélez. During the mid-sixteenth century, however, and after the *comunero* revolt, the marquis's rule slowly distanced itself from ongoing events and from the political life of the kingdom.<sup>94</sup> Pedro Fajardo, third marquis of Vélez, was increasingly engaged at the court and also with the Castilian crown's foreign policy. Still, the families from the *concejo* of Murcia were never completely isolated from the marquis, resulting in an alliance of the Murcian oligarchy based on the union of the most renowned family names. The first example of this process in the case of the Riquelme and Fontes was the late sixteenth-century union between Isabel Pagán Riquelme and Nofre Fontes de Albornoz y Avilés.<sup>95</sup> From then on, and until the first third of the nineteenth century, the destinies of both names were closely related to the alliances and strategies that they forged based on marriage alliances.

In this context, the Riquelme strengthened their position in the oligarchy and established contacts and alliances with other illustrious family names like Bienvenegud, Carrillo, Melgarejo, Puxmarín and Verastegui.<sup>96</sup> These names were at the heart of the region's social network of families – all of them registered an important social trajectory, not only at the local level, but they also allowed the Riquelme lineage to be in contact with families with a long-standing social record and influence at court, and also with powerful families who held important titles of nobility. The surname Fontes also rose significantly during the seventeenth century thanks to the continuous donation and selling of *mercedes* and graces by the Habsburgs. For example, on 23 March 1692, Macías Fontes Carrillo y Albornoz received the title of marquis of Torre Pacheco. The cost of the title was 572,500 *maravedíes*, and it nullified the title of *vizconde* of Alguazas that Macías had once

held.<sup>97</sup> To serve the prince as a loyal subject and fine vassal was honourable and well seen publicly among noble families. In *Empresas Políticas* Diego Saavedra Fajardo explains that ‘the role of the king is to give and measure his landownership not looking for his advantage, but the greater good, which is the real outcome of the riches. To some we give because they are good, and to others we give so that they are not bad’; and to those that served the king by honouring him, ‘since he is the prince similar to God, who always gives everyone abundantly’.<sup>98</sup>

As the Fontes family received a noble title, endowing the lineage with great status and social prestige, the Riquelme benefited indirectly since they were loosely linked to the Fontes lineage through family ties. The Fontes lineage remained at court and was in constant contact with families from other territories who were also advancing their careers at court. They wanted to thrive and obtain privileges from the monarch.<sup>99</sup> A prime case was that of Baltasar Fontes Melgarejo, second marquis of Torre Pacheco, son of Macías Fontes Carrillo. He stayed at court as *caballerizo* of Charles II and later married Nicolasa de Paz y Castilla, born in the *villa* of Frejenal de la Sierra, on 8 October 1702 in the parish of San Sebastián in the *villa* of Madrid.<sup>100</sup>

The Fontes and Paz were two important families with high socio-political and economic power. Of different origins but similar social trajectory, they came together with the happy idea that the union was going to increase their social prestige and consolidate their honour as powerful, untouchable families. However, the request by Ventura Fontes Paz (son of Baltasar Fontes and Nicolasa Paz) to exercise a *familiatura* of the *Santo Oficio* uncovered a fifteenth-century inquisitorial case against the Jewish ancestry of the Paz family, which had provoked clashes and disputes between factions in the region of Extremadura.<sup>101</sup> The honour of the Fontes family was put under pressure as well since they had joined forces with the Paz and the Riquelme families – the brother of Ventura Fontes, Antonio Fontes Paz (third marquis of Torre Pacheco) was married to Francisca Riquelme y Buendía, herself a member of the main family of the Riquelme lineage.<sup>102</sup>

These events were revivals of the cruel disputes that had occurred between factions during the sixteenth century in the Iberian kingdoms. The honour of illustrious families with a remarkable past like Fontes and Riquelme was stained and

vilified when new clashes resurfaced in the nobility. The connections between some family groups and subgroups become visible in this process even when they were located in different places. Their destination, or common goal, was to be received at court. The union of the three (Fontes, Riquelme and Paz) was like a pyramid vertex with one edge expanding to Murcia and the other to Extremadura.

The *criptojudío* communities of Extremadura, from where many *judeizantes* groups appeared at the end of the fifteenth and during the sixteenth century, were located in many towns in regions like Frejenal de la Sierra, Mérida, Zafra, Alburquerque, Babajoz, Llerena and Jerez de los Caballeros.<sup>103</sup> The *Santo Oficio* strongly targeted and repressed these communities – which followed Mosaic law – from Llerena, the Inquisition's headquarters in Extremadura.

Many Jewish subjects opted for conversion after the measures that the Catholic monarchy implemented in 1492. Those who preferred to continue embracing the Jewish faith, however, had to go into exile to Portugal.<sup>104</sup> The closeness between Extremadura and the Portuguese border allowed a covert conversion of the Jewish communities as well – most of the *conversos* continued to practise Mosaic law, but to hide their Jewish past they simply 'mixed with *cristianos viejos*', and they also 'put forward declarations that proved they were *cristianos viejos*'.<sup>105</sup>

By the mid-sixteenth century, with the *estatutos de limpieza de sangre* in place and seeing the inquisitorial rage that had emerged in Murcia, it was clear that the lineages of 'old Christian blood' were not going to allow 'individuals with stained blood' (of Jewish ancestry) to hold high-rank postings in the *concejo* and the ecclesiastical *cabildo*. The disputes between factions in Extremadura were intense.<sup>106</sup> The passionate factional clashing, that had originated in the late medieval period, continued through the last decades of the sixteenth century, in the midst of the European and Spanish Counter-Reformation surge, when the accusations and calumnies of *judaizar* against individuals from the opposite faction were constantly made to dishonour them.

Nevertheless, conflict was not a 'continuum' feature of the famous lineages. There were some periods and in different places when and where clashes intensified. The conflicts among factions appeared and disappeared in the Crown of Castile in the seventeenth century, and were extreme in the beginning of the

eighteenth century. Behind this process was the discredit of the adversary for the final defeat. The accusations of *judeizar* were always present before the *Santo Oficio*, however, to dishonour the opposite faction and exalt one's lineage in front of the inquisitorial tribunal.

The causes and the forces that pushed individuals from the factions to vilify opponents are better understood as a recurrence of old conflicts. The origins of this particular process are in 1722 when Ventura Fontes Paz applied to hold a *familiatura* in the *Santo Oficio*. After the application, there was a space/time breakdown – spacewise, there was a jump from the kingdom of Murcia to Frejenal de la Sierra (Extremadura), and in terms of time, there was a turning from the eighteenth back to the fifteenth, sixteenth and seventeenth centuries. Even before the evaluation process for the *familiatura* began, and before the investigation of his proofs of purity of blood had started, lords Gonzalo and Juan Antonio de Bolaños Paz, both sons of the marriage between Gonzalo Sánchez de Bolaños Maraver and Isabel María Paz de la Barrera, warned about the case for his *familiatura* – their marriage had been celebrated in the parish of Santa Ana de Frejenal de la Sierra on 17 January 1638.<sup>107</sup>

Their warning to those in charge of Ventura's proofs in the *Santo Oficio* was that they had heard from a related family member, Nicolasa de Paz y Castilla and mother of Ventura, about the proofs, and that there 'were going to be people that would try to darken our reputation'. They also announced the names of the individuals who would appear in the process, and who would try to stain the name because of animosities and disputes that they had had in the past. The names were Ignacio Rodríguez Pastrana, ecclesiastical judge of Frejenal de la Sierra; Francisco Moreno; Andrés Rodríguez Chacón and his son Diego Chacón; Matías Aguilar (*presbítero*); Ignacio José Rodríguez (lieutenant-priest of the parish of Santa Catalina); and Feliciano Rodríguez Tinoco (*presbítero* of Frejenal) and related to Aguilar and Rodríguez.

Gonzalo and Juan Antonio Sánchez de Bolaños declared that they were sons from their father's first marriage with Isabel María de Paz and not from his second marriage with Antonia Santander y Liaño, celebrated on 3 January 1657 in the parish of Santa Ana in the *villa* of Frejenal. The second union was the cause of all the conflict, and they stated: 'we regret the second marriage for having

caused many enemies to us.' They claimed to be descendants of the Paces de Salamanca family, who had come to the *villa* of Frejenal almost three centuries before in the person of Luis Álvarez de Paz, lord of the house and *corrales* of Antón Paz, born in Salamanca, and the first to settle in Frejenal. They used an illustrious genealogy to leave no doubt about their purity of blood (see Table 2.1).

**Table 2.1** Positions of the Paz Family (1411–1600)<sup>108</sup>

<b>Titular name</b>	<b>Foundation of vínculos</b>	<b>Position</b>	<b>Hábito in military Order</b>	<b>Date of will</b>
Luis Álvarez		Counsel to the king		Salamanca, 1411 before Julián Palomeque
Sancho de Paz				Frejenal, 26 April 1536 before Rodrigo Tello
Antonio de Paz				Frejenal, 1560 before Rodrigo Tello
Alonso de Paz	<i>Patronato</i> in the Colegio de Monjas Nuestra Señora de la Paz			Frejenal, 25 October 1597 before Juan Pérez Calleja
Francisco de Paz				Frejenal, 1564 before Juan Tallejo de Tapia
Diego de Paz				Frejenal, 1592 before Francisco de León
Alonso de Paz			Knight of Santiago	

**Table 2.1** Positions of the Paz Family (1411–1600)<sup>108</sup> (Continued)

<b>Titular name</b>	<b>Foundation of vínculos</b>	<b>Position</b>	<b>Hábito in military Order</b>	<b>Date of will</b>
Alonso Antonio de Paz		<i>Procurador de Cortes</i> of Salamanca. Of the <i>Consejo de Hacienda</i>		
Francisco Alonso de Paz		<i>Capitán de caballos</i> . In Flanders: <i>maestre de campo</i> . <i>Paje</i> of His Majesty Philip IV. <i>Conductor de Embajadores</i>	Knight of Santiago	
Juan Tinoco		<i>Familiar Inquisición</i> of Llerena		
Álvaro de Castilla		Of the <i>Consejo de Cámara</i> of His Majesty		
Francisco Ossorio de Castilla		Of the <i>Consejo de Ordenes Militares</i>		
Francisco Alonso de Paz y Castilla		<i>Paje</i> of Charles II. <i>Capitán de caballos</i> in Flanders. Mayor for the <i>Estado Noble</i> of Frejenal		Died in 1695

**Table 2.2** Interrogation in the *villa* and court of Madrid<sup>109</sup>

Witness	Appointment, position, or title	Declaration
Don Lope Fernández de la Rioja	Knight of Santiago	Favourable
Don Carlos Gerónimo de Villa Padierna		Favourable
Don Gonzalo de Escalante	Knight, friar and bearer of the dignity of high <i>sacristan</i> of Alcántara in the <i>villa</i> of Brozas (Extremadura). <i>Presbítero</i> and confessor. Honourable Captain of His Majesty	Favourable
Don Simón José de Olivares	Lawyer of the <i>Reales Consejos</i> . Consultor at the Order of San Juan	Favourable
Don Juan de Ucedo	From His Majesty's <i>Consejo</i> and from the <i>Junta de Aposento</i>	Favourable
Don Juan Sarmiento Valladares		Favourable
Don Pedro del Castillo y Herrera	Lord of the House and place of Belmez	Favourable
Don Gregorio de Otanda	Secretary of the duke of Arcos	Favourable
Don Francisco Ponce de León	<i>Paje</i> of Charles II	Favourable
José Font		Favourable
Antonio Sánchez Mena	<i>Familiar</i> of the <i>Santo Oficio</i>	Favourable
Don Gabriel García Izquierdo	<i>Recaudador</i> of Rentas Reales	Favourable

To understand the trajectory of the family name Paz it is important to examine its relation to Francisco de Paz y Castilla, the maternal grandfather of Ventura Fontes Paz, who settled in the *villa* and court of Madrid and was *paje* of Charles II and the captain



of horse in Flanders. Being at court, Francisco de Paz became acquainted with other renowned courtiers with similar surnames and established close ties with highly prestigious families that were already orbiting around the monarch. He married Ana Polizena Espinosa y de Paz at the church of San Martín de Madrid in 1672, which constituted endogamy, since it was a union between distant cousins. Together, they settled in the houses of Lope de Rioja, knight of Santiago, that were close to court.

Based on the sources about the interrogation, the surname Paz had a solid reputation in the *villa* of Madrid. The father of Francisco de Paz y Castilla, Francisco de Paz, visited the Order of Santiago, was *conductor de Embajadores* and resided in the parish district of

**Table 2.3** Interrogation in the city of Murcia<sup>110</sup>

<b>Witness</b>	<b>Appointment, position, or title</b>	<b>Declaration</b>
Don Antonio de Roda	Count of Valle de San Juan. <i>Alguacil mayor</i> of the <i>Santo Oficio</i>	Favourable
Don Juan Bautista Ferro	<i>Familiar</i> of the <i>Santo Oficio</i>	Favourable
Don Diego Jordán	<i>Comisario</i> of the <i>Santo Oficio</i> . <i>Racionero</i> of the cathedral	Favourable
Don Luis Belluga y Vargas	Dean of the cathedral	Favourable
Don José Guerrero	<i>Doctoral</i> of the cathedral	Favourable
Don Mateo Ceballos	<i>Familiar</i> of the <i>Santo Oficio</i>	Favourable
Don Pedro de la Reguera		Favourable
Don Rodrigo Galtero	<i>Regidor perpetuo</i> of Murcia	Favourable
Don José Córcoles Villar	Friar of Santa Catalina	Favourable
Don Jorge Pérez Mejía	Scribe of Murcia	Favourable
Don Antonio Sandoval		Favourable
Don Francisco de Torres Aroca	<i>Regidor perpetuo</i> of Murcia. Knight of Santiago	Favourable

San Andrés. As the questioning of Ventura Fontes's proofs in Madrid shows, this allowed him to be close to influential people at court, and he received friendship and favours from them.

All were high nobles and members of the clergy, and all of them favoured the noble past and purity of blood of the Paz name. They specially praised the qualities of Francisco Paz y Castilla and his father Francisco de Paz. Only one of those questioned, Gabriel García Izquierdo, born in Cuenca and residing in Madrid, knew some of the individuals with the Castilla surname who had postings in the *Consejos Reales*.

At the Murcian interrogation process, where the examiners looked into the Fontes surname, everyone was favourable to Ventura Fontes Paz, declaring the fame, nobility and purity of blood of the Fontes lineage. Some of the names listed as part of the questioning were renowned individuals of the Murcian urban oligarchy and from the *cabildo* of the cathedral, men like Roda, Ferro, Jordán, Belluga, Guerrero, Sandoval, Ceballos and Galtero. Such an attendance shows, once again, the social connection and the ties of solidarity and loyalty among the closed group of families of the nobility.

Most of the testimonies were from individuals either in public office, holding an ecclesiastical position or belonging to the *Santo Oficio*. The selection of interviewees was not random; it was intended to get a unanimous favourable decision.<sup>111</sup> It all looked as if the interests of Ventura Fontes Paz were going to be satisfied, and that once the purity of blood of the Paz and Fontes family names was demonstrated, there was not going to be any impediment for Ventura to obtain a *familiatura* of the *Santo Oficio*.

On the contrary, after all genealogies of the Paz family were examined, an additional, large list of *penitenciados* of the Paz name appeared. During this time, the process of Francisco Rodríguez de la Centena appeared as well – he was a ploughman, imprisoned in 1528.<sup>112</sup> His declaration shows that Frejenal was a municipality with a large majority of *converso* people, which meant that public office positions, many in the hands of the Paz family, had Jewish ancestry in their blood.<sup>113</sup>

Most of the decisions are from the end of the fifteenth century, just when the Jewish population was pushed either to convert to Christianity or to be expelled. It was also the period of the harshest inquisitorial processes, when the statutes of purity of blood were

**Table 2.4** Genealogical antecedents of the Paz family<sup>114</sup>*Penitenciados*

<b>Name</b>	<b>Converso (c)</b>	<b>Appointment or position</b>	<b>Year of penitence</b>
Antonio de Paz	c		
Arias de Paz	c		
Alonso de Paz	c	<i>Alcabalero</i>	
Alonso de Paz		Member of the clergy	
Antonio de Paz (judged twice)	c		
Gómez de Paz	c		
Graduate Juan de Paz Cullar (his father: <i>reconciliado</i> ; his mother: judged; his grandfather: sentenced)		<i>Procurador</i> and lawyer	
Antonio de Paz			1550
Leonor García (spouse of Juan de Paz)			1495
Cristóbal de Paz	c	<i>Clérigo</i> of Frejenal	1541
Francisco de Paz	c		
Catalina Rodríguez (spouse of Francisco de Paz)	c		
Francisco Rodríguez de la Centena			1528

*Inquisitorial antecedents of Rodrigo Paz's family background*

Name	Appointment or position	Verdict	Verdict year
Beatriz González		<i>Reconciliada:</i> heretic <i>judaizante</i>	1491
Rodrigo de Paz (spouse of Beatriz González)	Chemist		
Juan de Paz		Sentenced: heretic <i>judaizante</i>	1494
Cristóbal Rodríguez	Member of the clergy	Sentenced: heretic <i>judaizante</i>	1493
Álvaro de Paz (son of Juan de Paz)		Sentenced	1495
Mayor González (spouse of Álvaro de Paz)		Sentenced: heretic <i>judaizante</i>	1491
Alonso Rodríguez de Mocho (son of Cristóbal de Paz)	Chemist		
Miguel de Paz	Scribe		

*Inquisitorial processes: Suspended*

Name	Appointment or position	Antecedents	Year
Martín de Paz ( <i>converso</i> )		Not convicted	
Rodrigo de Paz		Not convicted	
Álvaro de Paz		<i>Reconciliado</i>	1495

*Inquisitorial processes: Relajados*

Name	Appointment or position	Sentence Year
Gonzalo de Paz		
Beatriz García (spouse of Diego de Paz)		1493

*Inquisitorial processes: Sentenced deceased*

<b>Name</b>	<b>Appointment or position</b>	<b>Antecedents</b>	<b>Sentence Year</b>
Diego de Paz		In his process there is proof of his penitence	1493
Juan de Paz			

*Book of sambenitos*

<b>Name</b>	<b>Appointment or position</b>	<b>Antecedents</b>	<b>Sentence Year</b>
Gonzalo de Paz		<i>Relajado</i>	
Alonso de Paz (son of Juan de Paz)			
Álvaro de Paz			

*Disproved references/information*

<b>Name</b>	<b>Town</b>	<b>Reason for disapproval</b>
Don Martín Moreno de Prado	San Lucar de Barrameda	Given his matrilineal connection with the Paz family in Frejenal
Don Miguel de Bolaños	Frejenal de la Sierra	Given his connection with the Paz family in Frejenal
Don Ignacio Santander	Frejenal de la Sierra	Given his connection with the Paz family in Frejenal
Don Andrés de Palacios Salcedo	Mairena (district of Seville)	Part of the Paz family in Frejenal through lady Ana Alcocer
Don Fernando Ramírez	Marchena (district of Seville)	Grandson of María de Paz

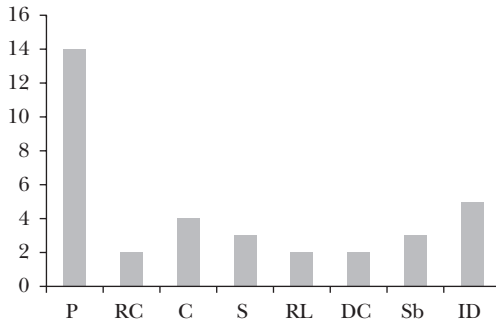

**Graph 2.1** Inquisitorial processes of the Paz family of Frejenal background (1491–1550)

Abbreviations: P (*Penitenciados*), RC (*Reconciliados*), C (*Condenados*), S (*Suspensos*), RL (*Relajados*), DC (*Difuntos Condenados*), Sb (*Sambenitados*), ID (*Informaciones Deprobadas*).<sup>115</sup>

implemented following the growing reformist movement in Europe. Many of the members of the Paz family had Jewish blood because they had left exile in Portugal and had come back to Spain silently, faking conversion by adopting different family names, or by indiscriminately mixing with other families and names of pure blood so that they could hide their past.<sup>116</sup> Extremadura's geographical location on the Portuguese border allowed for this area to have a high number of inquisitorial processes in comparison to other regions in the Spanish territory.<sup>117</sup>

A Jewish individual by the name of Abbedey who came from Portugal and settled in Frejenal at the end of the fifteenth century was probably part of the Jewish population once expelled. He was baptised at the age of eighteen. Francisco de Paz, married to María Alonso, was his godfather, and Abbedey adopted the Paz family name. This led the community to believe that the surname Paz was infected in its roots by those who practised the *Ley de Moisés*. The process behind this one instance becomes more complex as the questions as to real purity of blood increase exponentially over time. The *Consejo Secreto* of Llerena on 13 February 1723 looked at the prosecution process in the cases from the Paz family name. The ones for Antonio, Arias and Gómez de Paz could not be found, though the one for Francisco de Paz was.

He was formerly named Francisco Sánchez de Montemolín and was a chemist and a surgeon. The cases of other processed *conversos* such as another resident of Frejenal, Fernando de Paz, or Ignacio Santander and Miguel de Bolaños, who had not been admitted as *familiar* of the *Santo Oficio*, all had close family ties to the large Paz family.

At first, the *Consejo de la Inquisición* on 9 July 1723 agreed for all the accumulated papers to be returned and that no one with the family name Paz coming from Frejenal was to be admitted when presenting a candidacy for the *Consejo*. As evidence, '*esta el suplicante con gran dolor que le resulta de la ditencion.*'<sup>118</sup> The verdict was almost obvious, and things were not looking good on account of the stained past of Ventura Fontes Paz's family background. The splendour, the famous nobility and the long-time Christian blood from the most illustrious families – who had participated in the reconquest – of the Murcian oligarchy like the Fontes and Riquelme families were greatly threatened. To counteract the menace, they followed a strategy of *actos positivos* of members ascribed to the lineage – through reconstruction of the genealogical line they meant to find out if some of their ancestors had obtained proofs of membership under the most important communities of statutes.<sup>119</sup>

Although the *Pragmática de actos positivos* enacted in 1623 was invalid by the second half of the seventeenth century, the same kind of processes were being considered in the purity of blood cases. In some ways, it made the purity test more relaxed in regard to granting *hábitos* of military orders, *familiaturas* of the *Santo Oficio* and obtaining positions in the *concejo* or ecclesiastical appointments. First, there was mention of important individuals from distinguished positions and professions that were directly related to Ventura Fontes Paz. An extensive relation of surnames and family members from prestigious family names followed, though these rarely had any kinship relation with the candidate. Family names from illustrious lineages such as Bazan – like the admiral of Charles V's Armada, Álvaro de Bazan, or Guzman were mentioned – to show the familial and ancestral relation of the Paz family name with other families of important lineages.<sup>120</sup> The ultimate goal was to demonstrate, by all means necessary, the nobility and purity of blood that ran through the veins of the Paz family members.

Ventura Fontes's grandmother, Ana Polizena Espinosa y Paz, was the daughter of Inés de Paz Marmolejo and Agustín de Espinosa,

Table 2.5 Individuals ascribed to the Fontes-Paz lineage and qualified as *actos positivos*

Name	Position	<i>Familiatura of the Santo Oficio</i>	<i>Hábito in military order</i>	Title	Kinship to Ventura Fontes
Fray Lorenzo Ramírez (from the Order of San Benito)	<i>Calificador</i> of the <i>Santo Oficio</i>				Related to Francisco de Paz (Ventura's great-grandfather)
Padre Diego Tello (from the Order of San Benito)	<i>Calificador</i> of the <i>Santo Oficio</i>				Related to Francisco de Paz (Ventura's great-grandfather)
Fernando Ramírez	<i>Secretario</i> of Seville's Inquisition				Related to Francisco de Paz (Ventura's great-grandfather)
Don Juan Saavedra	<i>Alguacil Mayor</i> of Seville		Knight of Santiago		Related to Francisco de Paz (Ventura's great-grandfather)
Cristóbal Tello		<i>Familiar</i> of the <i>Santo Oficio</i>			Related to Francisco de Paz (Ventura's great-grandfather)
Macías Fontes	<i>Regidor</i> of Murcia	<i>Familiar</i> of the <i>Santo Oficio</i>	Knight of Santiago	First marquis of Torre Pacheco (1692)	Paternal grandfather of Ventura



Table 2.5 Individuals ascribed to the Fontes-Paz lineage and qualified as *actos positivos* (Continued)

Name	Position	Familiatara of the Santo Oficio	Hábito in military order	Title	Kinship to Ventura Fontes
Francisco de Paz	<i>Menino</i> of Queen Mother. <i>Paje</i> of Charles II. <i>Alcalde</i> for the nobility in Frejenal. captain of horses in Flanders		Knight of Santiago		Maternal grandfather of Ventura
Francisco de Paz	<i>Paje</i> of Philip IV		Knight of Santiago		Maternal great-grandfather of Ventura
Juan Tinoco		<i>Familiar</i> of the Santo Oficio			Spouse of María Paz (sister of Francisco de Paz)
Juan Carlos de Bazán	Ambassador to Venice		Knight of Santiago		Related to Nicolasa de Paz (mother of Ventura)

Table 2.5 Individuals ascribed to the Fontes-Paz lineage and qualified as *actos positivos* (Continued)

Name	Position	Familiatura of the Santo Oficio	Hábito in military order	Title	Kinship to Ventura Fontes
García Fernando de Bazán (brother of Don Juan Carlos de Bazán)	Captain at <i>Consejo de Castilla</i>		Knight of Santiago		Related to Nicolasa de Paz (mother of Ventura)
Juan de Guzmán (grandson of García Fernando de Bazán)			Knight of Santiago		Related to Nicolasa de Paz (mother of Ventura)
Melchor de Hoyo (grandson of García de Bazán)	<i>Colegial</i> of Salamanca				Related to Nicolasa de Paz (mother of Ventura)
Fernando de Paz	Cavalry colonel		Knight of Santiago		Related to Nicolasa de Paz (mother of Ventura)
Lorenzo de Cartagena Paz (from the Order of Santiago)	<i>Calificador</i> of the <i>Santo Oficio</i>				Related to Nicolasa de Paz (mother of Ventura)
Sancho de Paz	<i>Comendador</i> of Frejenal		Knight of Santiago		Related to Ventura

**Table 2.6** Interrogation in Frejenal de la Sierra<sup>121</sup>

<b>Witness</b>	<b>Position, profession, or title</b>	<b>Declaration</b>
Don Fernando Jara	Clergyman for minors	Favourable
Don Andrés de la Cámara Soto Moya	<i>Hidalgo</i>	Favourable
Manuel Rodríguez Melo	Ploughman	Favourable
Don Ignacio Santander y Bazan	<i>Hidalgo</i>	Favourable
Don Manuel Jara Quemada	<i>Hidalgo</i>	Favourable
Diego Ríos Benegas		Favourable
Don Francisco Tinoco de Castilla		Favourable
Don Pedro Tinoco (resident of Aracena)	<i>Alférez de Infantería</i>	Against
Don Ignacio Rodríguez Pastrana	<i>Vicario</i> and ecclesiastical judge of the <i>vicaría</i> of Frejenal	Against
Don Juan Bravo de Morales	<i>Presbítero</i>	Favourable
Manuel Rodríguez Ronquillo	Ploughman and botanist	Favourable
Andrés Rodríguez Chacón	Ploughman	Against
Don Francisco Vázquez Calatrava	<i>Presbítero</i>	Favourable
Don Diego González Chacón	<i>Presbítero</i> and <i>vicario</i> of the <i>vicaría</i> of Frejenal	Against
Don Blas Márquez Pastrana	<i>Vicario mayor</i> of the <i>vicaría</i> of Frejenal	Against
Francisco Moreno	Ploughman	Against
Don Ignacio José Rodríguez	Lieutenant <i>presbítero</i> of Santa Catalina	Against
Don Francisco García Mazón	Priest and <i>beneficiado</i> of Santa Catalina	Against
Don Francisco de Arguello Bazan	<i>Hidalgo</i>	Favourable
Don Francisco Díaz Caro	<i>Presbítero</i>	Favourable

**Table 2.6** Interrogation in Frejenal de la Sierra<sup>121</sup> (*Continued*)

Witness	Position, profession, or title	Declaration
Antonio Gómez Parro	Administrator of the Santa Clara nuns	Favourable
Don Alejandro Sánchez	<i>Hidalgo</i> . <i>Regular Mayor</i> for the noble estate of Frejenal	Favourable
Francisco Amaya Martínez	Prosecutor of the <i>Real Justicia</i>	Favourable
Juan Martínez Lázaro	<i>Capellán</i>	Favourable
Gonzalo Rodríguez Quirona	Ploughman	Favourable
Cristóbal Bravo Morales		Favourable
Don José Alfaro Casquete	<i>Regidor perpetuo</i> of Frejenal	Favourable
Francisco Gómez Sarillo	Shoemaker	Favourable
Martín Rodríguez Romero Caro (resident of Cumbres de San Bartolomé)	Ploughman	Favourable
Juan Sánchez de las Amas	<i>Presbítero</i>	Favourable
Agustín Sánchez Parreño	Scribe of the <i>Real Justicia</i> of Frejenal	Favourable
Francisco Vicioso	Ploughman	Favourable
Cristóbal Ríos Maya	Ploughman	Favourable
Juan González Rico	<i>Presbítero</i>	Favourable

governor of Berlanga, born and resident in Llerena and its *regidor*. The informants qualified Doña Ana for her family names, Espinosa from Frejenal and Marmolejo from Berlanga; anything to prove a justification to reaffirm Paz's purity of blood and obtain the *famil-iatura* of the *Santo Oficio* – since the opposite case meant a decline and collapse of the Fontes name without precedent.

Nevertheless, the case got blurred when some witnesses, after the start of the process, passionately declared the Paz family members' impurity of blood. The fear about certain lineage tensions being known was real – for example, Pedro Tinoco, born

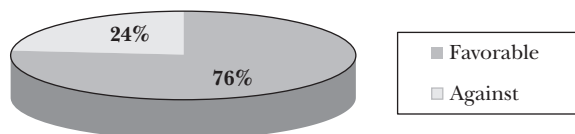

**Graph 2.2** Declarations of the interrogation processes at Frejenal<sup>122</sup>

in Frejenal, resident of Aracena in the jurisdiction of Seville, and *alférez de Infantería*, pointed out that Nicolasa and Francisco de Paz were *cristianos viejos*, and of pure blood, but that it was known that there were some *sambenitos* of the Church of Nuestra Señora de Santa María de Frejenal, and related to Paz, that the *Santo Oficio* had sentenced before.

Feliciano Rodríguez Tinoco, *presbítero* of Frejenal, and Pedro's brother, contradicted his brother's declaration. He was against considering the proofs since he knew that many individuals related to Paz had been condemned and *sambenitados* by the *Santo Oficio* because they were Jewish. Feliciano became a true enemy of the Paz family after the clash with Gonzalo Rodríguez de Bolaños, who was ascribed to the Paz lineage. Feliciano publicly accused Gonzalo of *judeizar* – 'I don't keep the *Mesias* as you do.' Such disgrace needed to be erased; it was vilifying the Paz lineage.

A case of *alcalde* Gonzalo de Bolaños's was ongoing at the *Audiencia Episcopal* of Badajoz after he had revealed that the minister had brought some *cerdos penados* (sentenced pigs) on 8 October 1724. Ignacio Rodríguez de Pastrana, ecclesiastical judge of Frejenal, also accused the Paz name of coming from an impure lineage. The animosity between these two individuals came from a number of offences that Gonzalo Sánchez de Bolaños, as *alcalde* of the noble estate of Frejenal, had committed against his nephew Blas Márquez de Pastrana. Born in Frejenal, Diego González Chacón, *presbítero vicario* of the *vicaría* of this town, also voted against the Paz family as he competed for the position of mayor. An culminating the list of non-favourable declarations was the clash between Juan de Bolaños Paz and Manuel de Prado Basilio Casquete (already dead), when Juan said that he would 'fight him with fire' and Manuel responded that 'he was going to burn like him', accusing him on the central square of being Jewish.

The interrogation at Frejenal opened up conflicts between families that had become enemies a long time before. The Paz centre of

the lineage constantly had to face the attacks that the Rodríguez lineage, favouring families of the *villa* of Frejenal such as Tinoco, Pastrana, Aguilar or Chacon, directed towards them. All of them accused the Paz family – and tried to find evidence of Jewish ancestry. In 1683, when Andrés Rodríguez Chacón was in the city of Jerez de los Caballeros at Pedro Lobo's house, he mentioned, in a decisive way, that even though his niece was married to Miguel de Bolaños in Frejenal and had a 'big nose', she was not Jewish because she had come from the mountains. The physical attributes that were mentioned often were racially and ethnically charged.<sup>123</sup> For example, Isabel Martínez, spouse of Rodrigo de Paz, was called *la chamorra* because of her tough facial features. Isabel Rodríguez, given her slim figure, was known as *la holgada*.<sup>124</sup>

The genealogical tree that the clergyman and resident of Frejenal Diego Arguello had created from the Inquisition books of Llerena shows that these individuals were accused of coming from, and had their origins in, Abbedey. The *Santo Oficio* had sentenced and *relajado* everyone in this genealogy. In parallel, the witnesses who were against the Paz family mentioned the three *sambenitos* of the lineage, one from the Paz surname, another from de Sardiña mill and the third from Diego Pacho.

Behind these accusations there was true hatred, envy and resentment between lineages of the urban oligarchy of Frejenal. The covering of the last names that were linked to the Paz faction – such as Sánchez de Bolaños, Santander y Liaño, Maraver and Castilla – those around the Rodríguez faction tried to vilify and stain the Paz name, which at the time was at the top of the local elite pyramid. As a result, accusations from within the Rodríguez faction emerged.

Baroque society, centred around orality, greatly emphasising public declarations. The constant trading of accusations between enemy factions generated long judicial processes, and to prove these cases was not easy. To counteract the attacks, the Paz family had secured favours from long-time parish priests and scribes – they were the handlers of all genealogical documentation that others with the intention of attacking their honour as *cristianos viejos* could use. For Bartolomé Ramos de Peralta, having the priest *beneficiado* Antonio González de Pina as a loyal friend was key – he was the oldest priest and also scribe of the *cabildo* of Frejenal.

Antonio González de Pina replied to the request for the oldest books in the parish archives by stating that he did not have them.

These might have demonstrated the precedence of the Paz family. Instead, he said that the oldest ones he had access to were the books of 1548. It was likewise with the testimony that Antonio de Paz, Alonso de Paz and Juan de Paz provided for missing instruments and protocols between 1556 and 1569 – that they were not at the *escribanía* – during the very time when many *autos de fe* had resulted in disgraced nobles' names from the local oligarchy.

Some witnesses declared that there had been two Paz surnames in Frejenal; one good and one bad. The good one had come from Salamanca and not left a succession – though it is possible that both names united to create the same family line, since what was important was to avoid the biological extinction of the lineage in such a reduced geographical space. The key was to have institutional, economic, social and political resources in the hands of the lineage – in public office (*regidurías*), in ecclesiastical institutions (*canonjías*), and by creating a *patronato* through founding *obras pías* such as the Monasterio de Monjas de Nuestra Señora de la Paz and the convent of the Society of Jesus (*Compañía de Jesús*). This showed how *cristianísimo* and pious the lineage was, and also the purity of their Catholic blood.<sup>125</sup>

Two important processes were in conflict at this point. On the one hand, the Paz lineage remained without heirs after the death of Francisco de Paz at the beginning of the sixteenth century. The only member of the lineage that was left was Abbedey, the grandson of Francisco de Paz. On the other hand, the accusations of *judeizar* that arose between factions and enemy sides might have been only the result of power envy. Covering the past and alluding to missing documents, however, could end up revealing a fake past – the ostentation and presumption of being *cristianos viejos* through a long list of *actos positivos*, and a stamp from the *fundaciones pías* as shown in Sancho Paz's testament (provided in 1536) and Antonio Paz's (registered on 25 November 1597).<sup>126</sup> These documents were provided to avoid any kind of infamous accusation and prove their Christianity, which also leads to the conclusion that the blood of the Paz lineage was indeed stained.

On the other hand, the commissaries at the *Santo Oficio*, after having qualified the surnames Espinosa and Marmolejo at the *villa* of Berlanga, and considering the *noticias positivas* (positive notifications) and the 'difficulty' of classifying the family name Paz – and

**Table 2.7** Interrogation at the *villa* of Berlanga<sup>127</sup>

<b>Witnesses</b>	<b>Position, profession, or title</b>	<b>Declaration</b>
Doctor Don Cristóbal Díaz y Biznete	<i>Presbítero</i>	Favourable
Pedro Barragán de Valencia	Ploughman	Favourable
Pedro Barragán Muñoz	Ploughman	Favourable
Diego Ortiz Torrejón	<i>Presbítero</i>	Favourable
Alonso López de la Vera	Ploughman	Favourable
Diego Alonso de Toribio Caperuzas	<i>Familiar of the Santo Oficio at Berlanga</i>	Favourable
Pedro Ortiz Valiente	<i>Presbítero</i>	Favourable
Pedro Vera Morales	Ploughman	Favourable
Alonso Muñoz Luengo	Ploughman	Favourable
Isidro Martín del Pilar	<i>Familiar of the Santo Oficio at Berlanga</i>	Favourable
Juan Durán del Castillo	<i>Familiar of the Santo Oficio at Berlanga</i>	Favourable
Diego Díaz Rayo	Scribe at the city hall of Berlanga	Favourable
Alonso Maeso de la Fuente	Commisary at the <i>Santo Oficio</i> of Berlanga	Favourable
Don José Montaña de Guzmán	<i>Alcaide jubilado</i> of the secret prisons of the <i>Santo Oficio</i>	Favourable
Don Antonio Cipriano Guerrero y Torres	<i>Familiar of the Santo Oficio</i>	Favourable
Don José de Parada y Pizarro	<i>Familiar of the Santo Oficio</i>	Favourable
Lázaro Román Blanco	<i>Procurador</i> of Berlanga	Favourable
Francisco Ortiz Holgado	<i>Procurador</i> of Berlanga	Favourable



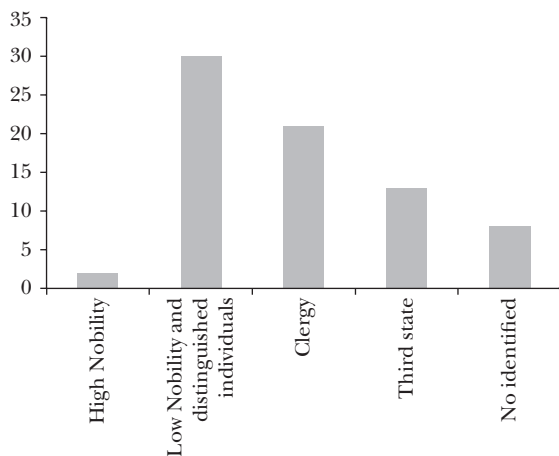

**Graph 2.3** Witnesses' social status<sup>130</sup>

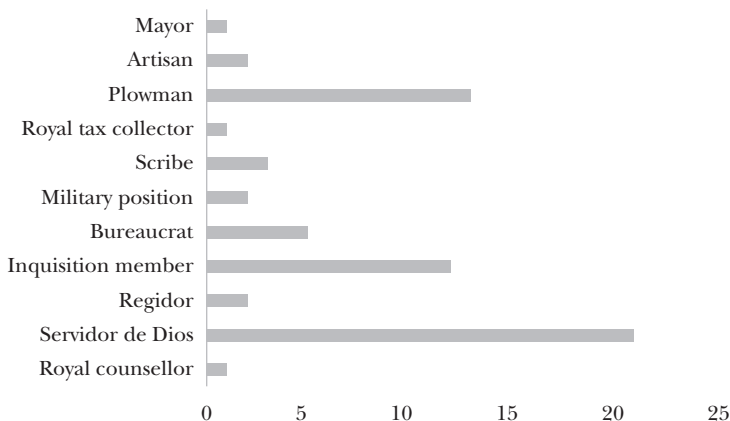

**Graph 2.4** Witnesses' professions<sup>131</sup>

there were ongoing suits between Feliciano Ortiz Tinoco and Gonzalo and Juan de Paz Bolaños, accused of *judaizar* – stated in Murcia on 18 April 1725 – that there was enough information to accept Ventura Fontes Paz as *oficial* of the *Santo Oficio*.

The questions about the Paz lineage were resolved and the Fontes and Riquelme lineages could continue to show off their purity of blood and the celebrity of the families with which they

were mixed. The appointment as *crucesignati* or *familiar* was extremely honourable and prestigious, giving the Riquelme-Fontes the chance to continue blazoning their heraldic symbols during the eighteenth century. The search for cleanliness reached all branches of the lineage – the goal was to get all positive examinations and to avoid more tests. During this time in the Crown of Castile, almost all the consultations, even though they were done because of emerging rumours of impurity, resulted in positive conclusions and almost no calls for proofs.<sup>128</sup>

The crown responded flexibly to most of the instances, especially given the economic benefits of providing *hábitos* of military orders and *familiaturas* of the *Santo Oficio* to stop the draining of the royal coffers. The battle for power and the ambivalence of Spanish baroque society are phenomena that remained vivid and strong in the eighteenth century. Such ambivalence was the double face of Janus reflected in the position of the Castilian crown.<sup>129</sup> On one side, it was versatile to satisfy the traditional and old noble families that could have eased the economic crises, and on the other side, the crown was determined to maintain the social archetype of values established in the statutes of the purity of blood: '*además de ser noble se habría de ser cristiano viejo.*'

## 2.2. Exhibition of Honour or Concealment of Impurity of 'Blood'? Affiliations to Military Orders, the Army and *Regidurías*

Belonging to institutions or enclosed social bodies, classified by the high nobility of their rank, allowed individuals in the Spanish monarchy to show off their honour, their purity of blood and their noble lineage. To wear an *hábito* of a military order (such as Santiago, Alcántara, Calatrava, San Juan or Montesa), to be a member of the *Santo Oficio*, to have a career in the army, or to belong to a noble brotherhood all bestowed status, distinction and social prestige.<sup>132</sup>

All institutions and social groups ran rigorous examinations of *limpieza de sangre* on the candidates. For the most part, social groups remained closed, though when the crown was in economic need, as during the reign of Philip IV and the appointment of count-duc of Olivares, there was more flexibility in granting *hábitos* of

military orders.<sup>133</sup> During these times upward mobility was more evident, especially for the newly wealthy groups who could afford to buy a *hábito*, or for individuals whose merits on the battlefield earned their rise.

Members of the Castilian oligarchy craved obtaining honourable positions or titles. For the Riquelme lineage these were important to maintain their social status, enhance their house honour and avoid any sort of suggestion of stained blood. Beginning in the sixteenth century, and especially after the conflict with the Soto family, their most important goal was to build a glorious *cursus honorum* proof of their long-time *ilustrísimo, nobilísimo* and *cristianísimo* lineage. It was key to belong to certain social groups – the *caballero de hábito* represented the armouring of a Christian society, which became the model that individuals in lower social layers tried to reproduce.<sup>134</sup> The large militias of Alcántara, Santiago, Calatrava or Montesa had gained great prestige after the reconquest, and all military orders, especially the highest, Santiago, never ceased reminding of their role, on paper and in symbols, among those that defended Christianity.<sup>135</sup>

Besides the military orders, cathedral *cabildos*, *concejos*, *Colegios Mayores*, religious orders and the brotherhoods, all included *limpieza de sangre* examinations in their ordinances and constitutions for aspiring applicants.<sup>136</sup> The statutes became a mechanism for social enclosing: the way to verify the honour and quality of the candidates.

The presence of many Riquelme members in these institutions enhanced their *cursus honorum*. Also, marriages with prestigious families helped them preserve the nobility and purity of blood of the lineage. By the end of the sixteenth century, not many central members of the lineage wore *hábitos*. Cristóbal Riquelme de Arróniz (third lord of Santo Ángel), during the first third of the sixteenth century, wore the *hábito* of San Juan, by being *comendador de Paradinas* of San Juan, *encomienda* of the order located in Salamanca, and his son, Pedro Riquelme y Riquelme displayed the *hábito* of Santiago in the mid-sixteenth century.<sup>137</sup> Luis Riquelme y Avilés (fifth lord of Santo Ángel), nephew of Pedro Riquelme, was given the same precious *hábito* in 1588. Macías Coque Riquelme, son of Alonso Riquelme de Comontes (second lord of Coy) and Inés Coque, requested on 8 March 1559 to have the *limpieza de*

*sangre* examinations to be knight of Santiago. Macías, however, died before the examinations started and before he could obtain the position he aspired to.<sup>138</sup>

The main families of the lineage, Coy and Santo Ángel, wore a much-reduced number of *hábitos* – only four in a century, while on average each generation wore one. Adding a collateral branch of the lineage, the Avilés family name, could have helped by adding some *hábitos* to the count.

**Table 2.8** Military order *hábitos* of the Riquelme lineage and related families, sixteenth to eighteenth centuries<sup>139</sup>

Name	<i>Hábito</i>	Year
Cristóbal Riquelme de Arroniz (third lord of Santo Ángel)	San Juan	Second half, sixteenth century
Pedro Riquelme y Riquelme	Santiago	Second half, sixteenth century
Macías Coque Riquelme (lord of Guadalupe)	Santiago	1560
Luis Riquelme de Avilés (fifth lord of Santo Ángel)	Santiago	1588
Pedro de Avilés	Santiago	1542
Bernardo de Avilés	Santiago	Second half, sixteenth century
Francisco Rocamora y Tomas	Santiago	1612
Francisco Rocamora Hostia y Vargas	Santiago	1630
Diego Tomas de Oluja	Alcántara	First half, seventeenth century
Alonso de Almela y Arroniz	Calatrava	First half, seventeenth century
Antonio de la Peraleja	Alcántara	First half, seventeenth century
Cristóbal Fontes de Alborno	Santiago	1630
Juan Fontes de Alborno y Tomas	Alcántara	1638
Fabricio de Alborno	San Juan	First half, seventeenth century

**Table 2.8** Military order *hábitos* of the Riquelme lineage and related families, sixteenth to eighteenth centuries<sup>199</sup> (*Continued*)

<b>Name</b>	<b>Hábito</b>	<b>Year</b>
Baltasar Fontes de Albornoz	San Juan	First half, seventeenth century
Bernardino Fontes de Albornoz	San Juan	First half, seventeenth century
Gonzalo Fontes de Albornoz	San Juan	First half, seventeenth century
Alonso Fontes de Albornoz	San Juan	First half, seventeenth century
Antonio Fontes Riquelme	Santiago	1647
Francisco Tomas Galtero	Santiago	Second half, seventeenth century
Pedro Roca y Ripoll Ferrer de Calatayud	Montesa	Second half, seventeenth century
Francisco Guil	Calatrava	1651
Pedro Fontes Carrillo	Alcántara	1686
Macías Fontes y Carrillo de Albornoz (first marquis of Torre Pacheco)	Santiago	1688
Baltasar Fontes Melgarejo (second marquis of Torre Pacheco)	Santiago	1688
Sancho José Abad y Sandoval	Calatrava	1700
Fernando Melgarejo y Puxmarín	San Juan	1736
José Caro Maza de Lizana y Roca (first marquis of la Romana)	Montesa	1725
Pedro Caro y Fontes	Montesa	1757
Antonio Ventura Caro y Fontes	San Juan	Second half, eighteenth century
José Caro Fontes	San Juan	Second half, eighteenth century
Carlos Caro Fontes (marquis of Malferit)	Montesa	1757
Pascual Caro y Fontes	Montesa	1757

The more family and blood ties, the higher the percentage of *hábitos*. In the seventeenth century there were unions with families like Fontes, Rocamora, Bienvengud, Salafranca, Melgarejo, Peraleja, Galtero, Tomas, Guil, Caro, Roca, Valcárcel, Puxmarín and Abad Sandoval, with diverse social trajectories that increased honours such as the wearing of a military *hábito*, and also allowed entry to the network of illustrious and titled families. The number of members from the Fontes lineage that became tied with the Riquelme lineage, for example, increased exponentially during the seventeenth and eighteenth centuries.

Graphs 2.5 and 2.6 show that there was an increase in the number of *hábitos* in the hands of the Riquelme lineage and related families during the seventeenth century. It was the result of the Castilian

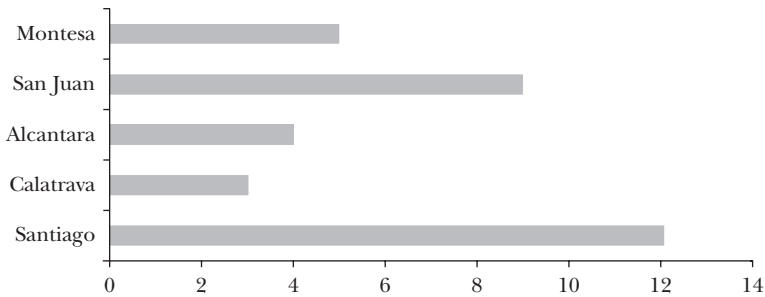

**Graph 2.5** Membership of military orders by the Riquelme lineage and related families, sixteenth to eighteenth centuries

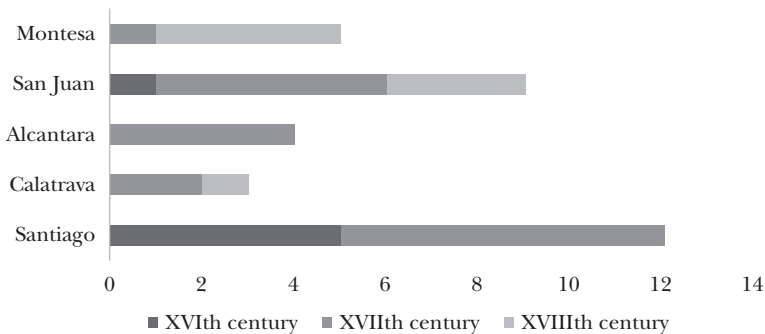

**Graph 2.6** *Hábitos* in the hands of the Riquelme lineage and related families, sixteenth to eighteenth century

crown's need to sell *gracias* and *mercedes* during the reign of Philip IV, but also a consequence of the constant marriage alliances between the Riquelme and the Fontes lineages. The strategy focused on marrying within a close group of families of the urban oligarchy to increase the benefits from honours for the Riquelme lineage. This was done even with well-established families originally from the kingdom of Valencia, which allowed the Fontes lineage to increase the possession of *hábitos* of the Montesa order in the eighteenth century.<sup>140</sup> This increase in the seventeenth and eighteenth centuries counterbalanced the limitations to concessions that Charles II implemented in the same way as Philip V's reign.<sup>141</sup>

As a result of the decrease in the availability of *hábitos*, the Riquelme-Fontes lost influence in the military orders of Santiago, Calatrava and Alcántara (see graphs 2.5 and 2.6). Although the percentage remained similar in the order of San Juan in the seventeenth century, and only slightly decreased in the Calatrava order, the Riquelme-Fontes lineage completely lost their presence in the illustrious and respected orders of Santiago and Alcántara.

By being related to the most illustrious names, the Riquelme were looking to imbue the lineage with symbols of nobility. And this was a difficult enterprise for the Riquelme, a burden that lasted through the sixteenth and seventeenth centuries. Marriage with important families was therefore essential, and this is how the lineage remained linked to noble families through the eighteenth century.

For example, Petronila Riquelme de Avilés, who made her will in 1613, was the granddaughter of Gonzalo Rodríguez de Avilés and Isabel Fontes, counts of Albatera.<sup>142</sup> The granddaughter of Antonio Fontes Riquelme and Claudia Carrillo Marín, Patricia Fontes Bienvenud married, in the parish of San Miguel de Murcia on 2 October 1710, José Caro y Roca, born in Elche and living in Valencia, marquis of la Romana (title given by Philip V) and also made a holder of the *hábito* of the order of Montesa on 9 January 1725.<sup>143</sup> The marquises of Valdeguerrero, Gabriel Ortega, and María Josefa Sandoval y Guerrero, were the parents-in-law of the brother of Patricia Fontes, Antonio Fontes Carrillo y Bienvenud y Arce.<sup>144</sup>

Within only one generation, the Fontes were able to gather a large number of military orders' *hábitos*. It was the children of José Caro and Roca y Patricia Fontes who entered the order of San Juan;

Antonio Ventura Caro y Fontes and José Caro y Fontes, *alférez de Justicia del Regimiento de Dragones* of Numancia, also wore the San Juan *hábito*.<sup>145</sup> On the same day, on 18 April 1757, the brothers Pedro Caro Fontes (marquis of la Romana), Carlos Caro y Fontes (born in Orihuela, *capitán del Regimiento de Dragones* of Batavia) and Pascual Caro y Fontes (born in Valencia) were vested as knights of the order of Montesa.<sup>146</sup>

The Fontes then became directly tied to the titled nobles of the kingdom of Valencia – those holding the marquisate of la Romana, and the Roca, in possession of the Malferit marquisate – and so did, indirectly, the Riquelme.<sup>147</sup> Francisca Riquelme y Buendía was married to Antonio Fontes Paz, third marquis of Torre Pacheco, and thus the title directly reverted to the Riquelme name in the mid-eighteenth century. Antonio Fontes (also second cousin of Fernando Melgarejo Puxmarín, who assumed the knight *hábito* of the order of San Juan on 4 July 1736), and Francisca Riquelme's first-born son Joaquín Fontes Riquelme, was fourth marquis of Torre Pacheco.<sup>148</sup>

Through the titles of nobility closely linked to the Riquelme-Fontes, they reinforced their noble position. Also, they were able to show, through genealogy, in the *limpieza de sangre* examinations, that they were related to higher noble families. The processes of Francisco de Borja Fontes Riquelme in 1771, and of his son Antonio Fontes Abad in 1797 were evidence of the strategy.<sup>149</sup>

**Table 2.9** Nobility titles presented during *limpieza de sangre* examinations of Francisco de Borja Fontes Riquelme and Antonio Fontes Abad

<b>Francisco de Borja Fontes Riquelme</b>	<b>Antonio Fontes Abad</b>
Count of Montealegre Marquis of Albudeite Marquis of Corvera Count of Valle de San Juan Marquis of Valdeguerrero Marquis of la Romana	Count of Montealegre Marquis of Albudeite Count of Valle de San Juan Marquis of Valdeguerrero Marquis of Corvera and lord of Cotillas Marquis of San Mamés Viscount of Huertas Marquis of la Romana Count of Balazote



Other individuals in the Fontes lineage, *caballeros de hábito*, alluded to their military career as a means to rise socially. In the eighteenth century, the militia honour was recovered after the Bourbon reforms. The army was, once again, ‘a school of honour, strong arm and symbol of the *patria*’.<sup>150</sup> The militia was an honourable profession and thus it conferred honour on those who were part of it.<sup>151</sup> Such was the case of the Salafranca family, settled in Cartagena and wealthy because of commerce. Gaspar Salafranca was the first of his name to settle in Cartagena, and he was from Valencia.<sup>152</sup> The Salafranca–Riquelme link began in the seventeenth century through the marriage of Antonia Riquelme and Francisco Ignacio de Salafranca. The family’s social upward mobility process was based on the military career of some of the members in the marine, especially between the late seventeenth century and throughout the eighteenth century. The social status of the family and its sociopolitical power increased as a result of their noble positions in the *Consejos Reales*. Then, in 1700, Bernardo Riquelme requested of His Majesty the title of marquis of Pinares – a title created that same year – and although he was denied then, in 1763 Bernardo Riquelme Salafranca y Rocha would purchase it for 330 *ducados* to be paid annually and the related expenses in the Spanish court and those needed to pay the caretaker and repair worker of the *mayorazgos*.<sup>153</sup>

It was not until well into the eighteenth century that the Riquelme family was fully part of the titled nobility. The marquisates of Pinares and of Torre Pacheco were the titles that provided the lineage with the most splendour and prestige during the eighteenth century.<sup>155</sup> These, however, were

**Table 2.10** Military positions in the *Consejos Reales* exercised by Riquelme and Fontes members, sixteenth to eighteenth centuries<sup>154</sup>

Name	Position	Date
Diego Fontes Ortega	<i>Guardia de Marina</i> of the Royal Academy	20 July 1744
Joaquín Riquelme Salafranca y Fontes	Lieutenant-Colonel of Infantry	Second half, eighteenth century

**Table 2.10** Military positions in the *Consejos Reales* exercised by Riquelme and Fontes members, sixteenth to eighteenth centuries<sup>154</sup>  
(Continued)

Name	Position	Date
Bernardo Riquelme y Salafranca	President of the <i>Tribunal</i> of the <i>contaduría mayor de cuentas</i> (Treasury), resident of the <i>villa</i> and court of Madrid	First half, eighteenth century
Justo Riquelme Riquelme y Salafranca	<i>Guardiamarina</i> (1741). Lieutenant of vessel (1757) and captain of marine battalions. Main sergeant of the marine battalions in the Department of Cartagena	First half, eighteenth century
Pedro Riquelme y Salafranca	Lieutenant-Colonel of the Royal Armies	First half, eighteenth century
Lino Riquelme y Salafranca	<i>Alférez Mayor</i> of Cartagena. <i>Pagador</i> for the king at the <i>galeras</i>	First half, eighteenth century
Joaquín Fontes Riquelme	<i>Alférez mayor</i> of Murcia	Second half, eighteenth century
Justo Salafranca y Riquelme	Captain of the frigate of the Royal Army. <i>Brigadier de Marina</i> in the Department of Cartagena, resident in the port of Algeciras	First half, eighteenth century
José Caro	Colonel in the <i>Regimiento de Dragones</i> of Cartagena	First half, eighteenth century
Carlos Caro Maza y Lizana	Colonel of cavalry on the coast of the kingdom of Valencia	Second half, seventeenth century
José Caro y Roca (marquis of la Romana)	Colonel of <i>Dragones</i> . Military governor of the castle of the <i>villa</i> of Montesa	First half, eighteenth century
José Caro Fontes	<i>Alférez</i> of Justice of the <i>Regimiento de Dragones</i> of Numancia	First half, eighteenth century

**Table 2.10** Military positions in the *Consejos Reales* exercised by Riquelme and Fontes members, sixteenth to eighteenth centuries<sup>154</sup>  
(Continued)

Name	Position	Date
Antonio Fontes Riquelme	<i>Alférez Mayor</i> of Murcia	First half, eighteenth century
Francisco González de Avellaneda y Sandoval	Colonel of Infantry	First half, eighteenth century
Francisco Alonso de Paz	<i>Capitán de Caballos</i> in Flanders	First half, seventeenth century
Francisco Alonso de Paz y Castilla	<i>Capitán de Caballos</i> in Flanders	Second half, seventeenth century

second-class titles that were acquired either through the Castilian crown's venality and its economic need, or because of favours among individuals with strong family ties who were in high relevant positions.

Other indirect or remote relations with the rest of the titled nobility helped Riquelme members to highlight and exaggerate their noble past as shown in the *limpieza de sangre* records for Riquelme and Fontes cases when they became *regidor*, when requesting a *familiatura* of the *Santo Oficio* or when seeking to be part of a noble brotherhood. The *limpieza de sangre* records of the marquis of Pinares's request for a *familiatura* of the *Santo Oficio* on 16 June 1788 listed both noble ancestors and related family members so that the already sentenced Manuel de Molina, *regidor* of Mérida, was not taken into consideration to dismiss his case. It is a sign of the flexibility of the eighteenth century regarding the *honoros* and *mercedes* that the *Consejo de Inquisición* approved the *gracia* to the marquis of Pinares, Bernardo Riquelme Salafranca y Rocha Leonés Yuste Ponce de León, to be official minister of the *Santo Oficio*.<sup>156</sup>

After king Ferdinand VI granted Murcia an *estatuto nobiliario* in 1751, all *regidores* were required to be nobles, and only allowed in the position with favourable strict *pruebas de nobleza*.<sup>157</sup> Although these examinations were possibly common before, the first evidence is from 1751. The Riquelme-Fontes accumulated *regidurías* during the reigns of Philip III and Philip IV when the privatisation of positions, using the *juro de heredad*, was easily processed (see graph 2.7).<sup>158</sup> The Crown of Castile pushed for such a process, and also for the creation and selling of positions, which was extremely profitable and necessary to balance the economic deficit.

When Charles II succeeded, this process slowed down, and the number of Riquelme-Fontes *regidurías* also decreased (see graph 2.7). During the eighteenth century, there was an attempt to revive the accumulation of these positions, but it never went back to the tendencies of previous periods (see graph 2.7 and table 2.11). Under Charles III's reign, there were more Riquelme-Fontes *regidurías*, as well as other important positions such as *alcaldes ordinarios*, *por el estado noble y de huerta*, or like the case of Bernardo Riquelme Salafranca y Rocha (marquis of Pinares), who was both the *procurador síndico general* of Murcia and *alcalde ordinario*.

**Table 2.11** *Regidurías* of the Riquelme-Fontes, seventeenth and eighteenth century<sup>159</sup>

Name	Date
Juan Fontes de Albornoz	1646–8
Luis Fontes de Albornoz	1597–1603
Antonio Fontes Riquelme	1610–43
Pedro Fontes de Verástegui	1643–51
Cristóbal Riquelme	1619–20
Lorenzo Riquelme de Barrientos	1603, 1615–19
Cristóbal Riquelme de Comontes	1592–1604
Diego Riquelme de Comontes	1647–9
Sebastián Riquelme de Comontes	1645, 1649
Francisco de Rocamora Riquelme	1645–?
Miguel Valcárcel Riquelme	1589–1610

**Table 2.11** *Regidurías* of the Riquelme-Fontes, seventeenth and eighteenth century<sup>159</sup> (Continued)

<b>Name</b>	<b>Date</b>
Francisco de Valcárcel Riquelme Villaseñor	1641–2
Ambrosio Fontes Carrillo	End of the seventeenth century
Antonio Fontes Riquelme	First half, seventeenth century
Baltasar Fontes	First half, seventeenth century
Pedro Fontes Carrillo	End of the seventeenth century
Antonio Fontes Carrillo Bienvenida y Arce	1697
Baltasar Fontes Barrionuevo	1696
Antonio Fontes Ortega (owner of three positions, but never exercised any of them)	First half, eighteenth century
Francisco de Borja Fontes Riquelme	1771
José María Fontes Abad	1800
Antonio Fontes Abad	1797
Joaquín Riquelme y Togores	1742–62
Antonio Fontes Paz (third marquis of Torre Pacheco)	1759
José Fontes Carrillo y Barrionuevo	1753
Francisco Fontes Pérez de Merlos	1772
Bernardo Riquelme Salafranca (marquis of Pinares)	1721
Baltasar Fontes	1721
Lino Riquelme Salafranca ( <i>regidor</i> of Cartagena)	First third, eighteenth century
Joaquín Fontes de la Reguera	1830

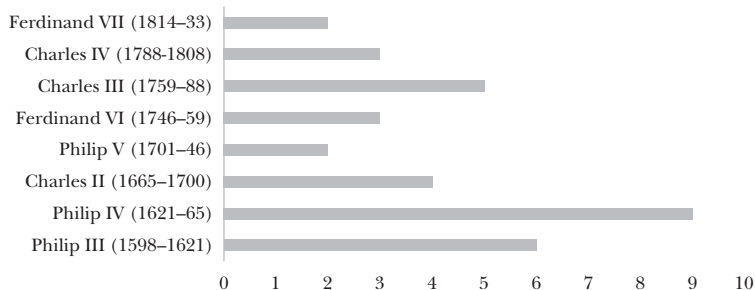

**Graph 2.7** *Regidurías* of the Riquelme-Fontes (1598–1833)

**Table 2.12** Riquelme-Fontes appointed as *alcaldes*<sup>160</sup>

Name	<i>Alcalde for the Nobility (AN)</i>	<i>Alcalde Ordinario (AO)</i>	<i>Alcalde de Huerta (AH)</i>	Fecha
Macías Fontes de Albornoz y Riquelme	AN			Start of the seventeenth century
Rodrigo Puxmarín		AO		1662
Francisco Melgarejo		AO		1670
Gaspar Puxmarín Melgarejo		AO	AH	1672 (AO) 1674 (AH)
Pedro Fontes Carrillo				1688
Pedro Fontes de Albornoz	AN			First half, seventeenth century
Diego Fontes Melgarejo	AN	AO		1713 (AH) 1716 (AO)
Antonio Fontes Paz	AN			Second half, seventeenth century

**Table 2.12** Riquelme-Fontes appointed as *alcaldes*<sup>160</sup> (Continued)

Name	<i>Alcalde for the Nobility (AN)</i>	<i>Alcalde Ordinario (AO)</i>	<i>Alcalde de Huerta (AH)</i>	Fecha
Bernardo Riquelme Salafranca y Rocha (marquis of Pinares)	AN			Second half, eighteenth century
Joaquín Riquelme y Togores		AO		1733
Antonio Fontes Abad		AO		1784

On 11 September 1758, José Fontes Barrionuevo, the civic council's *regidor*, declared officially that he

gives, renounces and transfers his right to this position for the rest of his life to Don Antonio Fontes Paz, resident of Murcia, because he has the right qualities and these are the right circumstances that are required to be *regidor*, which he can hold for all the time he wants. And he asks His Majesty to approve this request.<sup>161</sup>

The king had the final right both to approve the transfer to Antonio, third marquis of Torre Pacheco, and also to terminate it. Appointing public office positions was a royal privilege.<sup>162</sup> Once the king approved, a civic council commission had to start the required *hidalguía y limpieza de sangre* examination process. For this, the candidate explained his illustrious, *hidalgo* and 'pure Christian blood' lineage through a genealogical display.<sup>163</sup>

It was Charles III who awarded the position of *regidor* to the marquis, by *juro de heredad*, and he began in the post on 26 October 1759. He paid 28,518 *maravedíes* for the position, for half its value and a third of its profits. Nine years later, Antonio Fontes Paz resigned, and his son Joaquín Riquelme y Fontes became *regidor* as well as fourth marquis of Torre Pacheco.<sup>164</sup> During this time also, between 1742 and 1762, Joaquín Riquelme y Togores, father-in-law of Antonio Fontes Paz, had the same position.

In 1771, Francisco de Borja Fontes y Riquelme, grandson of Joaquín Riquelme y Togores and son of Antonio Fontes Ortega, went through the *limpieza de sangre* examination process. Antonio was then judicially in possession of the title of *regidor*.<sup>165</sup> Antonio Fontes Abad, having passed the *hidalguía* examination, became *regidor* after his father Francisco de Borja Fontes died in 1797, though he never served in the position, and thus in 1801 he was given another title so that he could hold the post. One year before, his brother José María Fontes Abad had started on another *regidor* position.<sup>166</sup> Although decreasing in the reign of Charles IV, the Riquelme-Fontes continued holding many of the posts – their role in the sociopolitical sphere was far from over. Still, by the end of the eighteenth century, their influence in the Murcian *concejo* was significant, all because of the family ties they had woven with the oligarchy that served in the city hall.

### 2.2.1. Affiliation to the Holy Office and Noble Guilds: Santiago de la Espada and San Pedro Martir

The origins of *cofradías* or brotherhoods were diverse, but most were created around the idea of charity and infused with the principles of spiritual and social protection.<sup>167</sup> These organisations need to be understood in the context of the European Counter-Reformation – mainly to face Lutheran proposals. But most importantly, as these played an essential role, they are also a reflection of feudal, traditional Spanish society. Entry to some *cofradías* ultimately depended on social status.<sup>168</sup>

In the Castilian crown, nobility *cofradías* strongly defined their identities through social prestige, also establishing particular norms in a number of matters to define the moral and social profile of the possible candidates. The rules had an important role in social enclosing processes as well as in any kind of upward mobility. In addition, *cofradías* became ‘family clubs’, with ordinances that aided family recruiting.<sup>169</sup>

Rigorous *limpieza de sangre* examinations became part of *cofradías* by-laws to assure the illustrious noble provenance of all members. *Limpieza de sangre* interrogations were used widely in all kinds of bureaucratic bodies. *Cofradías* were organisations where these examinations were important, and particularly in the case of the Riquelme y Fontes. The *Cofradías* of Santiago de la Espada and San Pedro Mártir de Verona had had these names associated with



them since their foundation. Members of the Riquelme and Fontes held key positions in these brotherhoods and they also used them to establish important family and social connections.

The *hidalga Cofradía* of Santiago de la Espada was founded in the late medieval period and established a *limpieza de sangre* statute in the early fifteenth century – most likely the oldest in the city.<sup>170</sup> The indirect references to it, and the very few pages left from the statute, show that it was close to what the Santiago order practised, and ‘ordered that everyone with an *hábito* in this order had to be *hijodalgo* (noble) by blood from the father’s and mother’s sides, instead of by concession’.<sup>171</sup>

The statutes of this *cofradía*, which celebrated its *cabildos* and meetings at the Murcia civic council, were implemented after 1751, when the city obtained the *estatuto de nobleza* privilege. Most of its members were *regidores*, and it was in need of reorganisation as the following statement from the *cabildo* of 18 June 1798 shows:

To honour the request of Jesualdo Riquelme y Fontes to recognise the archives of this *cofradía* so that the statutes can be rewritten to keep and observe; and that *mayordomos* take them into consideration and for the applicant *cofrades* to learn and with knowledge they can take into account these matters in the *cabildos*, and also the privileges of the *Cofradía*. As such, Jesualdo Riquelme y Fontes agrees with José Fernández de la Reguera, to recognise such documents and proceed to conform and better instruct the members of this *cofradía*.<sup>172</sup>

*Limpieza de sangre* examinations, adapted to Murcia’s *estatuto de nobleza*, were a common practice with new candidates at the *Cofradía*. The marquis of Pinares Bernardo Riquelme Salafranca y Rocha’s interrogation on 7 June 1784 shows such a process when he applied to be a member:

Having reviewed the documents of Bernardo Riquelme Salafranca y Rocha, marquis of Pinares, knight *maestrante* of the *Real de Granada*, these say that his family is from this city [Murcia], of illustrious and distinguished heritage, which makes him worthy of this illustrious *cofradía*, named by one of its *mayordomos*, his great-grandfather Bernardo Salafranca, and has practised with other candidates, and seeking to be part of the service and cult of Señor Santiago de la Espada, begs this illustrious *cofradía* to accept him among its *cofrades*, which favour he dearly appreciates; and before starting this process, the following left this room: Antonio Fontes Paz, father-in-law of the

marquis, Francisco de Borja Fontes y Riquelme and Nicolas de Avellaneda y Fontes, as his cousins; and to start the panel they assure that the candidate is of noble blood, and has family ties with the main houses of this city, and that if his father Pedro Salafranca and his grandfather Lino were not *cofrades* and *mayordomos* of this *cofradía* it was because they were serving the marquisate in its royal armies in different locations . . . agreement to vote with *abas negras y blancas* as it is done; and the result agreed to name and admit as *cofrade*, and to proceed with the regular oath to one of the *mayordomos* and pay the common dues.<sup>173</sup>

To be a member of the *cofradía*, or for those who sought to become *mayordomos*, the examination of the *memorial de hidalguía* was rigorous. Presenting the proposal to the *cabildo* was the next step, in case there was a member that opposed the request. And if there were family members in the *cabildo* they had to leave the room so that the rest could proceed to vote with white and black beans. The designation of *regidores* and their oath in the position followed the same steps.

The nobility thus remained enclosed, and the relationships forged within the *regidurías* continued to be strong. Fidelity and kinship ties prevailed. A unique, unified group of *regidores* and members of the *Cofradía Hidalga de Santiago de la Espada* then emerged within the local urban oligarchy.

**Table 2.13** Riquelme-Fontes in the *Cofradía* of *Santiago de la Espada*<sup>174</sup>

Name	Position	Date
Rodrigo Puxmarín		
Francisco Melgarejo		
Gaspar Puxmarín y Fajardo	<i>Alférez Mayor</i>	1671
Baltasar Puxmarín y Fajardo		
Macías Fontes Carrillo (first marquis of Torre Pacheco)		
Diego Melgarejo y Fontes (enters the <i>Cofradía</i> in 1699)	<i>Mayordomo.</i> <i>Alférez Mayor</i>	1713 1704
Fernando Melgarejo y Puxmarín (enters the <i>Cofradía</i> in 1727)		
Antonio Fontes Carrillo Bienvendud y Arce	<i>Mayordomo</i> and <i>Alférez</i>	1704

**Table 2.13** Riquelme-Fontes in the *Cofradía* of *Santiago de la Espada*<sup>174</sup>  
(Continued)

<b>Name</b>	<b>Position</b>	<b>Date</b>
Antonio Fontes Ortega y Zambrana	<i>Mayordomo.</i> <i>Alferez Mayor</i>	1754 1751
Francisco de Borja Fontes y Riquelme	<i>Mayordomo</i>	1771, 1775, 1783
José María Fontes y Abad (enters the <i>Cofradía</i> in 1789)	<i>Mayordomo</i>	1799– 1800
Estanislao Fontes y Abad (enters in the <i>Cofradía</i> in 1789)	<i>Mayordomo</i>	1804–5
Antonio Fontes Abad (enters in the <i>Cofradía</i> in 1789)	<i>Mayordomo.</i>  <i>Alferez</i>	1794–5, 1798–9, 1804, 1806–7, 1810–11, 1815–16 1798
Joaquín Riquelme y Togores	<i>Mayordomo</i>	1728, 1747
Jesualdo Riquelme y Fontes	<i>Mayordomo</i>	1773
Antonio Riquelme y Fontes	<i>Mayordomo</i>	1794–7
Antonio Fontes Paz (third marquis of Torre Pacheco)	<i>Mayordomo.</i> <i>Procurador</i> <i>Síndico General.</i> <i>Encargado del</i> <i>Paño de</i> <i>entierros.</i> <i>Clavario</i>	? 1780–4, 1796 1773, 1778  1785–92
Joaquín Fontes Riquelme (fourth marquis of Torre Pacheco)	<i>Mayordomo.</i> <i>Comisario.</i> <i>Procurador</i> <i>General</i>	1778 1809 1797– 1810
José María Fontes Fernández de la Reguera (enters the <i>Cofradía</i> in 1805)	<i>Mayordomo</i>	1806–7, 1819

**Table 2.13** Riquelme-Fontes in the *Cofradía* of Santiago de la Espada<sup>174</sup>  
(Continued)

Name	Position	Date
Bernardo Riquelme Salafranca y Rocha (marquis of Pinares), enters the <i>Cofradía</i> in 1784	<i>Mayordomo</i>	1785–6
Joaquín Riquelme Salafranca y Fontes (enters in the <i>Cofradía</i> in 1792)	<i>Mayordomo</i>	1793–4
José Riquelme Salafranca y Fontes (second marquis of Pinares), enters the <i>Cofradía</i> in 1785	<i>Mayordomo. Procurador General</i>	1787–8, 1820–1 1815–16
Pedro Fernández de la Reguera y Sandoval		

The inquisitorial *Cofradía* of San Pedro Mártir de Verona shows a similar pattern. Its foundation location was Murcia, in 1603, and its first constitutional rules were from 1607.<sup>175</sup> Although its statutes do not allude specifically to the *limpieza de sangre*, chapter two declares that ‘it is declared the way to make officials and ministers of the *Santo Oficio*; in consideration of the *Alguacil Mayor*, secretaries, and the rest of ministers of the *Santo Oficio* . . . they need to be admitted by *cofrades*.<sup>176</sup> Chapter three then mentions that ‘anyone that is a minister or *familiar* of the *Santo Oficio* is admitted.’<sup>177</sup> No examination was needed to accept those individuals – they were already honourable, being or having been part of the Inquisition. All its members should belong to the *Santo Tribunal*. Although there is no clear reference in the sources to the exact number of Riquelme-Fontes members ascribed, it is safe to assume that the ones who were *familiares* of the *Santo Oficio* or had a position in the Inquisition also belonged to the *Cofradía* of San Pedro Mártir de Verona.

Besides the pious and welfare functions of the *cofradías*, their most important mission was to eradicate heresy: ‘anyone that becomes *cofrade*’, chapter four states, must take an oath ‘to serve the *Santo Oficio* diligently . . . and to denounce before the tribunal any heretical offence’.<sup>178</sup>

And, in addition, *inquisidores*, officials, ministers and *familiares* of the *Santo Oficio* received *bulas apostólicas*, privileges and indulgences from Popes Urban IV, Clement IV, Gregory IX, Clement VII and

**Table 2.14** Riquelme-Fontes in the *Cofradía* of San Pedro Mártir de Verona.<sup>179</sup>

Name	Position	Date
José Caro y Roca	Marquis of la Romana, <i>prior</i> of the <i>cofradía</i> in Valencia	1749–50
Luis Riquelme y Avilés	Fifth lord of Santo Ángel, <i>prior</i> of the <i>cofradía</i>	early eighteenth century
Macías Fontes Carrillo		

Pius V, ‘to the *Crucesignatos* or *familiares* of the *Santo Oficio* [. . .] that every time they burn a heretic they receive a *Privilegio de Indulgencia Plenaria*, a privilege for those who favour the Holy Land’.<sup>180</sup> Members of the urban oligarchy thus craved being part of a *cofradía* – it conferred qualities such as being *cristiano viejo*, of having noble ancestry, and of having a deep defence of Christianity. In the public sphere, it translated into a symbol of honour and fervent Catholicism.

The Riquelme-Fontes also belonged to other brotherhoods such as the noble *cofradías* of San Salvador, Chinchilla and San Ildefonso, on the side of Macías Fontes Carrillo (first marquis of Torre Pacheco), and the *cofradías* of Nuestra Señora de la Soledad, the one in the kingdom of Valencia, on Caro Fontes’s side, or the *Cofradía* of Santo Cristo through Lino Salafranca.

**Table 2.15** Riquelme-Fontes with positions in the *Santo Oficio*, sixteenth to eighteenth century<sup>181</sup>

Name	Position	Date
Luis Riquelme y Avilés (fifth lord of Santo Ángel)	<i>Familiar</i> <i>Capitán de</i> <i>Familiares</i>	1580 1612
Sebastián Riquelme	<i>Familiar</i>	1642
Juan de Loyola Molina (husband of Florencia Riquelme)	<i>Familiar</i>	1640
Antonio Fontes Riquelme	<i>Familiar</i>	First half, seventeenth century

**Table 2.15** Riquelme-Fontes with positions in the *Santo Oficio*, sixteenth to eighteenth century<sup>181</sup> (*Continued*)

<b>Name</b>	<b>Position</b>	<b>Date</b>
Alonso Riquelme	<i>Alguacil Mayor</i>	Second half, sixteenth century
Alonso de Roda	<i>Consultor</i> <i>Juez de bienes confiscados</i>	Second half, sixteenth century Second half, sixteenth century
Diego Martínez Galtero	<i>Familiar</i>	First half, seventeenth century
Juan de Junco	<i>Tesorero</i>	First half, seventeenth century
Juan Marín Blázquez	<i>Alguacil Mayor</i>	First half, seventeenth century
Gonzalo Fontes de Albornoz y Pagán	<i>Calificador</i>	Start of the seventeenth century
Pedro Fontes de Albornoz	<i>Familiar</i>	Second half, sixteenth century
Macías Fontes de Albornoz y Riquelme	<i>Familiar</i>	Start of the seventeenth century
Macías Fontes Carrillo (first marquis of Torre Pacheco)	<i>Familiar</i>	Second half, seventeenth century
Ventura Fontes Paz	<i>Familiar</i>	1725
Bernardo Riquelme Salafranca y Rocha (marquis of Pinares)	<i>Familiar</i>	1788

**Table 2.15** Riquelme-Fontes with positions in the *Santo Oficio*, sixteenth to eighteenth century<sup>181</sup> (*Continued*)

<b>Name</b>	<b>Position</b>	<b>Date</b>
Joaquín Fontes Riquelme	<i>Familiar</i> <i>Alguacil Mayor</i>	Second half, eighteenth century Second half, eighteenth century
José Buendía (uncle of Ana Buendía, wife of Joaquín Riquelme y Tогores)	<i>Alguacil</i>	First half, eighteenth century
José Caro y Roca (marquis of la Romana)	<i>Familiar</i>	First half, eighteenth century
Francisco González de Avellaneda	<i>Familiar y Alguacil Mayor</i>	1717
Antonio Fontes Abad	<i>Familiar</i>	Second half, eighteenth century
Joaquín Fontes Riquelme	<i>Familiar</i> <i>Alguacil Mayor</i>	Second half, eighteenth century Second half, eighteenth century
José Buendía (uncle of Ana Buendía, spouse of Joaquín Riquelme y Tогores)	<i>Alguacil</i>	First half, eighteenth century
José Caro y Roca (marquis of la Romana)	<i>Familiar</i>	First half, eighteenth century
Francisco González de Avellaneda	<i>Familiar y Alguacil Mayor</i>	1717
Antonio Fontes Abad	<i>Familiar</i>	Second half, eighteenth century

**Table 2.16** Caro Fontes members of the *Cofradía* Nuestra Señora de la Soledad de Valencia<sup>182</sup>

Name	Position	Date
Pedro Caro y Roca	Marquis of la Romana	
José Caro y Roca	Marquis of la Romana	
Pedro Caro y Fontes		
Diego Ruíz		

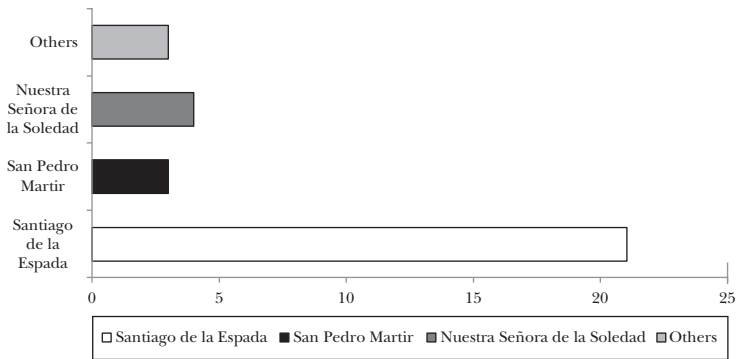
**Graph 2.8** Riquelme members in nobility *cofradías*, sixteenth to eighteenth century

In the Spanish monarchy both religious and civil powers were closely linked through enclosed spaces of sociability such as the noble brotherhoods. The *Cofradía* of Santiago was tied to the *regidores* and that of San Pedro with the *familiares* of the *Santo Oficio*. Both power blocs were controlled by a reduced group of the oligarchy, with some prominent families that bonded over strong kinship ties.

One institution where the Riquelme and Fontes lineages had little to no presence was the *Colegios Mayores*, where strict *limpieza de sangre* examinations were also common.<sup>183</sup> There is no evidence of a broad participation in *Colegios* – only Antonio Fontes Ortega participated in Salamanca when he studied on a scholarship. He later was *colegial mayor*, and also dean, in the *Colegio Mayor* of Cuenca.<sup>184</sup> He had a long career as a lawyer before the *Tribunal* and later he presented his doctoral dissertation on 24 March 1747.<sup>185</sup>



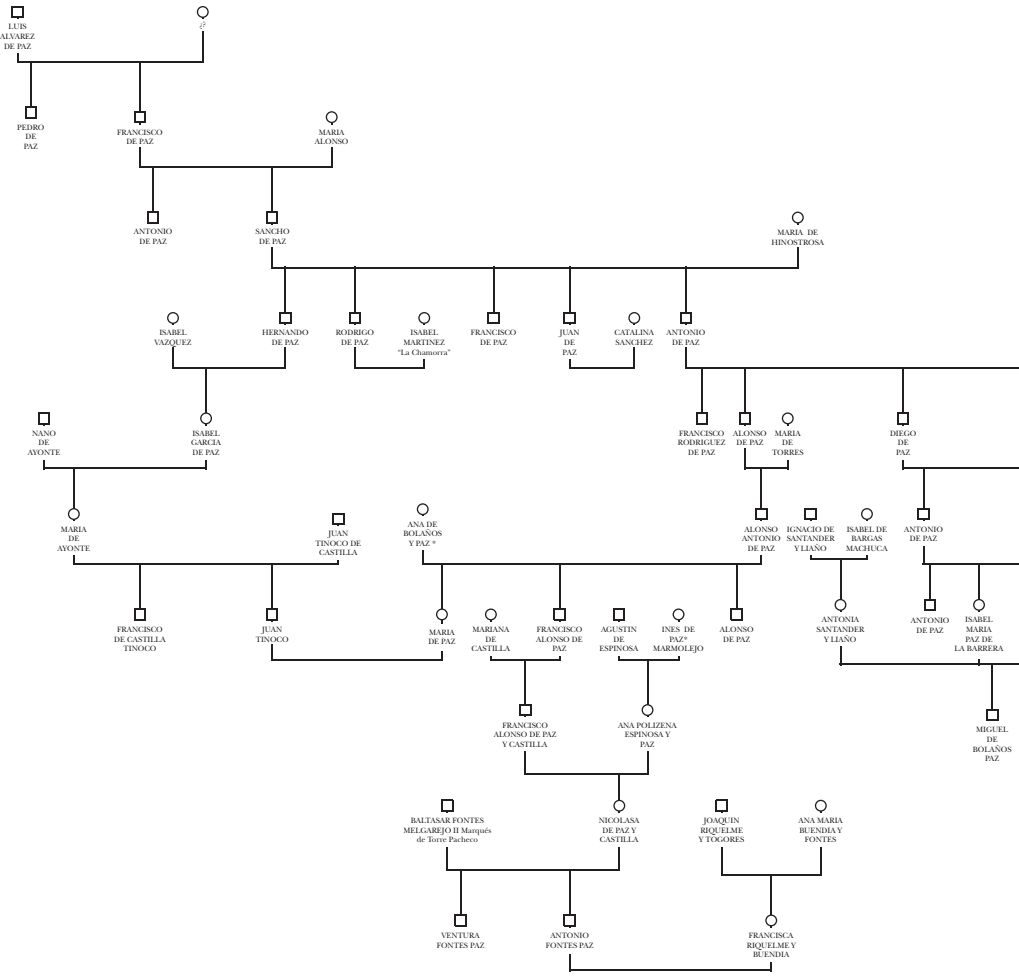

**Figure 2.1** Genealogy of the Paz Family, fifteenth to eighteenth centuries

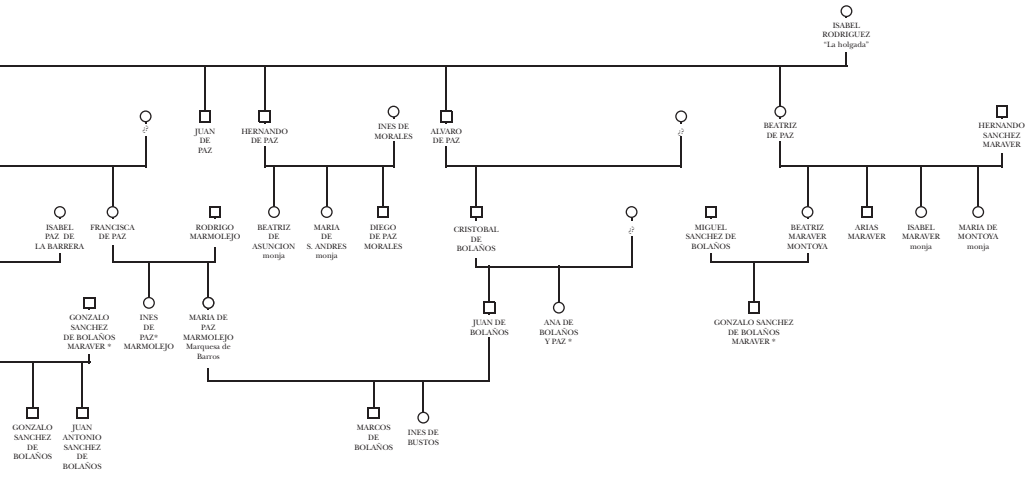

By building a noble genealogy and showing their connection to the most illustrious institutions of the Spanish *ancien régime*, the Riquelme lineage's goal was to erase from collective memory any sign that could link their lineage to a family of Jewish ancestry (see figure 2.1, and appendix pp. 298, 299). A *judeizante* origin could damage the honour and *nobilísima hidalguía* of the lineage. People should not forget the illustrious past of the Riquelme, and with that objective the best strategy was to connect all members of each generation with the most prominent and honourable social groups of the *ancien régime*.

# Building a Social Network through Political, Social and Institutional ties

---

## 3.1. Marriage Strategies to Remain in Power: Family Bonds and Kinship, 1500s–1800s

Marriage is a key moment in the life-cycle: it is the start of a new family.<sup>1</sup> When analysing the oligarchy and those with power in society, marriage is an essential tool to trace strategies and social alliances between elite ruling families. In Mediterranean Europe these groups use marriage to maintain and, if possible, also increase, their social status. Through marriage among families within the same – or higher – social status, the elite also reproduces socially as a family group, thus preventing a depletion of long-standing bloodlines.<sup>2</sup>

Alliances and marriages resulted in a large social network that united individuals from different oligarchic families. In Europe and southern Spain, ties among the individuals were based on solidarity, dependency, clientelism and domination.<sup>3</sup> However, these relationships were far from being ties among equals. In the society of the *ancien régime* in the Spanish monarchy, there was a clear hierarchy even within the same estate, and to protect one's position on the ladder it was important to be linked to families who were higher on it. Domination was not exerted by force; it was achieved through ordinary, commonplace mechanisms inherent in patronage and clientelism – awarding *gracias y mercedes*, assuring protection, doing favours, sponsoring a variety of activities, and looking for integration and understanding. And clearly, violence and coercion to

achieve these ends were used when needed.<sup>4</sup> The relation between Fajardo and Riquelme members, and their protections regarding the *adelantados* in southern Castile in the kingdom of Murcia at the end of the fifteenth century was evidence of how these mechanisms had worked to elevate the lineages in the Murcian urban oligarchy.

Behind the alliance with the Comontes family there were additional religious interests. From the time the relationship began, and all through the early modern period, the Riquelme held important positions in the *cabildo eclesiástico* such as *dignidades*, *canonjías* or *raciones*. In addition, the union with other important noble families in Murcia, especially the Fontes family, was another example of homogamy (marrying equals) to maintain and consolidate their elite social status.<sup>5</sup>

From the top of the social pyramid, a wide and lengthy social network develops and brings together prominent families of the kingdom of Murcia and comes to encompass the social, political and religious power spheres. That was the ultimate goal of the elite, to be part of each of these spaces of power, and marriage among the powerful was indeed the best way to achieve it. This was a very common practice in communities of Mediterranean Europe.<sup>6</sup> The social enclosing of the nobility was thus sociopolitical and economic in nature. Permanently holding the main positions of power, either in the civil sphere and the *cabildo eclesiástico*, and also keeping property and patrimony within the family and through inheritance, were the main elements for the group's social reproduction and plans to stay at the top.<sup>7</sup>

This chapter explains how the Riquelme lineage, beginning in the sixteenth century and through the eighteenth century, perpetuated its presence and dominance through a system of marriage alliances in southern Castile. Generation after generation, in the *ancien régime*, the objective of keeping social groups enclosed remained the oligarchy's most fundamental objective in the Crown of Castile.<sup>8</sup>

### **3.1.1. The Riquelme, Fajardo and Comontes: The Conquest, and Sociopolitical and Religious Power**

Chapters one and two explained how marriage strategies with Fajardo family members and developing clientele relationships with this group increased the Riquelme lineage role in the kingdom

of Murcia's political life. Marriage was the main instrument that oligarch families in the Iberian kingdoms used to maintain and increase a high socioeconomic status, and, in this sense, this section also analyses the key role that women played in socially reproducing a family name and its social goals.

The Riquelme chose to join the Fajardo lineage through one of its collateral lines, through the marital union of Francisco Riquelme and Isabel Gómez Dávalos in the early fifteenth century. Isabel was the daughter of Murcia's *adelantado*, Pedro Gómez Dávalos, the nephew of *adelantado* Alonso Yañez Fajardo and also related to the *condestable* of Castile, Rui López Dávalos, whom Francisco Riquelme had also formerly served. The kinship of Alonso Yañez and Pedro Gómez was almost purely of a political nature.<sup>9</sup>

After this marriage, the Riquelme were fully immersed in the Fajardo sphere of influence, and this took Riquelme family members to the highest positions of sociopolitical power of the kingdom of Murcia and the Crown of Castile. Most importantly, the social role of *patrón-cliente* becomes clear and explicit with this union: there was an implied mutual reciprocity between both names in terms of political, social and family links, though it was also unbalanced between a superior Fajardo and a lower-status Riquelme lineage.<sup>10</sup>

In the mid-fifteenth century, Francisco Riquelme's and Isabel Gómez's first-born son, Alonso Riquelme, married Catalina de Quirós, cousin of the *comendador* of Santiago, Juan Ruíz de Quirós. The couple had three children, Martín, Diego and Luis Riquelme. The marriage allowed the Riquelme to be in contact with illustrious individuals with positions in the Order of Santiago. After Isabel's death, Alonso Riquelme's second marriage was to María Sánchez de Torres, daughter of Juan Sánchez de Torres, one of the sixteen *regidores* of king John II.<sup>11</sup> Slowly, the Riquelme wove a thick network of relationships within the different socioeconomic, religious and political powers, and they fully participated in it and benefited from it. This was a wide practice in Europe during the early modern period and in the transition to the nineteenth century.<sup>12</sup> Marriage was the motor of the lineage's pursuit of relationships with the most prominent families in all areas of power.<sup>13</sup> The generation after put into practice a series of strategies that became regular during the early modern period. These are key to

analysing and understanding the politics of marriage and the lineage strategy between the sixteenth and eighteenth centuries.

Among the Murcian elite, families allied to narrow their political, social, economic and religious ties. The matrimonial unions of Diego Riquelme (first lord of Coy) and Martín Riquelme '*el valeroso*', children of Alonso Riquelme and Catalina Quirós, are a revealing example. They show the typical demographic structure of the alliances between noble families in Mediterranean Europe, which Gérard Delille has thoroughly documented for the Neapolitan case in southern Italy.<sup>14</sup> There were double marriages or '*matrimonios a trueque*', usually joining brother and sister with sister and brother, which also allowed for other combinations and different dates at which the marriages could be arranged.<sup>15</sup> It is worth highlighting the existence of crossed marriages that join siblings of different sex, and the simple or parallel ones, that united two brothers with two sisters (see figures 3.1 and 3.2).

Figure 3.2 shows an example of crossed marriages of siblings of the same sex – Diego Riquelme married Aldonza de Comontes

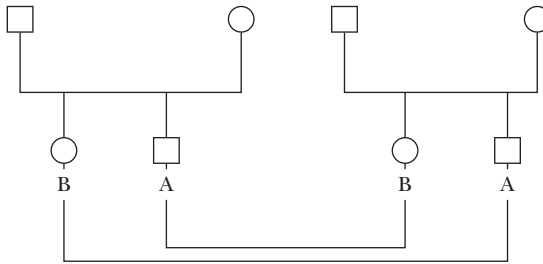

**Figure 3.1** Crossed marriages of siblings of different sex (endogamy)<sup>16</sup>

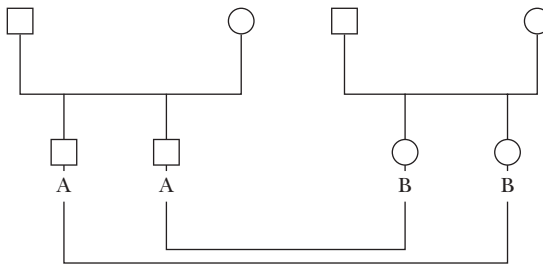

**Figure 3.2** Crossed marriages of siblings of same sex (endogamy)<sup>17</sup>

Vilagomez, and Martín Riquelme married María de Comontes Villagomez in a second marriage at the end of the sixteenth century. Aldonza and María were the daughters of Juan de Comontes de Villagomez and María Ceron, and also nieces of Diego de Comontes, bishop of Cartagena, which allowed the Riquelme to be part of the ecclesiastical elite.<sup>18</sup> The Comontes name, which later in the mid-sixteenth century also linked the Riquelme to the Coque family through the union of Alonso Riquelme de Comontes (second lord of Coy) and Inés Coque, was key to opening positions in the *cabildo catedralicio*. The brothers of Inés, Macías and Luis Coque, already held the positions of *canónigos* and *racioneros* in the cathedral. In addition, they owned large properties that made up the *señorío* of La Nora, all linked through the *mayorazgo* of 1559.<sup>19</sup>

In southern Europe, as for the case of the kingdom of Murcia, exogamous marriages to unite individuals of the same socio-economic status, mainly to diversify and complement economic resources and to increase family landownership, also allowed social homogamy to thrive.<sup>20</sup> When Comontes and Coque joined names – an important line of the Riquelme lineage – the Coque family opened the doors into the religious sphere. It meant access to positions and also new ways to enlarge their landownership through the fusion of the three names in the Riquelme lineage, resulting in the creation of large *mayorazgos*.

In this oligarchic group, and in the Riquelme name in particular, it was common to marry twice. They did this for two reasons: one, to rise in socioeconomic status if one of the partners in the marriage was above the other in social status terms; and second, responding to demographic factors, since the reason for the first marriage often made parties too far apart in age and increased the probability of one widowing early, leaving the family with no successor to continue the lineage.<sup>21</sup>

Three marriages were also registered at times – Martín Riquelme '*el valeroso*' did it at the start of the sixteenth century. Though the reasons for the spousal deaths are unknown, the sources show that Martín was deeply aware of the role that his marriages played in securing the continuation of the lineage. He had participated in the reconquest of Granada and was close to the court of the Catholic monarchs, and these were also favourable factors for important families to establish family links with the Riquelme name.



Through a studied marriage strategy, the Riquelme family built a social network with all the feudal spheres of power of the late medieval period in the Crown of Castile. In doing so, the Riquelme lineage was entrenched in the Murcian oligarchy, which was the starting point of future alliances and family and sociopolitical linkages with the most important names of the kingdom of Murcia's elite. Through Martín's actions, the lineage reached the most elevated strata of power inside various institutions: the court, the military orders, the *concejo*, the bishopric and the Inquisition.

Everything worked in favour of Martín Riquelme. Through three marriages he extended his social network, which helped him consolidate the family group's sociopolitical aspirations, and he also got heirs to assure the continuity of the lineage and the protection of economic patrimony. First, he married Aldonza de Cascales, daughter of Juan Martínez de Cascales, a member of the council for the Catholic monarchs, and Beatriz Alonso (*señora del hábito de Lavanda*), direct cousin of Francisco de Cascales, *maestresala* for the king.<sup>22</sup> This union facilitated the presence and continuity of the family at court.

Second, he married María de Comontes Villagomez, niece of Diego de Comontes, bishop of Cartagena. As mentioned above, his brother Diego Riquelme (first lord of Coy), married María's sister, Aldonza de Comontes Villagomez – a crossed marriage between brothers and sisters – which explains how this union introduced the Riquelme into the heart of the ecclesiastical elite.

Without heirs from the first two marriages, Martín had to marry a third time. The new spouse was Constanza de Barrientos, lady to Isabella the Catholic, daughter of Fernando Barrientos (knight of the *hábito* of Santiago, member of the council for the Catholic monarchs and *corregidor* of Murcia) and of Isabel Vozmediano y

**Table 3.1** The zenith of the Riquelme lineage: Martín Riquelme's (*'el valeroso'*) marriage strategy

= (First marriage) Aldonza de Cascales → court of the Catholic monarchs
= (Second marriage) María de Comontes Villagomez → bishopric of Cartagena
= (Third marriage) Constanza de Barrientos → court of the Catholic monarchs, Order of Santiago, Inquisition and <i>Concejo</i>

Mendoza. She also was the sister of Lope Barrientos, general *inquisidor* of Castile, bishop of Ávila, Segovia and Cuenca, and the niece of the duke of maqueda, marquis of Elche and other great names (*grandes*) of Castile's elite.<sup>23</sup> Through this union the Riquelme tackled the court, the Order of Santiago and the *concejo* of Murcia, which itself was closely linked with the highest position of the kingdom, the *corregidor*. The third marriage opened the door to establishing links with the newly created and powerful Inquisition.

A rigorous strategy of alliances with the prominent names from both civil and ecclesiastical spheres of power placed the Riquelme lineage, by the beginning of the sixteenth century, within each and every one of the powers of feudal origin and civil and religious institutions: the monarchy, the *concejo*, the Inquisition, the military orders and the bishopric.<sup>24</sup> Martín Riquelme's three marriages were clear evidence of this process. There were other key individuals in each generation of the Riquelme lineage as well, and an analysis of their social trajectories and life-cycles is fundamental to understanding and evaluating the larger picture of strategies and behavioural mechanisms of the lineage.<sup>25</sup>

Behind the interests and specific behaviours there were a series of strategies and *modi operandi* that need to be understood more broadly in relation to the group.<sup>26</sup> Each action that an individual takes comes back as a benefit to the entire group. There is a back-and-forth feedback or reciprocity between the individual and the group. Each event influences the social actor and his family context in a particular way, and both sides are always in relation to one another; they both exist as a result of mutual favour and benefit from each other.<sup>27</sup> These practices were very common in Europe and had special emphasis in communities of Mediterranean Europe. It is important to go from the particular to the general or, in other words, the evolution of a family group must be analysed at a small scale but also extending the space and time of inquiry so that it is possible to perceive the continuities and changes of the patterns that the most important lineages experienced between the sixteenth and eighteenth centuries. In the words of Michel Bertrand, '*L'approche micro-historique permet ainsi de souligner la richesse d'identités collectives et individuelles.*'<sup>28</sup> Hence the case of Martín Riquelme is particularly relevant during this period – his alliances are the starting point for the Riquelme becoming one of the most important lineages in the kingdom of Murcia.

**Table 3.2** Riquelme family civil and ecclesiastical powers

Riquelme family	⇒ Political sphere	→ <i>Alcaidías</i> (14th–15th c) → <i>Lugartenencias</i> in the <i>Adelantamiento</i> (14th–15th c) → <i>Regidurías</i> (15th–16th c)
	⇒ Religious sphere	→ bishopric of Cartagena ( <i>prebendas</i> 16th–17th c) → Order of Santiago ( <i>hábitos</i> , 15th–17th c)
	⇒ Economic sphere	→ Enlarged patrimony → Creation of <i>Mayorazgos</i> (16th c – 17th c)

By the start of the sixteenth century, the marriage alliances were already promoting members of the Riquelme family into important civil and ecclesiastical positions. They were building a tight family network, tying both the political (with positions in the *concejo* of Murcia) and the religious (some members were *arcedianos*, *canónigos* or *racioneros*) spheres, making group and family interests dominate over that of the individual.<sup>29</sup>

Chapter four explains, in detail, how the Riquelme family built an extensive patrimony by founding *mayorazgos*, and how, as a result, it became one of the most important landowning families in the kingdom of Murcia. So, added to the sociopolitical and

**Table 3.3** Clergy members (prebendary) of the Riquelme lineage at the cathedral of Murcia<sup>30</sup>

Social actor	<i>Prebenda</i>	Start date of <i>prebenda</i>
Luis Coque	<i>Canónigo</i> and <i>arcediano</i>	1559 <sup>31</sup>
Macías Coque	<i>Canónigo</i> and <i>arcediano</i>	1559
Esteban Guil Riquelme	<i>Arcediano</i>	1606
Bernardino Fontes de Albornoz y Riquelme	<i>Canónigo</i>	1643
Diego Riquelme Quirós	<i>Canónigo Magistral</i>	1659



over time. In addition, the Fajardo had important economic interests that went along with these unions – both sides benefited from the increasing accumulation and combination of each of the families' properties. For example, Juan Fajardo and Salvadora Riquelme's first-born, Alonso Fajardo, was also lord of the Palomar.

Thus, it was at the start of the sixteenth century, at the end of the reconquest, that the Riquelme family began to establish its socio-economic power and to make important family ties, especially with the oligarchic, powerful and already entrenched Murcian Fajardo lineage. This connection was the starting point for the family's patrimony to continue to grow through marriages and relationships, at this time mostly of exogamic character, with families from the elite in Murcia such as Avilés, Pagán, Fontes de Albornoz, Fontes Carrillo, Melgarejo, Peraleja, Bernal, Verástegui and Bienvenida.<sup>34</sup> Through them, the Riquelme reached important spheres of power. This was the genesis of the Murcian oligarchy, which grew to become a closed group concentrating more and more power for future generations.

### 3.1.2. Riquelme and Fontes: Consolidation in the Oligarchy

The concepts of family, lineage, and marriage alliances were deeply entrenched in the social mechanisms and strategies that the Riquelme lineage pursued, beginning in the late fifteenth century, and especially at the end of the eighteenth century. In southern Europe the family was at the centre of a society where social relations were based on consanguinity between directly related individuals, but also based on filiation in a fictitious sense – non-consanguinity-related individuals who instead had strong links based on loyalty, patronage and solidarity.<sup>35</sup>

The inheritance system in place, structured through primogeniture, also fundamentally shaped the relations between families in the oligarchy. The family patrimony accumulated following an *agnaticia* (agnatic) line, prioritising male figures in the family, so that property did not disperse through collateral branches of the lineage.<sup>36</sup> The institution of the *mayorazgo* in the Iberian kingdoms served as the main tool to achieve this goal as well.

The lineage served to reference having a common ancestor from whom the entire family descended.<sup>37</sup> This figure had settled in the kingdom in the time of the reconquest after achieving glorious acts and deeds, which in turn provided the name/lineage with

honour and prestige. The descendants were from then on able to claim and be proud of being *cristianos viejos*.

The lineage marked how to move strategies and alliances with families in the oligarchy following a twofold purpose: first, so that the main line of the lineage remained, and second, to avoid the dispersal of the family patrimony, which stayed in the hands of the first-born son through the *mayorazgo*. The Riquelme-Fontes alliance was the perfect example of this model. After gaining prestige at the end of the reconquest and through the sixteenth century, the way for the Riquelme to solidify their position was by combining forces with another lineage at a similar level. Through the generations, both lineages established continuous alliances. As figure 3.4 shows, at times, the families had to wait two or three generations to be able to unite again. The 1215 Lateran Council (*Concilio de Letrán*) prohibited marriages within four grades of consanguinity in Catholic Europe.<sup>38</sup> However, both lineages elided this limitation by applying for a *dispensa apostólica* (apostolic exemption). Once they reached the fourth degree, the Riquelme and the Fontes family united again to avoid dispersing their patrimony, practising what is called a marriage turn or *bucle matrimonial*.<sup>39</sup>

The Riquelme-Fontes unions allow us to trace the social network of both families in a context of regrouping, reproduction and social enclosing of the oldest nobility lineages of the Murcian oligarchy. Not without friction about inheritance, the connection introduced the Riquelme family into the group of prestigious names that helped the lineage attain a significant economic family patrimony.

The supposedly Castilian equal inheritance system, which ended up favouring the first-born by using the *mayorazgo*, is what made

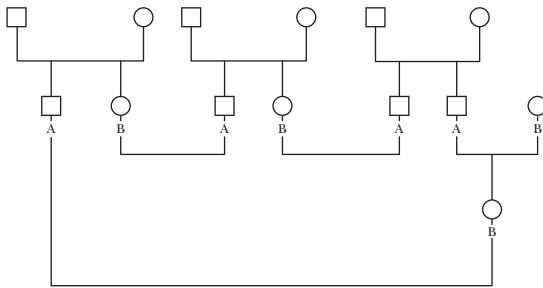

Figure 3.4 Endogamic unions through marriage turn

families pursue endogamy more frequently. The *mayorazgo* avoided the dispersal of the patrimony from a system based on the division of inheritance. In addition, it allowed families to create a new patrimony.<sup>40</sup> Marriages between uncles and nieces (or aunts and nephews), and between two brothers and two sisters, were especially useful and meaningful in creating these kinds of kinship relationships and communities in Mediterranean Europe, mainly in southern France, Italy and Spain. And the Riquelme-Fontes example is a relevant case of such a practice. A range of family names unite through a chain of alliances that becomes the ideal strategy to maintain a system of equal division of inheritance only among territorially localised relationships.<sup>41</sup>

The first alliance of the Riquelme-Fontes occurred during the first third of the sixteenth century with the marriage of Macías Coque Riquelme and Constanza de Avilés y Fontes. Macías Coque was the head of the Riquelme lineage who led the group against other factions in the frequent conflicts of the time.<sup>42</sup>

From then on, during the second half of the sixteenth century, short cycles of one or two generations of unions between Riquelme-Fontes or Fontes-Riquelme occurred, when surnames weave and create a subtle game of marriage alliances (see the complete genealogy of the two lineages in chapter two). The ultimate goal is to avoid requesting a *dispensa* (exemption) – families in Catholic Europe waited to the fourth and fifth grades of consanguinity, not vetoed by the Vatican, to unite again – to keep the patrimony together and not lose the family name of the lineage. Social homogamy and endogamy thus became a pattern of Spanish elite society.

Such social mechanisms are an attempt to find the middle ground between kinship and social considerations. The *dispensas* that the Church provided were a clear expression of the importance of endogamy in marriage practices that saw family relationships as key to consolidate or defend acquisitions.<sup>43</sup> The common denominator of all these alliances was the number of marriages within a family as a close group which avoided loss of patrimony. In the case of the Riquelme-Fontes, as they put into practice such marriage strategies, there were limited consanguineal marriages – three in the sixteenth century, and a fourth in the eighteenth century.

By practising *bucle matrimonial*, by waiting several generations to unite, in fourth grade of consanguinity but only between related family members, and avoiding the canonical prohibition, the

**Table 3.4** Consanguineal marriages between Riquelme-Fontes<sup>44</sup>

Intending spouses	Consanguineal level	Marriage date
Cristóbal Riquelme de Arroniz (third lord of Santo Ángel) = Nofra Riquelme de Albornoz		First third, sixteenth century
Cristóbal Riquelme de Comontes (fourth lord of Coy) = Antonia de Arroniz Riquelme	Uncle–niece	Second half, sixteenth century
Baltasar Fontes Riquelme = Petronila Riquelme de Avilés	Aunt–nephew	Last third, sixteenth century
Jesualdo Riquelme y Fontes = María Concepción Fontes y Riquelme	Uncle–niece	Second half, eighteenth century

Riquelme-Fontes unions reveal a strategy. The ultimate goal is to maintain the biological line, the main branch of the lineage, thus avoiding the loss of the surname and the family patrimony. Evidence of this was the marriage between Cristóbal Riquelme de Arroniz (third lord of Santo Ángel) and Nofra Riquelme, who were related by blood, in the early sixteenth century.<sup>45</sup> The spouses created a *mayorazgo* in 1544 to join together, in one unit, their multiple properties.<sup>46</sup>

The next marriage between blood-related spouses, that of Cristóbal Riquelme de Comontes (fourth lord of Coy) and Antonia de Arroniz Riquelme (uncle and niece), happened in the second half of the sixteenth century.<sup>47</sup> This union was important because it joined two main sections of the Riquelme lineage, both descendants of Guillén Riquelme's lines in Campo Coy and Santo Ángel. Both patrimonies came together through their first-born son, Cristóbal Riquelme y Arroniz, who became lord of Coy and fourth lord of Santo Ángel. In addition, this marriage was also the genesis of the core stem of the Riquelme lineage.

Of equal relevance was the late sixteenth-century union between Petronila Riquelme de Avilés, the daughter of Macías Coque Riquelme and Constanza de Avilés y Fontes, with Baltasar Fontes Riquelme, son of Nofre Fontes de Albornoz y Avilés and Isabel Pagán Riquelme.<sup>48</sup> On the one hand, two blood-related individuals



married – Baltasar was Petronila’s nephew – and on the other hand, after Isabel Pagán Riquelme and Nofre Fontes de Albornoz y Avilés’s marriage on 13 March 1593, the patrimonies were linked through the creation of a *mayorazgo* that was later transferred to the first-born son, Baltasar Fontes.<sup>49</sup> Worth remembering here is that the female heir of Macías Coque Riquelme’s link was his daughter Petronila. The achievement at this point was the strengthening of the family’s name through the *cognaticia* line, since the marriage between Macías Coque Riquelme and Constanza de Avilés y Fontes had no legitimate male descendants (see the complete Riquelme genealogy tree, thirteenth to eighteenth century, figure 4.26).

So, in less than two generations, two marriages between Riquelme-Fontes members were celebrated. Thus the *bucle matrimonial* is again put into practice to integrate patrimony and properties linked to Macías Fontes Riquelme – first-born of Baltasar and Petronila, baptised on 26 October 1601 – both from his paternal and maternal grandparents.<sup>50</sup> This case also exemplifies the key role that women played in the social perpetuation and reproduction of the lineage in Mediterranean Europe and southern Castile.

It was not until the second half of the eighteenth century, however, when the next marriage between blood-related individuals, and a *bucle matrimonial*, was again registered.<sup>51</sup> Jesualdo Riquelme y Fontes (lord of Guadalupe) and María de la Concepción Fontes Riquelme, uncle and niece, married to avoid the dispersal of their patrimony. Such a social mechanism helps the kinship line to maintain the patrimony in one line of succession – Jesualdo Riquelme was the immediate successor of his father’s *mayorazgo* as the only male child of Joaquín Riquelme y Togores.<sup>52</sup> In this case as well, a transversal cut occurred, as they skipped one generation.

After the union of Petronila Riquelme and Baltasar Fontes, it was not until the great-grandson Pedro Fontes married Juana Riquelme Cervellón (baptised on 22 March 1591 in the parish of San Lorenzo) that the *bucle* could be repeated once more.<sup>53</sup> A long cycle of time intervened in order to avoid the need for a canonical exception.<sup>54</sup> Similarly, the 1749 marriage of Antonio Fontes Ortega Carrillo y Zambrana with Luisa Robles Serrano y Molina resulted in a region-wide connection of inheritances, titles and links. Luisa and Antonio’s marriage linked regions in southern Spain, Andalucía, central Spain, La Mancha and Murcia.<sup>55</sup> Luisa had ties with Hoya-Morena, Tobarra, Las Montañas, Nazaret and San Clemente de la Mancha in the south

(in places like Baza, Iznalloz, Alcalá la Real, Llíobrega, Puebla de Don Fadrique, Hurdienca, San Miguel and Corvera) as daughter of the first marriage of Joaquín Riquelme y Togores, which also meant that she was part of the main line of the Riquelme lineage through the Robles-Serrano name. Antonio was similarly well connected as *regidor* of Murcia, founding father of the *Real Sociedad Económica de Amigos del País* in that city, as heir to the *mayorazgo* (founded 15 September 1542) of the *comendador* Pedro Zambrana and his spouse Ginesa Corella, as well as the *vínculo* (founded 2 July 1731) that his father Antonio Fontes Carrillo Bienvenud y Arce created in 1731 after the death of his older brother Rodrigo Fontes Ortega from mental health troubles.<sup>56</sup>

In the Iberian kingdoms throughout the eighteenth century, especially during the second half, the social enclosing and narrowing of the Riquelme-Fontes lineage was most evident when the combining of patrimony through *mayorazgos* occurred to avoid dispersal among collateral sides of the lineage.

Within this context consanguine marriages took place in Mediterranean Europe, skipping one generation or two, but also allocating, in a strategic way, the main *mayorazgos* in the hands of key members of the lineage and marrying twice or even three times to achieve both social and economic goals.<sup>57</sup> Such was the case of Luisa's father, Joaquín Riquelme y Togores (who died at the end of the eighteenth century), who married three times: first, Manuela de Robles y Molina; second, Luisa's mother, Ana María Buendía y Fontes, with whom he had another legitimate daughter, Francisca Riquelme y Buendía; and third, Antonia Fontes Paz. Jesualdo Riquelme y Fontes was the legitimate son of this last marriage with Antonia.<sup>58</sup> The Riquelme-Fontes alliance comes out strongly after these marriages as a social group and also because of the centralisation of patrimony under one name.

The union that took place in the parish of San Nicolás (Murcia) in 1753 between Antonio Fontes Paz (third marquis of Torre Pacheco, baptised 7 November 1730 in the parish of San Bartolomé) and Francisca Riquelme y Buendía (baptised seven years later in the same location) is central to understanding the importance of the Riquelme-Fontes alliance of the eighteenth century.<sup>59</sup> It gave the Riquelme lineage the way to connect with the house of Fontes-Pacheco (its name comes from the marquise of Torre Pacheco), which in turn connected the Riquelme family with the Fontes lineage and, most importantly, with the Paz name, which was well

connected in the court in Madrid. As chapter four shows, this is what gave Antonio Fontes Paz an impressively large patrimony based on *vinculaciones* and *mayorazgos*. In 1788 he married Isabel Rodríguez de Navarra Mergelina from Villena, the daughter of Alonso Rodríguez de Navarra y Mergelina and Juliana Mergelina.<sup>60</sup> The link with the Rodríguez Mergelina family helped to broaden the socioeconomic importance of the lineage beyond Murcia's outskirts, specifically in the old marquisate of Villena.

Both of Jesualdo Riquelme's weddings are part of all this step-by-step process. In 1776, his marriage to Isabel María Abad y Ulloa, originally from Villahermosa (Ciudad Real), was ratified in the parish of San Nicolás in the city of Murcia.<sup>61</sup> Isabel María was Felipa Abad y Ulloa's sister, the spouse of Francisco de Borja Fontes y Riquelme, nephew of Jesualdo Riquelme, thus maintaining the same strategy explained before of joining illustrious families located outside the kingdom of Murcia. In this case it was the family name Abad. Felipa and Isabel were the daughters of Sancho José Abad y Sandoval (born in Villahermosa, *alcalde ordinario* of the *villa* of Beas and knight of Calatrava since 1700), and Ana María de Ulloa y Olmedilla.<sup>62</sup>

María Ignacia Riquelme y Abad was Jesualdo and Isabel María's only daughter, and when Isabel María died at the end of the eighteenth century, Jesualdo married his direct niece, María Concepción Fontes y Riquelme, and had a son, Antonio Riquelme y Fontes.<sup>63</sup> The link with the Abad family is an example of the reaches of the family as it expands horizontally by enlarging the family group through non-consanguine unions (marriages that take place among people who do not share blood ties, bonds of an exogamous nature). But endogamy, or consanguine marriage, was also common, which served to reaffirm the vertical line around the *jefe-patrón* (*ego*) and thus the power and hegemony of the lineage and the centralisation of property through one heir only. Jesualdo Riquelme y Fontes became the *jefe-patrón* and representative of the main line of the lineage as first-born son of Joaquín Riquelme y Togores and heir of the *mayorazgos*.

The overall result of these strategies was the absolute closeness of the vertical kinship, which helped to avoid the dispersal of the family patrimony by keeping the name of the lineage attached to landownership. A possible outcome could also have been the biological stagnation and disappearance of the lineage by the start of the nineteenth century as a result of the tightness enforced through the marriage alliances between the Fontes and Riquelme families. This

**Table 3.5** Double marriages in the Riquelme lineage<sup>64</sup>

Intending spouses	Kinship	Date
Diego Riquelme (first lord of Coy) = Aldonza Villagomez de Comontes  Martín Riquelme ' <i>el valeroso</i> ' = María Villagomez de Comontes	two brothers / two sisters	Early sixteenth century
Salvadora Riquelme = Juan Fajardo  Lorenzo Riquelme de Barrientos = Isabel Fajardo	two direct cousins / two sisters	First half, sixteenth century
Nofre Riquelme de Arroniz (fourth lord of Santo Ángel) = Blanca de Avilés  Macías Coque Riquelme = Constanza de Avilés y Fontes	two related family members in 4th consanguineal grade / two sisters	First half, sixteenth century
Diego Riquelme de Comontes = Luisa Fontes de Albornoz y Guevara  Fadrique Riquelme de Comontes = Juana de Albornoz y Guevara  Aldonza Riquelme = Francisco Galtero	two brothers / two sisters  Aldonza → Diego and Fadrique's sister	First marriage: late sixteenth century  Second and third marriage: 16 February 1605 in San Bartolomé (Murcia)
Baltasar Fontes y Avilés = Isabel Francisca Carrillo y Marín  Antonio Fontes Riquelme = Claudia Carrillo Marín	two third cousins / two sisters	First marriage: 10 February 1654 in San Bartolomé (Murcia)  Second marriage: 29 March 1649 in San Bartolomé (Murcia)

**Table 3.5** Double marriages in the Riquelme lineage<sup>64</sup> (*Continued*)

<b>Intending spouses</b>	<b>Kinship</b>	<b>Date</b>
Macías Fontes Carrillo (first marquis of Torre Pacheco) = Ana Ceferina Melgarejo Galtero  Catalina Fontes Carrillo = Francisco Melgarejo y Galtero (count of Valle de San Juan)	Brother-sister / sister-brother	First marriage: 16 February 1670 in San Bartolomé (Murcia)  Second marriage: 25 September 1667 in San Bartolomé (Murcia)
Antonio Fontes Paz = Francisca Riquelme y Buendía  Joaquín Riquelme y Togores = Antonia Fontes Paz	Brother-sister / Father- daughter	First marriage: 27 July 1753 in San Nicolás (Murcia)  Second marriage: second half of the eighteenth century.
Joaquín Fontes Riquelme = María de los Dolores Fernández de la Reguera y Sancho  Segunda Fontes Riquelme = Juan José Fernández de la Reguera y Sancho	Brother-sister / sister-brother	First marriage: last third of the eighteenth century.  Second marriage: last third of the eighteenth century
Jesualdo Riquelme y Fontes = Isabel María Abad y Ulloa  Francisco de Borja Fontes y Riquelme = Felipa Abad y Ulloa	Uncle-nephew / sister-sister	First marriage: 16 January 1776 in San Nicolás (Murcia)  Second marriage: 10 January 1771 in San Miguel (Murcia)

Table 3.6 Marrying age<sup>65</sup>

Spouses	Husband's baptism	Wife's baptism	Husband's marrying age	Wife's marrying age	Age difference between spouses
Macías Fontes Riquelme = Catalina de Avilés y Fajardo (Cp.m. 8 September 1624, San Miguel, Murcia) <sup>66</sup>	26 October 1601, San Bartolomé (Murcia)	22 January 1601, San Miguel (Murcia)	23 years old	23 years old	0 years
María Riquelme de Arroniz = Juan Pedro Muñoz de Robles (Cp.m. 1621)	16 November 1594, Caravaca	6 December 1599, Colegial de Lorca	22 years old	27 years old	5 years
Dionisia de Paula Galtero Peraleja = Diego Melgarejo de Mora (Cp.m. 7 May 1635, San Bartolomé, Murcia)		27 January 1621, San Bartolomé (Murcia)		14 years old	
Antonio Fontes Riquelme = Claudia Carrillo Marín (Cp.m. 29 March 1649)	5 January 1621		28 years old		
Baltasar Fontes y Avilés = Isabel Carrillo Marín (Cp.m. 10 February 1654, San Bartolomé, Murcia)	29 July 1627		27 years old		

Table 3.6 Marrying age<sup>65</sup> (Continued)

Spouses	Husband's baptism	Wife's baptism	Husband's marrying age	Wife's marrying age	Age difference between spouses
Antonia Muñoz de Robles Riquelme = Ignacio Salafrañca (Cp.m. 11 February 1654, Caravaca)		8 January 1629, Caravaca	25 years old		
Macías Fontes Carrillo (first marquis of Torre Pacheco) = Ana Ceferina Melgarejo y Galtero (Cp.m. 16 February 1670)	28 January 1648, San Bartolomé (Murcia)	5 November 1648, San Bartolomé (Murcia)	30 years old	30 years old	0 years
Pedro Fontes Carrillo = Luisa Bienvenud Ladrón de Guevara (Cp.m. 1 November 1684, San Miguel, Murcia)	20 March 1655, Cathedral (Murcia)	26 April 1670, Nuestra Señora de la Asunción (Tobarra)	29 years old	14 years old	15 years
Baltasar Fontes Melgarejo (second marquis of Torre Pacheco) = Nicolasa de Paz y Castilla (Cp.m. 8 October 1702, San Sebastián, villa and court of Madrid)	14 March 1675, San Bartolomé (Murcia)	24 January 1688, Santa Catalina (Frejenal de la Sierra)	27 years old	14 years old	13 years

Table 3.6 Marrying age<sup>65</sup> (Continued)

Spouses	Husband's baptism	Wife's baptism	Husband's marrying age	Wife's marrying age	Age difference between spouses
Francisco de Paula Robles y Riquelme = Isabel de Togores y Robles (Cp.m. 1 October 1709, church of Santiago, Lorca)	20 December 1691, San Bartolomé (Murcia)		18 years old		
José Caro y Roca (marquis of la Romana) = Patricia Fontes Bienengud (Cp.m. 2 October 1710, San Miguel, Murcia)	5 August 1690, Santa María (Elche)	27 May 1691, San Miguel (Murcia)	20 years old	21 years old	1 year
María Gerónima Ortega y Zambrana = (first marriage) José Rocafull Puxmarín y Fajardo (Cp.m. 12 April 1718)		2 February 1691		27 years old	



Table 3.6 Marrying age<sup>65</sup> (Continued)

Spouses	Husband's baptism	Wife's baptism	Husband's marrying age	Wife's marrying age	Age difference between spouses
María Gerónima Ortega y Zambrana = (second marriage) Antonio Fontes Bienvenida y Carrillo de Albornoz (Cp.m. 17 March 1723)	5 October 1686	2 February 1691	37 years old	32 years old	5 years
María Gerónima Ortega y Zambrana = (third marriage) Juan de Sandoval y Lisón (Cp.m. ?)		2 February 1691			
Antonio Fontes Paz (third marriage of Torre Pacheco) = (first marriage) Francisca Riquelme y Buendía (27 July 1753, San Nicolás, Murcia)	7 November 1730, Santa María (Murcia)	9 October 1737, San Bartolomé (Murcia)	23 years old	16 years old	7 years

Table 3.6 Marrying age<sup>65</sup> (Continued)

Spouses	Husband's baptism	Wife's baptism	Husband's marrying age	Wife's marrying age	Age difference between spouses
Antonio Fontes Paz (third marquis of Torre Pacheco) = (second marriage) Isabel Rodriguez de Navarra y Mergelina (Cp.m. 1788)	7 November 1730, San Bartolomé (Murcia)	1761	58 years old	27 years old	31 years
Antonio Fontes Ortega = Luisa Riquelme Robles Serrano (Cp.m. 13 June 1749, San Nicolás, Murcia)	27 May 1725, San Miguel (Murcia)		24 years old		
Francisco de Borja Fontes y Riquelme = Felipa María Abad y Ulloa (Cp.m. 10 January 1771, San Miguel, Murcia)	1753		17 years old		

possibility offers to throw light on understanding why the oligarchy changed strategies as the *ancien régime* was coming to an end.

### **3.1.3. Marriage and Patrimony. An Approach to the Family Group Economy: The Dowry**

The dowry and the *arras* (bride price) were what the spouses contributed when they married, as a way to augment the economic and social capital of the family group. Though the sources in this regard are dispersed and fragmented, there is enough evidence to demonstrate that the value of the dowry and the *arras* (or the goods that the groom brought to the wedding) when marrying were of great importance – these confirmed that in Catholic Europe the family's structure and the system of inheritance were intimately related in only one marriage-patrimony concept.<sup>67</sup>

More than a union between two people, in pre-industrial societies, marriage was a union between two families. Social mobility can be understood through the analysis and quantification of the dowry and the *arras* as well. The dowry was made of both tangible property and landownership, and it was provided to the daughter through paternal and maternal inheritance to become her economic contribution to marriage.<sup>68</sup>

Among oligarchic families, it was common to avoid giving lands to daughters since this hindered social and economic reproduction. Often wealthy families chose convent life for their daughters to concentrate the patrimony in the first-born son through *mayorazgo*. Another option was to enhance the dowry of a daughter sufficiently to marry her to someone of equal or higher socioeconomic status. There were several women from the Riquelme-Fontes lineage who began to wear the *hábito* in the convents of San Antonio, the Carmelitas Descalzas convent, and the convent in Santa Clara la Real among others.<sup>69</sup> There is only evidence for one nun having a dowry: it was Sister Teresa Fontes Pérez de Merlos (the daughter of Macías Fontes Carrillo, first marquis of Torre Pacheco, and of Josefa Mariana Pérez Evia de Merlos) for over 1,000 *ducados*. The dowry was an important indicator of status and a symbol of social prestige.<sup>70</sup>

The *arras* was the property and economic contribution that the husband brought into a marriage. Its origins are in ancient Europe's Germanic societies.<sup>71</sup> The dowry was usually of higher value (see table 3.7), evidence of the crucial role that women played

Table 3.7 The dowry and *arras* of the Riquelme-Fontes family, fifteenth to eighteenth century<sup>72</sup>

Spouses	Dowry	Arras	Date
Martín Riquelme 'el <i>valeroso</i> ' = Aldonza de Cascales		Henry IV gave his father (Alonso Riquelme) 50,000 <i>maravedíes</i> for his marriage.	Second half fifteenth century
Cristóbal Riquelme de Comontes (fourth lord of Coy) = Antonia de Arroniz Riquelme	Main houses in the parish of San Bartolomé; other houses. 1,200 <i>ducados</i> ; inheritances of lands ( <i>morenals</i> ) with houses near Molina; inheritances of lands ( <i>morenals</i> ) with houses in Pago de Benicomay (70 <i>tahúllas</i> ). 4 <i>tahúllas</i> of <i>morenas</i> on the road to Alcantarilla. Another section of <i>morenals</i> ; inheritances of lands of <i>pan llevar</i> and <i>morenas</i> plants with houses. Received from her father (Diego Riquelme de Comontes) 4,000 <i>ducados</i> . With 3,000 of these they bought a <i>regidor</i> position for Cristóbal Riquelme	1 inheritance of vineyards; <i>tierra blanca</i> trees with houses in irrigated fields in Lorca, 1 <i>morenal</i> of 7 <i>tahúllas</i> in the Pago de Alfande	Second half, sixteenth century

Table 3.7 The dowry and *arras* of the Riquelme-Fontes family, fifteenth to eighteenth century<sup>72</sup> (Continued)

Spouses	Dowry	Arras	Date
Gonzalo Rodríguez de Avilés = Isabel Fontes		His parents' (Diego Riquelme de Avilés and Constanza de Bernal) <i>mayorazgo</i> : main houses in Murcia (San Bartolomé); 1 inheritance of irrigated lands in Pago de Alfandarán; 1 <i>pieza</i> in Santomera	2 February 1538
Isabel Rocamora = Pedro Carrillo	3,000 <i>ducados</i>		1629
Macías Fontes Carrillo (first marquis of Torre Pacheco) = Ana Melgarejo y Galtero	7,000 <i>ducados</i>		18 July 1675
Juan José Fernández de la Reguera y Sancho = Segunda Fontes Riquelme	5,000 <i>ducados</i>		1 January 1788

Table 3.7 The dowry and *arras* of the Riquelme-Fontes family, fifteenth to eighteenth century<sup>72</sup> (Continued)

Spouses	Dowry	Arras	Date
Bernardo Riquelme Salafranca y Rocha (first marquis of Pinares) = María de los Remedios Fontes y Riquelme	1 pack of diamonds and emeralds valued at 18,000 <i>reales</i> ; 55,000 <i>reales</i>		20 January 1788
Antonio Fontes Paz (third marquis of Torre Pacheco) = Isabel María Rodríguez de Navarra y Mergelina	33,000 <i>reales</i>		24 May 1788
Antonio Fontes Ortega y Zabrana = Luisa Riquelme y Robles	20,698 <i>reales</i>		14 March 1751

Table 3.7 The dowry and *arras* of the Riquelme-Fontes family, fifteenth to eighteenth century<sup>72</sup> (Continued)

Spouses	Dowry	Arras	Date
Francisco Riquelme Robles = María Irene Galtero	<i>Maynrazgos</i> lands, other properties, <i>semoventes</i> , clothes	1 cabin of mules <i>romas</i> , goods, clothing, <i>alhajas</i> , cash, cavalry	22 February 1762
Antonio Riquelme y Fontes = Josefa Arce y Flores	50,000 <i>reales</i>		First third, nineteenth century
Rafael de Bustos y Castilla (marquis of Corvera) = María Teresa Riquelme y Arce	88,000 <i>reales</i> (=8,000 <i>ducados</i> )		5 October 1843

Table 3.8 Riquelme-Fontes nuns<sup>73</sup>

<b>Nun</b>	<b>Parents</b>	<b>Convent</b>	<b>Entry date</b>	<b>Dowry</b>
<i>Sor</i> Isabel Coque Riquelme	Macías Coque Riquelme = Constanza de Avilés Fontes	San Antonio	Early sixteenth century	
Beatriz de la Peraleja	Martín de la Perpleja = Jerónima Tomás	San Antonio	Early seventeenth century	100 <i>reales</i> annually of orange tree production
<i>Sor</i> Isabel Fontes Ortega	María Gerónima Zambrana y Guerrero = Antonio Fontes Bienengud Carrillo de Albornoz		Mid-eighteenth century	
<i>Sor</i> Asunción Avellaneda y Fontes	Manuela Fontes Paz = José Avellaneda	Carmelitas Descalzas	24 March 1751	
<i>Sor</i> Teresa Fontes Pérez de Merlos († November 1716)	Macías Fontes Carrillo (first marquis of Torre Pacheco) = Josefa Mariana Pérez Evia de Merlos	Santa Clara la Real	Taking vows, 28 December 1704. <i>Profesa</i> 18 April 1706	1,000 <i>ducados</i>



in the marriages of spouses of high social prestige. The *arras* were commonly cash, though the husband sometimes also brought other goods such as *alhajas* (jewellery), clothing, and also land property or houses. *Arras* were, with some exceptions like the case of Martín Riquelme '*el valeroso*', who contributed money, mostly fertile lands and houses.

### **3.2. Development of Social Network and Life-cycle: A Micro-historic Analysis**

Historians have not clearly used the concept of social network analysis and it is a controversial one among scholars.<sup>74</sup> Since it is a concept from sociology, and has its roots in network analysis theories of the early twentieth century, historians, and especially early modern scholars, are wary of its validity.<sup>75</sup> The scarcity and fragmented nature of the sources for understanding the social network of specific individuals has also generated debate among historians.

Most of the studies about the concept are in-depth epistemological discussions about the idea and not so much about the actual network created and the social actors involved in it. In other words, it is important to give first names and surnames to these actors and identify why they were related to each other, and based on their social status, what were the links, the strategies and the social mechanisms that united them and their environment? Only a few studies that analyse the Castilian nobility's commerce networks and spheres of political influence in the nineteenth century have made use of this concept to analyse social relations.<sup>76</sup>

To see how *ancien régime* elites in early modern Europe created a social network, the following analysis focuses on the relations between the powerful and those who depended on them – it is key to understanding how space and sociopolitical and economic power were divided and vertically structured. This section explores the complex context by analysing patronage and clientele relations. In such a hierarchised and unbalanced society, consanguine (family-based) and non-consanguine (related family or *allegados*) relations defined the entire social fabric. In this case, it was the Murcian elite in the Crown of Castile. The group and clientele features have to be at the centre of our understanding of social and political actors in the *ancien régime* and beyond.

The individual as a social actor and his/her social trajectory are central to reconstructing social networks. As far as possible, it is important to track each of the actions of an individual's life-cycle – each of the main moments that an individual goes through in life, such as baptism, marriage and death. In *ancien régime* societies of both Protestant and Catholic Europe, all of these life milestones were related to and based upon the group's interest.<sup>77</sup> As opposed to macro studies, microhistory is the ideal framework to make one-to-one relationships the main focus to study groups and broader concepts. A local perspective is key while studying global socioeconomic processes. Microhistory demonstrates that both local and global scales complement each other, giving historians perspectives and making their analysis permanently aware of socioeconomic, political and cultural changes at either level.<sup>78</sup>

Studying the milieu or social environment where individuals evolve in the case of the Murcian oligarchy in a typical Mediterranean community, and particularly the Riquelme family, allows for a close look at the group's relational capital. Exploring how individuals at the same socioeconomic, and also from different social levels, relate to each other brings out the strategies used to define a group within the elite and how the group maintained or increased its social status.

To tackle this, it is crucial to reconstruct the individual socially through kinship and by examining the alliances that developed through marriage strategies. Ideas around sociability, patronage and clientelism emerge in these strategies. In other words, baptismal and marriage documentation, where a priest, the godparents and the witnesses are present and are not chosen randomly, is what can take the researcher through the kinship links that elite families forged. Marriage is a fundamental mechanism that oligarchic families such as the Riquelme used to connect with other prestigious names and create a social group that sought to close up in itself. Social capital – status and prestige are intangible contributions from families – is generated in marriage and other mechanisms, and over time combines with economic capital – also through families, and specially through the creation of *mayorazgos*. Parish documents are pivotal in examining the Riquelme's social network, as well as wills that mention witnesses, and other sources like protocol files and purity of blood records.<sup>79</sup>

Exploring the diverse sociability spaces of the Murcian elite is also a crucial method when reconstructing social networks of the Crown of Castile. The *juntas* or meetings and *cabildos* (formal religious and political meetings) of noble *cofradías* such as Santiago de la Espada, and *cofradías pasionarias* like Nuestro Padre Jesús Nazareno constituted a social structure themselves. Only nobles could be members of the *cofradía* of Santiago de la Espada. They met at *cabildos* in Murcia's city hall, a membership full of *regidores* who were also part of the *cabildos* of the *concejo*.<sup>80</sup> During the seventeenth and early eighteenth centuries, the members of the Nuestro Padre Jesús Nazareno *cofradía* were individuals from emerging socioeconomic levels such as artisan and traders' guilds. Later in the mid-eighteenth century the majority of the members were from the Murcian oligarchy, almost mirroring the constituents of the *cofradía* of Santiago de la Espada.<sup>81</sup>

Consanguine, spiritual and other familial types of relations, as well as friendship, patronage, clientelism and those affairs that develop in spaces of sociability such as *cofradías*, all map the social apparatus of the Riquelme. They also made up a thick screen of relations representing the entire spectrum of the Murcian oligarchy.<sup>82</sup> Still, the sources do not give a complete picture – parish records, for example, provide scattered information and thus to trace an exhaustive and lineal chronology of events is not always possible. The closer to the nineteenth century, however, the more complete the sources are.

Social connections provide hints on how to reconstruct the social network. The starting point is the individual's personal relations, and the entire structure that operates inside the group. It is essential to examine closely what was written about certain individuals using prosopography.<sup>83</sup> The case of Antonio Fontes Paz, third marquis of Torre Pacheco's social trajectory is important, for example, for learning about the social mechanisms and tracing the changes that the Riquelme-Fontes group performed and experienced in the second half of the eighteenth century. Furthermore, these social trajectories are representative of broader social changes ongoing in the transition from the *ancien régime* to modern societies in the eighteenth and nineteenth centuries.

The social relationships between Riquelme-Fontes and the high clergy are clearly stated in the baptismal and marriage records, and though these are fewer in number than the relationships

Table 3.9 Baptismal and marriage records, sixteenth to eighteenth centuries<sup>84</sup>

Parish records	Date	Priest	Godparents	Witnesses
Baptism of Juan Riquelme y Cervellon	22 March 1591	Hernando Melgar (priest of San Lorenzo)	Antonio Riquelme, Ginesa Castellanos (married)	
Baptism of Macías Fontes Riquelme	26 October 1601, San Bartolomé	Martín Pastor de Medina ( <i>racionero</i> of the cathedral)	Esteban Guil Riquelme ( <i>arcediano</i> of the cathedral)	
Baptism of Cristóbal Fontes Riquelme	31 December 1610, San Bartolomé	Roque Martínez (priest of Santa María)		
Baptism of Antonio Fontes Riquelme	5 January 1621, San Bartolomé	Roque Martínez	Pedro Fontes de Albornoz and Josefa Tomas (married)	
Baptism of Dionisia de Paula Galtero de la Peraleja	27 January 1621, San Bartolomé	Gines Torrente (priest of the church)	Cristóbal Galtero and Luisa Pagán (married)	
Baptism of Baltasar Fontes Avilés	29 July 1627, San Bartolomé	Gines Torrente	Pedro Fontes de Albornoz, María Fontes de Albornoz	
Baptism of Macías Fontes Carrillo (first marquis of Torre Pacheco)	28 January 1648, San Bartolomé	Diego Reynoso ( <i>racionero</i> of the cathedral)	Ambrosio Fontes Carrillo (Macías's uncle), Laura Fontes de Avilés	

Table 3.9 Baptismal and marriage records, sixteenth to eighteenth centuries<sup>84</sup> (Continued)

Parish records	Date	Priest	Godparents	Witnesses
Baptism of Ana-Ceferina Melgarejo Galtero	5 November 1648, San Bartolomé	Pedro Cifuentes	Diego Reynoso	
Baptism of Pedro Fontes Carrillo	20 March 1655, San Bartolomé	Pedro Pérez de Solarte	Pedro de Avalos and Violanta Rocamora (married)	
Baptism of Baltasar Fontes Melgarejo (second marquis of Torre Pacheco)	14 March 1675, San Bartolomé	Diego Peñuela de la Cerda	Ambrosio Fontes Carrillo (permanent <i>regidor</i> of Murcia)	
Baptism of Ventura Fontes de Paz	21 July 1706, San Bartolomé	Damian Abril Corbalan ( <i>teniente</i> priest of Santa María)	Baltasar Fontes Melgarejo (Ventura's father)	
Baptism of Antonio Fontes Ortega	27 May 1725, San Miguel	Alonso de Huesca y Santiago	Brother Matias de Jesus (from the <i>Colegio de Santa Teresa de Jesús</i> )	Baltasar Fontes, Antonio Sandoval, Juan de Córdoba

Table 3.9 Baptismal and marriage records, sixteenth to eighteenth centuries<sup>84</sup> (Continued)

Parish records	Date	Priest	Godparents	Witnesses
Baptism of Francisca Riquelme y Buendia	10 October 1737, San Bartolomé	Francisco de la Torre ( <i>teniente</i> priest of Santa María)	Francisco Riquelme (paternal grandfather)	
Baptism of María de los Remedios Fontes Riquelme	14 July 1759, San Bartolomé	Julian Navarro ( <i>teniente</i> priest of Santa María)	Joaquín Riquelme y Togados (maternal grandfather)	
Baptism of Joaquín María Fontes Fernández de la Reguera	13 March 1799, San Bartolomé	Isidro Bustillo (priest of Santa María)	Antonia Sancho y Simo (maternal grandmother)	
Marriage of Diego Riquelme de Comontes = Luisa Fontes de Albornoz	16 February 1605, San Bartolomé	Gines Torrente		Don Francisco Galtero, Pedro Fernández ( <i>presbítero</i> )
Marriage of Francisco Galtero = Aldonza Riquelme	16 February 1605, San Bartolomé	Gines Torrente		Diego Riquelme de Comontes, Pedro Fernández ( <i>presbítero</i> )

Table 3.9 Baptismal and marriage records, sixteenth to eighteenth centuries<sup>84</sup> (Continued)

Parish records	Date	Priest	Godparents	Witnesses
Marriage of Diego Melgarejo de Mora = Dionisia de Paula Galtero de la Peraleja	7 May 1635, San Bartolomé	Antonio de Prado Mariscuela ( <i>Inquisidor</i> of Murcia)		Francisco Tomas (knight of Santiago), Bernardino de Barrionuevo (knight of Santiago), Antonio de la Peraleja ( <i>regidor</i> of Murcia) Antonio de Albornoz ( <i>regidor</i> of Murcia)
Marriage of Baltasar Fontes y Avilés = Isabel Francisca Carrillo Marin	10 February 1654, San Bartolomé	<i>Licenciado</i> Miguel Carrion		?
Marriage of Francisco Melgarejo y Galtero = Catalina Fontes y Carrillo	25 September 1667, San Bartolomé	Diego Albornoz (treasurer and <i>canónigo</i> of the cathedral)		Pablo de Almela, Diego Fontes, Gregorio de Paz ( <i>regidor</i> of Murcia)

Table 3.9 Baptismal and marriage records, sixteenth to eighteenth centuries<sup>81</sup> (Continued)

Parish records	Date	Priest	Godparents	Witnesses
Marriage of Macías Fontes Carrillo (first marquis of Torre Pacheco) = Ana-Ceferina Melgarejo Galtero	16 February 1670, San Bartolomé	Juan Antonio de Verastegui ( <i>canónigo magistral</i> of the cathedral)		<i>Licenciado</i> Alonso García de Leon ( <i>presbítero</i> ), Gregorio de Paz, Juan Lucas Marin ( <i>regidor</i> of Murcia)
Marriage of Francisco de Borja Fontes y Riquelme = Felipa María Abad y Ulloa	10 January 1771, San Miguel	José Zamora (priest of San Miguel)		Juan Fernández de Beunache ( <i>canónigo</i> , knight of Calatrava), Antonio Damaso Melgarejo (knight of Santiago), Rafael Baldes Fernández de Córdoba



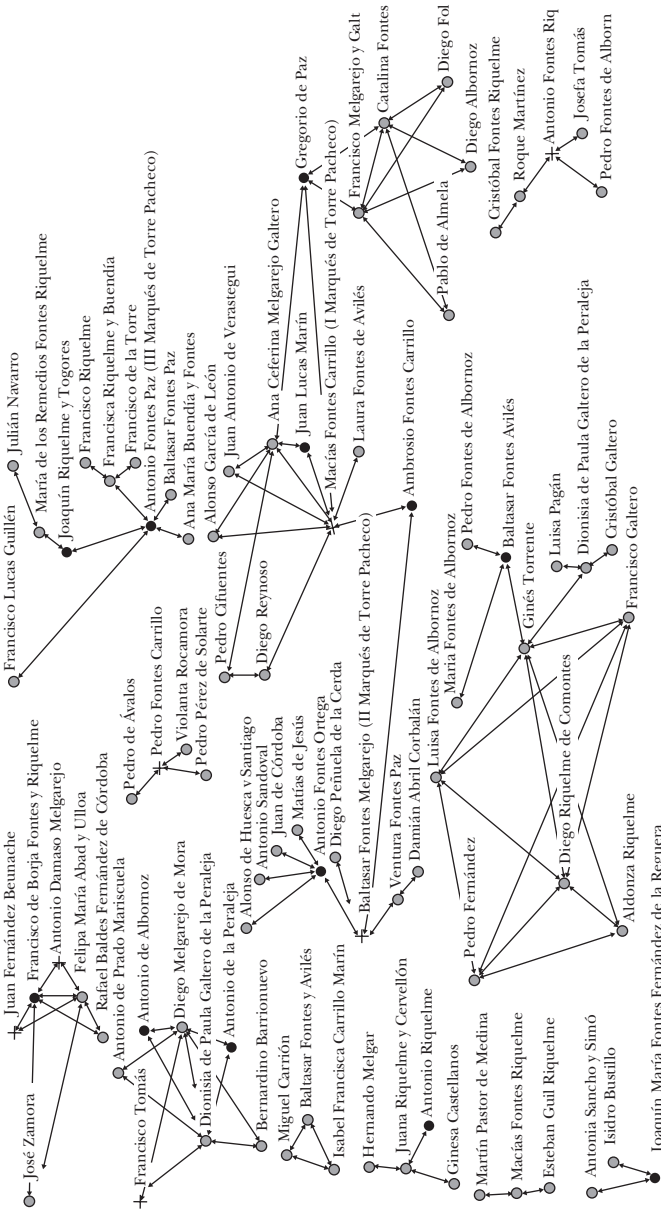
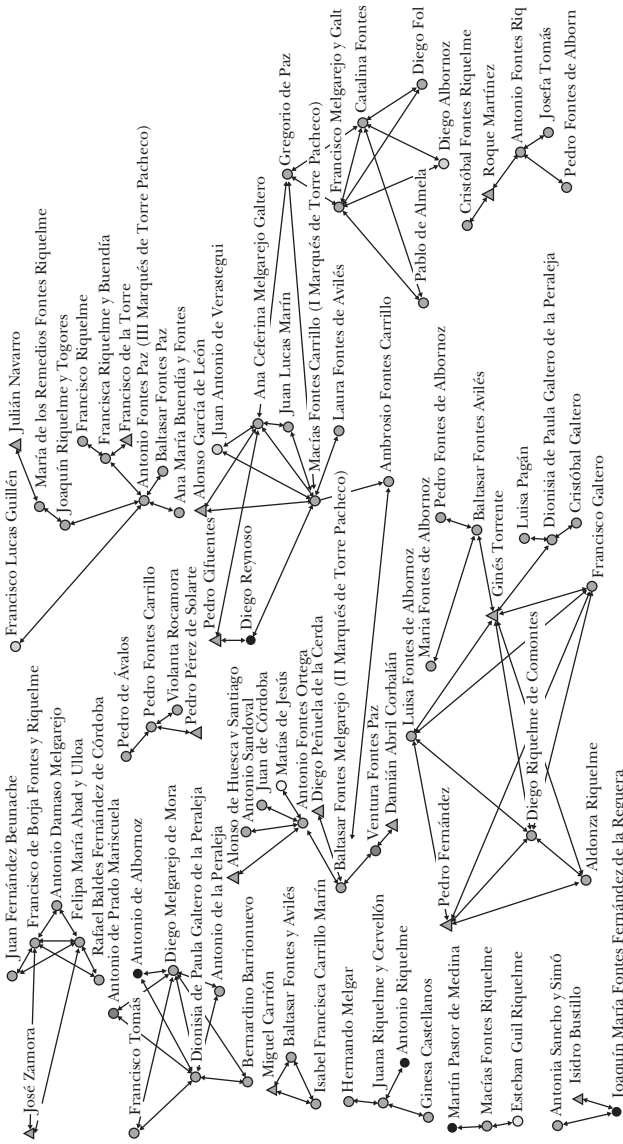

Figure 3.5 Social network of Riquelme and Fontes families in the *Concejo* (1700–1820)

legend: black circle (*regidor*; councillor/alderman); grey cross (military order knight); black cross (councillor and military order knight); grey circle (members of the Riquelme lineage or people and part of its extended family or social network)



**Figure 3.6** Social network of Riquelme and Fontes families in ecclesiastical institutions (1700–1820)

legend: black circle (prebendary/distributor of rations); white circle (archdeacon); light grey circle (Holy Office); black square (colleague); grey square (canon); grey triangle (low clergy member); grey circle (clergy member); grey circle (members belonging to the Riquelme lineage or who are part of their extended family or social network)

established with the lower clergy, qualitatively they were more important. In other words, the family names with whom the Riquelme-Fontes created ties were those of oligarchic families with key positions in the *cabildo catedralicio*, which ultimately strengthened the solidarity, patronage and clientelist relations between the Riquelme group and the ecclesiastical elite (see figures 3.5 and 3.6).

Witnesses and godparents were not chosen randomly to be part of the traditional religious ceremonies. As mentioned before, the Riquelme selectively picked members of their own family or from the urban oligarchy for marriage and baptismal events. *Compadrazgo* (joint godparenting, ritual kinship)<sup>85</sup> became the main element of connection among individuals involved in these closer and eventually narrow relationships of the local elite.

The family names that were related to the Riquelme through these kinds of relationships were also the ones that were connected

**Table 3.10** Life-cycle of Antonio Fontes Paz (third marquis of Torre Pacheco)<sup>86</sup>

Parish records	Date	Priest	Godparents	Witnesses
Baptism	7 November 1730, Santa María (Murcia)	Don Francisco Lucas Guillén ( <i>presbítero, chantre, canónigo dignidad</i> )	Baltasar Fontes de Paz (his brother)	
Marriage with Francisca Riquelme y Buendia (daughter of Joaquín Riquelme y Togores and Ana María Buendia y Fontes)	27 July 1753, San Nicolás (Murcia)			

Table 3.11 Notarial records<sup>87</sup>

Protocol	Date	Main actor	Witnesses
<i>Oficio de regidor</i>	11 September 1758	From Don José Fontes y Barrionuevo (his spouse's grandfather's uncle, Francisca Riquelme y Buendía)	Don Geronimo Guirao, Don Gonzalo Chamorro Leonis, Don Andres Valera
<i>Arrendamiento</i>	14 April 1761	Bartolomé Espinosa (resident of Murcia, <i>morador</i> of the Palmar)	Don Gines Conde Gonzalez ( <i>procurador</i> of Murcia), Martin Fontes Lopez, Fernando Castilblanque y Hervás
<i>Poder</i>	1 June 1761	José Guillén (resident of Archena)	Martin Tortosa Lopez (scribe of His Majesty), Fernando Castilblanque y Hervás, Don Juan Ruiz Valero ( <i>procurador</i> of Murcia) (all residents of Murcia)
Transaction	21 June 1761	Monastery of Nuestra Señora de Aniago (Cartuja Order)	Don Juan Ruiz Valero, Don Gines Gonzalez Conde, Fernando Castilblanque y Hervás

Table 3.11 Notarial records<sup>87</sup> (Continued)

Protocol	Date	Main actor	Witnesses
<i>Poder para testar</i>	13 December 1761	Doña Francisca Riquelme y Buendia (his wife), Francisco Riquelme y Galtero (his wife's grandfather), Don Joaquín Riquelme y Togores (his father-in-law), Don José de Avellaneda (his brother-in-law), Don García Barrionuevo y Tizon (his brother-in-law), Don Antonio Fontes Ortega (his brother-in-law), Don Fernando Melgarejo (his brother-in-law), Don Juan Ruiz Valero ( <i>procurador</i> of Murcia)	Don Martin Tortosa Lopez (scribe of His Majesty), Don Fernando Castilblanque y Hervás, Don Ventura de Cuenca (all residents of Murcia)
<i>Arrendamiento</i>	29 January 1781	Antonio Gallego (resident of Murcia, <i>morador</i> in Alguazas)	Don Antonio Navarro y Heredia, Don Patricio de Vivanco Lardin, José Mateo Conesa
<i>Trueque y cambio</i>	8 March 1781	Nicolas Martínez and Joséfa Ruiz (spouses, residents of Murcia, <i>moradores</i> of Torre Pacheco)	Don Patricio de Vivanco Lardin, Don Fernando Lafuente, Don Antonio Sanchez García (all residents of Murcia)
<i>Venta real</i>	16 March 1781	Ana María Sanz Guillén (resident of Murcia, <i>moradora</i> in Torre Pacheco)	Don Fernando Lafuente, Don Antonio Navarro y Heredia, Don Patricio de Vivanco Lardin (all residents of Murcia)

Table 3.11 Notarial records<sup>87</sup> (Continued)

Protocol	Date	Main actor	Witnesses
<i>Venta real</i>	20 March 1781	Bernardino Sanchez and Tomas Sanchez (siblings, residents of Murcia, <i>moradores</i> in Torre Pacheco)	Don Fernando Lafuente, Don Patricio de Vivanco Lardin, José Mateo Conesa
<i>Poder general</i>	5 May 1781	Agustin Valverde, Nicolás Serrano, Juan de Alcorcon y Torres, José García de Roda (all <i>procuradores</i> of Murcia)	Don Ventura Jordan ( <i>procurador</i> of Murcia), Don Juan Mejia, Don Juan Martínez (all residents of Murcia)
Added to the <i>vínculo</i> founded by his wife	12 May 1783	The houses that Francisca Riquelme bought were given to Doña María Bordonave (resident of Denia) married to Don Francisco de Bousac	Don Antonio Navarro y Heredia, Don Patricio de Vivanco Lardin, Don Ambrosio de Moya Resalt (all residents of Murcia)
<i>Arrendamiento</i>	15 May 1783	José Ortuño; José Mula	Francisco Lucas Frutos, Don Patricio de Vivanco Lardin, Don Ambrosio de Moya Resalt (all residents of Murcia)
Payment letter and dowry	20 January 1788	Provides his daughter Doña Segunda Fontes Paz a dowry to marry Don Juan José Fernández de la Reguera y Sancho	Don Antonio Navarro y Heredia, Miguel Gutiérrez y Jimenez, Don Jaime Salazar y Trives (all residents of Murcia)

Table 3.11 Notarial records<sup>87</sup> (Continued)

Protocol	Date	Main actor	Witnesses
Added to the <i>vinculo</i> founded by his wife	20 January 1788	The mentioned <i>vinculo</i> was Doña Segunda Fontes Riquelme's (his daughter) possession	Don Antonio Navarro y Heredia, Miguel Gutierrez y Jimenez, Don Jaime Salazar y Trives
Donation	20 January 1788	Donates <i>alhajas</i> to his daughter Doña María de los Remedios Fontes Riquelme, spouse of Don Bernardo Riquelme Salafranca y Rocha (marquis of Pinares)	
Deed of dowry	20 January 1788	Provides a dowry for his daughter Doña María de los Remedios Fontes Riquelme	
Obligation letter and dowry receipt	20 January 1788	For Don Juan José Fernández de la Reguera y Sancho as husband of Doña Segunda Fontes Riquelme	Don Antonio Navarro y Heredia, Miguel Gutierrez y Jimenez, Don Jaime Salazar y Trives

Table 3.11 Notarial records<sup>87</sup> (Continued)

Protocol	Date	Main actor	Witnesses
Will	20 January 1788	<p><i>Albaceas testamentarios:</i></p> <ul style="list-style-type: none"> <li>- Don Joaquín Fontes Riquelme (his son)</li> <li>- Don Bernardo Riquelme Salafrañca y Rocha, marquis of Pinares (his son in law)</li> <li>- Don Juan José Fernández de la Reguera y Sancho (his son-in-law)</li> <li>- Don Antonio Fontes Ortega (his brother-in-law)</li> <li>- Don García Barrionuevo (his brother-in-law)</li> <li>- Don Pedro Fernández de la Reguera</li> <li>- Don Francisco de Borja Fontes y Riquelme (his nephew)</li> <li>- Don Jesualdo Riquelme y Fontes (his brother in law)</li> <li>- Don Nicolás Avellaneda y Fontes (his nephew)</li> <li>- Don Diego Melgarejo y Buendía (his nephew) (all residents of Murcia)</li> </ul> <p><i>Herederos universales:</i></p> <ul style="list-style-type: none"> <li>- Don Joaquín Fontes Riquelme</li> <li>- Doña María de los Remedios Fontes y Riquelme</li> <li>- Doña Segunda Fontes y Riquelme (her children, residents of Murcia)</li> </ul>	<p>Don Antonio Navarro y Heredia, Miguel Guitierrez y Jimenez, Don Jaime Salazar y Trives</p>



Table 3.11 Notarial records<sup>87</sup> (Continued)

Protocol	Date	Main actor	Witnesses
<i>Poder general</i>	17 April 1788	Francisco García Comendador ( <i>procurador</i> of Murcia), Agustín Valverde ( <i>procurador</i> of Murcia), Ventura Jordán ( <i>procurador</i> of Murcia), Don Alejandro Moreno de Santa María ( <i>procurador</i> of the <i>Chancillería</i> of Granada), Don Salvador Echeverría ( <i>procurador</i> of the <i>Chancillería</i> of Granada)	Antonio Navarro Heredia, Don Tomas Pedriñan y Galtero, Don Jaime Salazar y Trives (all residents of Murcia)
<i>Poder</i>	17 April 1788	Alfonso Rodríguez de Navarra Mergelina	Antonio Navarro Heredia, Don Tomas Pedriñan y Galtero, Don Jaime Salazar y Trives
Deed of obligation	5 May 1788	Joaquín Riquelme y Fontes (his son), Nicolás Serrano y Abadía ( <i>procurador</i> of Murcia)	Domingo Lopez Antonio Navarro Heredia, Don Jaime Salazar y Trives
<i>Consignación de viudedad</i>	7 May 1788	Doña Isabel de Navarra y Mergelina (his second wife)	Domingo Lopez, Vicente Mengual, Don Jaime Salazar y Trives (all residents of Murcia)
Inheritance of his <i>vínculos</i> and <i>mayorazgos</i>	7 May 1788	Joaquín Riquelme y Fontes (his son)	Domingo Lopez, Vicente Mengual, Don Jaime Salazar y Trives

Table 3.11 Notarial records<sup>87</sup> (Continued)

Protocol	Date	Main actor	Witnesses
Deed of dowry	24 May 1788	Doña Isabel de Navarra y Mergelina	
<i>Cobdicio</i>	24 May 1788		Pedro Abril, Don Jaime Salazar y Trives, Domingo Lopez (residents of Murcia)
<i>Consignación de viudedad</i>	15 October 1788	Doña Isabel de Navarra y Mergelina (his second wife)	Antonio Navarro Heredia, Pedro Abril, Don Jaime Salazar y Trives

to the family through familial kinship, an old marriage, or because they were included in a political faction of their *allegados*. All these relationships were embedded in particular social and political interests, and especially in economic advantage. From having established connections based either on blood ties or unions based on fictitious kinship with names such as Fontes Carrillo, Rocamora, Pagán, Fontes Alborno, de la Peraleja and Paz, the Riquelme founded *mayorazgos* that eventually increased their family patrimony.

Notarial records and the events they refer to, such as *arrendamientos* (leases), sales, *cartas de otorgamiento de poder* (letters granting

**Table 3.12** Frequency of individuals/relations with Antonio Fontes Paz<sup>88</sup>

Social actor	Frequency (%) of relations with Antonio Fontes Paz
Abril, P.	20
<b>Castilblanque y Hervás, F.</b>	40
Chamorro y Leoni, G.	10
de Cuenca, V.	10
de Moya y Resalt, A.	20
<b>de Vivanco Lardín, P.</b>	60
Echeverría, S.	10
Fontes López, M.	10
Gallego, A.	10
García Comendador, F.	10
González Conde, G.	20
Guillén, J.	10
Guirao, G.	10
Gutiérrez Jiménez, M.	30
Jordan, V.	20
Lafuente, F.	30
<b>López, D.</b>	40
Lucas Frutos, F.	10
Martínez, J.	10
Mateo Conesa, J.	20
Mejía, J.	10

**Table 3.12** Frequency of individuals/reasons with Antonio Fontes Paz<sup>88</sup>  
(Continued)

Social actor	Frequency (%) of relations with Antonio Fontes Paz
Mengual, V.	20
Moreno de SantaMaría, A.	10
<b>Navarro Heredia, A.</b>	60
Pedriñan y Galtero, T.	20
Ruiz y Valero, J.	30
<b>Salazar y Trives, J.</b>	60
Sanchez, B.	10
Sanchez, T.	10
Sanchez García, A.	10
Tortosa Lopez, M.	20
Valera, A.	10
Valverde, A.	10

**Bold type** indicates the individuals with more occurrences of links with Antonio Fontes Paz.

**Table 3.13** Position of *regidor*: purity of blood examination of Antonio Fontes Paz<sup>89</sup>

Witnesses	Position	Residence
Don Pascual de Aguado y Olivares	<i>Regidor</i> of Murcia	Murcia
Don Sancho de la Reguera	A known knight of Murcia	Murcia
Don Agustin Fernández de Lesma	<i>Presbítero</i> and <i>prebendado</i> of the cathedral of Murcia	Murcia
Don Rodrigo Galtero	A known knight of Murcia	Murcia
Don Fernando Sandoval	A known knight of Murcia	Murcia

powers) and deeds of dowry provide a guide as to how to reconstruct the extensive network of social relationships and the level of closeness to Antonio Fontes Paz. In cases of *arrendamientos* of land, family members and other individuals such as labourers and peasants living on the lands of the Riquelme-Fontes (Alguazas, Palmar,

Torre Pacheco), are referenced. Their relation is markedly a vertical one based on clientelism and patronage.

Likewise, the records contain a description of the witnesses of these legal events. The recurrent presence of some of the individuals at different events is worth noting, and although it is difficult to know their social status, the *Don* can denote that they are professionals such as scribes, notaries or *procuradores*.<sup>90</sup> This is evidence of the closed relations with the middle- to high-level status that was entering the social pyramid of the *ancien régime*. Other witnesses included individuals educated in law and letters emerging at a time when lawsuits and other judicial issues were overwhelming the *Tribunales de Justicia Ordinarios*, the *Chancillería* and the *Consejo Real*. Inheritance and intrafamilial disputes and complaints resulting from issues with *mayorazgos* were filling up the *tribunales*, a topic that chapter four examines further.

Witnesses used for purity of blood examinations to become *regidor* were commonly individuals closely related – sometimes with a direct kinship relation to the main actor, even when it was known that relatives were not allowed to testify in favour of the candidate. Witnesses were generally oligarchic urban figures who, as tables 3.11 and 3.12 show, have family names that have a close link to the main actor through other types of economic, social, religious or political venues.

Records like reports from meetings and *cabildos* of *Cofradías*, such as that of the nobles of Santiago de la Espada or the *Cofradía pasionaria* Nuestro Padre Jesús Nazareno, represent a key space of the elite's sociability and thus provide clues to help analyse more broadly the Riquelme's social network. These sources do not only identify individuals; they also document the social status of all the individuals connected to the Riquelme. The difference between tables 3.12 and 3.13 is mainly about the social origins of individuals related to Antonio Fontes Paz. In earlier years he was frequently related to individuals such as *procuradores* or lawyers of the middle social strata who assisted him in judicial processes, or with labourers and peasants who rented his lands. Later, as table 3.13 shows, Fontes Paz appeared related to equals in the *Cofradías* of Santiago de la Espada and Nuestro Padre Jesús Nazareno, creating a closed oligarchic body.

Table 3.14 situates Antonio Fontes Riquelme (third marquis of Torre Pacheco) at the centre in order to map the relationships that emerged with other relevant family names as well as the *cabildos*

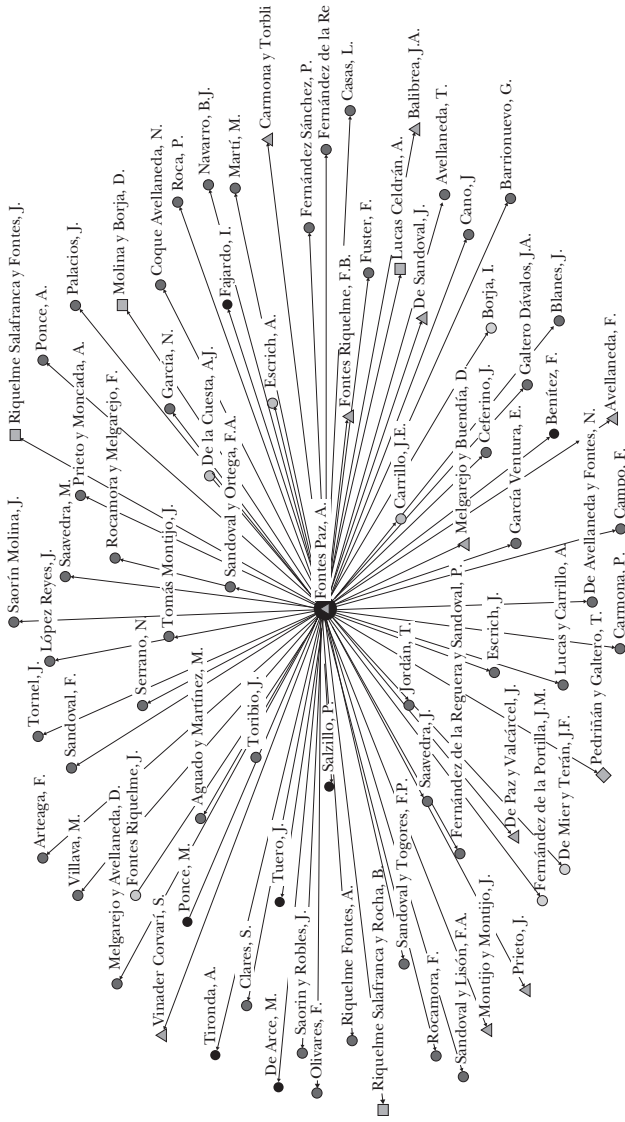

Figure 3.7 Antonio Fontes Paz's (third marquis of Torre Pacheco) social network through the *Cofradías* of Santiago de la

*Espada* and *Nuestro Padre Jesús Nazareno* (1700–1820)<sup>91</sup>

Legend: triangle (councillor/alderman); black circle (presbyter); white circle (cathedral prebendary); grey square (nobility title); white square (Holy Office); grey diamond (syndic procurer); dark grey circle (no office mentioned).

**Table 3.14** Frequency of relations of Antonio Fontes Paz with individuals of the *Cofradías of Santiago de la Espada* and *Nuestro Padre Jesús Nazareno* (1700–1820)<sup>92</sup>

<b>Social actor</b>	<b>Frequency (%) of relations with Antonio Fontes Paz</b>	<b>Social actor (continued)</b>	<b>Frequency (%) of relations with Antonio Fontes Paz</b>
<b>Aguado y Martínez, M.</b>	50	Lopez Reyes, J.	10
<b>Avellaneda, F.</b>	90	Lucas Celdran, A.	20
<b>Arteaga, F.</b>	50	Lucas y Carrillo, A.	10
Avellaneda, T.	10	Marti, M.	20
Balibrea, J. A.	10	Melgarejo y Avellaneda, D.	10
<b>Barrionuevo, G.</b>	50	Melgarejo y Buendia, D.	20
Benitez, F.	40	Molina y Borja, D.	20
Blanes, J.	10	Montijo y Montijo, J.	20
<b>Borja, I.</b>	90	Navarro, B. J.	10
Campo, F.	10	Olivares, F.	10
Cano, J.	10	Palacios, J.	10
<b>Carmona, P.</b>	80	<b>Pedriñan y Galtero, T.</b>	80
<b>Carmona y Toribio, J.</b>	60	Ponce, A.	20
Carrillo, J. E.	10	<b>Prieto, J.</b>	80
Cacas, L.	20	Prieto y Moncada, A.	20
Ceferino, J.	10	<b>Riquelme y Fontes, J.</b>	70
Clares, S.	10	<b>Riquelme Salafranca y Fontes, J.</b>	50

**Table 3.14** Frequency of relations of Antonio Fontes Paz with individuals of the *Cofradías of Santiago de la Espada* and *Nuestro Padre Jesús Nazareno* (1700–1820)<sup>92</sup> (Continued)

Social actor	Frequency (%) of relations with Antonio Fontes Paz	Social actor (continued)	Frequency (%) of relations with Antonio Fontes Paz
Coque y Avellaneda, N.	10	<b>Riquelme Salafranca y Rocha, B.</b>	80
<b>de Arce, M.</b>	90	Roca, P.	20
<b>de Avellaneda y Fontes, N.</b>	70	Rocamora, F.	10
<b>de la Cuesta, A. J.</b>	90	Rocamora y Melgarejo, F.	20
de Mier y Teran, J.F.	10	Saavedra, J.	10
<b>de Paz y Valcarcel, J.</b>	90	Saavedra, M.	10
<b>de Sandoval, J.</b>	90	Salzillo, P.	10
<b>Escrich, A.</b>	60	Sandoval, F.	10
<b>Escrich, J.</b>	60	Sandoval y Lison, F. A.	30
Fajardo, I.	10	<b>Sandoval y Ortega, F. A.</b>	80
<b>Fernández de la Portilla, J. M.</b>	80	Sandoval y Togores, F. P.	20
<b>Fernández de la Reguera y Sancho, J. J.</b>	90	<b>Saorin y Molina, J.</b>	40
<b>Fernández de la Reguera y Sandoval, P.</b>	60	<b>Saorin y Robles, J.</b>	60
Fernández Sanchez, P.	50	Serrano, N.	10
<b>Fontes y Riquelme, F. B.</b>	90	Tironda, A.	10
<b>Fontes y Riquelme, J.</b>	90	Tomas Montijo, J.	10
<b>Fuster, F.</b>	50	Toribio, J.	30



**Table 3.14** Frequency of relations of Antonio Fontes Paz with individuals of the *Cofradías of Santiago de la Espada* and *Nuestro Padre Jesús Nazareno* (1700–1820)<sup>92</sup> (Continued)

Social actor	Frequency (%) of relations with Antonio Fontes Paz	Social actor (continued)	Frequency (%) of relations with Antonio Fontes Paz
Galtero Davalos, J. A.	20	Tornel, J.	20
García, N.	30	Tuero, J.	20
García Ventura, E.	1	Villalva, M.	1
Jordan, T.	1	Vinader Corvari, S.	3

**Bold type** indicates the individuals with more occurrences of links with Antonio Fontes Paz.

and meetings in which he participated annually as one of the main members of the *cofradías*. The members of the *Cofradía* of Santiago de la Espada were part of the elite, given the fact that all members had passed a purity of blood examination. Most important, however, are the relationships documented in the *cabildos* and meetings of the *Cofradía* of Santiago with the members of *Nuestro Padre Jesús Nazareno*, with members coming both from the middle and high social strata.

The *Cofradía* of *Nuestro Padre Jesús Nazareno* experienced a process of ennoblement in the eighteenth century as members from the *Cofradía* of Santiago became members of both (see graph 3.1). Records from meetings and *cabildos* of *mayordomos* show elite surnames from illustrious people, *titulados*, *regidores* and high clergy individuals. Ennoblement deepened in the nineteenth century as a result of a substitution effect between the *cofradías* – the *cabildos* of Santiago became smaller, with the last one in 1820, while the ones for *Nuestro Padre Jesús* continued with many of the members coming from other *cofradías*, including main family members of the Murcian oligarchy.<sup>93</sup> The data show the *cabildos* and meetings in which Don Antonio Riquelme y Fontes (lord of Guadalupe) participated as a key member of the *cofradías*. Riquelme y Fontes became

*mayordomo* in Santiago and dean *mayordomo* in Nuestro Padre Jesús on 10 May 1812.<sup>94</sup> Although in the early nineteenth century the meetings of Nuestro Padre Jesús were often crowded, eventually, as the century progressed, its membership decreased. Through time, however, some of its participants continued to come from the top illustrious families.

At certain times, only members of the Riquelme-Fontes lineage attended *cabildos* in the early to mid-nineteenth century. The oligarchy was still part of a process of social closing and only socialising in elite spaces. The social network of Antonio Riquelme y Fontes (see figure 3.8, and appendix pp. 300, 301) shows the continuity and permanence of some social patterns, and of the stagnation in the Murcian oligarchy that clung to institutions such as *cofradías* to avoid any reduction of their socioeconomic power in the nineteenth century. The reforms that were implemented to establish a more liberal and open society were far from breaking the social fabric that the urban elite had built around concepts such as the group's interest, solidarities, clientelism, friendship and patronage. Indeed, such a process must be understood in the framework of the *longue durée*.<sup>95</sup>

**Table 3.15** Frequency of relationships between Antonio Riquelme y Fontes and other individuals from the *Cofradías* of Santiago de la Espada and Nuestro Padre Jesús Nazareno (1794–1843)<sup>96</sup>

Social Actor	Frequency (%) of relationships with Antonio Riquelme y Fontes
Avellaneda, F.	10
Avellaneda y Fontes, N.	20
<b>Barnuevo y Arcaina, M.</b>	76
de Ortola, B.	20
de Paz y Valcarcel, J.	30
<b>del Villar, J.</b>	70
<b>Eguia, P. A.</b>	60
<b>Esteve, R.</b>	80
Fernández de la Portilla, J. M.	10
Fernández de la Reguera y Sancho, J. J.	50
Fontes Abat, A.	30

**Table 3.15** Frequency of relationships between Antonio Riquelme y Fontes and other individuals from the *Cofradías* of Santiago de la Espada and Nuestro Padre Jesús Nazareno (1794–1843)<sup>96</sup> (*Continued*)

Social Actor	Frequency (%) of relationships with Antonio Riquelme y Fontes
Fontes Fernández de la Requera, J. M.	10
<b>Fontes Riquelme, J.</b>	60
Fontes y Queipo de Llano, M.	30
Fuster de Oliver, J.	40
García y Aguado, J. J.	20
<b>Gomez de Morales, M.</b>	90
<b>Gutierrez de Reina, M.</b>	60
<b>Lucas Celdran, A.</b>	60
<b>Melgarejo, J. M.</b>	50
<b>Melgarejo, M.</b>	50
Melgarejo y Mergelina, J.	20
Molina y Borja, D.	30
Muñiz, L.	30
<b>Riquelme y Arce, A.</b>	50
Riquelme y Fontes, J.	30
<b>Riquelme Salafranca y Fontes, J.</b>	50
Riquelme Salafranca y Rocha, B.	10
Rocamora y Melgarejo, F.	10
Saavedra, M.	10
<b>Salinas Moñino, A. J.</b>	50
Sandoval, F.	10
<b>Sandoval y Togores, F. P.</b>	60
Tribes, M.	10
<b>Uribe y Caro, D.</b>	50
<b>Zarandona y Fontes, L.</b>	50
<b>Zarandona y Prieto, J.</b>	50

**Bold type** indicates the individuals with more occurrences of links with Antonio Riquelme y Fontes.

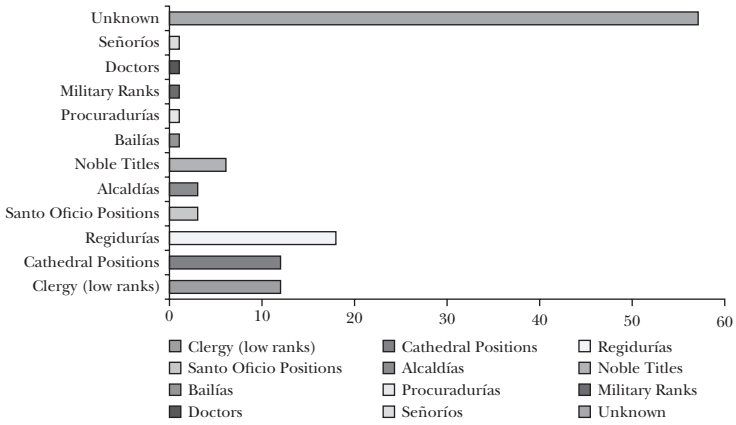

**Graph 3.1** Social status of the members of the *Cofradías* of Santiago de la Espada and Nuestro Padre Jesús Nazareno, seventeenth to nineteenth centuries<sup>97</sup>

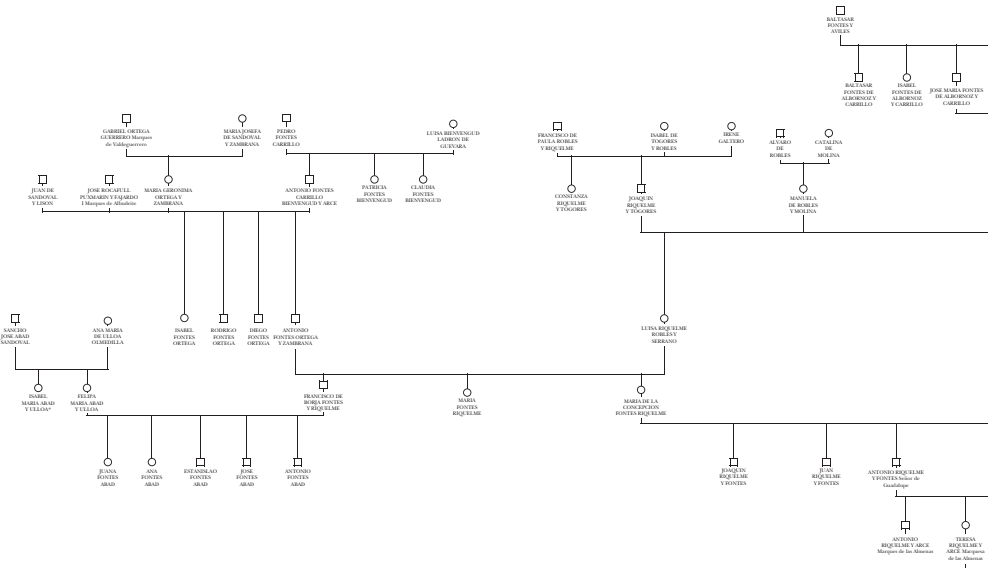
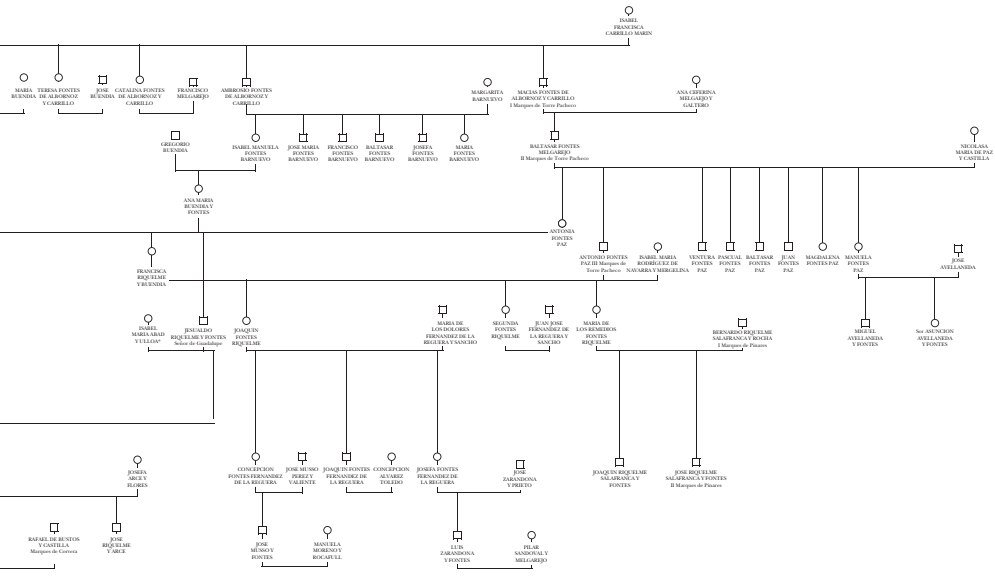

Figure 3.8 Coalition between the Riquelme and Fontes lineages, seventeenth to nineteenth centuries



# Family and Entailed Estate (*Mayorazgo*): First-borns as Keepers of the Family's Economic Power

---

## 4.1. The History and Origins of the *Mayorazgo*, 1507–1841

Established by the thirteenth century in Castile and later in Portugal,<sup>1</sup> the *mayorazgo* was fundamentally an institution with strict links to the property of the nobility that allowed neither *emphyteusis* nor the ability of the monarchy to confiscate the property.<sup>2</sup> The first-born male was the *mayorazgo*'s main pillar – the *ego* or *jefe-patrón* of the lineage. The family's patrimony was mostly linked to the *ego* to avoid its fragmentation and dispersal. The first-born was the main beneficiary – the other siblings were always second – and everyone surrounding him was concerned with securing the continuity and perpetuation of the lineage at all levels.

Through the *mayorazgo*, families of the elite put in practice all kinds of marriage strategies to secure the possession of lands and properties attached to a *mayorazgo*, and also to restrict enough closeness of *parentela* to avoid anyone taking over, in case there was any interruption of the biological line of consanguine heirs. It was a structure that transferred patrimony in the most vertical and condensed way that the Castilian laws could allow, and showed, represented and materialised both the consciousness of the lineage as well as the cultural symbols that were the social baggage of the different lineages. It entailed all the lineage ever wanted: to exist in perpetuity.<sup>3</sup>

This perfectly defined in the Iberian kingdoms the concept of the *mayorazgo* – where the vertical wins over any horizontal hereditary line, though the latter is also used through alliances and marriage strategies to enlarge the *parentela* within the oligarchy and to maintain and increase the social status of the group. As such, two concepts also became key, one connected to the authority of the *pariente mayor* (eldest son and main heir) who secured the cohesion of the members of the lineage; in European Mediterranean communities, everyone understood what roles each person played around him, with the group's interest always a priority.<sup>4</sup> Second was the preservation of the wealth of the family, which conferred on the first-born power over the patrimony, given his succession rights.<sup>5</sup>

The *mayorazgo* remained important in the Spanish monarchy through the late medieval era, during the early modern period and even into the early nineteenth century. There was what can be called a 'culture of *mayorazgo*' in the lineage, making the first-born the head and guide of the family group.<sup>6</sup> The *patrón* led, protected and benefited the group. He also provided an extended, though not uniform, spiritual *parentela*. The system of patronage was thus structured through clientele relationships that were inherited from medieval forms of subordination.<sup>7</sup> As figure 4.1 suggests, the Castilian system of inheritance was nominally egalitarian. However, by observing how the family assets are distributed through the *legítima*, *1/5 de libre disposición* and *1/3 de mejora*, it is difficult to assure such equity.

Although the Castilian inheritance system was, on the surface, egalitarian,<sup>8</sup> the entire set of properties of the family patrimony was divided in three parts. From two of these parts, half (51%) of the inheritance was for the *legítima*, the universal heirs, in equal

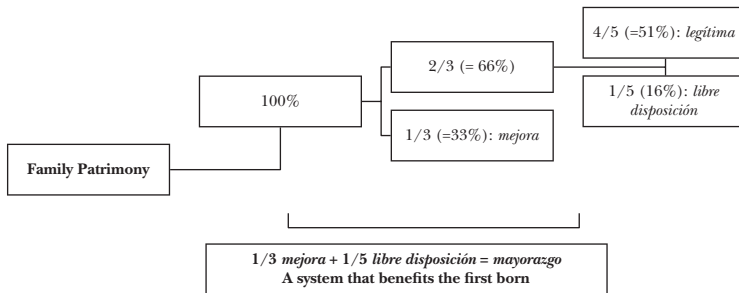

Figure 4.1 Castilian inheritance system



terms. Another section of these two-thirds, 16% called the *1/5 de libre disposición*, was put aside to pay any debts or funerary expenses. The other third, called *1/3 de mejora*, was in place to maintain control over the family patrimony. A set of strategies or *arreglos* was determined for this part of the inheritance to avoid dispersal of any common ownership. The father or the mother had the right to decide how to use this part to benefit one of the children by making a *mejora* (or improvement).<sup>9</sup>

The equality of the system was only superficial, however, because the head of the family employed a set of mechanisms and strategies that undermined it.<sup>10</sup> In most cases, especially in wealthy and powerful families of the urban oligarchy, there were practices in place that sought to keep the family patrimony together. The *mayorazgo* appeared when the one-third *de mejora* and the one-fifth *de libre disposición* became one. As noted above, the main objective was to protect and benefit the first-born – the *jefe-patrón* of the lineage – with the other siblings relegated to second place, the *segundones*, under his tutelage.

In 1505 in the Crown of Castile, the Cortes of Toro institutionalised this structure, regulating the lineage as a kinship system that favoured a vertical line of descent.<sup>11</sup> The horizontal line did not disappear, however, as it remained within endogamy – unions of direct cousins or between uncles and nieces or aunts and nephews that broke the generational line – and with double marriages that united two members of one prestigious family with two members of one of equal or higher social status, so that the social prestige of one of the families was elevated (see figure 4.2).<sup>12</sup> In Mediterranean Europe, all this was fuelled with the objective of maintaining the family patrimony intact and in order to keep socially reproducing the iron-strong lineage group.

Pérez Picazo notes that the *mayorazgo* originated in the Roman juridical formula of *fideicommissum*, ‘a plan sealed in a will or an *acta capitular* or a foundation letter that the founder [of the *fideicommissum*] creates to determine how a group of properties and rights will pass from him to his heirs’.<sup>13</sup> The creation of a connection or tie (*vínculum*) established that a patrimony is indivisible and inalienable, and that the owner has the right to the usufruct but not the capital. In addition, the principle of primogeniture became the main pillar of the succession order.

The process for the foundation of a *mayorazgo* in the Crown of Castile during the early modern period was tightly regulated. First,

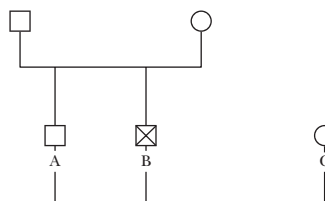

A. Marriage between brother-in-law and sister-in-law (A&amp;C)

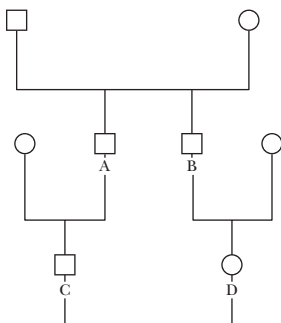

B. Marriage between cousins (C&amp;D)

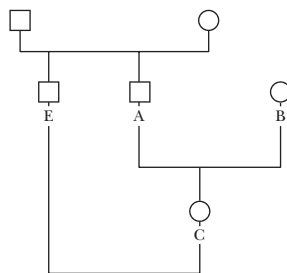

C. Marriage between uncle and niece (E&amp;C)

**Figure 4.2** Endogamy marriages between siblings

the person received a *licencia real* to become judicially authorised to create a *mayoralazgo*. The document itself had the following structure: the preamble that lays out a declaration of principles; the body, that mentions the linked patrimony or *patrimonio vinculado*; and thirdly, an explanation of the succession order that in the majority of the cases is *agnático*, keeping the right of succession for the first-born male and thus establishing that after the death of the

founding father of the *mayorazgo* the patrimony will stay within the lineage.<sup>14</sup> The succession order was not always thoroughly understood, or it was not well explained in the foundation documents, which led *segundones* and other collateral branches of the lineage to claim their rights in the succession of the *mayorazgo*. This inundated the *Tribunales de Justicia Ordinarios* (regional courts), the *Reales Chancillerías* in Granada or Valladolid, and the highest-level court, the *Consejo de Castilla*, with lawsuits about ownership (*tenuta*) and possession of *mayorazgos*. The cases usually started in issues of succession between female and male siblings, or because of the incompatibility of owning more than one *mayorazgo*. Also, the suits often were brought forward by members of the same family, which created intrafamilial conflicts that were prolonged for extended periods of time. The *mayorazgo*, as an important source of income and also of prestige and social and political status, was at the centre of landowner family politics, especially for the *segundones*.

In this context, family names became key to family and inheritance politics. The founding documents of the *mayorazgo* established that to receive the family's patrimony the successor needed to have the family name, which also secured the family's memory over time, generation after generation. Litigants often claimed and even invented their right to inheritance based on having a direct relationship to a certain surname. To avoid fraud, judges required notarial records such as parish records, baptismal, marriage, death and memorial documents that could show extensive genealogies. Even so, these documents were sometimes forged or included false information. If falsity was suspected, the only certain proof would be the will or the foundation letter of the *mayorazgo* in which the founder had outlined the succession line, though this was also often open to interpretation by the litigants.

Settling inheritance cases took a long time in many instances. Protracted cases, however, provide key information about how the Riquelme family patrimonies changed over time, both in quantitative terms and also regarding the social and biological stagnation that the lineage ended up suffering as a result of the enclosed nature of the nobility group. The *estado señorial* was defined through the *mayorazgo*, and as such through the social and power relations that were generated by them.<sup>15</sup> The following section superposes the life of the *mayorazgo*, from its foundation in the early 1500s until 1844, when it was outlawed, with the history of the

Riquelme patrimony, exploring the processes of accumulation, modification and circulation of property through generations.

#### **4.1.1. Family Heritage, Life-cycle and Circulation of Land Property: Wealth Accumulation**

The end of the reconquest war against the Nasrid kingdom of Granada in 1492 meant the cessation of violence in formerly frontier lands in the Crown of Castile and the end of Muslim incursions that many peasants and labourers had endured for centuries. In addition, families began to work the lands they had received as compensation for their role in the war, or those new parcels that they purchased. Peace and conquest meant the beginning of a process of greater land accumulation for noble landowners in Murcia – including the Riquelme lineage – which they maintained throughout the late medieval and early modern period.

Noble prestige and power revolved around land, and also water when living in a dry region like Murcia, where droughts were common, as in the *señorío* of Santo Ángel, parts of which the Riquelme had owned since before the mid-fifteenth century, when Diego Riquelme became the first lord of Santo Ángel.<sup>16</sup> Santo Ángel contained extensive parts of orchard and fruit trees. Other known lineages had also acquired lands in surrounding areas such as Ceutí, Alguazas, Cotillas, and Archena in the valley of the Segura river, which were also parts of *señoríos*.<sup>17</sup>

The lands that the Riquelme began to add to their patrimony after conquest were mostly dry lands of the kingdom of Granada, the lands north of the district of Lorca – largely lands in Campo Coy, next to Caravaca and Cehegín, that the Fajardo donated to the Riquelme lineage at the beginning of the sixteenth century, which they rotated for agriculture with what they already owned in Murcia.<sup>18</sup> Still, Coy and other strategic locations such as Celda, Nogalte and Aguaderas had some water sources or fountains, and the nobility carefully selected these sites to enhance their socio-economic status, and came to be known as *señores del agua* (lords of the water).<sup>19</sup> Thus the Riquelme lineage went a step up in the oligarchy when Diego Riquelme Dávalos became first lord of the *señorío* of Campo Coy and had control over the waters of the Lorca Orchard.<sup>20</sup>

The family, as the consolidating and transmitting channel of feudal property, was at the centre of the nobility.<sup>21</sup> Thereby, the *mayorazgo* became key to the perpetuation and social reproduction

of these elite landowners. Riquelme property presents such a linear circulation of the land over time – the *señorío* of Santo Ángel, which was already extensive when founded in 1544 by Don Cristóbal Riquelme de Arroniz (third lord of Santo Ángel) and his wife Doña Nofra Riquelme and passed to their first-born, Nofre Riquelme de Arroniz (fourth lord of Santo Ángel), remained within the lineage for two centuries (see figure 4.3 and table 4.1).<sup>22</sup>

Although modifications and additions always required the king's permission, the life path of the *mayorazgo* was generally linear. Don Luis Riquelme de Avilés (fifth lord of Santo Ángel) inherited all

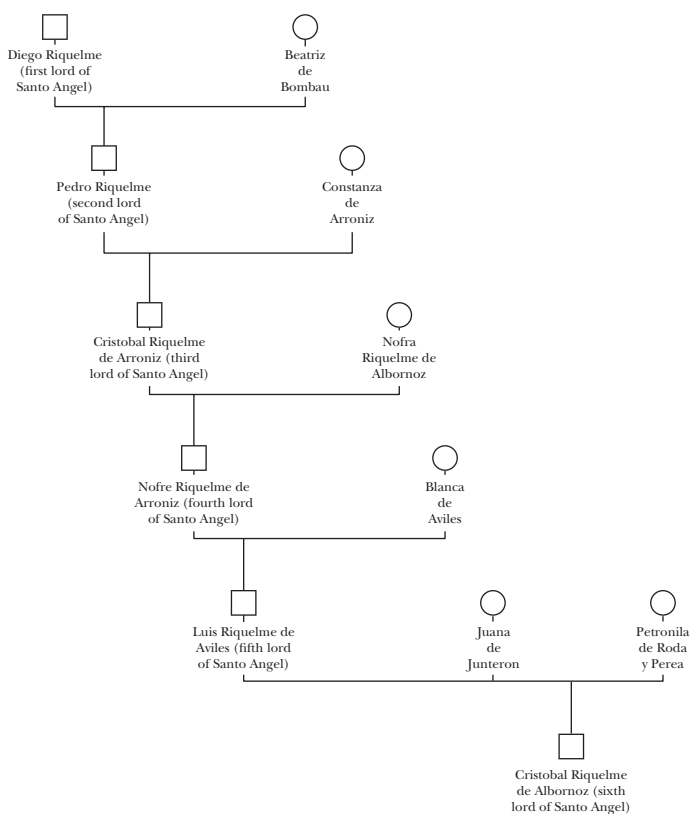

**Figure 4.3** *Señorío* of Santo Ángel, fifteenth to seventeenth century

**Table 4.1** Properties in the *mayorazgo* that Don Cristóbal and Doña Nofra Riquelme created

Property	Place
1 House	<i>Pago</i> of Beniaján (Orchard of Murcia)
Main houses	Parish of San Bartolomé (Murcia)
1 <i>Heredamiento</i> (called Mendigol)	<i>Campo</i> of Cartagena, Murcia city limits, <i>Pago</i> of Mendigol

these properties (see tables 4.1 and 4.2) and added them in 1617 to the *mayorazgo* that Cristóbal Riquelme de Arroniz had founded before.<sup>23</sup> Luis Riquelme's will stated that the properties of the *mayorazgo* should eventually be in the hands of his nephew Don Cristóbal Riquelme de Arroniz (sixth lord of Santo Ángel), son of Don Cristóbal Riquelme Comontes (fourth lord of Coy) and Doña Antonia de Arroniz Riquelme. In quantitative terms, the value of the Riquelme *mayorazgo* was significant, and thus their power within the Murcian oligarchy was clear. These possessions and the economic value that they represented were even more important in times of stagnation and scarcity, or when plagues and wars destroyed the crops.

**Table 4.2** Lists (memorial) of the property linked to Luis Riquelme de Avilés*Fixed Assests*

Property	Place
Main and other houses plus the ones that he purchased from Don Luis Pacheco de Arroniz ( <i>dean</i> of the cathedral)	Parish of San Bartolomé (Murcia)
Three houses purchased from Don Alonso de Tenza Fajardo (knight of Alcántara, lord of Ontanar, Albatán y Espinardo)	

**Table 4.2** Lists (memorial) of the property linked to Luis Riquelme de Avilés (*Continued*)

Property	Place
1 inheritance with main and secondary houses and a palace	<i>Pago</i> of Beniaján, Raiguero de Santa Catalina del Monte, path of La Fuensanta.
1 <i>heredad</i>	San Esteban de Mendigo, Campo de Cartagena, in the jurisdiction of Murcia
118 <i>tahúllas</i>	Rincón de Villanueva
31 <i>tahúllas</i> of <i>morerales</i>	<i>Pago</i> of Alfande y Condomina (Orchard of Murcia)
40 <i>tahúllas</i> of <i>morerales</i>	<i>Pago</i> of El Junco (Orchard of Murcia )
19 <i>tahúllas</i> of <i>morerales</i>	
19 <i>tahúllas</i> of <i>morerale</i> and its house	<i>Pago</i> of Alfande (Murcia's orchard)
17 <i>tahúllas</i> of <i>morerale</i>	<i>Pago</i> of La Condomina (Orchard of Murcia)

## Assests

Textiles	Cash	Furniture	Stock	Harvest	Luxury items	Other
6 satin <i>paños</i>	30 <i>ducados</i> from selling a horse	12 <i>leonadas</i> chairs with <i>herraje</i> and <i>clavazón de oro</i>	Mules and oxen from the <i>heredades</i>	160 oil <i>arobas</i>	1 slave: Ana Pérez	Other goods from his house and <i>hacienda</i> that Francisco Fernández ( <i>mayordomo</i> ) stated

**Table 4.2** Lists (memorial) of the property linked to Luis Riquelme de Avilés (*Continued*)

Textiles	Cash	Furniture	Stock	Harvest	Luxury items	Other
	40 <i>ducados</i> from Fama, <i>mora, en precio de rescate</i>	11 decorated chairs	1 brown horse	70 chickpeas <i>fanegas</i>		
	6.000 <i>maravedíes</i> from Gabriel Barrera who was safeguarding them	3 black chairs	12 cows	65 <i>quintales</i> of <i>barrilla</i>		
		6 <i>bufetes</i> of hickory trees				
		2 curtains				

The *señorío* of Santo Ángel was diverse, with irrigated lands of great value by the Segura river and drier lands in the *Campo* of Cartagena. Overall, though there were more dry lands, the *señorío* was of great value in the mostly dry region of Murcia. Legally it was under an *emphyteusis* right, which made it, in theory, closer to the type of *mayorazgos* that existed in the Catalan and Valencian regions. The Castilian *mayorazgos* prohibited these practices, for example.<sup>24</sup> This clause is what explains Cristóbal Riquelme de Arroniz (sixth lord of Santo Ángel) renting lands from the *mayorazgo* that Cristóbal Riquelme de Arroniz (third lord of Santo Ángel) founded.<sup>25</sup>

The lands that Don Diego Riquelme de Comontes (third lord of Coy) and his spouse Doña Beatriz de Bustamante joined in 1590 were partly from the *heredamiento* of Coy in the city of Lorca next to *atalaya* and *callado llanto*, and also part of Cehegín and Caravaca, and of the *heredad* and *hacienda* of the youngest son of Nicolás



**Table 4.3** Lands rented by Cristóbal Riquelme de Arroniz (sixth lord of Santo Ángel) that were under *mayorazgo*<sup>26</sup>

Rented lands	Renter	Year	Years rented	Value
1 <i>suerte</i> of white land and <i>moreales</i> in the Raiguero of Santa Catalina: - 3 <i>onzas</i> of <i>hoja</i> - 3 <i>tahúllas</i> of white land	Hernando Osete	17 May 1618	4 years	481 <i>reales</i>
1 <i>suerte</i> of <i>moreal</i> in the <i>Pago</i> of Villanueva	Bartolomé Hernández	13 June 1618	4 years	1,100 <i>reales</i>
A house and a <i>heredamiento</i> from the <i>mayorazgo</i> in <i>Pago</i> of Beniaján	Hernando Osete	1618	4 years	
12 <i>suerte</i> in the Raiguero of Santa Catalina 12 <i>onzas</i> of <i>hoja</i> in the <i>moreales</i> of <i>Pago</i> del Junco 1 <i>moreira</i> of dry land	Tomás Navarro	1618	4 years	70 <i>reales</i>
Rental of the principal houses		1624	4 years	900 <i>reales</i>
12 accessory houses		1624	4 years	4,016 <i>reales</i>
Las Motas (lands)	Pedro Manuel	1624	4 years	400 <i>reales</i>
Rented lands in <i>Pago</i> of Villanueva		1626	4 years	7,700 <i>reales</i>
Previously rented lands		1629	4 years	846 <i>reales</i>

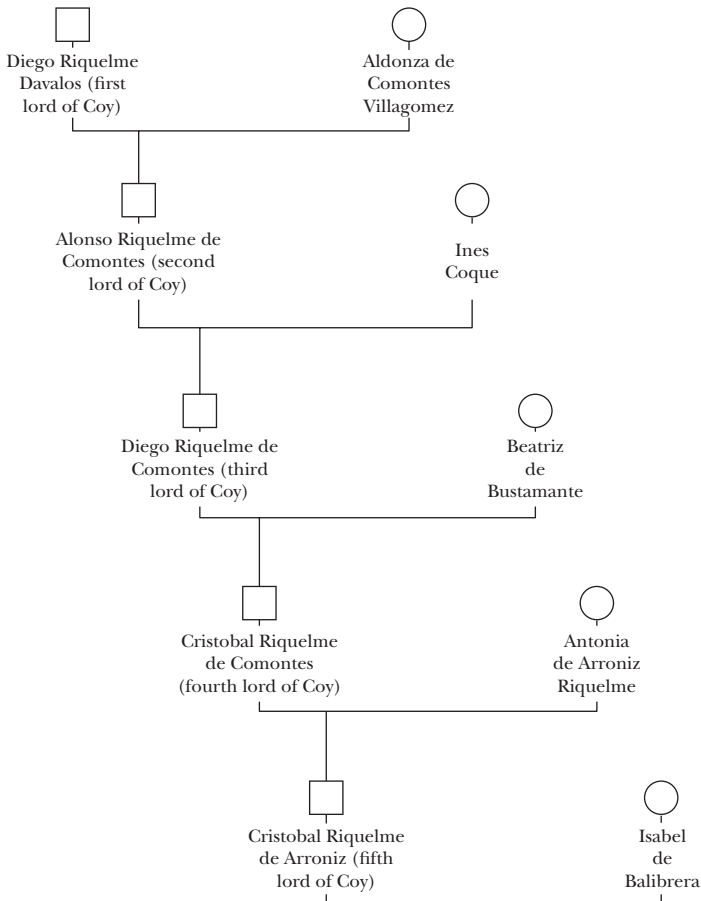
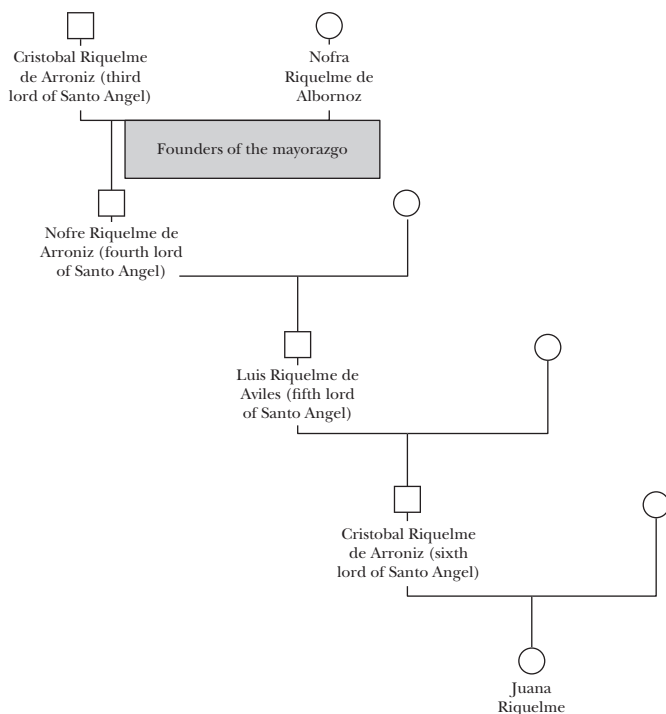

**Figure 4.4** Line of inheritance of the *Señorío* of Campo Coy in the Riquelme lineage, sixteenth to seventeenth centuries

Natarlo.<sup>27</sup> The combination of lands, which secured wooded lands and water sources, came from what Don Diego received from his uncle, Don Cristóbal Riquelme de Comontes, in 1558 through a letter of donation and *mejora* to his son Don Cristóbal Riquelme. The Riquelme family had other possessions in Coy like the *heredamiento* of the *chantre* of Santa Iglesia of Cartagena and the residence in Murcia of Don Pedro Hurtado de Mendoza (see figure 4.4). The lands were donated and given to Don Pedro Rodríguez de Avilés,

son of Don Diego Riquelme de Avilés and Doña Constanza de Bernal.

This set of territory was purchased from the *Santo Oficio* of the Inquisition, and it included water, paths, rivers, ways out and entries, uses, rights and serfdom practices that were in place before.<sup>28</sup> Water resources were essential, strategic areas within the descriptions of the lands, and regardless of the scarcity of water in some of these areas, prestigious, important individuals of Lorca's oligarchy were landowners there.<sup>29</sup> To expand their power, the Riquelme combined lands where the main water sources were located in Coy, regardless of their low quality, which in some instances limited cultivation and rotation. To own water in arid regions was 'at the same time a symbol of misery and wealth' – in periods of drought water sources were fundamental just for survival.<sup>30</sup>

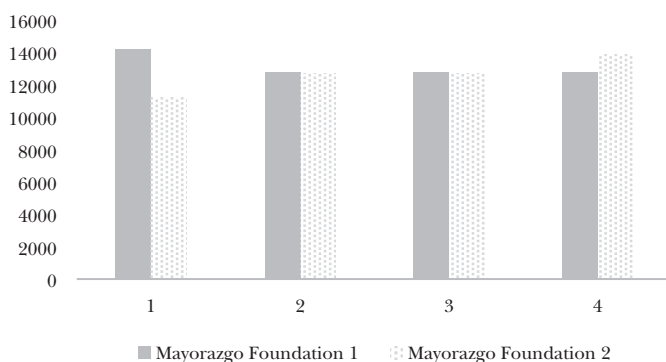

**Figure 4.5** Line of inheritance of the *mayorazgo* that Don Cristóbal de Arroniz, third lord of Santo Ángel, and Doña Nofra Riquelme founded, sixteenth to seventeenth centuries<sup>31</sup>

Santo Ángel and Campo Coy became one under the *mayoralazgo* of Don Cristóbal Riquelme y Arroniz, fifth lord of Coy and Sixth of Santo Ángel (see table 4.3 and figure 4.5), and also the main source of income for the Riquelme family. As such, to manage and own part of the *mayoralzgos* was a constant matter of discordant and conflictive relationships within the lineage. There were numerous judicial cases and lawsuits to control these lands, and increasingly so after the death of Cristóbal Riquelme y Arroniz's heir, his daughter Juana Riquelme. Generation after generation presented their cases and claims to be confirmed as legitimate owners and heirs of the *mayoralzgos* at the *Chancillería de Granada* and the *Consejo de Castilla*, and all the while the lands continued to be an extremely important source of wealth for the entire family (see table 4.4 and graph 4.1).

**Table 4.4** Income of lands under Don Cristóbal Riquelme y Arroniz, sixth lord of Santo Ángel<sup>32</sup>

Year	Income
1	11,724 <i>reales</i>
2	11,724 <i>reales</i>
3	11,724 <i>reales</i>
4	11,724 <i>reales</i>



**Graph 4.1** Income (in *reales*) of lands of two *mayoralzgos* under Juana Riquelme from year one to year four<sup>33</sup>

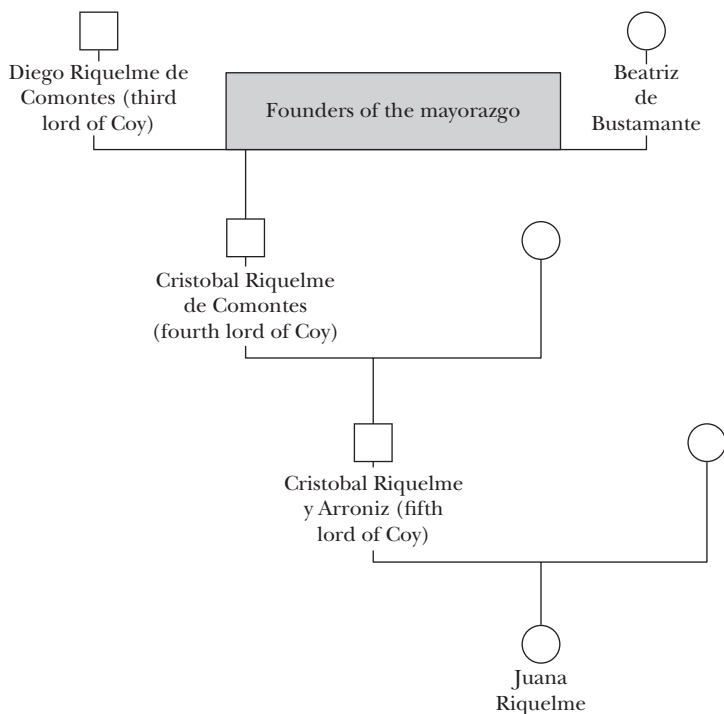

**Figure 4.6** Line of inheritance of the *mayoralzgo* that Don Diego Riquelme de Comontes, third lord of Coy, and Doña Beatriz Bustamante founded, sixteenth to seventeenth centuries<sup>34</sup>

Possessing land and its production was not only the oligarchy's means of survival, but also the most significant source of wealth in European pre-industrial societies and the most important source of power for the landowning nobility.<sup>35</sup> The Riquelme's corpus of lands, along with the peasants who worked them and paid for other usage rights, lay both in Murcia and outside the kingdom, and they were consolidated as a result of a strictly rigorous and diligent strategy of marriage alliances.

An example was the union between the Riquelme and the family name Muñoz de Robles. It began in 1621 when Juan Pedro Muñoz de Robles and María Riquelme de Arroniz, the daughter of Cristóbal Riquelme de Comontes (fourth lord of Coy) and of Antonia de Arroniz Riquelme, married (see figure 4.6).<sup>36</sup> The Riquelme

combined both *mayorazgos* with this marriage, the one that Pedro Muñoz founded in Caravaca in 1577, and the one that Juan de Robles started in 1557 (see figure 4.7 and 4.8).<sup>37</sup> Both *mayorazgos* gathered lands in Lorca, Campo Coy, where the Riquelme already had property, and in Caravaca, from where the family of Muñoz y Robles came. One marriage after another, the Riquelme ended up acquiring and extending patrimony through the formerly borderland region.

In Pedro Muñoz's foundation documents of his *mayorazgo*, he stated that Doña Isabel Muñoz, his daughter from his marriage with Francisca Calvetes, would be the first in the succession line to inherit the lands. Isabel was illegitimate, however, as she had been born when her parents were not yet married, and thus Pedro requested from the king a legitimization letter (provided in 1568) so that his daughter could inherit his possessions. The royal requests and all other strategies had to comply with the Muñoz's precedences – their commercial activities and professional positions as scribes or *procuradores* made them subject to accusations of being Jewish (explained before in chapter two). Another source of evidence for this is Pedro's foundational clauses that stated that Isabel had to marry 'a *hijodalgo* and person of pure blood'.<sup>38</sup> The best alternative to erasing these stains from the family name's memory was to marry into the Murcian elite. For social promotion, Muñoz individuals married members of the Riquelme family. In exchange, the Riquelme gained land patrimony in the Caravaca area and introduced family names that were in a phase of social ascension as part of their clientele. Land was a symbol of wealth; blood and honour conferred social status. Combined together they provided the oligarchy with an aura of power that translated into social and economic prestige: a symbolic capital that materialised in economic terms through the large returns that the lands generated.

Parents could also choose to confer social and economic status advancement to their children. Juan de Robles and Catalina Musso (in the Riquelme lineage) improved the status of their children in the collective will awarded in Caravaca on 15 November 1557. Their son, Juan de Robles, received an irrigated *heredad* and its house in Prados, Caravaca, from his father; the other child, Luis de Robles, received 1,000 *ducados* from the mother and lands that were his father's as well as three *fanegas* of *serrado* and a vineyard *heredad*.<sup>39</sup> An additional clause mentioned that the first to die left 1,000 *ducados* of *mejora* as well as a spiritual requirement always to

commemorate the souls of the parents Juan de Robles and Catalina Musso during each Christmas Day mass.

The *cobdicio* of Juan de Robles, signed in Caravaca on 1 September 1563, was even more explicit on this clause.<sup>40</sup> It required that in perpetuity, on all Fridays and Saturdays there was a mass or a mention in church of the souls of Juan de Robles, Catalina Musso and their parents. The charge of 30 *ducados* for these remembrances could be taken from the income their lands generated. Another mandate was to name a *capellán* of their blood, or if not of pure blood, showing how the foundation of *capellanías* that were pious memories linked in perpetuity to a group of properties, was a common practice and of great socioeconomic and religious value in the oligarchy.<sup>41</sup>

Both Pedro Muñoz's and Juan de Robles and Catalina de Musso's *mayorazgos* ended up in the hands of Juan Pedro Muñoz de Robles. When he married María Riquelme de Arroniz, the possessions were then inserted into the Riquelme lineage, on which this chapter will later focus as litigation around the *mayorazgos*, Juan Pedro and the Riquelme lineage became of great relevance. In this regard, it is

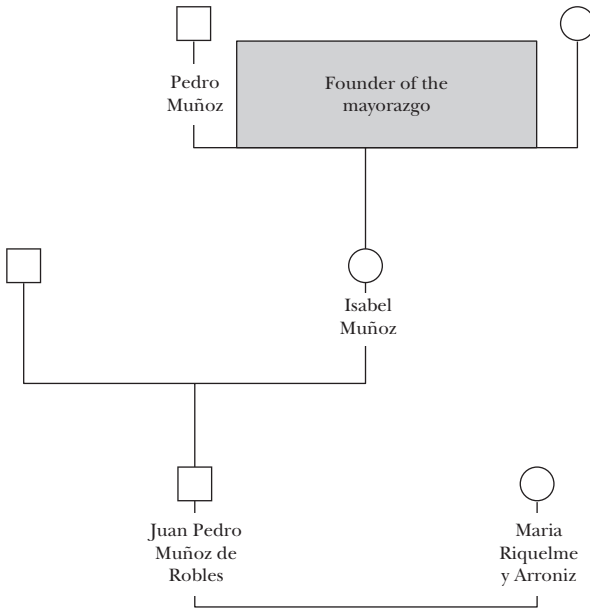

**Figure 4.7** Line of transfer of Pedro Muñoz's *mayorazgo*, sixteenth to seventeenth centuries<sup>42</sup>

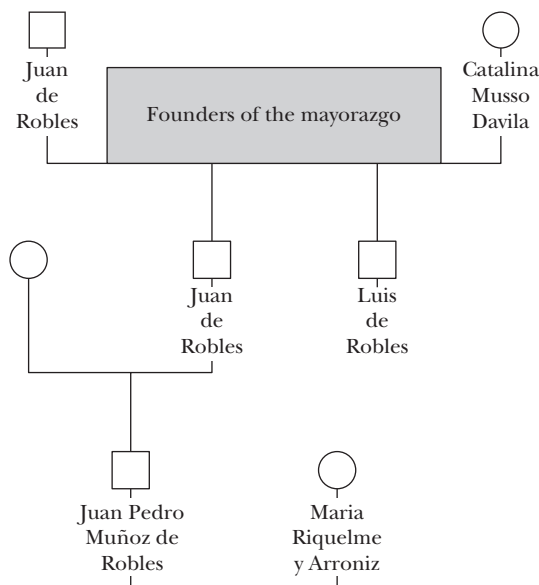

**Figure 4.8** Line of transfer of the *mayorazgo* that Juan de Robles and Catalina Musso Davila founded, sixteenth to seventeenth centuries<sup>43</sup>

**Table 4.5** Possessions in Pedro Muñoz's *mayorazgo*<sup>44</sup>

Property	Location
1 <i>bancal sembrado de trigo</i>	Orchard of Caravaca
104–5 <i>peonadas</i> of vineyards with trees and white irrigated and dry lands	Orchard of Caravaca
1 <i>heredad</i> of white and dry lands with their houses, farmyard and up to 3 <i>fanegas</i> cultivated irrigated and dry lands	District of Caravaca and city of Lorca ( <i>heredamiento</i> of Campo Coy)
1 <i>heredad</i>	District of Caravaca
1 <i>morenal</i>	Orchard of Caravaca
1 position of <i>Fiel Ejecutor</i> and trusted <i>regidor</i> to Francisco Muñoz	Caravaca
1 <i>heredad</i> of the heirs of Francisco Muñoz called 'el Campillo de Herranz'	Caravaca



**Table 4.6** Succession order that Pedro Muñoz's *mayorazgo* clauses established<sup>45</sup>

Succession order	Heir
1	Isabel Muñoz
2	Pedro Muñoz
3	Gonzalo Muñoz
4	Luis Muñoz
5	Pedro Muñoz
6	Sancho Muñoz
7	Alonso Muñoz
8	Catalina Musso
9	Aldonza de Villalta
10	Isabel Muñoz
11	Catalina Muñoz de Otálora ( <i>Señora de Cotillas</i> )
12	Beatriz Muñoz
13	Leonor Muñoz

important to note that the generations after Pedro Muñoz did not follow the line of transfer that he established as founder of the *mayorazgo*, even though it was mandatory and written in the clauses of the foundation to follow the founder's premises.

The line of succession was not fully respected. Catalina Musso, Juan de Robles's spouse and daughter of Pedro Muñoz, ended up receiving the *mayorazgo* and both groups' possessions, Muñoz's and Robles's, combined under the same family umbrella (see table 4.5 and 4.6). It was another instance of the *bucle matrimonial* practice, which enclosed both patrimonies under one family group.<sup>46</sup> Though such a transfer might have caused litigation among lineage members, there is no evidence that any of them, for the group's interest, resorted to the courts to solve the breach of the *mayorazgo* obligations.

There were other important lands located in the Orchard of Murcia that were attached to the *mayorazgos* which also followed the Valencian and Catalan oligarchic property model. The properties in the regions of La Ñora and Guadalupe were part of the *mayorazgo* that the *racioneros* and *canónigos* of the Cartagena cathedral, the brothers Luis and Macías Coque Riquelme had founded

on 15 January 1559.<sup>47</sup> To add to the bundle, Macías Coque had also founded a census-linked *capellanía*.<sup>48</sup> As they developed, *mayorazgos* in the region of Murcia followed the oligarchy's interests and tended to be different from the Castilian model, which did not allow linked properties to be in the census.

The trajectory of the *mayorazgo* that Macías Coque Riquelme received shows this pattern of the perpetuation of patrimony within the confines of the family and familial connections. He was the nephew of Luis and Macías Coque and son of Don Alonso Riquelme and Inés Coque, and he married Constanza Riquelme de Avilés. When Don Alonso Riquelme died in 1559 and Macías Coque Riquelme married Doña Constanza, the clergymen Macías and Luis Coque founded a new *mayorazgo*, but under the condition of being able to receive its income and forgo the *legítimas materna* and *paterna* in favour of Macías's brother and *regidor*, Bernardino Riquelme. Bernardino received another linked property from his brother and *arcediano* of the Cartagena church, Fabricio Riquelme.<sup>49</sup> All these transactions and mechanisms, used to build up kinship and lineage, also contributed to perpetuating and reproducing the ideals that were the common denominator of the traditional Castilian elite.<sup>50</sup> The accumulation of patrimony started with the family (and in relation to other families) as the central structure, travelled within the family, following a horizontal line through siblings and vertical descendants through uncles and aunts and nephews and nieces, and stayed in the family.

Marriage alliances were thus fundamental to the Riquelme lineage, and to the oligarchy in general, to consolidate socio-economic power and increase their wealth. Another example was the connection with the Almela y Tomás families through the marriage of Cristóbal Riquelme Muñoz de Robles, son of María Riquelme y Arroniz and Juan Pedro Muñoz de Robles, to Francisca Almela y Tomás, daughter of Pablo Fulgencio de Almela y Junco and Laura Fontes y Avilés, in the mid-sixteenth century.<sup>51</sup> For the couple, Doña Francisca of the Riquelme lineage negotiated the merger of the *mayorazgo* that Don Juan de Junco (treasurer of the *Santo Oficio* and *regidor* of Murcia) and his spouse Doña Francisca Ballester, residents of Murcia, founded on 3 July 1627 (see figure 4.9). The same happened with the *mayorazgos* of Diego Tomás de Oluja, knight of Alcántara, founded around the same time, and the one that Doña Fabiana Salad y Anduga and Alonso Almela y Arroniz, knight of Calatrava's spouse, also residents of Murcia founded in January 1622 (see figure 4.10).<sup>52</sup>

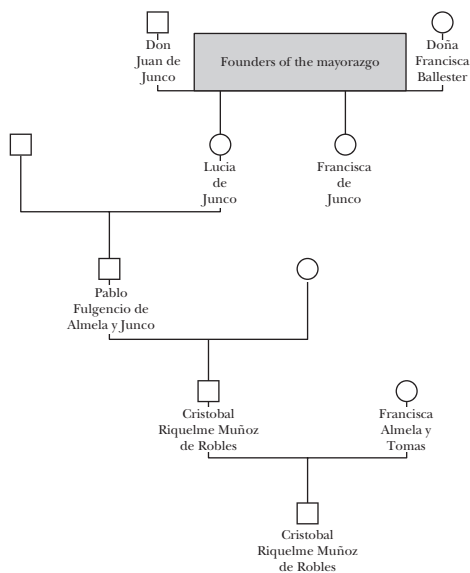

**Figure 4.9** Line of transfer of the *mayoralzgo* of Don Juan de Junco and Doña Francisca Ballester, seventeenth century<sup>53</sup>

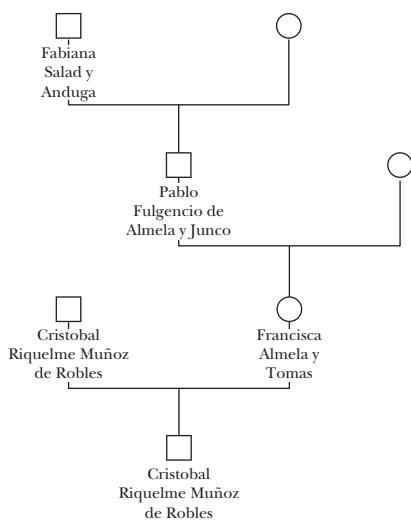

**Figure 4.10** Line of transfer of the *mayoralzgo* of Doña Fabiana Salad y Anduga, seventeenth century<sup>54</sup>

Table 4.7 Censuses

<i>Censatario</i>	Vicinity	Value	<i>Censatario</i>	Value	Vicinity	Value
Andrés Martínez Márquez y Lorenzo	Murcia	60 <i>ducados</i>	Juan Barnuevo		Murcia	1,474 <i>ducados</i>
Agustín de Martínez Juan Vicente	Murcia	56 <i>ducados</i>	B. de Aranda		Murcia	50 <i>ducados</i>
Francisco de Carvajal	Murcia	30 <i>ducados</i>	Gerónimo de Jumilla		Murcia	224 <i>ducados</i>
Doña Catalina Jurado de Mendoza	Murcia	56 <i>ducados</i>	Francisco de Balbrera		Murcia	224 <i>ducados</i>
Jusepe Domínguez (scribe of Córdoba)	Córdoba	98 <i>ducados</i>	E. Salad Jurado Hernando de Saavedra		Murcia	140 <i>ducados</i>
Pedro Ussodemar ( <i>regidor</i> of Murcia)	Murcia	210 <i>ducados</i>	Doña Mariana Ibañez		Murcia	112 <i>ducados</i>
Ginés García 'el viejo' and Ginés García, his son	Murcia	98 <i>ducados</i>	Doña. Juan Jiménez, Duque Francisco García		Murcia	100 <i>ducados</i>
Francisco Ponce	Murcia	140 <i>ducados</i>	Doña Beatriz [surname?]		Murcia	600 <i>ducados</i>
Miguel de Almodóvar	Murcia	112 <i>ducados</i>	Salvadora Tomás, spouse of Gil Guzmán		Murcia	140 <i>ducados</i>
Damián Mesas	Murcia	256 <i>ducados</i>	Juan de [surname?]		Murcia	112 <i>ducados</i>
Cristóbal Barrancos	Murcia	28 <i>ducados</i>	Juan de Quirós		Murcia	55 <i>ducados</i>

Table 4.7 Censuses (Continued)

<i>Censatario</i>	<b>Vicinity</b>	<b>Value</b>	<i>Censatario</i>	<b>Vicinity</b>	<b>Value</b>
Gerónimo Alcázar	Murcia	140 <i>ducados</i>	Doña Ana, Jumilla y Francisco [surname?]	Murcia	168 <i>ducados</i>
Juan de Arcaya (captain)	Murcia	98 <i>ducados</i>	Juan de Aullón	Murcia	50 <i>ducados</i>
Tomás Muñoz Rodrigo Avellaneda	Murcia	308 <i>ducados</i>	Francisco Fernández	Murcia	100 <i>ducados</i>
Hernando Serrano	Murcia	100 <i>ducados</i>	Guillén [surname?]	Murcia	40 <i>ducados</i>
Pascual Real	Murcia	140 <i>ducados</i>	Andrés Hernández y Jurado	Murcia	300 <i>ducados</i>
Juan de [surname?]	Murcia	350 <i>ducados</i>	Andrés Hernández y Jurado	Murcia	300 <i>ducados</i>
Juan Barnuevo	Murcia	50 <i>ducados</i>	Ginés Guillén	Murcia	200 <i>ducados</i>

**Table 4.8** Land properties

Unit of measurement	Location
2 <i>tahúllas</i> and 3 <i>brazas</i> of <i>moreral</i> land owned by Doña Catalina de Roda	Orchard of Murcia, Pago de Seca
1 <i>tahúlla</i> , 3 <i>cuartas</i> and 14 <i>brazas</i> of <i>moreral</i> land	Pago of Seca
3.25 <i>tahúllas</i> and 13 <i>brazas</i> of vineyards	Orchard of Murcia, Pago of Albadel and the mill owned by the king and Doña Leonora de Perea
6 <i>tahúllas</i> and 5 <i>brazas</i> of vineyards	Pago of Albadel
5 <i>tahúllas</i> , 1 quarter and 16 <i>brazas</i> of <i>moreral</i> land of Don Ginés Rocamora	Pago of Alfande

#### 4.1.1.1. Riquelme-Fontes: Wealth Accumulation through Antonio Fontes Paz (third marquis of Torre Pacheco)

The union with the Fontes lineage was without a doubt the most profitable one for the Riquelme group. Several *mayorazgos* ended up under the Riquelme name through marriages with the Fontes families and also through other indirect connections with this family name. Don Antonio Fontes Paz, third marquis of Torre Pacheco, was at the centre of many of the unions between both families, making possible most of their patrimony accumulation from the sixteenth to the eighteenth centuries. Particularly, the marriage between Don Antonio Fontes Paz and Doña Francisca Riquelme y Buendía, and their heir Joaquín Fontes Riquelme, fourth marquis of Torre Pacheco, marked the beginning of the accumulation of a large group of properties under the Riquelme family.<sup>55</sup> Examples of patrimonies coming together in the period were the *mayorazgo* (founded in February, 1538) of residents of Murcia Don Diego Riquelme de Avilés and his spouse Doña Constanza de Bernal, which their first-born, Gonzalo Rodríguez de Avilés, inherited and combined with the large patrimony of Doña Isabel Fontes (see figure 4.11). Gonzalo's brother, Pedro Rodríguez de Avilés, received the *mayorazgo* that Don Pedro Hurtado de Mendoza (*chantre* of the cathedral) founded in 1558 (see figure 4.12). Also, Onofre Fontes de Albornoz and his spouse

Doña Isabel Pagán Riquelme founded a *vínculo* and a *mayorazgo* for their son, Don Baltasar Fontes de Albornoz, in 1593 (see figure 4.13 and table 4.9).<sup>56</sup>

Founding *mayorazgos* provided great authority over the land, and founders of the agglomerations of territories rigorously scheduled its distribution, what was to be built on the land and the official positions to be created in that space. The *mayorazgo* that Don Alonso de Paz founded for his son Don Alonso de Paz in the *villa* of Frejenal in 1597, where he also founded the *Colegio de*

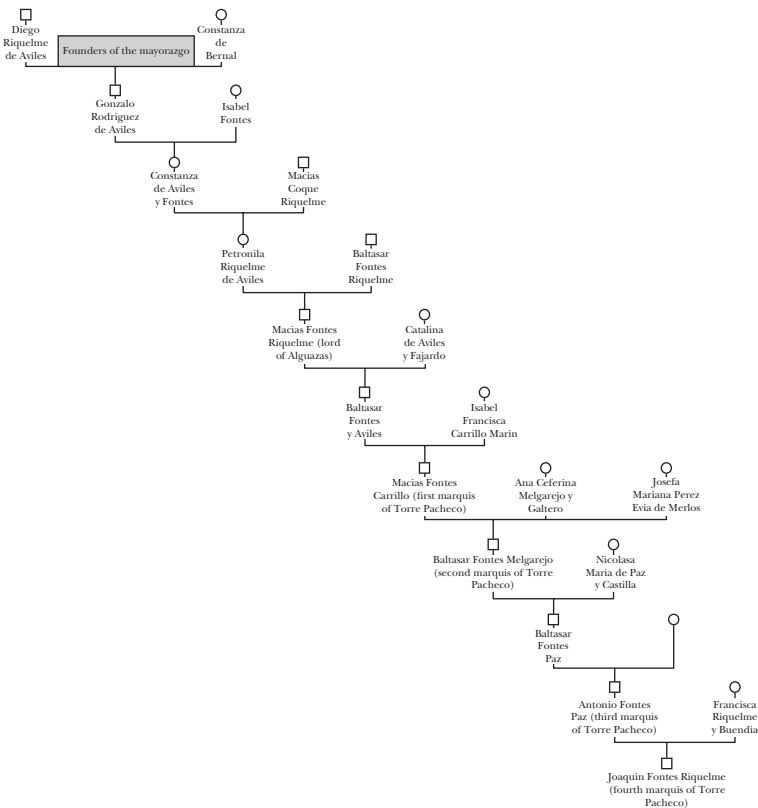

**Figure 4.11** Line of transfer of the *mayorazgo* of Don Diego Riquelme de Avilés and Doña Constanza de Bernal, sixteenth to nineteenth centuries<sup>57</sup>

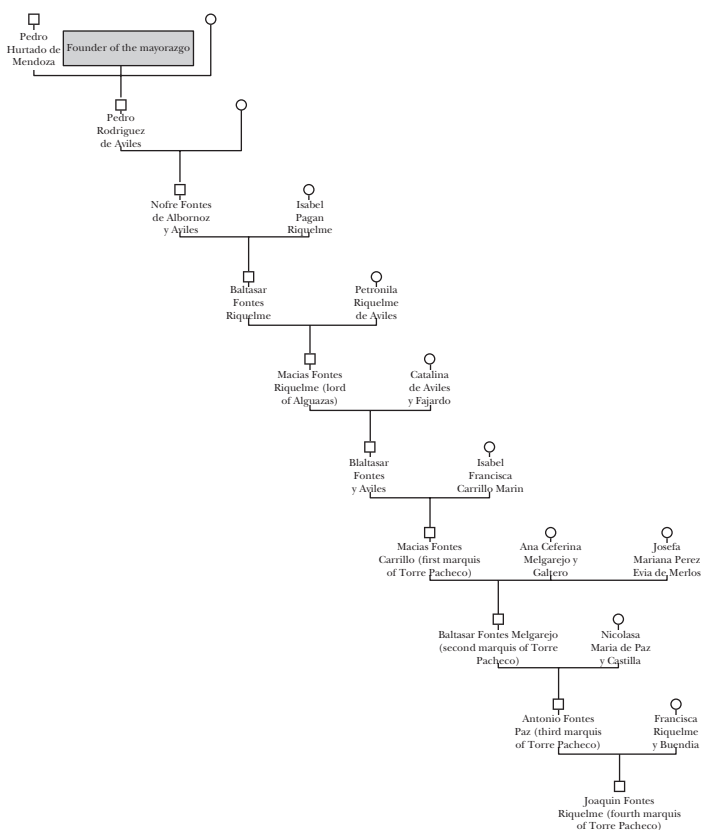
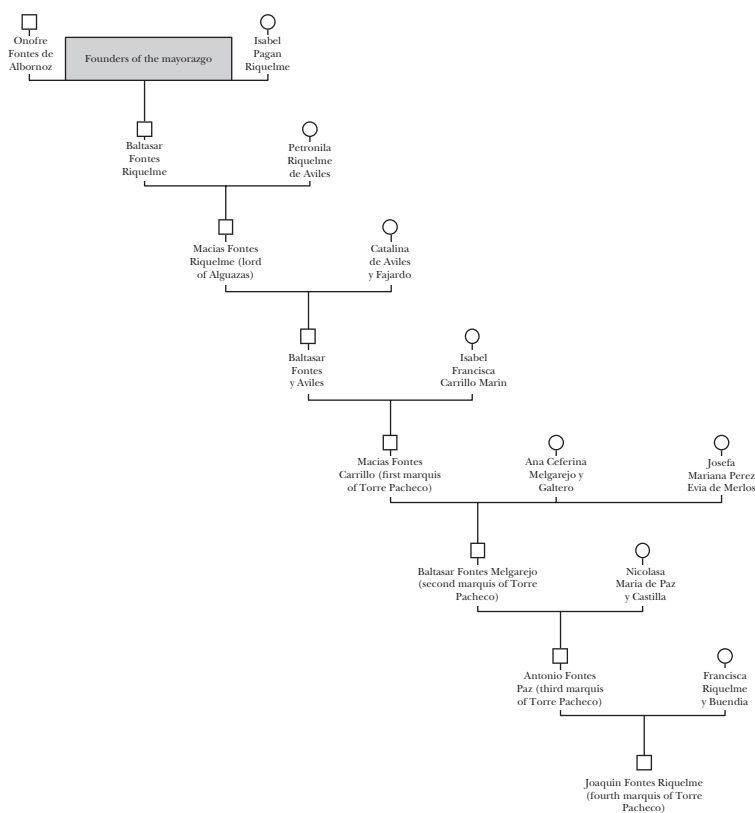

**Figure 4.12** Line of transfer of the *mayorazgo* of Don Pedro Hurtado de Mendoza, sixteenth to nineteenth centuries.<sup>58</sup>

**Table 4.9** Properties in the *mayorazgo* that Don Onofre Fontes de Albornoz and Doña Isabel Pagán Riquelme founded<sup>59</sup>

Property	Place	Value
Main houses	Parish of Santa María (Murcia)	64,4810 <i>reales</i>
1 <i>heredad</i> with houses, wells, oxen and <i>aderezos</i>	Campo de Cartagena	70,000 <i>ducados</i>
8 <i>tahúllas</i> and <i>cuarta</i> and a half, minus 8 brazas in 4 <i>bancales</i>	<i>Pago</i> of Argualejo (Hoya de Baños)	360,824 <i>reales</i>





**Figure 4.13** Line of transfer of the *mayorazgo* that Don Onofre Fontes de Albornoz and Doña Isabel Pagán Riquelme founded, sixteenth to nineteenth centuries<sup>60</sup>

*la Compañía de Jesús* (Society of Jesus College) and two *capellanías* on the monastery of Nuestra Señora de la Paz de Frejenal, was also part of this group of patrimonial land that the Riquelme lineage eventually accumulated.<sup>61</sup> The three *mandas pías* (pious mandates) received 1,000 *ducados* a year to spend on wheat and salaries, and 500 *ducados* that each year for twenty years should be donated to the colleges and seminaries of Seville and Valladolid. The founder also decided who had the power to name positions – he ordered his son Alonso de Paz to name the founder’s brother *licenciado* Francisco Rodríguez de Paz the *capellán*, for example.

The stipulations that founders of *mayorazgos* provided reinforced their power and memory through generations, and in the case of the Paz family, the creation of Catholic institutions in Frejenal de la Sierra (Extremadura) and other patronage campaigns helped erase their possible connection with Jewish communities that once lived in the area.

Antonio Fontes Paz ended up inheriting the *mayorazgo* after the union of the Fontes and the Paz families (see figure 4.14), who socialised with other members of the oligarchy in the *villa* and royal court of Madrid.<sup>62</sup> It was one of the most significant examples of patrimony within the Riquelme-Fontes, with *juros*, *censo*s and high tributes such as commercial taxes like the *almojarifazgo* on sales and purchases (*alcabalas*) and important incomes such as the marquis of Pliego's *mayorazgo*.<sup>63</sup> The entire dominion covered the diverse territories of the jurisdiction of the district of Seville (see table 4.10).

The *mayorazgos* of the Rocamora family, one of the most important oligarchic Valencian families, and other illustrious names of Orihuela in the kingdom of Valencia, also came under the

**Table 4.10** Properties of the *vínculo* that Don Alonso de Paz founded<sup>64</sup>

*Annual Juros*

<b>Juros</b>	<b>Location</b>	<b>Value</b>
1 <i>Juro</i> over the <i>Almojarifazgo de Indias</i>	Seville	326,096 <i>reales</i>
1 <i>Juro</i> over the <i>Almojarifazgo de Indias</i>	Seville	200,000 <i>reales</i>
1 <i>Juro</i> over the <i>Almojarifazgo de Indias</i>	Seville	200,000 <i>reales</i>
1 <i>Juro</i> over the <i>Almojarifazgo de Indias</i>	Seville	200,000 <i>reales</i>
1 <i>Juro</i> over the <i>Almojarifazgo de Indias</i>	Seville	796,000 <i>reales</i>
1 <i>Juro</i> over the <i>Almojarifazgo de Indias</i>	Seville	93,750 <i>reales</i>
1 <i>Juro</i> over the <i>Almojarifazgo mayor</i>	Seville	14,000 <i>reales</i>
1 <i>Juro</i> over the <i>Almojarifazgo mayor</i>	Seville	75,000 <i>reales</i>
1 <i>Juro</i> over the <i>Almojarifazgo mayor</i>	Seville	56,250 <i>reales</i>
1 <i>Juro</i> over the <i>Alcabalas</i>	Málaga	120,500 <i>reales</i>
1 <i>Juro</i> over the <i>Alcabalas</i>	Jerez de los Caballeros	100,000 <i>reales</i>

**Table 4.10** Properties of the *vínculo* that Don Alonso de Paz founded<sup>64</sup>  
(Continued)

<i>Annual Tributes</i>		
<b>Tributos</b>	<b>Location</b>	<b>Valor</b>
1 <i>Tributo</i> from the duke of Medina Sidonia		164,062.5 <i>reales</i>
1 <i>Tributo</i> from the duke of Medina Sidonia		164,062.5 <i>reales</i>
1 <i>Tributo</i> over personal properties and incomes	Seville	400,000 <i>reales</i>
1 <i>Tributo</i> over the properties of Cristóbal García Benjumea and Juana González, Gabriel de Benjumea, Ana Valbuena and sisters	Villa de Lajapal	53,500 <i>reales</i>
1 <i>Tributo</i> over the marquisate of Pliego	Pliego	209,427 <i>reales</i>
1 <i>Tributo</i> over the marquisate of Pliego, its estate and <i>mayorazgo</i>	Pliego	441,176 <i>reales</i>
1 <i>Tributo</i> over the properties of Constanza de Arauz, of Alonso de Arauz (knight of Cazalla), and of María de Martínez	Cazalla	10,714 <i>reales</i>
1 <i>Tributo</i> over the estate's properties and <i>mayorazgo</i> of Don Hernando Enriquez de Ribera (marquis of Villanueva del Río)	Villanueva del Río	563,014 <i>reales</i>

Riquelme-Fontes dominion. The Paz and the Rocamora examples demonstrate one more time how rigorous marriage strategies were when the most important goal was to increase and strengthen the socioeconomic power of the lineage. Don Jaime de Rocamora, born and resident of Orihuela, founded a *mayorazgo* in favour of his daughter Doña Isabel de Rocamora y Ruíz on 22 June 1612 (see figure 4.15 and table 4.11). The family owned a *capellanía* in the parish of Santa Justa y Rufina, with an altar to San Nicolás de Bari.<sup>65</sup>

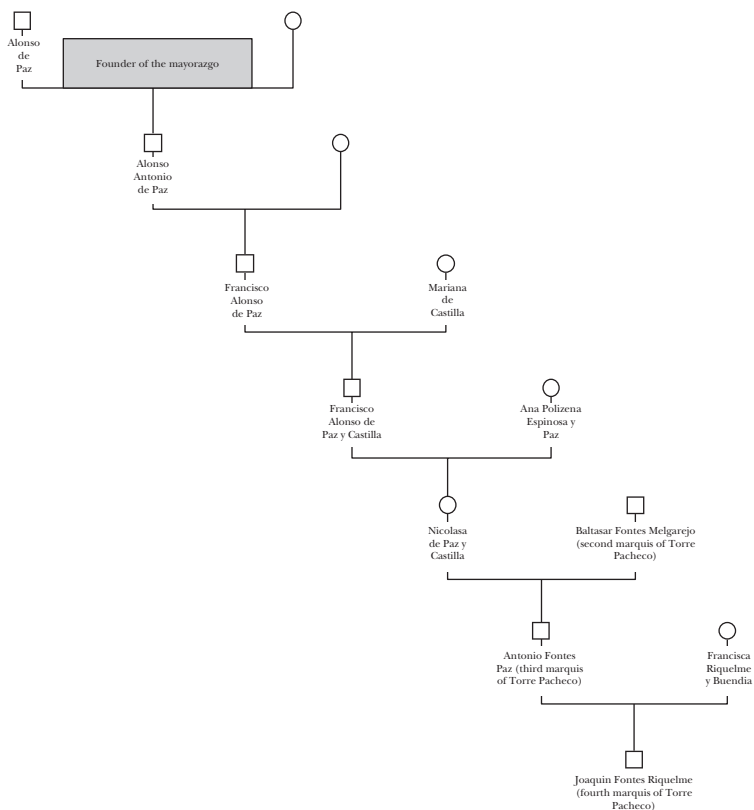

**Figure 4.14** Line of transfer of the *mayorazgo* that Don Alonso de Paz founded, sixteenth to nineteenth centuries<sup>66</sup>

**Table 4.11** Properties of the *mayorazgo* founded by Don Jaime Rocamora<sup>67</sup>

Properties	Location
Main houses	Parish of Santa Justa y Rufina (Orihuela)
1 <i>heredad</i> of white lands, <i>morerales</i> and vineyards and other trees in 450 <i>tahúllas</i> of irrigated lands	Orihuela
1 <i>heredad</i> of <i>cañadas</i> , <i>morerales</i> and dry lands called La Rambla	<i>Partida</i> of Alpater (Orihuela)

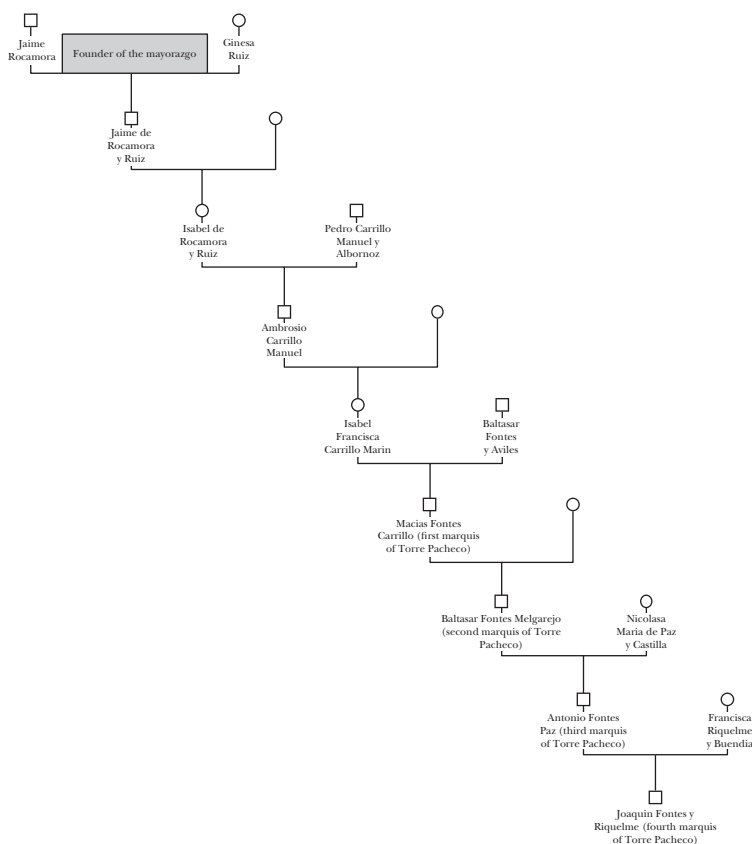

**Figure 4.15** Line of transfer of the *mayorazgo* that Don Jaime de Rocamora founded, sixteenth to nineteenth centuries<sup>68</sup>

Doña Ana de Moya, resident and *regidor* of Caravaca and Don Diego Melgarejo Riquelme's spouse, founded a *mayorazgo* (see figure 4.16) with properties of the *heredad* of the Moral's fountain in 1629 for her son Don Francisco Muñoz Melgarejo (*alférez mayor* of Caravaca).<sup>69</sup> After a transfer of properties of the *mayorazgo* of Macías Fontes, first marquis of Torre Pacheco's spouse Doña Ana Melgarejo, it all came into the ownership of the marquises of Torre Pacheco.<sup>70</sup>

On 21 January 1631, Don Juan Damián de la Peraleja, a resident of Murcia, founded a *mayorazgo* in favour of his granddaughter Doña Dionisia Galtero, married to Don Diego Melgarejo de Mora, and the

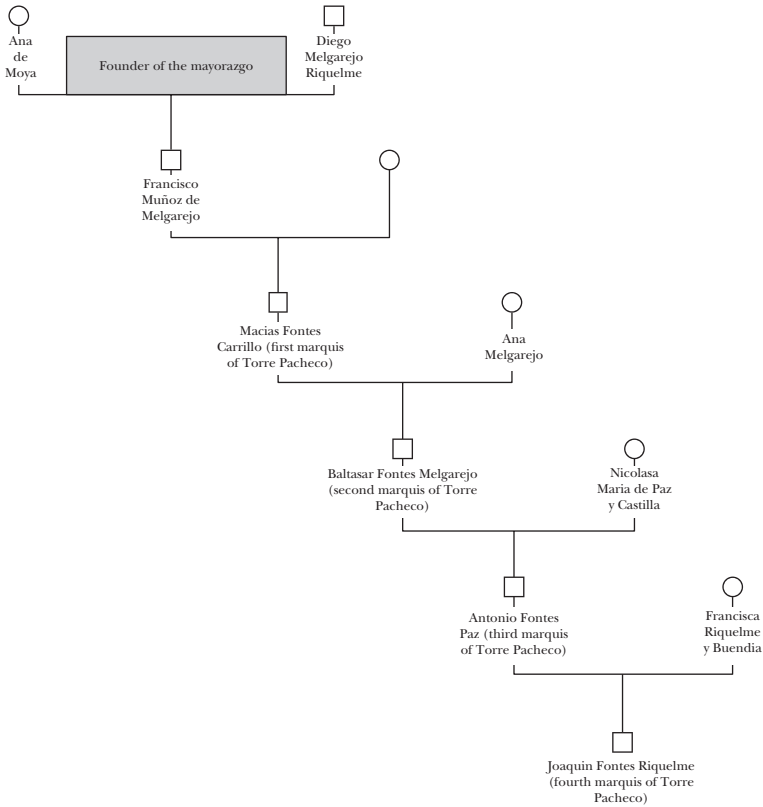

**Figure 4.16** Line of transfer of the *mayorazgo* that Doña Ana de Moya founded<sup>71</sup>

daughter of Doña María de la Peraleja and Don Diego Martínez Galtero Melgarejo.<sup>72</sup> This group of properties from the Peraleja family, located in the Orchard of Murcia, also ended up under the Riquelme-Fontes as a result of the marriage between the daughter of Dionisia Galtero and Diego Melgarejo, Ana Ceferina Melgarejo y Galtero, to Macías Fontes Carrillo (first marquis of Torre Pacheco).

Not very long after the foundation of the Peraleja *mayorazgo* (see figure 4.17, 4.18 and table 4.12), Don Juan Damián de la Peraleja's brother, Don Antonio de la Peraleja (knight of Alcántara and *regidor* of Murcia), in his testament of 1655, added a new group of properties

**Table 4.12** Properties in the *mayorazgo* of Don Juan Damián de la Peraleja<sup>73</sup>

Property	Location	Value
1 <i>heredad</i> with <i>moreras</i> and a group of orange trees of 54 <i>tahúllas</i>	<i>Pago</i> of Puente del Moro (Orchard of Murcia)	
1 <i>heredad</i> of 4 <i>cuartos</i> of irrigated lands with corresponding dry lands	<i>Heredamiento</i> of Sangonera (Orchard of Murcia)	
1 contract of census done and paid by Juan de Yepes Saavedra ( <i>jurado</i> of Murcia)'s wife, with a pension to be provided to Doña Beatriz de la Peraleja (sister of Juan Damián)	Murcia	1,400 <i>ducados</i>

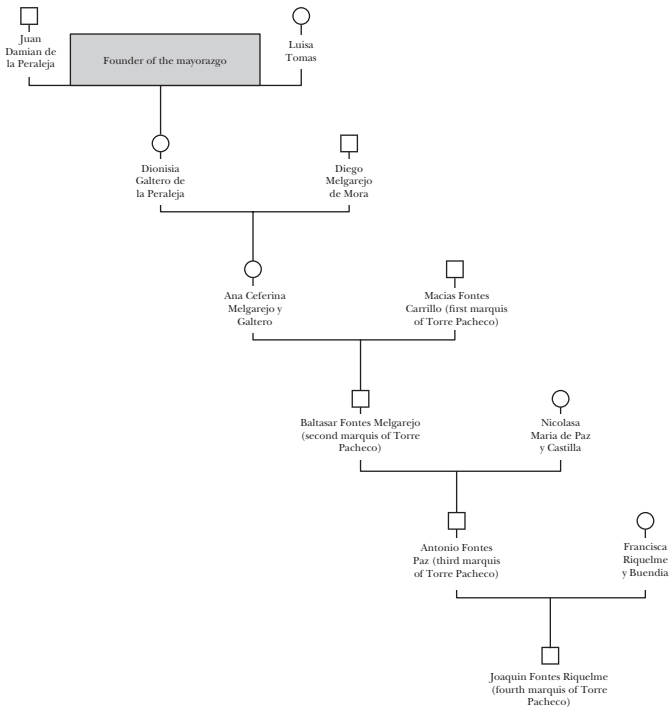
**Figure 4.17** Line of transfer of the *mayorazgo* that Don Juan Damián de la Peraleja founded, seventeenth to nineteenth centuries<sup>74</sup>

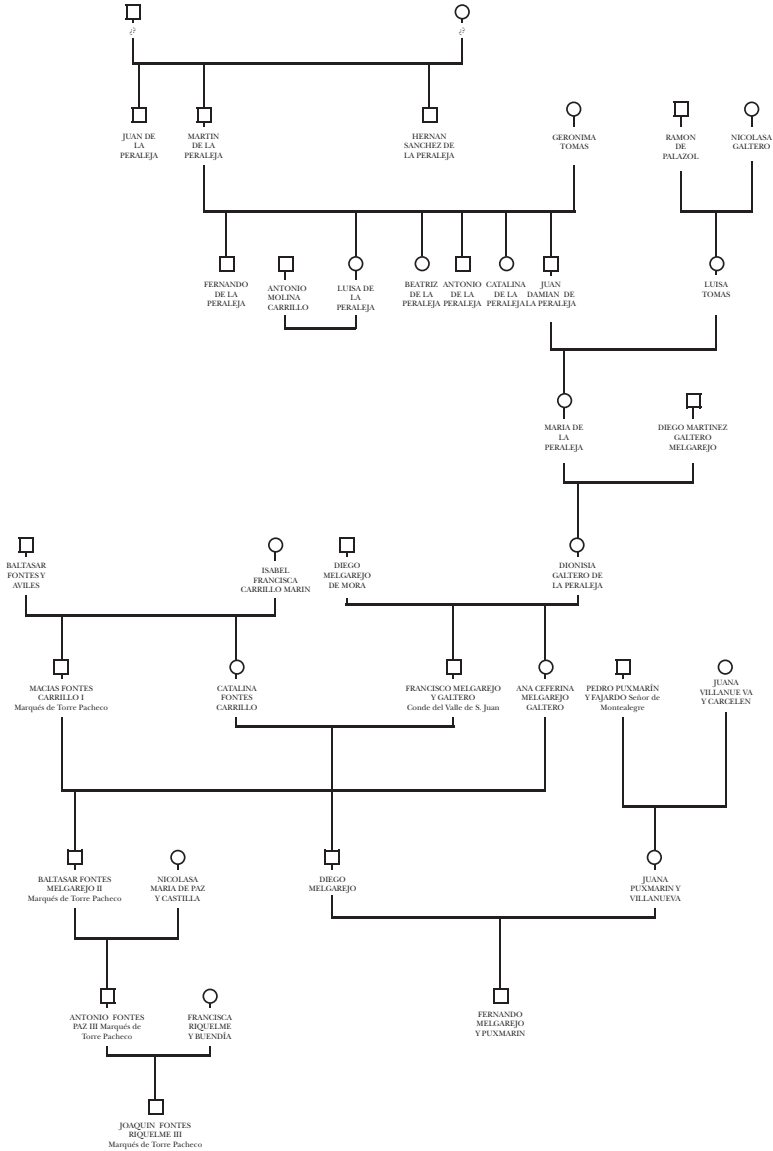
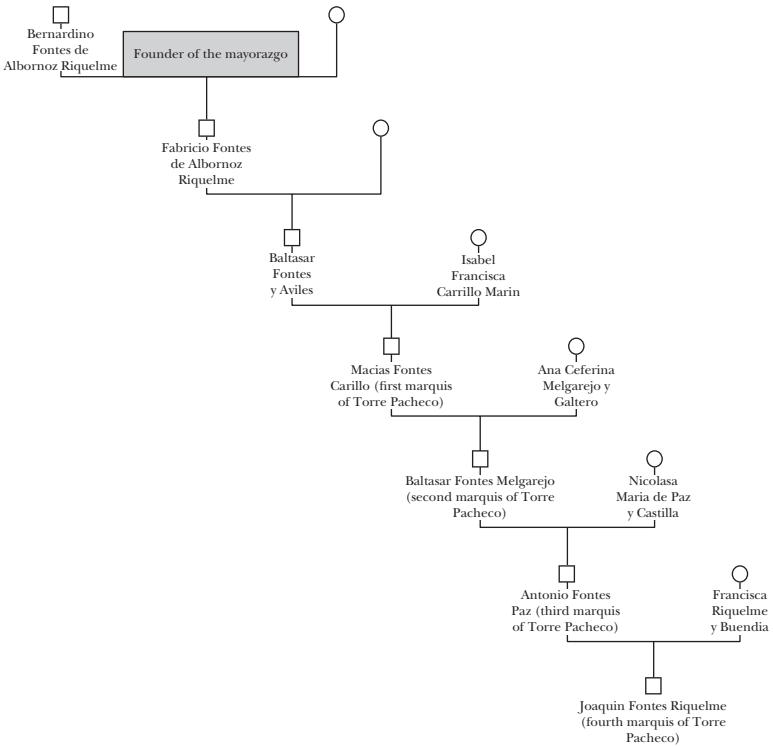

Figure 4.18 Riquelme-Fontes genealogy and links with the Peraleja family, sixteenth to nineteenth centuries<sup>75</sup>



(three-quarters of water and lands from the *heredamiento* of Sangonera la Verde) to the *vínculo*.<sup>76</sup> Another *mayorazgo* worth mentioning is the one that Don Bernardino Fontes de Albornoz Riquelme (see figure 4.19), a resident of Murcia and *canónigo* of the cathedral, founded in his will of 1642, which linked all the properties (one *heredad* in the *Pago* de Churra with *morerales* or mulberry trees, vineyards, houses, palaces and the rest in 100 *tahúllas*) to his brother Don Fabricio Fontes de Albornoz Riquelme.<sup>77</sup>

Furthermore, Don Macías Fontes Carrillo, first marquis of Torre Pacheco, who had already caused all the *mayorazgos* to end up in the hands of his first-born, Baltasar Fontes Melgarejo, second marquis of Torre Pacheco, advanced his son's status even more by founding a new *vínculo* in 1702 (see table 4.13 and figure 4.20).<sup>78</sup>



**Figure 4.19** Line of transfer of the *mayorazgo* that Don Bernardino Fontes de Albornoz Riquelme founded, seventeenth to nineteenth centuries<sup>79</sup>

**Table 4.13** Properties in the *mayorazgo* of Don Macías Fontes Carrillo (first marquis of Torre Pacheco)<sup>80</sup>

Property	Place	Value
Los Lázaros's main houses	<i>Placeta</i> of Fontes, parish of Santa María (Murcia)	33,709 <i>reales</i>
18 <i>tahúllas</i> , 1 <i>cuarta</i> of <i>morerales</i> lands	<i>Pago</i> of Argualeja (Orchard of Murcia)	
5 <i>tahúllas</i> , 3 <i>cuartas</i> and 4 <i>brazas</i> of white lands in 3 <i>bancales</i>	<i>Pago</i> of Argualeja (Orchard of Murcia)	
Castile title of marquis of Torre Pacheco bought from the dean and <i>cabildo</i> of the cathedral	Murcia	
1 closed orchard of <i>tapias</i> with a tower, fruit trees with 8 <i>tahúllas</i>	<i>Pago</i> of Zaraychico of the <i>acequia</i> of Zaráiche el grande (Orchard of Murcia)	
4 <i>tahúllas</i> , 1 <i>ochaba</i> and 24 <i>brazas</i> of white land with some <i>moreras</i>	<i>Pago</i> of Arboleja (Orchard of Murcia)	114,750 <i>reales</i>
1 <i>bancal</i> of white land with some <i>moreras</i> and one house with 4 <i>tahúllas</i> , 6 <i>ochabas</i> and 5 <i>brazas</i>	<i>Pago</i> of Arboleja (Orchard of Murcia)	129,731 <i>reales</i>
1 <i>bancal</i> of white land with some <i>moreras</i> of 8 <i>tahúllas</i> , 3 <i>ochabas</i> and 25 <i>brazas</i>	<i>Pago</i> of Arboleja (Orchard of Murcia)	253,493 <i>reales</i>
1 <i>bancal</i> of white land with some <i>moreras</i> of 1 <i>tahúlla</i> and 5 <i>ochabas</i>	<i>Pago</i> of Arboleja (Orchard of Murcia)	38,675 <i>reales</i>
2 <i>tahúllas</i> , 1 <i>ochaba</i> and 2 <i>brazas</i> of <i>bancal</i> land with <i>moreral</i> that has 11 <i>tahúllas</i> , 1 <i>ochaba</i> and 2 <i>brazas</i>	<i>Pago</i> of Arboleja (Orchard of Murcia)	72,382 <i>reales</i>

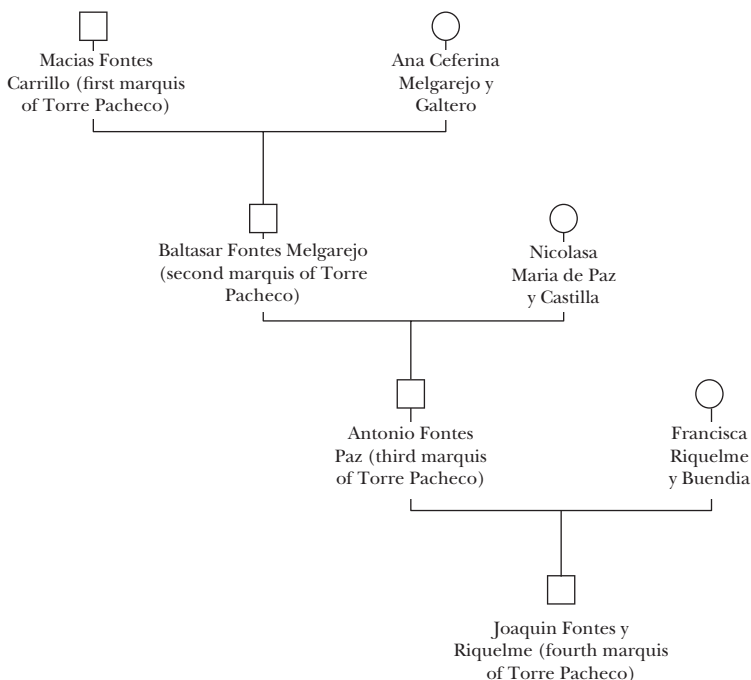

**Figure 4.20** Line of transfer of the *mayorazgo* that Don Macías Fontes Carrillo, first marquis of Torre Pacheco, founded, seventeenth to nineteenth centuries<sup>81</sup>

Don Alejandro Fontes, Baltasar Fontes Melgarejo (second marquis of Torre Pacheco)'s brother, founded on 1 November 1718 a valuable *mayorazgo* to be transferred to his son Baltasar Fontes Paz.<sup>82</sup> When Baltasar died in February 1757, his brother Antonio (third marquis of Torre Pacheco) inherited it. With lands in the Orchard of Murcia and in the *villa* of Archena, and later with more aggregations, it became one of the most profitable lands for the Riquelme-Fontes lineage (see figure 4.21 and table 4.14 and 4.15).<sup>83</sup>

The last link in the line of descendants of the marquises of Torre Pacheco was the *mayorazgo* that Juan Marín Blázquez founded for his eldest son, Don Juan Marín Blázquez de Valdés in 1599 (see table 4.16).<sup>84</sup> The line of transfer that made this *vínculo* come under the Riquelme-Fontes lineage is unclear, but most likely it was from the union of the Fontes family with the Carrillo Marín surname,

**Table 4.14** Properties in the *mayorazgo* of Don Alejandro Fontes<sup>85</sup>

Property	Location	Income from renting
27 <i>tahúllas</i> , 5 <i>ochabas</i> , 20 <i>brazas</i> of <i>morerales</i> and white lands with houses and 2 palaces <i>tejados</i>	<i>Pago</i> of La Algaida ( <i>villa</i> of Archena)	3,000 <i>reales</i>
Main house, orchard and Las Bombas garden	Murcia	600 <i>reales</i>
7 <i>tahúllas</i> , 4 <i>ochabas</i> , 7 <i>brazas</i> of <i>morerales</i> and white lands	<i>Pago</i> of the Rincón de la Ñora (Orchard of the <i>villa</i> of Alcantarilla)	270 <i>reales</i>
14 <i>tahúllas</i> , 3 <i>ochabas</i> , 24 <i>brazas</i> of <i>morerales</i> and white lands	<i>Riego de la acequia de Afalejo</i> , <i>Pago</i> of Bendame (Orchard of Murcia)	500 <i>reales</i>
8 <i>tahúllas</i> , 6 <i>ochabas</i> and 20 <i>brazas</i> of <i>morerales</i>	<i>Pago</i> of Zaráiche y Zaraychico (Orchard of Murcia)	
2/3 of an inhabitable house	<i>Villa</i> of Villanueva	Ruined, no income
1 <i>cañada</i> of dry lands and 6 <i>fanegas</i> lands with olive, fig and other trees	<i>Partido</i> of Algaida and <i>Pago</i> of the Gordo ( <i>villa</i> of Archena)	300 <i>reales</i>

**Table 4.15** Additions to the *mayorazgo* of Don Alejandro Fontes<sup>86</sup>

Property	Location	Value
1 <i>cuadrón</i> of <i>moreral</i> of 16 <i>tahúllas</i> , 6 <i>ochabas</i> and 24 <i>brazas</i>	<i>Pago</i> of Beniscornia (Orchard of Murcia)	20,212 <i>reales</i>
1 <i>cuadrón</i> of <i>moreral</i> of 10 <i>tahúllas</i> , 3 <i>ochabas</i> and 24 <i>brazas</i>	<i>Pago</i> of Beniscornia (Orchard of Murcia)	13,609 <i>reales</i> and 12 <i>maravedís</i>
2 <i>barracas</i> of 3 <i>andanas</i>	<i>Pago</i> of Beniscornia (Orchard of Murcia)	500 <i>reales</i>

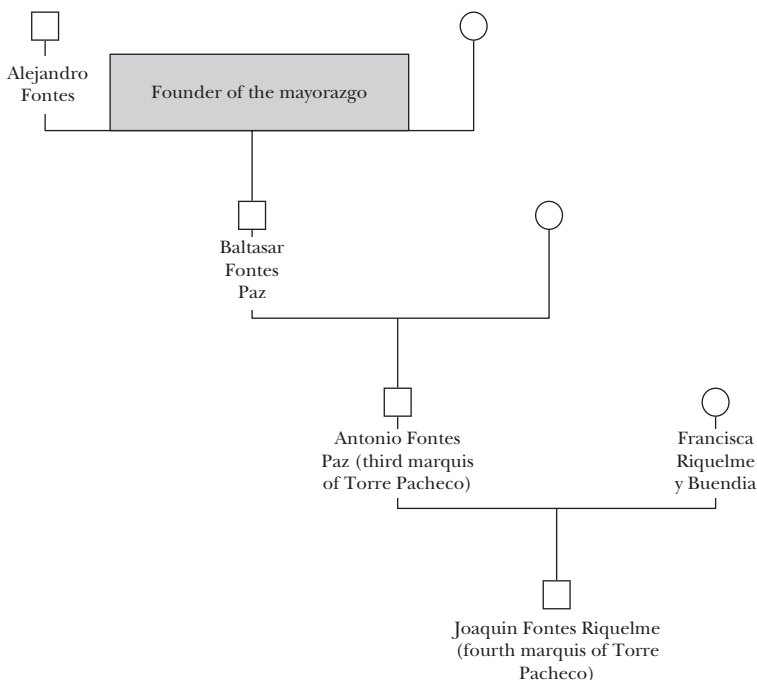

**Figure 4.21** Line of transfer of the *mayoralzgo* that Don Alejandro Fontes founded<sup>87</sup>

**Table 4.16** Properties in the *mayoralzgo* of Don Juan Marín Blázquez<sup>88</sup>

Properties	Location
87 <i>tahúllas</i> of <i>moreal</i> lands with a piece of white land and some main houses, one palace, one ruined chapel with 4–5 more plots for other palaces	<i>Pago</i> of Benefiar (Orchard of Murcia)
6.5 <i>tahúllas</i> of <i>moreal</i> lands close to those houses	<i>Pago</i> of Benefiar (Orchard of Murcia)
34 <i>tahúllas</i> of vineyards and white land, a piece of <i>moreal</i> , close to those houses	<i>Pago</i> of Benefiar (Orchard of Murcia)
22 <i>tahúllas</i> of <i>moreal</i> lands, close to those houses	<i>Rincón</i> of Alcorr� (Orchard of Murcia)

which then ended up with Joaquín Fontes Riquelme (fourth marquis of Torre Pacheco).

The lands of Antonio Fontes Paz, third marquis of Torre Pacheco, mostly in the Orchard of Murcia, were not only large, but they also provided substantial income revenue for the family. The possession of such a vast group of properties, however, could also lead to abandoned and unproductive lands, which then became expensive for the family to repair. Repairing lands and their estate also required royal permission, as happened in 1757 with the houses of some ruined *mayorazgos* in the parish of Santa María de Murcia. Though the *mayorazgo's* revenue amounted to 6,000 *ducados*, the restoration of the houses required 9,000 *ducados*. Antonio Fontes Paz had 77,113 *reales de vellón* saved in the Depositaria General of Madrid since 1737 from the *mayorazgo* that the house of the duke of Medinaceli had founded.<sup>89</sup> Repairing *mayorazgos* and *vínculos* that had been created and accumulated over the years was an arduous task, and it represented a real economic burden for the oligarchy.

Possession and maintenance of the lands also created intrafamilial litigation – second siblings were often offended at seeing their interests undermined in favour of the first-born son. *Mayorazgo* founders, ideally, mediated and adjudicated measures to avoid such disputes, so that many family members could enjoy their inheritance.<sup>90</sup> It was common for the founder's spouse to create other *mayorazgos* of less value for the rest of the siblings, mostly, the daughters, thus avoiding familial or kinship frictions. Doña Catalina de Avilés y Fajardo founded a *vínculo* and a *mayorazgo* (see table 4.17) for her daughter Doña Laura Fontes in 1641, arguing that 'Don Baltasar Fontes, my youngest son, has and possesses many properties in *mayorazgo* to sustain his houses, and my daughter Doña Laura Fontes does not have a thing'.<sup>91</sup> Francisca Riquelme y Buendía, the spouse of Antonio Fontes Paz (third marquis of Torre Pacheco), also looked after her daughter's future and economic standing by founding a *vínculo* in 1783. Doña Segunda Fontes Riquelme, Francisca's and Antonio's daughter, received a house in Trapería Street of the parish of Santa María valued at 42,000 *reales de vellón* and a *heredad* of Velablanca in the *partido* of Pacheco (Campo de Cartagena), valued at 41,346 *reales* and 16 *maravedíes*.<sup>92</sup>

Intentions to improve the circumstances of *segundones* did not always result in easy relationships among siblings. Adding to

**Table 4.17** Properties in the *mayorazgo* of Doña Catalina de Avilés y Fajardo<sup>93</sup>

Property	Location	Value
9.5 <i>tahúllas</i> and 22 <i>brazas</i> of white lands	<i>Pago</i> of La Muela (Orchard of Murcia)	2,110 <i>reales</i> and 16 <i>maravedíes</i>
95 <i>tahúllas</i> and 24 <i>brazas</i> of white lands	<i>Pago</i> of La Muela (Orchard of Murcia)	31,669 <i>reales</i> and 29 <i>maravedíes</i>
1 contract of <i>censo</i> over the <i>hacienda</i> of Don Salvador Pedriñan	Murcia	1,000 <i>ducados</i> yearly
<i>Censo</i> over the <i>hacienda</i> of Doña Clara Bernal	Murcia	26,180 <i>reales</i>

Segunda's *vínculo* and to repair the main house, her husband Don Juan José Fernández de la Reguera invested 9,867 *reales* and 29 *maravedíes* and her father Don Antonio Fontes Paz contributed 14,965 *reales* and 29 *maravedíes*.<sup>94</sup> Such capitalisations, as the next section will demonstrate, were not enough to avoid disputes over the possession of *mayorazgos* and litigation and suits within the lineage.

#### 4.1.2. Entailed Estate: Strength or Weakness of the Main Heir? The Lawsuit vs. Riquelme Salafranca

Transfer of possessions and inheritance within the oligarchy often followed a vertical rather than a horizontal line – the first-born clearly accumulated the greatest and more important *mayorazgos* and their additions. Did this tendency make the house (family name) stagnate or enervate over time? There is a significant chance that it did, but it was the role of the *segundones*, the second siblings, their interests and the collateral relations they formed that generated the crudest disputes around the first-born.

Within the idea of primogeniture, questioning the authority of the *pariente mayor*, the *potestad* of the lineage's head, meant a breach at the centre of the group. As M. C. Gerbet puts it, friction started when *segundones* began questioning the authority of the first-born.<sup>95</sup> Given the multiplication of family lines, lineages were often at the point of rupture. The *mayorazgo* warranted consolidated and

conglomerated patrimonies, and also had an accumulative effect that resulted in pejorative and biased decisions on the rights of the *segundones* over family possessions.<sup>96</sup>

There were two main *mayorazgos* of the Riquelme lineage that came from the conglomerates founded by Don Cristóbal Riquelme de Arroniz (third lord of Santo Ángel) and his spouse Doña Nofra Riquelme de Arroniz in 1544, along with the addition of Don Luis Riquelme y Avilés (fifth lord of Santo Ángel) in 1617, and the *mayorazgo* of Don Diego Riquelme de Comontes (third lord of Coy) and his wife Doña Isabel de Bustamante, founded in 1590. Both main sections of the lineage, the Campo Coy and the Santo Ángel, joined in the figure of Don Cristóbal Riquelme y Arroniz (fifth lord of Coy and sixth lord of Santo Ángel), and from this point onward the disputes within the lineage about the maintenance and possession of the *mayorazgos* unfolded.

The *mayorazgos* coalesced in Doña Juana Riquelme, Don Francisco Rocamora's spouse, and only daughter and heir of Don Cristóbal Riquelme. After her death in 1670, an era of frequent litigation began, wherein generation after generation of different Riquelme family members sought legal recognition and legitimation over the ownership of the *mayorazgos*. It was a tense and difficult time for the lineage that continued until the 1830s, full of accusations among members of the group, and one that had no easy resolution.<sup>97</sup> Only the decisions of the high courts, the *Chancillería de Granada* and the *Consejo de Castilla*, which were often the result of long judicial processes that the litigants contested over and over again, concluded the litigations well in the nineteenth century.

#### 4.1.2.1. *Overuse of the Family Name as Key Element in Lawsuits for the Land*

In these judicial processes, the principle of *no-confusión*, stated in a bill of 1543 in the Crown of Castile that prohibited the coexistence of two *mayorazgos* of more than two million *maravedíes* under one head only, prevailed. In addition, the 1543 laws as well as the regulations at the Courts of Toro of 1504 mandated that the holder of such *mayorazgos* had to have the name, surname and *armas* (coat of arms) of the house.<sup>98</sup> These elements are recalled insistently in the litigation, demonstrating not only the material side of the



generational transmission, but also the dynasty type of transfer. The name, surname and *armas* of the founder are vertically transmitted as immaterial patrimony to preserve the memory of the lineage and of the founder of the house.

The Castilian law, although clear about accumulation of *mayorazgos*, was also lenient. It was common in the nobility to want to accumulate lands under a handful of family names to preserve the memory of the *mayorazgos* they possessed.<sup>99</sup> There is evidence that shows that family names were mixed or intentionally hidden so that only one individual appeared as the legitimate owner of the *mayorazgos*. Each of the *mayorazgos* that were going to be for Don Antonio Fontes Paz (third marquis of Torre Pacheco) had different family names attached, though all named him as the only legitimate owner:<sup>100</sup> Antonio Alonso de Paz Rodríguez de Avilés Coque y Fontes, Antonio Alonso Gonzalo de Paz Rodríguez de Avilés Coque Fontes y Peraleja, Antonio Alonso Gonzalo de Paz Rodríguez de Avilés Coque Hurtado y Fontes and Antonio Alonso Gonzalo de Paz Rodríguez de Avilés Coque Marín Blázquez y Baldés.

All these names gave Don Antonio Fontes Paz (third marquis of Torre Pacheco) the right to at least nine *mayorazgos* that Don Pedro Hurtado, Macías Coque, Diego Riquelme de Avilés, Alonso de Paz, Macías Fontes Carrillo, Juan Damián de la Peraleja, Bernardino, Alejandro Onofre Fontes and Juan Marín Blázquez y Baldés founded (*italics* by the author).<sup>101</sup> Litigations over rights to ownership were imminent because the founders determined that their successor needed to bear their name, surname and the founder's *armas*. But the law was loose in that there was no specification as to the incompatibility between the *mayorazgo* to be founded and those that would end up under one individual. Disputes emerged when one individual accumulated a large amount of properties and the income, the right to property and other economic privileges for other siblings and even other members of the lineage was significantly reduced.

A few examples demonstrate how *segundones* and other interested parties could have been infuriated after *mayorazgos* and their privileges did not come their way any more. The decision about the possession of a *mayorazgo* provided at the *Real Chancillería de Granada* on 16 October 1731 was favourable to Don Ventura Fontes Paz against Don José Fontes Riquelme. Don

Ventura became legitimate successor of even more *mayorazgos* after winning another case against Don Fernando de Melgarejo, knight of San Juan, for the *mayorazgo* that Doña Ana de Moya founded in favour of Doña Ana Melgarejo, the spouse of Macías Fontes, first marquis of Torre Pacheco.<sup>102</sup> Within the Riquelme lineage, the most important dispute began after the death of Doña Juana Riquelme. The Riquelme Arroniz Muñoz de Robles were part of the main branch of the lineage and, collaterally, they were connected to the Salafranca name. Both parts competed for the *mayorazgo* that Don Cristóbal Riquelme de Arroniz (third lord of Santo Ángel) and his spouse Doña Nofra Riquelme founded, and also for the addition that Don Luis Riquelme made to the *mayorazgo* founded by Don Diego Riquelme de Comontes (third lord of Coy) and his spouse Doña Isabel de Bustamante. Following the primogeniture principle, Don Cristóbal Riquelme Muñoz de Robles, son of Don Juan Pedro Muñoz de Robles and Doña María Riquelme, sister of Doña Juana's father, Don Cristóbal Riquelme y Arroniz (fifth lord of Coy and sixth lord of Santo Ángel) received both *mayorazgos* after Doña Juana Riquelme died.<sup>103</sup>

Contenders did not always follow what the foundation documents declared, and tensions between parties and families rapidly arose. The addition that Don Luis Riquelme y Avilés (fifth lord of Santo Ángel) made to the *mayorazgo* that Don Cristóbal Riquelme y Arroniz and his spouse Doña Nofra Riquelme founded mentioned that only a person with the Riquelme surname could inherit that *vínculo* to secure perpetual succession. The clauses of Don Diego Riquelme's and Doña Beatriz de Bustamante's *mayorazgo* established the same rule, and in another set of clauses it was established that whoever owned the *vínculo* of Don Diego would not have the Bustamante name. In this case Don Cristóbal Riquelme Muñoz de Robles had to choose one of the *mayorazgos*, but he eluded the prerogative and accumulated five *mayorazgos* that were named *Peñaranda*. These included the ones of Don Pedro Muñoz de Robles, Doña Catalina de Musso and Don Juan de Robles (from his father Don Juan Pedro Muñoz de Robles), the one that the *licenciado* Don Juan de Bustamante and Doña Ginesa de Zamora, parents of Doña Isabel de Bustamante, founded, and the one inherited by Don Gómez de Peñaranda from Doña María Riquelme y Arroniz

on his maternal side.<sup>104</sup> This time it was Antonia Riquelme Muñoz de Robles, the daughter of Juan Pedro Muñoz de Robles and Doña María Riquelme y Arroniz, who took his brother Don Cristóbal Riquelme Muñoz de Robles to court, arguing the incompatibility of the last names and the *armas* of the *vínculos*.

The decisions of the *Real Consejo* in 1693 and 1696 favoured Doña Antonia – she was the one that needed to choose between the *mayorazgos* of the Riquelme, Peñaranda and Bustamante – and her brother Don Cristóbal could retain the Muñoz and Robles ones.<sup>105</sup> However, far from concluding litigations between parties, members of the Riquelme, the Salafranca and the Muñoz de Robles names continued – and also within each of the names – the disputes went on well into the nineteenth century.<sup>106</sup>

Disputes in the collateral parts of the lineage were also constant, and a result of the manoeuvring between different families of the oligarchy. Within the Salafranca section, the Bustamante and the Peñaranda also competed for the Riquelme *mayorazgo* (see table 4.19, figure 4.25 and 4.26). Antonia Riquelme Muñoz de Robles's second marriage, to Don Antonio de Montoya, made her husband's last name come into the picture. Later, Don Bernardo Riquelme Salafranca went to court and won at the *Real Consejo de Castilla* in 1709 against Doña María de Montoya and Don Diego Riquelme de Montoya, Doña María's son.<sup>107</sup> The Rocamora family, linked to the Riquelme from the marriage between Doña Juana Riquelme and Don Francisco Rocamora, also came into play. José Antonio Rocamora and, after his death, his son Don José Nicolás Rocamora, disputed *mayorazgos* with Don Bernardo Salafranca y Riquelme and lost rights to them in different decisions in 1735 and 1739.<sup>108</sup> The more extended the lineage, the more litigations were seen in court.

The intricate relations even made some petitions go against the litigant's interests. Such was the case with Don Bernardo Riquelme Salafranca y Rocha (first marquis of Pinares)'s claim when he argued that the Muñoz and Robles *mayorazgos* were incompatible. He himself owned the *mayorazgo* that Don Gaspar de Salafranca and his spouse Doña Ana de Zúñiga founded in 1626 (see figure 4.22 and table 4.18), which had a clause that only those with the Salafranca name could inherit the *vínculo*.<sup>109</sup> In court in 1765 Doña María del Carmen Salafranca y Riquelme (with Don Lino and Don Justo Salafranca) saw her rights confirmed over his brother's, Don

Bernardo Riquelme Salafranca y Rocha, though only in terms of income. Don Bernardo had to provide a 200 *ducados* alimony each year to his sister, but he kept the ownership of the *mayorazgos* to be able to pay the required 330 *ducados* to live at the court as a *titulado* of Castile.<sup>110</sup> Nevertheless, the litigation did not stop there. In 1728 a *Real Cédula* banned the hearing of Don Francisco Riquelme Muñoz de Robles's claims against Don Lino Salafranca and Don Bernardo Salafranca y Riquelme, resulting in a favourable ruling for Don Lino in a *Real Ejecutoria* of 1737.<sup>111</sup> Don Jesualdo Riquelme y Fontes, lord of Guadalupe, continued pursuing rights over Don Bernardo Salafranca Riquelme y Rocha (first marquis of Pinares), and when the latter died in 1779, and Don Jesualdo in 1799, their heirs, Don José Riquelme Salafranca Fontes y Rocha (second marquis of Pinares) and Don Antonio Riquelme Fontes, lord of Guadalupe, followed suit. In 1827 the marquis of Pinares saw his claims affirmed and the *mayorazgos* and additions that Don Cristóbal, Nofra, Luis and Diego Riquelme, and Beatriz de Bustamante had founded, as well as the ones from Don Francisco Riquelme Muñoz y Robles, were registered under his name (see figure 4.23 and 4.24).<sup>112</sup>

The abolition of the *mayorazgos* and the mandatory dismemberment of lands in the mid-nineteenth century, however, show that the Riquelme never lost control of the *mayorazgos* from the Muñoz Robles line. Although the Salafranca name had been victorious in court, after the *Ley de Desvinculación de Mayorazgos* of Pascual Madoz in 1841 in Spain, the first of many legal attempts against the concentration of land in the nobility and the clergy in Spain, Don Antonio Riquelme y Fontes was the last owner of the *mayorazgos*.<sup>113</sup> By the mid-nineteenth century, Spanish *ancien régime* institutions were not only incapable and possibly overwhelmed with this type of litigation, but they were also already losing judicial dominance, permitting that though the Salafranca were legally legitimate owners of the land, the Riquelme, Muñoz and Robles benefited from its income.

#### 4.1.2.2. Family Strategies in the First Third of the Nineteenth Century

By the beginning of the nineteenth century, the continuous intrafamilial litigation had taken both a political and socioeconomic toll on the Riquelme lineage. The group accumulated such a vast amount of property in Murcia and beyond that maintenance of it all

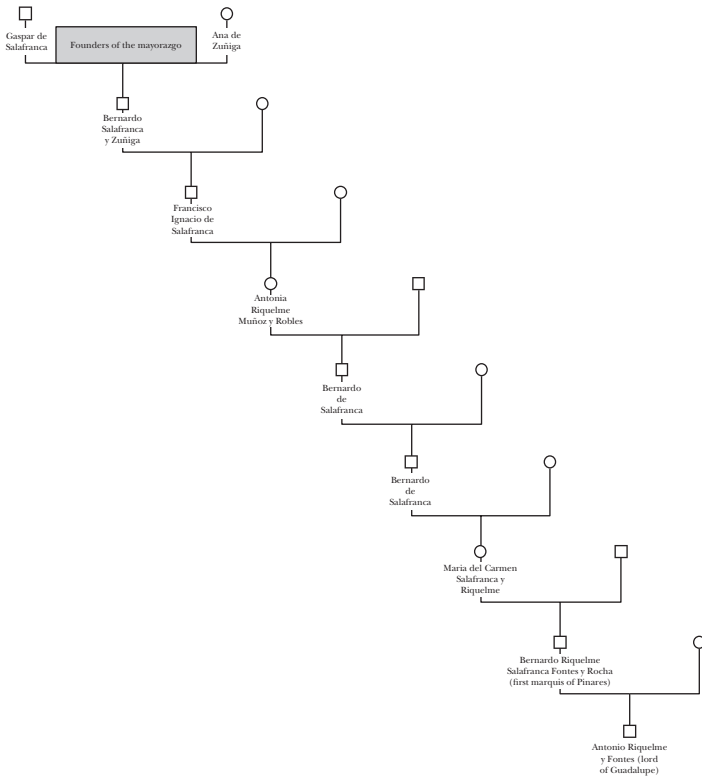

**Figure 4.22** Line of transfer of the *mayorazgo* that Don Gaspar de Salafrañca and Doña Ana de Zúñiga founded<sup>114</sup>

**Table 4.18** Properties in the *mayorazgo* of Don Gaspar de Salafrañca and his spouse Doña Ana de Zúñiga<sup>115</sup>

Property	Location	Value
Main houses	Murcia	
48 <i>tahúllas</i> of white land with <i>moreras</i>	<i>Pago</i> of La Condomina (Murcia)	
14 <i>tahúllas</i>	<i>Pago</i> of La Argualeja (Murcia)	
Main houses	Main avenue in Cartagena	
1 census contract	Over the neighbours of the Hacienda of Cartagena	4,000 <i>ducados</i>

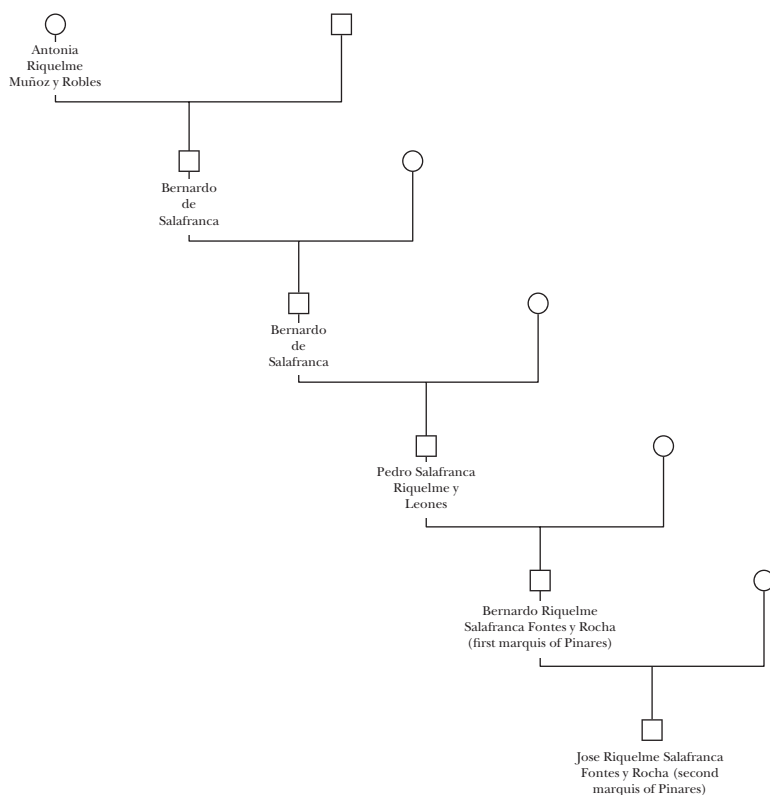

**Figure 4.23** Line of transfer of the *mayorazgo* that Don Criótoval, Doña Nofra, Don Luis, Don Diego Riquelme and Doña Isabel de Bustamante founded, as shown in the decisions of the *Consejo de Castilla*.<sup>116</sup>

was expensive. The economic profit from the land was draining as a result, and litigations continued to mount because of the incompatibility of combining *mayorazgos*. In addition, biological depletion was imminent – an intrinsic consequence of *mayorazgo* practices – after decades of following a vertical line of succession and prioritising accumulation in the hands of the first-born. The genealogical trees of the Riquelme lineage show a clear reduction in the number of children by the beginning of the nineteenth century. The lack of heirs was now the problem rather than the *segundones*.

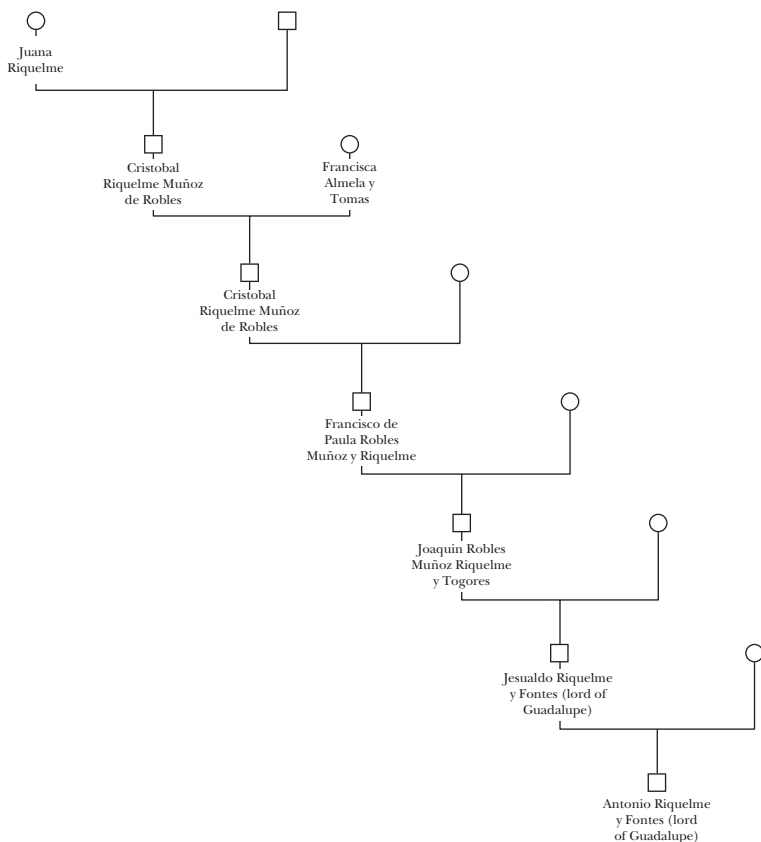

**Figure 4.24** Line of transfer of the *mayorazgo* that Don Cristóbal, Doña Nofra, Don Luis, Don Diego Riquelme and Doña Isabel de Bustamante owned in real and practical terms<sup>117</sup>

In the long term, it was one of the factors that explained why *mayorazgos* remained in the principal line of the Riquelme, and even the section of the Muñoz Robles's ended up under Jesualdo Riquelme y Fontes and his son Antonio Riquelme y Fontes, the last owner of the *mayorazgos* when the *Ley de Desvinculación* was enacted in 1841.

The *mayorazgo* was, in a way, collective suicide, as J. P. Dedieu puts it. It contributed to biological depletion at the end of the eighteenth century.<sup>119</sup> To avoid it, however, the Riquelme followed a new

**Table 4.19** Riquelme lineage branches competing for the Riquelme, Muñoz, Robles, Bustamante, Peñaranda and Salafranca *mayoralzgos*<sup>118</sup>

<i>Muñoz-Robles</i>	<i>Salafranca, Montoya y Rocamora</i>
Cristóbal Riquelme Muñoz Robles ↔	Antonia Riquelme Muñoz de Robles
Francisco Riquelme Muñoz Robles ↔	Lino Salafranca
	Bernardo Riquelme Salafranca
	Bernardo Riquelme Salafranca
	Luis Curiel y Tejada ( <i>Fiscal</i> )
	↕
	María Montoya y Riquelme
	Diego Riquelme y Montoya
	Bernardo Riquelme y Salafranca
	↕
	José Antonio Rocamora
	María del Carmen Salafranca Riquelme y Rocha
	↕
	Bernardo Riquelme Salafranca y Rocha
	Lino Salafranca y Riquelme
	Justo Salafranca y Riquelme
Jesualdo Riquelme Fontes ↔	Bernardo Salafranca y Riquelme (first marquis of Pinares)
	María del Carmen Salafranca y Riquelme
	Francisco Faustino Salafranca y Riquelme
	Justo Salafranca y Riquelme
Antonio Riquelme y Fontes ↔	José Salafranca Riquelme y Fontes (second marquis of Pinares)



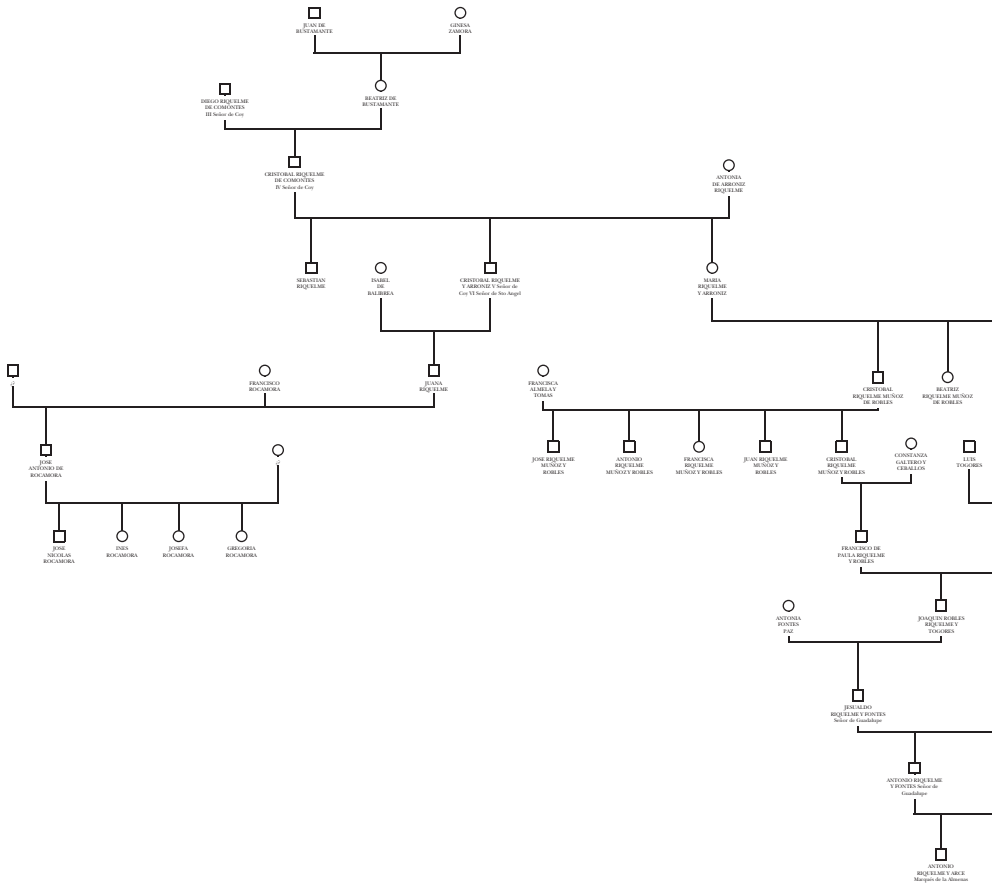
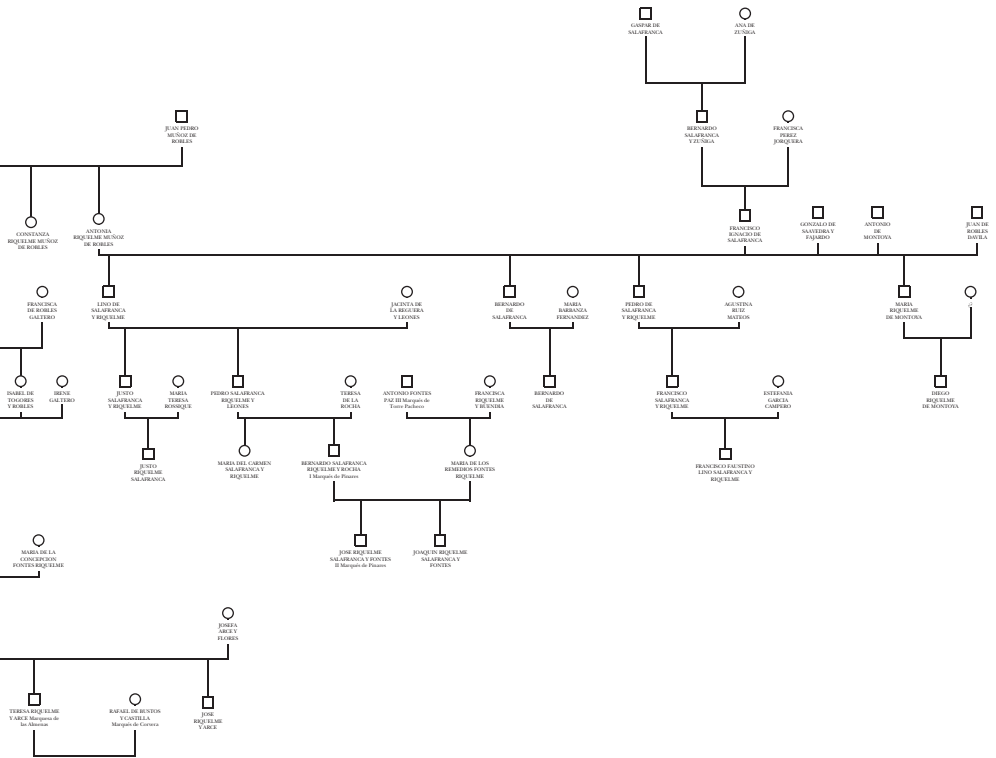
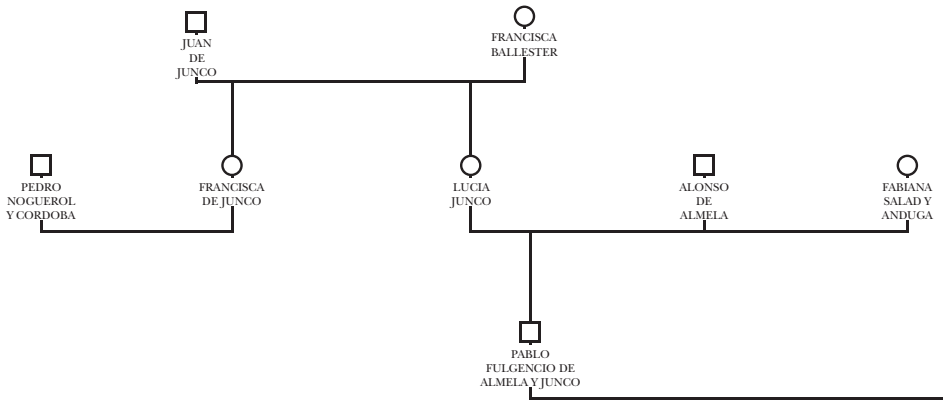
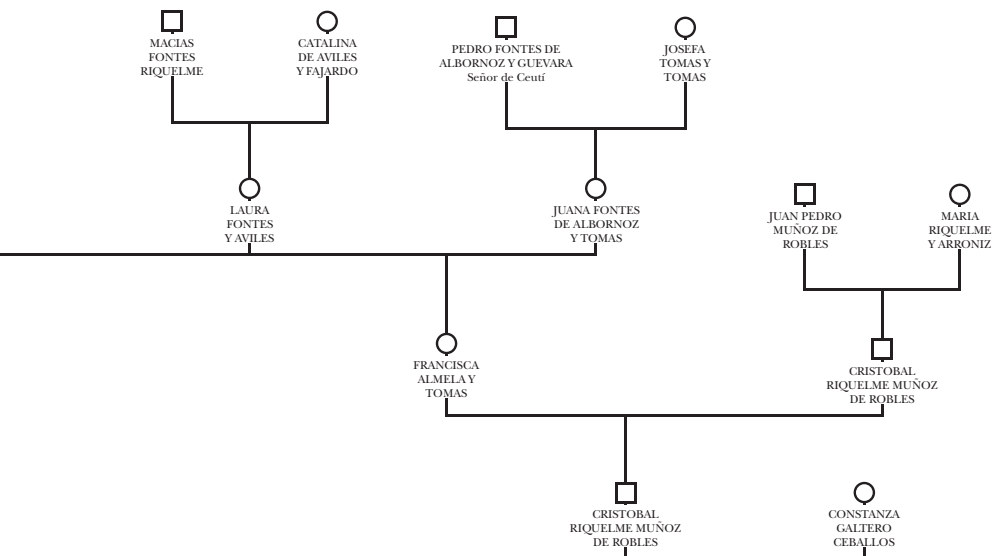

Figure 4.25 Genealogy of Riquelme family in coalition with Salafrañca family, sixteenth to nineteenth centuries





**Figure 4.26** Genealogy of Riquelme family in coalition with Almela, Junco, Salad y Anduga y Tomas Families, sixteenth to seventeenth centuries



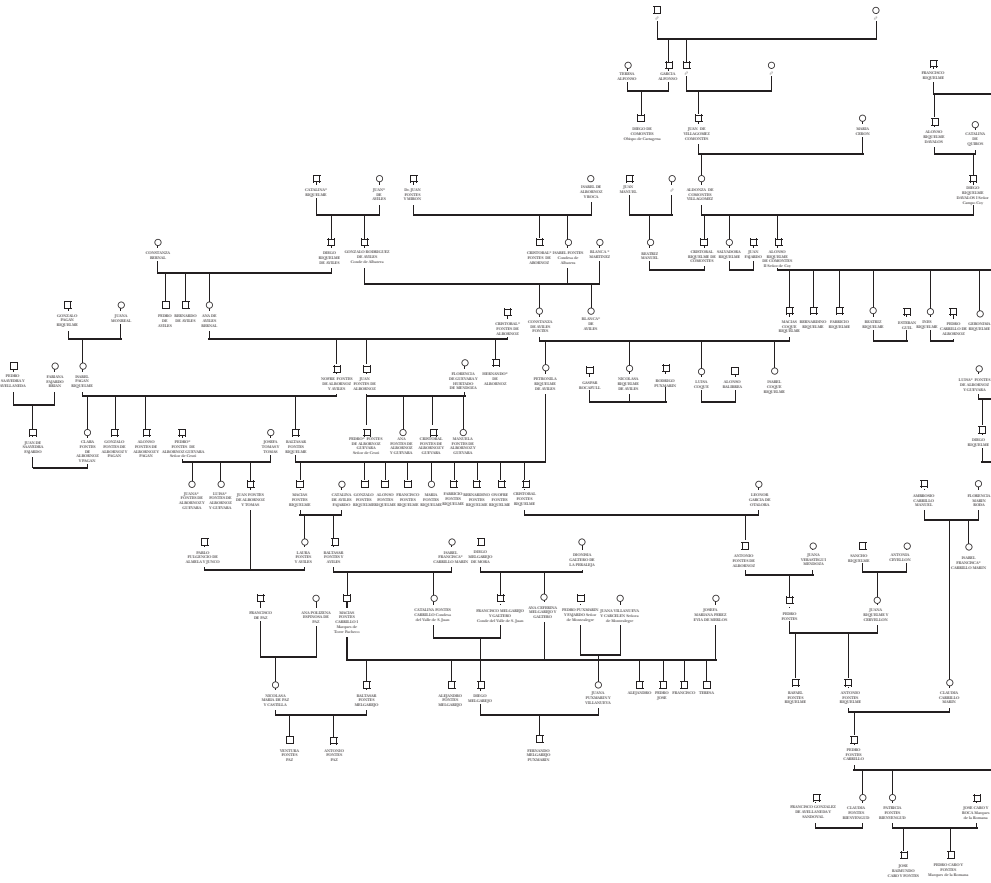

Figure 4.27 Genealogy of Riquelme lineage, thirteenth to nineteenth centuries



strategy of social enclosing by marrying thriving oligarch families at the beginning of the nineteenth century. The Musso, Sandoval and Zarandona families were an example of the new connections, as well as the marquisate of Corvera of Don Rafael de Bustos y Castilla, who married Doña Teresa Riquelme y Arce, the daughter of Antonio Riquelme y Fontes.<sup>120</sup>

Regardless of the decline, the Riquelme lineage still had a significant socioeconomic status in the Murcian oligarchy (see figure 4.27 and appendix pp. 322–5). The accumulation under Don Antonio Riquelme y Fontes was extraordinary, and also there was no demonstrated separation or abandonment of lands after the *Ley de Desvinculación* of *mayorazgos* in Spain. The Riquelme lineage continued to enjoy their properties divided among each family member, with the added value that properties could now be put on the market. After the mid-nineteenth-century legislation, lands could be sold and purchased, or any other means of financial transaction conducted, which contributed to mortgage credit and other incomes and economic benefits. The Riquelme profits did not necessarily decrease, and the properties continued to be transferred within the family – Don Antonio Riquelme y Fontes’s will of 1843 distributed the lands among all his children and thus the land remained intact, within the family.<sup>121</sup> The extensive, complex social network of the Riquelme lineage (see table 4.20), based in solidarity and clientelist relations with other families in the Murcian elite, took longer to break up than just passing a couple of laws; it took almost as long to dismantle as it had taken to emerge.<sup>122</sup>

**Table 4.20** Social network of the Riquelme created by founding *mayorazgos*

Collateral family names	Riquelme, main line	Collateral family names
Rocamora		Fontes Carrillo
Junco	<b>Arroniz</b>	Coque
Fontes		Paz
Hurtado de Mendoza	<b>Riquelme</b>	Avilés
Bernal		Salad y Anduga
Muñoz	<b>Comontes</b>	Bustamante
Pagan		Fontes Albornoz
Moya		De la Peraleja

# Conclusions

---

This book has examined the social, political, economic and cultural structures of an *ancien régime* society in Mediterranean Europe, in the Crown of Castile, through the study of the family. Social stability depends upon the family, both in its diverse forms and in its historical evolution. In early modern Spain, the family was a dynamic institution with marked patterns of behaviour primarily characterised by the head of the family guiding, preserving and guarding family values and protecting new members who became part of the main family group. The family was thus a diverse, social and lively institution, always changing and evolving, adapting and transforming. The scholarly perspective that states the distance between the individual and society can only be studied through the family, and this study takes this viewpoint in full form.<sup>1</sup>

In addition to placing the family as the focal point when analysing a European *ancien régime* society, a *longue durée* perspective has also been fundamental throughout the book. By ignoring traditional chronological time frames that limit how deeply historians can explore processes in the medieval and early modern periods, this study provides a long-duration view of the social patterns, actions, dynamics and strategies of a lineage over five centuries. The Riquelme lineage from the kingdom of Murcia is this book's main case study, from their initial settlement in the frontier region of Murcia in 1266 to the first half of the nineteenth century.

In particular, following the different trajectories that the Riquelme lineage travelled towards its consolidation as a prestigious noble family in the myriad institutions and public offices of the *concejo* between the sixteenth and the eighteenth century offers an ample vision of the social position of the lineage. It is possible to



define and explain, much more precisely, the mechanisms and strategies that the lineage chose in order to perpetuate its power and reproduce itself socially. The Riquelme became an integral part of the Murcian oligarchy: they kept evolving and adapting through social and political strategies to new circumstances and social contexts with the aim of permanently staying in different power institutions for long periods of time.

The Riquelme and the family groups close to them settled in Murcia in 1266. They formed part of the military contingents coming from the north of Castile looking for better lands and wealth. After victory against the Muslims in the fifteenth century, the lineage began building its glory in Murcia. To perpetuate their memory and the collective imaginary, the group emblazoned houses with heraldic coats of arms, performed memorial acts and created genealogies. All of this was carried out with the objective of making the public remember, through material and written culture, the glories and achievements of their common predecessor, the founder of the house, a mythical figure that everyone venerated. Once the conquest of the kingdom of Murcia in southern Castile was completed, the lineage settled as knights who took over the land to exploit the irrigated fields and the Murcian orchards. Massive occupation of the land only happened when there was a complete conquest of the Nasrid kingdom of Granada. Before this, Murcia had been a frontier territory often under attack and with its cultivated lands destroyed.

When Alfonso XI's call for reconquest was reactivated, it was the right time for the Riquelme to start consolidating and building their power through war. They were able to adapt to incredibly unstable circumstances and continue establishing themselves through notable achievements in armed conflict and conquest, all in the name of Christendom. The appearance of the Riquelme members in Alfonso XI's military contingent and in the 1374 census of *caballeros cuantiosos* that John I ordered to be carried out was not in vain. Those that remained as defenders of Christianity and close to the Castilian cause during the reconquest won favours from the monarch after the war and reached positions of power by taking over key high-ranking and prestigious official positions.

The Riquelme also tried to stay under the tutelage and protection of the Fajardo family, already by the fifteenth century the most powerful in the kingdom. Both the Riquelme and the

Fajardo held leading positions and public offices, leaving behind old noble families such as the Manuel and causing rising envy from other settled families who had a long tradition in the *concejo*, which was open up until that moment. Now, as the new noble families forced public offices such as the *regidurías* to be filled with lifetime positions, the *concejo* became a closed entity. Lineage disputes and civil war in the kingdom of Murcia in the fourteenth century were a result of these rising tensions and conflicts. The Riquelme's smart political strategy to consolidate their power was twofold: to remain by the Fajardo's side and not to involve the monarch too much in the lineage disputes. All this helped to overthrow the Manuel family and other groups of the old nobility, and, in the process, the role of clientelism, patronage, solidarity and fidelity in social mobility became key. Furthermore, new patterns of social, political and economic interests of emerging families began to arise.

Lineage disputes continued through the early modern period, and they provide essential information for scholars analysing how families regrouped according to social, political and economic interests. The fights between sections were diachronic, dissipating at times and re-emerging later, as evidenced in the conflict between Soto and Riquelme through the long-lasting *comunero* revolts. The disputes went on even through the eighteenth century, when the union between families from Murcia and Extremadura like Fontes and Paz had the sole goal of exterminating the enemy by the common oral-based baroque society methods of slander and insult.

The Riquelme, once in power, continued to push for more and to consolidate the family among the most powerful groups of Murcia. The juncture that emerged in the last third of the fifteenth century was just what they needed in order to do so. The Riquelme had supported the Catholic monarchs' cause and had also participated in the final conquest of the kingdom of Granada. The family found ways to hold power and achieve great splendour in two locations by holding high office both in the royal court and in Murcia.

Emblems, coats of arms, crests, palaces, portraits, memorials, chapels, burials and altars were all part of the same enterprise to memorialise how the lineage contributed to conquest and also to show their membership of the ethnic group of *cristianos viejos*. During the early modern period, being part of the Christian conquest, and the consequent demise of Granada's Muslims, was

central for the lineage's boastful displays of their past role. It became a guarantee as well when the purity of blood examinations started to be a requirement to access official positions in the *concejo*, and especially as part of the *regidurías*, the *cabildo eclesiástico*, the *canonjías* and all kinds of *prebendas* such as *hábitos*, military orders, *familiaturas* of the *Santo Oficio*, *mayordomías* in the main *cofradías*, or even as *colegial* of an illustrious *Colegio Mayor*.

After conquering Murcia and establishing their social and political power basis in the region, the Riquelme's goal became their economic power consolidation and increase of wealth. The *señorío* of Santo Ángel had been founded already by the fifteenth century and this group of lands included part of the Murcian Orchard. After the reconquest, they occupied lands in Lorca, which became the *señorío* of Campo Coy, Caravaca, Cehegín and Bullas in the first half of the sixteenth century, and in the former kingdom of Granada, Baza, Huércal-Overa and Huéscar. Coy and Santo Ángel, the main lines of the Riquelme lineage, were the starting point of an extensive family patrimony that became linked through *mayorazgos*.

This study has greatly relied on the *mayorazgo* to track and analyse the consolidation and transformation of the Riquelme as an example of a noble landowning family in a community of Mediterranean Europe. As noted, their first possessions were the *mayorazgos* of Coy and Santo Ángel, followed by three centuries' accumulation of *mayorazgos* until 1841, when the Spanish liberal reform *Ley de Desvinculación del Mayorazgo* was passed. The sources on the *mayorazgo* and its evolution in the Riquelme case are key to my examination because they provide a starting point (the foundation in the fifteenth century) and the entire process of aggregation, accumulation and circulation that involved all lines of the lineage up to the nineteenth century. The *mayorazgo* allows for a retrospective analysis of the changes and continuities in the transition from the *ancien régime* to nineteenth-century political and social liberal societies.

In pre-industrial societies, the *mayorazgo* was the oligarchy's centre of socioeconomic power. Control over the land, including the water sources and the productive plantations, was the landowners' power currency in a rural and agriculturally based society. And this was especially true in a territory like Murcia, historically dry and no stranger to long periods of drought.

Control of the land became tightly related with control of public offices as well, particularly *regidurías* that were lifetime positions transmitted through *mayorazgos*. Within the oligarchy, socio-economic and political power went hand in hand. This relationship also explains the importance of marriage alliances and strategies as the main mechanism for the lineage's social reproduction and its increase in power in the social, political and economic arenas simultaneously.

The construction of a social network of family bonds was based on a rigorous marriage strategy that allows for a close examination of the social process of accessing and increasing power and wealth in the early modern era. Well-known family names were part of complex processes of upward mobility that are only accessible by following the families' meticulous mechanisms to be connected. The relations that these marriages created were long-term, tight relationships also based on ties of clientelism, fidelity, solidarity and patronage.

The fabric that oligarchic families wove was strong, and by the sixteenth century it began to include not only nobility groups exclusively. The union between the Riquelme family, which was part of the nobility, with family names such as Robles or Muñoz from the Caravaca region, who were part of an emerging social group of traders and artisans, or professionals such as lawyers, secretaries, scribes or from the *procuradurías*, illustrates this point. The social escalation of these families came from their union with other families as well such as the Dávila or Musso families. Not only emerging families found their way up – there were clear benefits for those in the oligarchy and for their lineages to open up at times. In other circumstances they closed ranks through the *bucle matrimonial* (marriage turn). The oligarchy changed and adapted over time, though by the end of the early modern period it still was an impermeable social group.

Analysis of the alliances and processes of transformation and change is what allows an understanding of the extension of the Riquelme social network towards the middle layers of society in the eighteenth century. The links to these groups are not only based on consanguinity, specifically those with *allegados* who held positions as scribes or lawyers, or in the *procuradurías* or *secretarías* of the city's *Tribunales Ordinarios de Justicia*, the *Chancillería de Granada* or the *Consejo de Castilla*.

The increase in ownership disputes is what made having good relationships with non-consanguineal individuals important. *Mayorazgo*-related cases continued to pile up in the *Real Chancillería de Granada* and in the *Consejo de Castilla*. Having an inside connection with someone who would support a case was important in receiving a favourable decision. Decisions generally declared one of the litigants the legitimate owner. However, when a *desvinculación* occurred, it was the opposite side, the party condemned to restore the properties that enjoyed and could make the *mayorazgo* productive. In the end, although it was not formally declared a principle, the definitive owner of the *mayorazgo* was the main line of the lineage, the Riquelme Muñoz de Robles. It was a sign of the weakening and stagnation of the basis of the administrative and judicial powers of the *ancien régime*. The influence and accumulation of positions in the *Consejo de Castilla* and the *Chancillería* was overwhelming to the point that the institutions could not handle the number of cases presented. It was a clear sign of an ongoing decline of the administration's capabilities.

The same *mayorazgo* that fed even more marriage unions among the lineage and the oligarchy was the cause and source of its waning. The persistence of the first-born privileges generated disputes among family members, and especially among the *segundones*. Endogamy was also practised regularly to avoid wealth dispersal, though this also ended up reducing the number of children, and especially male heirs, thus contributing to the progressive biological stagnation.

In turn, in the first third of the nineteenth century, the Riquelme family reopened to families that were economically and socially emerging such as the Fernández de la Reguera family, one deeply rooted in oligarchic names like Zarandona, Prieto, Sandoval, Musso or Avellaneda. The connections with these families were based both on family and non-family ties – friendship, solidarity, loyalty, living in the same region, and other forms of kinship such as spiritual affinities and joint godfatherhood or *compadrazgo*. These were some of the mechanisms through which the Riquelme family continued to hold great influence among the elite in the nineteenth century. One space where this is visible is the *cofradías*. Most of the members of the *Cofradía de Santiago de la Espada*, for example, located in the city hall, were (noble) *regidores*. When they celebrated *cabildos*, they did it as if they were of the *concejos*. The

*Cofradía* de Santiago de la Espada had its meetings at the city hall where the *regidores* (almost all also members of the *cofradía*) had also met. Though the *Cofradía* de Santiago de la Espada had lost its prominence by the 1810s, the *pasionaria Cofradía* de Nuestro Padre Jesús Nazareno maintained and took over its status. As in other spaces of power, the shift of positions of some members of prominent families implied that one *cofradía* would advance in nobility status over time over others. Still, the same pattern of behaviour and exercise of power remained in place.

The connections of the Riquelme family were so diverse and extensive that when the 1841 law to dismantle *mayorazgos* was passed, most of their properties remained theirs to sell or mortgage. The lineage's socioeconomic and political power hovered over the state's moves towards liberalism, and their influence remained entrenched in the Murcian oligarchy. Spanish liberalism's impact on the oligarchy's behaviour, practice and social mechanisms was not great. This study of centuries of social network building demonstrates that family, clientele, patronage and solidarity relationships among the oligarchy were deeply rooted in society, and that only drastic changes such as civil wars would result in the rupture of clientelism and dependence-based ties. In the nineteenth century, the Riquelme family still held key positions of power through titles such as the marquises of Las Almenas and Corvera, the viscounty of Rías, and the marquises of Salinas, Ordoño and Beniel.

Legislation for political change followed a different and often parallel path to the social, economic and political interests on which the permanence of the institutions was sustained. Medieval and *ancien régime* structures in Spain were long-lasting, and some prevailed over any drastic change of the social system, even in the nineteenth century. The oligarchy's and elite's social actors' resistance to nineteenth- and even twentieth-century efforts to implement social and economic change was evident, and thus their influence and power, and also certain social practices from the medieval period and the *ancien régime*, persisted. Change occurred slowly as social relationships and connections endured over time.

# Bibliography

---

- Abadía, A., *La enajenación de rentas señoriales en el Reino de Aragón* (Zaragoza: Institución Fernando el Católico, 1998).
- Accati Levi, L., 'Il matrimonio fra lo stato e la chiesa, la sposa fra marito e figlio', in M. V. López Cordón and M. Carbonell Esteller (eds), *Historia de la mujer e historia del matrimonio* (Murcia: Universidad de Murcia, 1997), pp. 35–44.
- Adelman, J., *Republic of Capital: Buenos Aires and the Legal Transformation of the Atlantic World* (Stanford, CA: Stanford University Press 1999).
- Álvarez-Ossorio Alvariño, A., 'El arte de medrar en la corte: rey, nobleza y el código del honor', in J. Chacón Jiménez and J. Hernández Franco (eds), *Familia, poderosos y oligarcas* (Murcia: Universidad de Murcia, 2001), pp. 39–60.
- Álvarez-Ossorio Alvariño, A., 'El Favor Real: liberalidad del príncipe y jerarquía de la república (1665–1700)', in C. Continisio and C. Mozzarelli (eds), *Repubblica e Virtù. Pensiero politico e Monarchia Cattolica fra XVI e XVII secolo* (Rome: Bulzoni, 1995), pp. 393–405.
- Amorim, M. N., 'Demografia Histórica e Família. Uma proposta metodológica', *Studia Historica*, 18 (1998), 29–54.
- Anderson, P., *Lineages of the Absolutist State* (London: NLB, 1974).
- Andújar Castillo, F., *Consejo y consejeros de guerra en el siglo XVIII* (Granada: Universidad de Granada, 1997).
- Andújar Castillo, F., *El sonido del dinero. Monarquía, ejército y venalidad en la España del siglo XVIII* (Madrid: Marcial Pons, 2004).
- Andújar Castillo, F., *Los militares en la España del siglo XVIII. Un estudio social* (Granada: Universidad de Granada, 1991).
- Aragón Mateos, S., *La nobleza extremeña en el siglo XVIII* (Mérida: Biblioteca Pública Municipal Juan Pablo Forner, 1991) Asch, R. G. and Birke, A. M., *Princes, Patronage and the Nobility. The Court at the Beginning of the Modern Age c. 1450–1650* (Oxford: Oxford University Press, 1991).
- Atienza Hernández, I., *Aristocracia, poder y riqueza en la España Moderna. La Casa de Osuna, siglos XV–XIX* (Madrid: Siglo XXI, 1987).

- Atienza Hernández, I., 'Consenso, solidaridad vertical e integración versus violencia en los señoríos castellanos del siglo XVIII y la crisis del Antiguo Régimen', in E. Sarasa and E. Serrano (eds), *Señorío y feudalismo en la Península Ibérica (Siglos XII–XIX)*, vol. 2 (Zaragoza: Institución Fernando el Católico, 1993), pp. 275–.
- Atienza Hernández, I., 'La construcción de lo real. Genealogía, casa, linaje y ciudad: una determinada relación de parentesco', in J. Casey and J. Hernández Franco (eds), *Familia, parentesco y linaje. Historia de la familia, una nueva perspectiva sobre la sociedad europea* (Murcia: Universidad de Murcia, 1997), pp. 41–59.
- Baeza, R., *Poema del Cid* (Buenos Aires: Editorial Atlántida S.A, 1952).
- Barbazza, M. C., 'Propiedad campesina y transmisión en Castilla la Nueva en los siglos XVI y XVII', in F. García González (ed.), *Tierra y familia en la España Meridional, siglos XIII–XIX* (Murcia: Universidad de Murcia, 1998), pp. 87–102.
- Bazzana, A., 'El concepto de frontera en el Mediterráneo occidental en la Edad Media', *Actas del Congreso: La frontera oriental nazarí como sujeto histórico (Siglos XIII–XVI)* (Lorca-Vera: Instituto de Estudios Almerienses, 1994), pp. 25–46.
- Beceiro Pita, I. and Córdoba de la Llave, R. (eds), *Parentesco, poder y mentalidad. La nobleza castellana siglos XII–XV* (Madrid: CSIC, 1990).
- Beceiro Pita, I., 'La mujer noble en la Baja Edad Media castellana', in Y. R. Fonquerne and A. Esteban (eds), *La condición de la mujer en la Edad Media* (Madrid: Casa de Velázquez, Universidad Complutense, 1986), pp. 289–314.
- Bell, D. A., 'Total History and Microhistory: The French and Italian Paradigms', in L. Kramer and S. Maza (eds), *A Companion to Western Historical Thought* (Oxford: Blackwell, 2006), pp. 262–76.
- Benaiteau, M., 'Una nobiltà di lunga durata: strategie e comportamenti dei Tocco di Montemiletto', in María A. Visceglia (ed.), *Signori, patrizi, cavalieri nell'età moderna*, Biblioteca di Cultura Moderna (Bari: Laterza, 1992), pp. 193–213.
- Bennassar, B., *L'Inquisition espagnole* (París: Hachette, 1979).
- Bennassar, B., 'Vivre à Andujar au XVIIIe siècle', *Actas del I Congreso de Historia de Andalucía Moderna siglos XVI–XVII*, 1 (1978), pp. 131–41.
- Bernal, A. M. and Lacroix, J., 'Aspects de la sociabilité andalouse. Les associations sévillanes, XIXe–XXe siècles', *Mélanges de la Casa de Velázquez*, 11 (1975), 435–507.
- Bertrand, M., 'Familles, fidèles et réseaux: les relations sociales dans une société d'Ancien Régime', in J. L. Castellano and J. P. Dedieu (eds), *Réseaux, familles et pouvoirs dans le monde ibérique à la fin de l'Ancien Régime* (Paris: CNRS, 1998), pp. 169–90.



- Bertrand, M., 'Historia social y análisis micro histórico', *Cuadernos digitales: publicación electrónica en Historia, Archivística y Estudios Sociales*, 6/17 (2002), 1–17.
- Bestard, J., *Casa y Familia. Parentesco y reproducción doméstica en Formentera* (Palma de Mallorca: Institut d'Estudis Baleàrics, 1986).
- Bestard, J., 'La estrechez del lugar. Reflexiones en torno a las estrategias matrimoniales cercanas', in F. Chacón Jiménez and J. Hernández Franco (eds), *Poder, familia y consanguineidad en la España del Antiguo Régimen* (Barcelona: Anthropos, 1992), pp. 107–56.
- Bestard, J., *Parentesco y modernidad* (Barcelona: Paidós, 1998).
- Bestard, J. and Perez-Garcia, M. (eds), *Familia, valores y representaciones* (Murcia: Universidad de Murcia, 2010).
- Bethencourt, F., *The Inquisition: A Global History* (Cambridge: Cambridge University Press, 2009).
- Blackburn, P., and Economou, G., *Poem of the Cid: A Modern Translation with Notes* (Norman: University of Oklahoma Press, 1998).
- Blázquez Miguel, J., 'Catálogo de los procesos inquisitoriales del Tribunal del Santo Oficio de Murcia', *Murgetana*, 74 (1987), 7–109.
- Bloch, M., 'Pour une histoire comparée des sociétés européennes', *Revue de synthèse historique*, 46 (1928), 15–50.
- Boone, J. L., 'Parental Investment and Elite Family Structure in Preindustrial States: A Case Study of Late Medieval–Early Modern Portuguese Genealogies', *American Anthropologist*, 88 (1986), 859–78.
- Bott, E., *Familia y red social. Roles, normas y relaciones externas en las familias urbanas corrientes* (Madrid: Taurus, 1990).
- Bourdieu, P., *Le sens pratique* (Paris: Les Éditions de Minuit, 1980).
- Bourquin, L., *Noblesse seconde et pouvoir en Champagne aux XVIe. et XVIIe. siècles* (Paris: Publications de la Sorbonne, 1994).
- Bouza, F., *Portugal no tempo dos Filipes: política, cultura, representações (1580–1668)* (Lisbon: Cosmos, 2000).
- Boyajian, J. C., *Portuguese Trade in Asia under the Habsburgs, 1580–1640* (Baltimore: Johns Hopkins University Press, 1993).
- Brading, D. A., 'Bourbon Spain and its American Empire', in L. Bethel (ed.), *The Cambridge History of Latin America*, vol. 2: *Colonial Latin America* (Cambridge 1984), pp. 392–439.
- Braudel, F., *El Mediterráneo y el mundo mediterráneo en la época de Felipe II*, vols I–II (Madrid: Fondo de Cultura Económica, 1976).
- Breteau, Cl. H. and Zagnoli, N., 'Le système de gestion de la violence dans deux communautés rurales méditerranéennes: la Calabre méridionale et le N.E. Constantinois', in R. Verdier (ed.), *La vengeance dans les sociétés extra-occidentales* (Paris: Cujas, 1980), pp. 43–73.
- Brooke, C., *The Medieval Idea of Marriage* (Oxford: Clarendon Press, 1989).

- Brumont, F., *Paysans de Vieille-Castille aux XVIe et XVIIe siècles* (Madrid: Casa de Velázquez, 1993).
- Brunner, O., *Terra e potere: strutture pre-statali e pre-moderne nella storia costituzionale dell'Austria medievale* (Varese: Giuffrè, 1983).
- Buttigieg, E., *Nobility, Faith and Masculinity: The Hospitaller Knights of Malta, c.1580–c.1700* (London: Bloomsbury, 2011).
- Cachón, L., *¿Movilidad social o trayectoria de clase?* (Madrid: Siglo XXI, 1989).
- Caillé, A. (ed.), 'Donner, recevoir et rendre: l'autre paradigme', *Revue du MAUSS*, 11 (1991), 3–89.
- Cannadine, D., *The Undivided Past: History Beyond Our Differences* (London: Penguin Books, 2013).
- Carasa, P., 'La recuperación de la historia política y la prosopografía', in P. Carasa (ed.), *Elites: prosopografía contemporánea* (Valladolid: Universidad de Valladolid, 1994), pp. 41–51.
- Carmona González, A., 'La frontera: doctrina islámica e instituciones nazaríes', *Actas del Congreso: La frontera oriental nazarí como sujeto histórico (Siglos XIII–XVI)* (Lorca-Vera: Instituto de Estudios Almerienses, 1994), pp. 47–57.
- Caro Baroja, J., *Los judíos en la España moderna y contemporánea*, vol. 1 (Madrid: Istmo, 2000).
- Caro Baroja, J., *Los moriscos del Reino de Granada* (Madrid: Instituto de Estudios Políticos, 1957).
- Carrasco, R. (ed.), *Solidarités et sociabilités en Espagne, XVIe–XXe siècles* (Paris: Annales Littéraires de l'Université de Besançon, 1991).
- Carvalho, H., 'Lineage, Marriage and Social Mobility: the Teles de Meneses Family in the Iberian Courts (Fifteenth and Sixteenth Centuries)', *e-Journal of Portuguese History*, 14 (2016), 2–19.
- Carvalho, J. and Campos, R., 'Interpersonal networks and the archaeology of social structures; using social positioning events to understand social strategies and individual behavior', *Revista de História da Sociedade e da Cultura*, 7 (2007), 175–93.
- Casaús, M. E., 'La pervivencia de las redes familiares en la configuración de la elite de poder centroamericana. El caso de la familia Durán', *Anuario de Estudios Centroamericanos*, 20/2 (1994), 41–69.
- Cascales, F., *Discursos históricos de la ciudad de Murcia y su Reino* (Murcia: Academia Alfonso X el Sabio, 1980).
- Casey, J., 'Familia y sociedad' in *El mundo hispánico. Homenaje a John Elliott* (Barcelona: Crítica, 1991), pp. 185–202.
- Casey, J., *Family and Community in Early Modern Spain: The Citizens of Granada, 1570–1739* (Cambridge: Cambridge University Press, 2007).
- Casey, J., *The History of the Family* (Oxford: Basil Blackwell, 1989).

- Casey, J. and Hernández Franco, J. (eds), *Familia, parentesco y linaje* (Murcia: Universidad de Murcia, 1997).
- Catalán, D. (ed.), *Gran Crónica de Alfonso XI*, vol. 1 (Madrid: Universidad Complutense de Madrid, 1976).
- Catedra, P., 'Fray Vicente Ferrer y la predicación antijudaica en la campaña castellana 1411-1412', in *Qu'un sang impur . . . Les converses et le pouvoir en l'Espagne à la fin du moyen âge, Actes du deuxième colloque d'Aix-en-Provence, 18, 19 and 20 November 1994* (Marseille: Université de Provence, 1997), pp. 19-46.
- Cerdá, J., 'Adelantados Mayores y concejo de Murcia', *Estudios jurídico-medievales de Murcia y de su reino* (1987), 121-67.
- Cerutti, S., 'La construction des catégories sociales', in J. Boutier and D. Julia (eds), *Passés recomposés: Champs et chantiers de l'histoire* (Paris: Autrement, 1995), pp. 224-349.
- Cerutti, S., 'Normes et pratiques, ou la légitimité de leur opposition', in B. Lepetit (ed.), *Les formes de l'expérience: une autre histoire sociale* (Paris: Albin Michel, 1995), pp. 127-49.
- Chacón, F. and Bertran, J. (eds), *Familias. Historia de la sociedad española (del final de la Edad Media a nuestros días)* (Barcelona: Crítica, 2011).
- Chacón Jiménez, F., 'Aproximación y notas metodológicas para el estudio de la familia en Castilla durante la Baja Edad Media. Algunos ejemplos murcianos', in *Homenaje a Juan Torres Fontes* (Murcia: Universidad de Murcia-Academia Alfonso X el Sabio, 1987), pp. 337-48.
- Chacón Jiménez, F., 'Continuidad de costumbres y transmisión de la propiedad en el sistema familiar castellano, siglos XVI-XVIII', in F. Chacón Jiménez (ed.), *Historia social de la familia en España: aproximación a los problemas de familia, tierra y sociedad en Castilla (Siglos XV-XIX)* (Alicante: Diputación Provincial de Alicante, Instituto Alicantino de Cultura Juan Gil-Albert, 1990), pp. 47-59.
- Chacón Jiménez, F., 'Hacia una nueva definición de la estructura social en la España del antiguo régimen a través de la familia y las relaciones de parentesco', *Historia Social*, 21 (1995), 75-104.
- Chacón Jiménez, F., 'Introducción a la Historia de la Familia en España. El ejemplo de Murcia y Orihuela (Siglos XVII-XIX)', in F. Chacón Jiménez (ed.), *Historia Social de la Familia en España: aproximación a los problemas de familia, tierra y sociedad en Castilla (Siglos XV-XIX)* (Alicante: Diputación Provincial de Alicante, Instituto Alicantino de Cultura Juan Gil-Albert, 1990), pp. 137-64.
- Chacón Jiménez, F., 'Las comunidades un conflicto de intereses', *Historia de la Región de Murcia*, 5 (1980), pp. 15-21.
- Chacón Jiménez, F., 'Los señores del agua. Estudio de un proceso de polarización social en Lorca. Siglos XV-XVII', *Agua, riegos y modos de*

- vida en Lorca y su comarca* (Lorca: Ayuntamiento de Lorca, 1986), pp. 17–50.
- Chacón Jiménez, F., 'Notas para el estudio de la familia en la región de Murcia durante el Antiguo Régimen', in F. Chacón Jiménez (ed.), *Historia Social de la Familia en España: aproximación a los problemas de familia, tierra y sociedad en Castilla (Siglos XV–XIX)* (Alicante: Diputación Provincial de Alicante, Instituto Alicantino de Cultura Juan Gil-Albert, 1990), pp. 101–36.
- Chacón Jiménez, F., 'Notas para una reflexión sobre el estado de la cuestión de la historia de la familia en España', in *Vivir el siglo de Oro. Poder, Cultura e Historia en la época Moderna. Estudios en Homenaje al profesor Ángel Rodríguez Sánchez* (Salamanca: Universidad de Salamanca, 2002), pp. 31–47.
- Chacón Jiménez, F., 'Presentación: propuestas teóricas y organización social desde la Historia de la familia en la España Moderna', *Studia Histórica*, 18 (1998), 17–26.
- Chacón Jiménez, F., 'Viejos problemas nuevas situaciones', *Historia de la Región de Murcia*, 5 (1980), pp. 2–14.
- Chacón Jiménez, F. and Irigoyen López, A., De Mesquita Samara, E. and Lozano Armendares, T. (eds), *Sin distancias. Familia y tendencias historiográficas en el siglo XX* (Murcia: Universidad de Murcia-Universidad Externado de Colombia, 2002).
- Chacón Jiménez, F. and Martínez López, J., 'Aproximación al estudio de la Historia Social de la población de Lorca y su comarca durante los siglos XVI y XVII', in F. Chacón Jiménez, J. A. Mula Gómez and F. Calvo García Tornel (eds), *Lorca. Pasado y Presente. Aportaciones a la Historia de la Región de Murcia*, vol. I: *La formación de una comarca histórica: tierras, pueblos y culturas* (Lorca: Ayuntamiento de Lorca-CAM, 1990), pp. 251–73.
- Chant S., and Craske, N., *Gender in Latin America* (New Brunswick: Rutgers University Press 2003).
- Chauchadis, C., 'Les modalités de la fermeture dans les confréries espagnoles, XVIe–XVIIIe siècle', *Les sociétés fermées dans le monde ibérique, XVIe–XVIIIe siècle* (Paris: CNRS, 1986), pp. 83–105.
- Chaussinand-Nogaret, G., *Histoire des élites en France, du XVIe au XXe siècle: l'honneur, le mérite, l'argent* (Paris: Tallandier, 1991).
- Clavero, B., *Mayorazgo. Propiedad feudal en Castilla (1369–1836)* (Madrid: Siglo XXI, 1974).
- Contreras, J., 'Criptojudasísmo en la España Moderna: clientelismo y linaje', *Áreas*, 9 (1988), 77–100.
- Contreras, J., 'Estructuras familiares y linajes en el mundo judeoconverso', in R. Carrasco (ed.), *Solidarités et sociabilités en Espagne*

- (XVIe–XXe siècles) (Paris: Annales Littéraires de l'Université de Besançon, 1991), pp. 187–241.
- Contreras, J., 'Historiar a los judíos de España: un asunto de pueblo, nación y etnia', in A. Mestre Sanchís and E. Giménez López (eds), *Disidencias y exilios en la España Moderna* (Alicante: Universidad de Alicante, 1997), pp. 117–44.
- Contreras, J., 'La infraestructura social de la Inquisición: comisarios y familiares', in A. Alcalá et al. (eds), *Inquisición española y mentalidad inquisitorial* (Barcelona: Editorial Aries, 1984), pp. 123–46.
- Contreras, J., 'Limpieza de sangre: los discursos de la retórica y la importancia de las realidades', in E. Belenguier Cebriá (ed.), *Felipe II y el Mediterráneo*, vol. 2 (Madrid: Sociedad Estatal para la Conmemoración de los Centenarios de Felipe II y Carlos V, 1999), pp. 481–501.
- Contreras, J., 'Linajes y cambio social: la manipulación de la memoria', *Historia Social*, 21 (1995), 105–24.
- Contreras, J., 'Procesos culturales hegemónicos: de la religión y religiosidad en la España del Antiguo Régimen', *Historia Social*, 35 (1999), 3–22.
- Contreras, J., *Sotos contra Riquelmes: regidores, inquisidores y criptojudíos* (Madrid: Anaya & Mario Muchnik, 1992).
- Corteguera, L. R., *Death by Effigy: A Case from the Mexican Inquisition* (Philadelphia: University of Pennsylvania Press, 2012).
- Costa, L. F. and da Cunha, M. S., *D. João IV* (Lisbon: Círculo de Leitores, 2006).
- Cruz, J., *Los notables de Madrid. Las bases sociales de la evolución liberal española* (Madrid: Alianza, 2000).
- Cuart Moner, B., "Familias colegiales" y familias de colegiales: fuentes y metodología para el estudio de una elite de poder', in Hernández Franco, J. (ed.), *Familia y poder. Sistemas de reproducción social en España (Siglos XVI–XVIII)* (Murcia: Universidad de Murcia, 1995), pp. 49–79.
- Cuart Moner, B., *Colegios Mayores y limpieza de sangre durante la Edad Moderna. El estatuto de S. Clemente de Bolonia (Siglos XV–XIX)* (Salamanca: Universidad de Salamanca, 1991).
- Cunha, M. S., *A Casa de Bragança (1560–1640). Práticas Senhoriais e Redes Clientelares* (Lisbon: Editorial Estampa, 2000).
- Dacosta Martínez, A., 'Ser hidalgo en la Vizcaya bajomedieval. Fundamentos de un imaginario colectivo', in I. Reguera and R. Porres (eds), *Poder, pensamiento y cultura en el Antiguo Régimen. Actas de la 1ª semana de Estudios Históricos de 'Noble Villa de Portugalete'* (San Sebastián: Eusko Ikaskuntza, 2002), pp. 15–32.
- Dacosta Martínez, A., *Los linajes de Vizcaya en la Baja Edad Media: poder, parentesco y conflicto* (Bilbao: UPV/EHU, 2004).

- Dacre Boulton, D. J., *The Knights of the Crown: The Monarchical Orders of Knighthood in Later Medieval Europe, 1325–1520* (Woodbridge: Boydell Press, 1987).
- de Dios, S., *Gracia, merced y patronazgo real: la Cámara de Castilla entre 1474 y 1530* (Madrid: Centro de Estudios Constitucionales, 1982).
- de la Válgoma y Díaz-Varela, D., *Los Saavedra y los Fajardo en Murcia* (Murcia: Academia Alfonso X el Sabio, 1957).
- de Moxó, S., 'De la vieja nobleza a la nueva. La transformación nobiliaria castellana en la Baja Edad Media', *Cuadernos de Historia. Anexos de la revista Hispania*, 3 (1969), 1–210.
- de Sousa, L., *The Jewish Diaspora and the Perez Family Case in China, Japan, the Philippines, and the Americas (16th Century)* (Macau: Fundação Macau, 2015).
- de Sousa, L., *The Portuguese Slave Trade in Early Modern Japan Merchants, Jesuits and Japanese, Chinese, and Korean Slaves* (Leiden: Brill, 2018).
- Dedieu, J. P., 'Familias, mayorazgos, redes de poder. Extremadura, siglos XV–XVIII', in J. L. Castellano and J. P. Dedieu (eds), *Réseaux, familles et pouvoirs dans le monde ibérique à la fin de l'Ancien Régime* (Paris: CNRS, 1998), pp. 107–18.
- Dedieu, J. P., 'Les causes de foi de l'Inquisition de Tolède (1483–1820). Essai statistique', *Mélanges de la Casa Velázquez*, 14 (1978), 143–71.
- Dedieu, J. P., '¿Pecado original o pecado social? Reflexiones en torno a la constitución y a la definición del grupo judeoconverso en Castilla', *Manuscrits*, 10 (1992), 61–76.
- Delille, G., 'Consanguinité proche en Italie du XVIe au XIXe siècle', in *Épouser au plus proche. Inceste, prohibitions et stratégies matrimoniales autour de la Méditerranée* (Paris: EHESS, 1994), pp. 323–67.
- Delille, G., *Famille et propriété dans le Royaume de Naples, XVe–XIXe siècle* (Paris: EHESS, 1988).
- Delille, G., 'La historia de la familia en Italia: trabajos recientes y problemas metodológicos', in F. Chacón Jiménez (ed.), *Familia y sociedad en el Mediterráneo Occidental. Siglos XV–XIX*, (Murcia: Universidad de Murcia, 1987), pp. 263–78.
- Delille, G., *Le maire et le prieur. Pouvoir central et pouvoir local en Méditerranée occidentale (XVe–XVIIe siècle)* (Rome: École Française de Rome, 2003).
- Delille, G., 'Storia politica e antropología: gruppi di potere locale nel Mediterraneo occidentale dal XVe al XVII secolo', *L'Uomo*, 7/1–2 (1994), 132–55.
- Descimon, R., 'Chercher des nouvelles voies pour interpréter les phénomènes nobiliaires dans la France moderne. La noblesse, "essence" ou rapport social?', *Revue d'Histoire Moderne et Contemporaine*, 46/1 (1999), 8–17.

- Devis Márquez, F., *Mayorazgo y cambio político: estudios sobre el mayorazgo de la casa de Arcos al final de la Edad Media* (Cádiz: Universidad de Cádiz, 1999).
- Devver, A., *Le sang épuré. Les préjugés de race chez les gentilhommes français de l'Ancien Régime (1560–1720)* (Brussels: Éditions de l'Université de Bruxelles, 1973).
- Diago Hernando, M., 'Estructuras familiares de la nobleza urbana en la Castilla bajomedieval: los doce linajes de Soria', *Studia Stórica-Historia Medieval*, 10 (1992), 47–71.
- Díaz de Durana, J. R. (ed.), *La lucha de bandos en el País Vasco: de los Parientes Mayores a la Hidalguía Universal (Siglos XIV–XVI)* (Bilbao: UPV/EHU, 1998).
- Díaz de Durana, J. R., *La otra nobleza, escuderos e hidalgos sin nombre y sin historia: hidalgos e hidalguía universal en el País Vasco al final de la Edad Media (1250–1525)* (Bilbao: UPV/EHU, 2004).
- Díaz de Durana, J. R. and Reguera, I. (eds), *Lope García de Salazar: banderizo y cronista. Actas de las II Jornadas de Estudios Históricos 'Noble Villa de Portugalete'* (Portugaleta: Ayuntamiento de Portugaleta, 2002).
- Disney, A. R., *A History of Portugal and the Portuguese Empire* (Cambridge: Cambridge University Press, 2009).
- Domínguez Nafría, J. C., *La Inquisición de Murcia en el siglo XVI: el licenciado Cascales* (Murcia: Academia Alfonso X el Sabio, 1991).
- Domínguez Nafría, J. C., 'La nobleza en el Reino de Murcia', in M. C. Iglesias Cano (ed.), *Nobleza y sociedad III: las noblezas españolas, reinos y señoríos en la Edad Moderna* (Oviedo: Nobel, 1999), pp. 101–43.
- Domínguez Ortiz, A., *La sociedad española del siglo XVIII* (Madrid: Ariel, 1955).
- Domínguez Ortiz, A., *Las clases privilegiadas en el Antiguo Régimen* (Madrid: Istmo, 1973).
- Domínguez Ortiz, A., *Los judeoconversos en la España Moderna* (Madrid: Editorial MAPFRE, 1992).
- Dong, H., Campbell, C. Kurosu and Lee, J., 'Household context and individual departure: The case of escape in three "Unfree" East Asian Populations, 1700–1900', *Chinese Journal of Sociology*, 1/4 (2015), 515–39.
- Duby, G., 'Estructuras de parentesco y nobleza en la Francia del Norte en los siglos X y XI', in G. Duby, A. R. Firpo and R. Pastor (eds), *Hombres y estructuras de la Edad Media* (Mexico City: Siglo Veintiuno Editores, 2000), pp.162–83.
- Duby, G., 'La diffusion du titre chevaleresque sur le versant méditerranéen de la Chrétienté latine', in P. Contamine (ed.), *La noblesse au Moyen Âge (XIe–XVe siècles)* (Paris: Presses Universitaires de France, 1976), pp. 39–70.

- Ebaugh, H. R. and Curry, M., 'Fictive kin as social capital in new immigrant communities', *Sociological Perspectives*, 43/2 (2000), 18–209.
- Elliott, J. H., *España y su mundo 1500–1700* (Madrid: Alianza Editorial, 1990).
- Elliott, J. H., *La España Imperial (1469–1716)* (Barcelona: Vicens Vives, 1998).
- Elliott, J. H., *The Count-Duke of Olivares. The Statesman in an Age of Decline* (New Haven and London: Yale University Press, 1986).
- Fernández Cortizo, C., 'Espacios matrimoniales y reproducción social en la Galicia Occidental del siglo XVIII', *Revista de Demografía Histórica*, 22/1 (2004), 77–109.
- Fernández de Pinedo, E., *Crecimiento económico y transformaciones sociales del País Vasco* (Madrid: Siglo XXI, 1974).
- Fernández Izquierdo, F., 'La Orden de Calatrava en la Edad Moderna', in *Las Órdenes Militares en el Mediterráneo Occidental (Siglos XIII–VIII)* (Madrid: Casa de Velázquez, 1989), pp. 181–212.
- Ferrer i Alós, L., 'Estrategias familiares y formas jurídicas de transmisión de la propiedad y el estatus social', *Boletín de la Asociación de Demografía Histórica*, 10/3 (1992), 9–14.
- Fontes Fuster, E., *Nuestra heráldica (Historia de la familia Fontes y otras enlazadas con ella)* (Murcia: M. Arenas, 1936).
- Fortea, J. I., *Las Cortes de Castilla y León bajo los Austrias: una interpretación* (Valladolid: Junta de Castilla y León, 2008).
- Fray Agustín Salucio, *Discurso acerca de la injusticia y buen gobierno de España, en los estatutos de limpieza de sangre, y si conviene, o no, alguna limitación en ellos, s.d.* (Cieza: A. Pérez Gómez, 1975).
- Galende Díaz, J. C., 'La Cofradía de S. Pedro Mártir en los Tribunales Inquisitoriales del Levante español: Valencia y Murcia', in *Religiosidad popular en España* (San Lorenzo del Escorial: Real Centro Universitario Escorial-María Cristina, 1997), pp. 1007–26.
- García Cárcel, R., 'Número y sociología de los familiares de la Inquisición valenciana', in J. Pérez Villanueva (ed.), *La Inquisición española. Nueva visión, nuevos horizontes* (Madrid: Siglo XXI, 1980), pp. 271–84.
- García de Medrano, *La regla y establecimiento de la cavallería de Santiago de la Espada. Con la Historia del origen y principio della.* (1627; second edn Madrid: Facsímil, 1991).
- García Díaz, I., 'La política caballerescas de Alfonso XI', *Miscelánea Medieval*, 11 (1984), 119–33.
- García Fernández, E. (ed.), *Poder en Europa y América, mitos, tópicos y realidades* (Bilbao: UPV/EHU, 2004).
- García Fernández, M., 'Herederos y beneficiarios. Igualdad hereditaria o heredar lo mismo', in A. Irigoyen López and A. L. Pérez Ortiz (eds),



- Familia, transmisión y perpetuación (Siglos XVI–XIX)* (Murcia: Universidad de Murcia, 2002), pp. 135–48.
- García Marín, J. M., *El oficio público en Castilla durante la Baja Edad Media* (Madrid: Instituto Nacional Administración Pública, 1987).
- García-Guijarro Ramos, L., 'Los orígenes de la Orden de Montesa', in *Las órdenes militares en el Mediterráneo occidental (Siglos XII–XVIII)* (Madrid: Casa de Velázquez, 1989), pp. 69–83.
- Gerbet, M. C., 'Les confréries religieuses à Cáceres de 1467 à 1523', *Mélanges de la Casa Velázquez*, 7, (1971), 79–113.
- Gerbet, M. C., *La nobleza en la Corona de Castilla: Sus estructuras sociales en Extremadura (1454–1516)* (Cáceres: Diputación Provincial de Cáceres, Institución Cultural El Brocense, 1989).
- Gil Soto, A., *Deudos, parciales y consortes. Estrategias políticas y sociales de la oligarquía rural extremeña (Siglos XVII y XVIII)* (Cáceres: Universidad de Extremadura, 2003).
- Ginzburg, C., *The Cheese and the Worms: The Cosmos of a Sixteenth-Century Miller* (Baltimore: Johns Hopkins University Press, 1992).
- Glick, T. F., *Irrigation and Society in Medieval Valencia* (Cambridge, MA: Harvard University Press, 1970).
- Godinho, V. M., *Os descobrimentos e a Economia Mundial* (Lisbon: Arcadia, 1963).
- Gómez Martín, M., 'Dote y herencia en la Vega de Granada. Alfacar en el siglo XVIII', in M. V. López Cordón and M. Carbonell Esteller (eds), *Historia de la mujer e historia del matrimonio* (Murcia: Universidad de Murcia, 1997), pp. 183–90.
- Gonzalbo Aizpuru, P., *Familia y orden colonial* (Ciudad de México: El Colegio de México, 1998).
- Goody, J., *The Development of the Family and Marriage in Europe* (Cambridge: Cambridge University Press, 1983).
- Gribaudi, M., 'Réseaux égocentrés et inscriptions sociales. Continuités et discontinuités dans les formes de structuration de l'espace parisien', in M. Gribaudi (ed.), *Espaces Temporalités Stratifications. Exercices sur les réseaux sociaux* (Paris: Éditions de l'École des Hautes Études en Sciences Sociales, 1998), pp. 71–120.
- Guerreau-Jalabert, A., 'Prohibitions canoniques et stratégies matrimoniales dans l'aristocratie médiévale de la France du Nord', in P. Bonte (ed.), *Épouser au plus proche. Inceste, prohibitions et stratégies matrimoniales autour de la Méditerranée* (Paris: Éditions de l'École des Hautes Études en Sciences Sociales, 1994), pp. 293–321.
- Guichard, P., *Al-Andalus frente a la conquista cristiana. Los musulmanes de Valencia (Siglos XI–XIII)* (Valencia: Biblioteca Nueva, Universidad de Valencia, 2001).
- Guillamón Álvarez, F. J., *Honor y honra en la España del siglo XVIII* (Madrid: Universidad Complutense, 1981).

- Guillamón Álvarez, F. J., *Regidores de la ciudad de Murcia (1750–1836)* (Murcia: Academia Alfonso X el Sabio, 1989).
- Gutiérrez Alonso, A., 'Consideraciones sobre el matrimonio y la familia de una elite de poder: los regidores de Valladolid (1606–1808)', in J. Casey and J. Hernández Franco (eds), *Familia, linaje y parentesco* (Murcia: Universidad de Murcia, 1997), pp. 269–76.
- Gutiérrez Nieto, J. I., 'La estructura castizo-estamental de la sociedad castellana del siglo XVI', *Hispania*, 125 (1973), 519–63.
- Harenven, T. K., 'Historia de la familia y la complejidad del cambio social', *Boletín de la ADEH*, 13/1 (1995), 99–149.
- Heers, J., *Hommage à Roland Mousnier, Clientèles et fidélités en Europe à l'époque moderne*, (Paris: P.U.F., 1981).
- Heers, J., *Le clan familial au Moyen Âge* (Paris: P.U.F., 1974).
- Heers, J., *Les partis et la vie politique dans l'Occident médiéval* (Paris: P.U.F., 1981).
- Hernández, M., 'Sobre familias, relaciones y estrategias familiares en una elite ciudadana (los regidores de Madrid, siglos XVI–XVIII)', in F. Chacón Jiménez and J. Hernández Franco, *Familia, poderosos y oligarquías* (Murcia: Universidad de Murcia, 2001), pp. 61–80.
- Hernández Franco, J., 'Consideraciones y propuestas sobre linaje y parentesco', in J. Casey and J. Hernández Franco (eds), *Familia, parentesco y linaje. Historia de la familia, una nueva perspectiva sobre la sociedad europea* (Murcia: Universidad de Murcia, 1997), pp. 19–29.
- Hernández Franco, J., 'Cultura de elites y estratificación social en la España Moderna. Aproximación metodológica a través de los estatutos e informaciones de limpieza de sangre', in J. Hernández Franco (ed.), *Familia y poder. Sistemas de reproducción social en España (Siglos XVI–XVIII)* (Murcia: Universidad de Murcia, 1995), pp. 81–99.
- Hernández Franco, J., *Cultura y limpieza de sangre en la España Moderna. Puritate sanguinis* (Murcia: Universidad de Murcia, 1996).
- Hernández Franco, J., 'El 'consentimiento' del Emperador a los estatutos de limpieza de sangre y el comienzo del viraje hacia la Monarquía Católica', in J. L. Castellano Castellano and F. Sánchez Montes (eds), *Europeísmo y universalidad*, vol. 4 (Madrid: Sociedad Estatal para la Conmemoración de los Centenarios de Felipe II y Carlos V, 2001), pp. 365–86.
- Hernández Franco, J., 'El mayorazgo Moctezuma: reflexiones sobre un proceso de movilidad vertical con alternancias (1509–1807)', *Estudis: Revista de historia moderna*, 32 (2006), 215–36.
- Hernández Franco, J., 'El partido de los cristianos viejos establece el estatuto de limpieza de sangre el año 1544 en el Cabildo Catedral de Murcia', *Murgetana*, 103 (2000), 57–70.
- Hernández Franco, J., 'El pecado de los padres: construcción de la identidad conversa en Castilla a partir de los discursos sobre limpieza de sangre', *Hispania*, 64, 217 (2004), 515–42.

- Hernández Franco, J., 'Trayectoria social de una familia conversa: los Santesteva-Lara. Del empinamiento a la condena', in *Disidencias y exilios en la España Moderna* (Alicante: Publicaciones de la Universidad de Alicante-AHME, 1997), pp. 179–92.
- Hernández Franco, J. and Jiménez Alcázar, J. F., 'Estado, aristocracia y oligarquías urbanas en el Reino de Murcia. Un punto de flexión en torno a las comunidades de Castilla', *Chronica Nova*, 23 (1996), 171–87.
- Hernández Franco, J. and Montojo y Montojo, V., 'Cultura del honor, linaje-patrón y movilidad social en Cartagena durante los siglos XVI y XVII', *Hispania*, 53/185 (1993), 1009–30.
- Hernández Franco, J. and Ruíz Ibáñez, J. J., 'Conflictividad social en torno a la limpieza de sangre en la España Moderna', *Investigaciones Históricas*, 23 (2003), 35–56.
- Herzog, T., *Frontiers of Possession: Spain and Portugal in Europe and the Americas* (Cambridge MA: Harvard University Press, 2015).
- Hespanha, A. M., *História de Portugal. O Antigo Regime (1620–1807)* (Lisbon: Círculo de Leitores, 1993).
- Hespanha, A. M., *La gracia del Derecho* (Madrid: Centro de Estudios Constitucionales, 1993).
- Hespanha, A. M., *Vísperas del Leviatán. Instituciones y poder político* (Portugal siglo XVII) (Madrid: Taurus, 1989).
- Hill, R. R., *The Office of Adelantado* (New York: Ginn & Company, 1913).
- Holt, M. P., *The French Wars of Religion, 1562–1629* (Cambridge: Cambridge University Press, 1995).
- Imízcoz Beunza, J. M., 'Patronos y mediadores. Redes familiares en la monarquía y patronazgo en la aldea: la hegemonía de las elites baztanesas en el siglo XVIII', in J. M. Imízcoz Beunza (ed.), *Redes familiares y patronazgo. Aproximación al entramado social del País Vasco y Navarra en el Antiguo Régimen (Siglos XV–XIX)* (Bilbao: Universidad del País Vasco, 2001), pp. 225–61.
- Imízcoz Beunza, J. M., *Elites, poder y red social. Las elites del País Vasco y Navarra en la Edad Moderna* (Bilbao: Universidad del País Vasco, 1996).
- Iradriel, P., 'Formas de poder y de organización de la sociedad en las ciudades castellanas de la Baja Edad Media', in R. Pastor, I. Kieniewicz, E. García de Enterría et al. (eds), *Estructuras y formas del poder en la Historia* (Salamanca: Ediciones Universidad de Salamanca, 1991), pp. 23–49.
- Irigoyen López, A., 'Clero secular, familia y movilidad social: actores y directores', in F. Chacón Jiménez and J. Hernández Franco (eds), *Familia, poderosos y oligarquías* (Murcia: Universidad de Murcia, 2001), pp. 131–52.

- Irigoyen López, A., *Entre el cielo y la tierra, entre la familia y la institución. El cabildo de la catedral de Murcia en el siglo XVII* (Murcia: Universidad de Murcia, 2000).
- Israel, J. I., *Empires and Entrepreneurs. The Dutch, the Spanish Monarchy and the Jews, 1585–1713* (London: The Hambledon Press, 1990).
- Israel, J. I., *The Dutch Republic: Its Rise, Greatness, and Fall 1477–1806* (Oxford: Clarendon Press, 1995).
- Israel, J. I., *The European Jewry in the Age of Mercantilism* (Oxford: Clarendon Press, 1985).
- Janssens, A., *Family and Social Change. The Household as a Process in an Industrializing Community* (Cambridge: Cambridge University Press, 1993).
- Janssens, A., 'The History of Male Breadwinning: A Story about Economics, Power, and Identity', in J. Ehmer, H. Grebing and P. Gutschner (eds), *Arbeit: Geschichte – Gegenwart – Zukunft* (Vienna: Akademische Verlagsanstalt, 2002), pp. 101–18.
- Jiménez Alcázar, J. F., *Agua y poder en Lorca durante la Baja Edad Media* (Murcia: Universidad de Murcia, 1996).
- Jiménez Alcázar, J. F., 'Territorio y frontera en el Reino de Murcia durante la Baja Edad Media', *Yakka*, 5 (1994), 25–9.
- Jiménez Alcázar, J. F., *Un concejo de Castilla en la frontera de Granada: Lorca 1460–1521* (Granada: Universidad de Granada, 1997).
- Jiménez Alcázar, J. F. and López Bermúdez, F., *Sequía, aridez y desertificación en Murcia* (Murcia: Academia Alfonso X el Sabio, 1985).
- Johansen, H.C., 'Urban Social and Demographic Reconstitution. The Case of Eighteenth Century Odense', *History and Computing*, 11 (1999), 115–28.
- Jonathan, R., *The Sephardic Frontier: The Reconquista and the Jewish Community in Medieval Iberia* (Ithaca and London: Cornell University Press, 2006).
- Jouanna, A., 'De "gross et grass" aux "gens d'honneur"', in G. Chaussinaud-Nogaret (ed.), *Histoire des élites en France du XVIe au XXe siècle* (Paris: Tallandier, 1991), pp. 15–141.
- Jouanna, A., *Ordre social. Mythes et hiérarchies dans la France du XVIe siècle* (Paris: Hachette, 1977).
- Kagan, R., *Pleitos y pleiteantes en Castilla* (Salamanca: Junta de Castilla y León, 1991).
- Kagan, R. and Dyer, A., *Inquisitorial Inquiries. Brief Lives and Other Heretics* (Baltimore: Johns Hopkins University Press, 2004).
- Kamen, H., 'Una crisis de conciencia en la Edad de Oro en España: Inquisición contra limpieza de sangre', *Bulletin Hispanique*, 88/3–4 (1986), 321–35.

- Kamen, H., *Spain, 1469–1714: A Society of Conflict* (London: Routledge, 2014).
- Kamen, H., *The Spanish Inquisition: A Historical Revision* (New Haven and London: Yale University Press, 2014).
- Kaplisch Zuber, C., *La famiglia e le donne a Firenze nel Rinascimento* (Bari: Laterza, 1989).
- King, S. A., 'Historical demography, life-cycle, reconstruction and family reconstitution: New perspectives', *History and Computing*, 8/2 (1996), 62–77.
- King, S. A., 'Multiple Source Record Linkage in a Rural Industrial Community, 1680–1820', *History and Computing*, 6 (1994), 133–42.
- Koenigsberger, H. G., *Politicians and Virtuosi: Essays in Early Modern History* (London: Bloomsbury, 1986).
- Koenigsberger, H. G., *The Habsburgs and Europe, 1516–1660* (Ithaca: Cornell University Press, 1971).
- Kok, J., 'Church Affiliation and Life Course Transitions in The Netherlands, 1850–1970', *Historical Social Research*, 42/2 (2017), 59–91.
- Kok, J., 'Principles and Prospects of the Life Course Paradigm', *Annales de Démographie Historique*, 1 (2007), 203–30.
- Kok, J. and Mandemakers, K., 'Life and Death of Singles in Dutch Cities, 1850–1940', *Journal of Urban History*, 21/1 (2016), 101–20.
- Ladero Quesada, M. A., 'Corona y ciudades en la Castilla del siglo XV', *España Medieval*, 5 (1986), 551–74.
- Ladero Quesada, M. A., 'Linajes, bandos y parcialidades en la vida política de las ciudades castellanas (Siglos XIV y XV)', in *Actas Coloquio celebrado en la Biblioteca Española de París* (1987) (Madrid: Ministerio de Asuntos Exteriores, 1991), pp. 105–34.
- Lambert-Gorges, M., 'Imágenes de la familia y de la respetabilidad social a través de las encuestas de las Órdenes Militares', in J. Hernández Franco (ed.), *Familia y poder. Sistemas de reproducción social en España (Siglos XVI–XVIII)* (Murcia: Universidad de Murcia, 1995), pp. 49–79.
- Lambert-Gorges, M., 'Le bréviaire du bon enquêteur, ou trois siècles d'information sur les candidats à l'habit des ordres militaires', *Mélanges de la Casa Velázquez*, 18 (1982), 165–98.
- Laslett, P., 'Age at Menarche in Europe since the Eighteenth Century', *Journal of Interdisciplinary History* 2/2, *The History of the Family* (Autumn 1971), 221–36.
- Laslett, P., 'The Character of Familial History, its Limitations and the Conditions for its Proper Pursuit', *Journal of Family History*, 12 (1987), 263–84.
- Laslett, P. and Wall, R., *Household and Family in Past Time* (Cambridge: Cambridge University Press, 1972).

- Lema, J. A., Fernández de Larrea, J. A., García, E., Larrañaga, M., Munita, J. A. and Díaz de Durana, J. R., *El triunfo de las elites urbanas guipuzcoanas: Nuevos textos para el estudio del gobierno de nuevas villas y de la provincia (1412–1539)* (Donostia-San Sebastián: Diputación Foral de Guipúzcoa, 2002).
- Lemeunier, G., 'Des gens belliqueux et à l'âme altière. Sur les bandos murciens de l'époque moderne', in R. Carrasco, *Solidarités et socialibilités en Espagne (XVIe–XXe siècles)* (Paris: Annales Littéraires de l'Université de Besançon, 1991), pp. 277–96.
- Lemeunier, G., 'El régimen señorial en la sociedad murciana de la época moderna', *Áreas*, 10 (1989), 113–15.
- Lemeunier, G., *Los señoríos murcianos, siglos XVI–XVIII* (Murcia: Universidad de Murcia, 1998).
- Lemeunier, G., 'Propiedad y economía agraria en Lorca (Siglos XVI–XVIII)', in F. Chacón Jiménez, J. A. Mula Gómez and F. Calvo García Tornel (eds), *Lorca. Pasado y Presente. Aportaciones a la Historia de la Región de Murcia*, vol. I: *La formación de una comarca histórica: tierras, pueblos y culturas* (Lorca: Ayuntamiento de Lorca-CAM, 1990), pp. 275–83.
- Lemeunier, G. and Gonzalez Castaño, J., 'Señores y oligarcas. Las luchas políticas en Mula durante los siglos XVI y XVII', *Áreas*, 10 (1989), 119–44.
- Lemeunier, G. and Pérez Picazo, M. T., 'Cens emfitèutic i colonització agrícola a Murcia (1450–1900)', *Estudis d'Historia Agraria*, 7 (1988), 51–7.
- Lenclud, G., 'Mariage, transmission des biens et reproduction sociale dans la Corse traditionnelle', in F. Heritier-Auge and E. Copet-Rougier (eds), *Les complexités de l'alliance. Les systèmes complexes d'alliance matrimoniale*, 2 (Paris: Éditions des Archives Contemporaines, 1991), pp. 147–76.
- Lepetit, B., 'Architecture, géographie, histoire: usages de l'échelle', *Genèses*, 13 (1993), 118–38.
- Leverenz, I., 'Società segmentaria', in B. Streck (ed.), *Dizionario di etnologia* (Milan: Sugarco Edizioni, 1987), pp. 232–4.
- Levi, G., *L'eredità immateriale: carriera di un esorcista nel Piemonte del Seicento* (Turin: Giulio Einaudi, 1985).
- López Cordón, M. V. and Carbonell Esteller, M. (eds), *Historia de la mujer e Historia del matrimonio* (Murcia: Universidad de Murcia, 1997).
- López González, C., Postigo Castellanos, E. and Ruiz Rodríguez, J. I., 'Las órdenes Militares castellanas en la época Moderna: una aproximación cartográfica', in *Las Órdenes Militares en el Mediterráneo Occidental (Siglos XII–XVIII)* (Madrid: Casa de Velázquez, 1989), pp. 291–340.

- López-Salazar Pérez, J., 'Limpieza de sangre y división en estados: el municipio de Almagro durante el siglo XVI', *Studia Historica. Historia Moderna*, 12 (1994), 157–87.
- Lynn, K., *Between Court and Confessional: The Politics of Spanish Inquisitors* (New York: Cambridge University Press, 2013).
- MacFarlane, A., *Marriage and Love in England, 1300–1840* (Oxford: Blackwell, 1987).
- Maczak, A., 'From aristocratic household to princely court. Restructuring patronage in the sixteenth and seventeenth centuries', in R. G. Asch and A. M. Birke (eds), *Princes, Patronage and the Nobility: The Court at the Beginning of the Modern Age* (London: The German Historical Institute, Oxford University Press, 1991), pp. 315–27.
- Maczak, A., *Klientelssysteme in Europa der frühen Neuzeit*, Schriften des Historischen Kollegs, Kolloquien 9 (Munich: De Gruyter Oldenbourg, 1988).
- Major, J. R., "'Bastard Feudalism" and the kiss: Changing social mores in late medieval and early modern France', *Journal of Interdisciplinary History*, 27 (1987), 509–35.
- Malanima, P., *La fine del primato. Crisi e riconversione nell'Italia del Seicento* (Milan: Mondadori, 1998).
- Maravall, J. A., *La cultura del Barroco* (Barcelona: Ariel, 1986).
- Maravall, J. A., *Poder, honor y elites en el siglo XVII* (Madrid: Siglo XXI, 1984).
- Martínez Bara, J. A., 'Los actos positivos y su valor en las pruebas genealógicas y nobiliarias en el siglo XVII', in J. Pérez Villanueva (ed.), *La Inquisición española. Nueva visión, nuevos horizontes* (Madrid: Siglo XXI, 1980), pp. 303–18.
- Martínez Carrillo, M. Ll., 'El padrón de cuantiosos murcianos de 1374', *Miscelánea Medieval Murciana*, 11 (1984), 239–60.
- Martínez Carrillo, M. Ll., *Manuales y Fajardos. La crisis bajomedieval en Murcia* (Murcia: Academia Alfonso X el Sabio, 1985).
- Martínez Carrillo, M. Ll., 'Reconstrucciones familiares a través de documentos conejiles: los Riquelme murcianos', in V. Montojo y Montojo (ed.), *Linaje, familia y marginación en España (Siglos XIII–XIX)* (Murcia: Universidad de Murcia, 1992), pp. 9–37.
- Martínez Rueda, F., 'Poder local y oligarquías en el País Vasco: las estrategias del grupo dominante en la comunidad tradicional', in J. M. Imízcoz Beunza (ed.), *Elites, poder y red social* (Bilbao: Universidad del País Vasco, 1996), pp. 119–46.
- Martz, L., 'Pure blood statutes in Sixteenth Century Toledo: Implementation as opposed to adoption', *Sepharad*, 54/1 (1994), 83–108.
- Mauss, M., 'Ensayo sobre los dones', *Sociología y Antropología* (1979), 153–263.
- Mauss, M., *The Gift: Forms and Functions of Exchange in Archaic Societies* (London: Routledge, 2006).

- Merino Álvarez, A., *Geografía histórica del territorio de la actual provincia de Murcia: desde la reconquista por Jaime I de Aragón hasta el presente* (Murcia: Academia Alfonso X el Sabio, 1978).
- Meyerson, D. and English, D., *Christians, Muslims, and Jews in Medieval and Early Modern Spain: Interaction and Cultural Change* (Notre Dame: University of Notre Dame Press, 2000).
- Molina Molina, A. L., 'Aportación para un estudio económico de Enrique II: Murcia', *Miscelánea Medieval Murciana*, 2 (1976), 169–226.
- Molina Recio, R., *Los señores de la Casa del Bailío. La elite local castellana (Córdoba, siglos XV–XIX)* (Córdoba: Diputación de Córdoba, 2002).
- Monteiro, N. G., '17th and 18th century Portuguese Nobilities in the European Context: A historiographical overview', *e-Journal of Portuguese History*, 1 (2003), 1–15.
- Moreno Almarcegui, A., *El origen histórico de un sistema de heredero único. El prepirineo navarro (1540–1739)* (Navarra: Universidad de Navarra, 1999).
- Moreno Almarcegui, A., 'Pequeña nobleza rural, sistema de herencia y estructura de la propiedad de la tierra en Plasencia del Monte (Huesca), 1600–1855', in F. Chacón Jiménez and J. Hernández Franco (eds), *Poder, familia y consanguineidad en la España del Antiguo Régimen* (Barcelona: Anthropos, 1992), pp. 71–106.
- Munita Loinaz, J. A. (ed.), *Conflicto, violencia y criminalidad en Europa y América* (Bilbao: UPV/EHU, 2004).
- Muñoz Clarés, M., 'El encargo de pintura en Lorca: los ciclos heroicos municipales', in F. Chacón Jiménez, J. Mula Gómez and F. Calvo García Tornel (eds), *Lorca. Pasado y Presente. Aportaciones a la Historia de la Región de Murcia*, vol. I: *La formación de una comarca histórica. Tierras, pueblos y culturas* (Lorca: Ayuntamiento de Lorca-CAM, 1990), pp. 93–106.
- Muto, G., 'Famiglia e Storia Sociale', *Studia Histórica*, 18 (1998), 55–66.
- Norbert, E. (ed.), *Conocimiento y poder* (Madrid: Las Ediciones de la Piqueta, 1994).
- O'Callaghan, J. F., *Alfonso X, the Justinian of His Age: Law and Justice in Thirteenth Century Castile* (Ithaca and London: Cornell University Press, 2019).
- O'Day, R., 'The household life-cycle', in R. O'Day (ed.), *The Family and Relationships, 1500–1900: England, France and the United States of America* (London: Macmillan, 1994), pp. 11–19.
- Ogilvie, S., *Institutions and European Trade: Merchant Guilds, 1000–1800* (Cambridge: Cambridge University Press, 2011).
- Olival, F., 'Economía de la merced y venalidad en Portugal (Siglos XVII y XVIII)', in F. Andújar Castillo, M. M., Felices de la Fuente (eds), *El poder del dinero: Ventas de cargos y honores en el Antiguo Régimen* (Madrid: Siglo XXI, 2011), pp. 345–57.



- Owens, J. B., *By my Absolute Royal Authority: Justice and the Castilian Commonwealth at the Beginning of the First Global Age* (Rochester, NY: University of Rochester Press, 2005).
- Owens, J. B., 'La oligarquía murciana en la defensa de su posición: 1570–1650', *Historia de la Región de Murcia*, 6 (1980), 236–61.
- Owens, J. B., 'Los regidores y jurados de Murcia: 1500–1650: una guía', *Anales de la Universidad de Murcia*, 38/3 (1979–80), 95–150.
- Owens, J. B., *Rebelión, monarquía y oligarquía murciana en la época de Carlos V* (Murcia: Universidad de Murcia, 1980).
- Owens, J. B., 'Situación social poder político en Murcia, 1490–1570', *Historia de la Región de Murcia*, 5 (1980), pp. 22–34.
- Palos, J. L., 'Eleonora Álvarez de Toledo (1522–62): "A Spanish Barbarian and an Enemy of her Husband's Homeland": The Duchess of Florence and her Spanish Entourage', in J. L. Palos and M. Sánchez (eds), *Early Dynastic Marriages and Cultural Transfer* (Farnham: Ashgate, 2016), pp. 165–87.
- Paquette, G. B., 'Empire, Enlightenment and Regalism: New Directions in Eighteenth Century Spanish History', *European History Quarterly*, 35/1 (2005), 107–17.
- Parker, G., *Spain and The Netherlands, 1559–1659* (London: Collins, 1979).
- Pastor, R., *Del Islam al Cristianismo: en las fronteras de dos formaciones económico- sociales: Toledo, siglos XI–XIII* (Barcelona: Península, 1975).
- Pastor, R., *Relaciones de poder, de producción y parentesco en la Edad Media y Moderna* (Madrid: Consejo Superior de Investigaciones Científicas, 1990).
- Peñafiel Ramón, A., *Aproximación al estudio de los testamentos en el siglo XVIII: el murciano ante la muerte* (Murcia: Editora Regional, 1986).
- Peñafiel Ramón, A., 'Costumbres, moral, fieles y clero en la Murcia del obispo Belluga', *Anales de Historia Contemporánea*, 21 (2005), 201–20.
- Peñafiel Ramón, A., *Fiesta y celebración política de los primeros Borbones* (Murcia: Academia Alfonso X el Sabio, 1988).
- Peñafiel Ramón, A., 'Inquisición murciana y reorganización de la Cofradía de S. Pedro Mártir de Verona (Siglo XVIII)', *Revista de la Inquisición*, 9 (2000), 87–100.
- Peñafiel Ramón, A., *Mentalidad y religiosidad popular murciana en la primera mitad del siglo XVIII* (Murcia: Universidad de Murcia, 1988).
- Peñafiel Ramón, A., 'Monjas, visiones y portentos en la España Moderna. Los relatos de confesores', *Contrastes. Revista de Historia Moderna*, 11 (1998–2000), 127–43.
- Peñafiel Ramón, A., 'Notas para el estudio de la organización burocrática inquisitorial: los familiares del Santo Oficio murciano en el siglo XVIII', *Murgetana*, 80 (1990), 29–42.

- Peñafiel Ramón, A., *Testamento y buena muerte: un estudio de las mentalidades en la Murcia del siglo XVIII* (Murcia: Real Academia Alfonso X el Sabio, 1987).
- Peñafiel Ramón, A. and Hernández Franco, J., 'Parentesco, linaje y mayorazgo en una ciudad mediterránea Murcia (Siglos XV–XVIII)', *Hispania*, 58/198 (1998), 157–83.
- Pérez, J., *Breve Historia de la Inquisición en España* (Barcelona: Crítica, 2012).
- Pérez, J., *Isabel y Fernando. Los Reyes Católicos* (Madrid: Nerea, 1988).
- Pérez, J., *La revolución de las comunidades de Castilla (1520–1521)* (Madrid: Siglo XXI, 1970).
- Pérez, J., 'Réflexions sur l'hidalguia', in J. Pérez (ed.), *De l'humanisme aux Lumières. Études sur l'Espagne et l'Amérique* (Madrid: Casa de Velázquez, 2000), pp. 139–48.
- Pérez Balsera, J., *Biblioteca histórica y genealógica. Los caballeros de Santiago*, vol. 3 (Madrid: E. Mestre, 1933).
- Pérez Garzón, J. S., 'El fin de la sociedad estamental', *Torre de los Lujanes*, 28 (1994), 119–32.
- Pérez Moreda, V., 'Matrimonio y familia. Algunas consideraciones sobre el modelo matrimonial español en la Edad Moderna', *Boletín de la Asociación de Demografía Histórica*, 4 (1986), 3–51.
- Pérez Picazo, M. T., *El mayorazgo en la historia económica de la región murciana, expansión, crisis y abolición (Siglos XVII–XIX)* (Murcia: Ministerio de Agricultura, Alimentación y Medio Ambiente, 1990).
- Pérez Villanueva, J. and Escandell Bonet, B. (eds), *Historia de la Inquisición en España y América* (Madrid: Centro de Estudios Inquisitoriales, 1984).
- Pérez-García, M., 'Al servicio de los Fajardo: familia y patronazgo (Siglos XIII–XV)', *Revista Velezana*, 24 (2005), 11–20.
- Pérez-García, M., 'Consumption of Chinese goods in southwestern Europe: a multi-relational database and the vicarious consumption theory as alternative model to the industrious revolution (eighteenth century)', *Historical Methods: A Journal of Quantitative and Interdisciplinary History*, 52 (2019), 15–36.
- Pérez-García, M., 'El pensamiento europeo sobre la revisión y moderación en los estatutos de limpieza de sangre a través de la razón de estado cristiana en tiempos de Felipe IV', *Bulletin for Spanish and Portuguese Historical Studies*, 38/1 (2013), 39–60.
- Pérez-García, M., 'Familia, poder y linaje. Conformación de bandos y surgimiento de luchas en torno a la oligarquía murciana (Siglos XV–XVI)', *VI Congreso Internacional. Las Fronteras. Población y doblamiento. Congreso-Homenaje a Manuel González Jiménez* (Alcalá la Real: Ayuntamiento de Alcalá la Real, 2007), pp. 555–64.

- Perez-García, M., 'Mayorazgo y poder en Baza: el pleito de tenuta entre los Muñoz y los Galiano (Siglo XVIII)', *Péndulo. Revista Miscelánea de difusión cultural*, 6 (2005), 179–88.
- Perez-García, M., 'New technologies applied to family history: A particular case of Southern Europe in the eighteenth century', *Journal of Family History*, 36/3 (2011), 248–62.
- Perez-García, M., 'Servicios en la frontera: el apogeo del linaje de los Riquelme (Siglos XIII–XVI)', *Actas del Congreso-Homenaje a José Rodríguez Molina: Iglesias y Fronteras* (Alcalá la Real: Ayuntamiento de Alcalá la Real, 2004), pp. 613–20.
- Perez-García, M., 'Social Networks and Kinship in Southern Castile: The Clientelistic System in the Kingdom of Murcia (17th–18th Centuries)', *História Unisinos*, 14/3 (2010), 313–29.
- Perez-García, M., 'Trayectoria social de un linaje murciano del siglo XVIII: los Riquelme', in F. A. Chacón Gómez-Monedero, X. Roigé, E. Rodríguez Ocaña (eds), *Familias y poderes: Actas del VII Congreso Internacional de la ADEH*, 2006 (Granada: Universidad de Granada, 2006), pp. 159–72.
- Perez-García, M., *Vicarious Consumers: Trans-National Meetings between the West and East in the Mediterranean World (1730–1808)* (London: Routledge, 2013).
- Perez-García, M., and de Sousa, L., *Global History and New Polycentric Approaches: Europe, Asia and the Americas in a World Network System*, Palgrave Studies in Comparative Global History (Singapore: Palgrave-Macmillan, 2018).
- Perez-García, M. and Hernández Franco, J., "Injuria, calumnia y sangre impure". Banderías y parcialidades desde el Reino de Murcia a Frejenal de la Sierra: el caso de los Paz (Siglos XVI–XVIII)', in *Actas del V Congreso de Historia Social. Las figuras del desorden: heterodoxos, proscritos y marginados* (Ciudad Real, 2005).
- Peristiany, J. G. (ed.), *Dote y matrimonio en los países mediterráneos* (Madrid: Centro de Investigaciones Sociológicas, 1987).
- Pla Alberola, P. J., 'Familia y matrimonio en la Valencia Moderna. Apuntes para su estudio', in P. Vilar (ed.), *La familia en la España mediterránea (Siglos XV–XIX)* (Barcelona: Crítica, 1987), pp. 94–128.
- Po-Chia, H. R., *The World of Catholic Renewal, 1540–1770* (Cambridge: Cambridge University Press, 1998).
- Pomeranz, K., *The Great Divergence: China, Europe, and the Making of the Modern World Economy* (Princeton: Princeton University Press, 2000).
- Postigo Castellanos, E., *Honor y privilegio en la Corona de Castilla. El Consejo de las Ordenes y los caballeros de hábito en el siglo XVII* (Valladolid: Junta de Castilla y León, 1988).

- Prados de la Escosura, L. and Álvarez-Nogal, C., 'The Decline of Spain (1500–1850): Conjectural Estimates', *European Review of Economic History*, 11 (2007), 319–66.
- Pro, J., 'Socios, amigos y compadres: camarillas y redes personales en la sociedad liberal', in F. Chacón Jiménez and J. Hernández Franco (eds), *Familia, poderosos y oligarcas* (Murcia: Universidad de Murcia, 2001), pp. 153–73.
- Pulido Serrano, I., 'Arbitrismo, comercio y conversos. Reflexiones desde el pensamiento político', in J. Contreras, B. J. García García and I. Pulido (eds), *Familia, Religión y Negocio. El sefardísmo en las relaciones entre el mundo ibérico y los Países Bajos en la Edad Moderna* (Madrid: Fundación Carlos de Amberes, Universidad de Alcalá, 2002), pp. 67–94.
- Racine, L., *Théories de l'échange et circulation des produits sociaux* (Quebec: Presses de l'Université de Montréal, 1979).
- Raggio, O., *Faide e parentele. Lo stato genovese visto dalla Fontanabuona*, *Microstorie*, 18 (Turin: Einaudi, 1990).
- Rahner, K. (ed.), *Soberanía, poder y violencia* (Madrid: S.M. cop., 1987).
- Ramos, R., Sousa, B. V. and Monteiro, N. G., *História de Portugal* (Lisbon: Esfera dos Livros, 2009).
- Reher, D. S., 'Family Ties in Western Europe: Persistent Contrasts', *Population and Development Review*, 24 (1998), 203–34.
- Reher, D. S., *Town and Country in Pre-industrial Spain. Cuenca, 1550–1870* (Cambridge: Cambridge University Press, 1990).
- Reilly, B., *The Medieval Spain* (Cambridge: Cambridge University Press, 1993).
- Revel, J., 'L'institution et le social', in B. Lepetit (ed.), *Les formes de l'expérience: une autre histoire sociale* (Paris: Albin Michel, 1995), pp. 63–84.
- Revel, J., 'Microanalysis and the Construction of the Social', in J. Revel and H. Lynn (eds), *Histories: French Constructions of the Past* (New York: New Press, 1998), pp. 492–502.
- Rodríguez Llopis, M., 'El proceso de formación del término de Lorca en la Baja Edad Media', in F. Chacón Jiménez, J. A. Mula Gómez and F. Calvo García Tornel (eds), *Lorca. Pasado y presente. Aportaciones a la Historia de la Región de Murcia*, vol. I: *La formación de una comarca histórica: Tierras, pueblos y culturas* (Lorca: Ayuntamiento de Lorca-CAM, 1990), pp. 203–11.
- Rodríguez Llopis, M., *Historia de la región de Murcia* (Murcia: Editora Regional, 1998).
- Rodríguez Llopis, M., 'Poder y parentesco en la nobleza santiaguista del siglo XV', *Noticario de Historia Agraria*, 12 (1996), 57–90.
- Rodríguez Llopis, M., *Señoríos y feudalismo en el Reino de Murcia. Los dominios de la Orden de Santiago entre 1440 y 1515* (Murcia: Universidad de Murcia, 1986).

- Rodríguez-Salgado, M., *Un imperio en transición. Carlos V, Felipe II y su mundo* (Barcelona: Crítica, 1992).
- Rodríguez Sánchez, A., 'El poder y la familia. Formas de control y de consanguineidad en la Extremadura de los tiempos modernos', in F. Chacón Jiménez and J. Hernández Franco (eds), *Poder, familia y consanguineidad en la España del Antiguo Régimen* (Barcelona: Anthropos, 1992), pp. 15–34.
- Rucquoi, A., *Valladolid en la Edad Media: la villa del Esgueva* (Valladolid: Fundación Municipal de Cultura, Ayuntamiento, 1983).
- Ruiz, T., *Crisis and Continuity: Land and Town in Late Medieval Castile* (Philadelphia: University of Pennsylvania Press, 1994).
- Ruiz, T., *From Heaven to Earth: The Reordering of Castilian Society, 1150–1350* (Princeton: Princeton University Press, 2004).
- Ruiz, T., *Spain's Centuries of Crisis: 1300–1474* (Malden, MA: Blackwell Publishing, 2007).
- Ruiz García, P., *El Marquesado de Beniel y el mayorazgo de Vélez Málaga* (Murcia: Ayuntamiento de Murcia, 1984).
- Ruiz Ibáñez, J. J., *Las dos caras de Jano. Monarquía, ciudad e individuo. Murcia, 1588–1648* (Murcia: Universidad de Murcia, 1995).
- Ruiz Torres, P., 'Los señoríos valencianos en la crisis del Antiguo Régimen: una revisión historiográfica', *Estudis d'Historia Contemporànea del País Valencià*, 5 (1984), 23–81.
- Ruiz Torres, P., *Señores y propietarios. Cambio social en el Sur del País valenciano: 1650–1850* (Valencia: Institución Alfonso el Magnánimo, 1981).
- Rumeu de Armas, A., *Historia de la previsión social en España* (Barcelona: El Albir, 1981).
- Saavedra Fajardo, D., *Empresas Políticas. Idea de un príncipe político-cristiano*, vol. I, empresa 40 (Qve Tribvnt Tribvit), 1640, Quintín Aldea Baquero (ed.), (1976), pp. 377–93.
- Sánchez de Madariaga, E., 'Cultura religiosa y sociedad: las cofradías de laicos', *Historia Social*, 35 (1999), 23–42.
- Sánchez González, R., 'Las capellanías en el Antiguo Régimen (Siglos XVI–XIX): estudio de la zona de La Sagra', *Anales Toledanos*, 23 (1986), 101–47.
- Sanz Ayán, C., *Los banqueros de Carlos II* (Valladolid: Universidad de Valladolid, 1989).
- Sauvain-Dugerdil, C. and Richard, Ph., 'Le cercle des unions: une définition dynamique de la population ou de la pertinence d'une convergente entre l'antropologie biologique et la démographie historique', in G. Brunet, A. Fauve-Chamoux and M. Oris (eds), *Le choix du conjoint* (Lyon: PPSH, 1998), pp. 27–45.
- Schalk, E., *L'épée et la sang. Une histoire du concept de Noblesse (vers 1500–vers 1600)* (Seysssel: Champ Vallon, 1996).

- Schwartz, S., *All Can Be Saved: Religious Tolerance and Salvation in the Iberian Atlantic World* (New Haven: Yale University Press, 2008).
- Scott, S. P. and Burns, R. I., *Las Siete Partidas*, vol. 1: *The Medieval Church: The World of Clerics and Laymen (Partida I)* (Philadelphia: University of Pennsylvania Press, 2012).
- Segalen, M., 'Mariage et parentèle dans le pays bigouden sud: un exemple de renchéatement d'alliance', in F. Heritier-Auge and E. Copet-Rougier (eds), *Les complexités de l'alliance. Les systèmes complexes d'alliance matrimoniale*, vol. 2 (Paris: Éditions des Archives Contemporaines, 1991), pp. 177–205.
- Shofield, R. S., 'Representativeness and Family Reconstitution', *Annales de Démographie Historique* (1972), 19–24.
- Sicroff, A. A., *Los estatutos de limpieza de sangre. Controversias entre los siglos XV y XVII* (Madrid: Taurus, 1985).
- Sobaler Seco, M. A., 'La articulación de la oligarquía soriana en torno al sistema de linajes: reproducción social y relevos familiares', in A. López Irigoyen and A. L. Pérez Ortiz (eds), *Familia, transmisión y perpetuación (Siglos XVI–XIX)* (Murcia: Universidad de Murcia, 2002), pp. 151–71.
- Sobaler Seco, M. A., "'La Cofradía de nobles caballeros de Santiago" de Soria (1572): un intento frustrado de corporativismo nobiliario', *Investigaciones Históricas*, 12 (1992), 11–29.
- Soria Mesa, E., *El cambio inmóvil. Transformaciones y permanencias en una élite de poder, Córdoba, siglos XVI–XIX* (Córdoba: La Posada, 2000).
- Soria Mesa, E., 'Las capellanías en la Castilla Moderna: familia y ascenso social', in A. Irigoyen López and A. L. Pérez Ortiz (eds), *Familia, transmisión y perpetuación (Siglos XVI–XIX)* (Murcia: Universidad de Murcia, 2002), 135–48.
- Soria Mesa, E., *Señores y oligarcas: los señoríos del Reino de Granada en la Edad Moderna* (Granada: Universidad de Granada, 1997).
- Stone, L., *The Crisis of the Aristocracy, 1558–1641* (New York: Harper and Row, 1979).
- Stone, L., *The Family, Sex and Marriage in England, 1500–1800* (New York: Harper and Row, 1977).
- Suárez Fernández, L., *Historia del Reinado de Juan I de Castilla*, I (Madrid: Estudio, 1977).
- Suárez Fernández, L., *Monarquía Hispana y Revolución Trastámara* (Madrid: Real Academia de la Historia, 1994).
- Tarbin, S. and Broomhall, S. (eds), *Women, Identities and Communities in Early Modern Europe* (Aldershot: Ashgate, 2007).
- Tarrade, J., 'Exogamie et endogamie dans les régions rurales du centre-ouest de la France au XVIIIe siècle', in J. Goyand J. P. Wallot (eds), *Évolution et éclatement du monde rural* (Paris: École de Hautes Études en Sciences Sociales, 1986), pp. 513–32.

- Terpstra, N., *Lay Confraternities and Civic Religion in Renaissance Bologna* (Cambridge: Cambridge University Press, 1995).
- Thompson, I. A. A., 'Cortes y ciudades: tipología de los procuradores (extracción social, representatividad)', in *Las Cortes de Castilla y León en la Edad Moderna* (Valladolid: Junta de Castilla y León, 1989), pp. 191–248.
- Thompson, I. A. A., *Crown and Cortes: Government, Institutions and Representation in Early-Modern Castile* (Norfolk: Variorum, 1993).
- Tilly, C., *Coercion, Capital, and European States AD 990–1990* (Oxford: Basil Blackwell, 1990).
- Tomás y Valiente, F., *Gobierno e instituciones en la España del Antiguo Régimen* (Madrid: Alianza, 1982).
- Torres Fontes, J., 'Conquista y pérdida de Huéscar en el Reinado de Juan II de Castilla', *Murgetana*, 84 (1992), 81–99.
- Torres Fontes, J., *Discurso historial genealógico de la noble familia de los Fontes de Albornoz, naturales de la ciudad y reino de Murcia* (Murcia: Lo Jordán Ediciones-Academia Alfonso X el Sabio, 1990).
- Torres Fontes, J., 'Dualidad fronteriza: guerra y paz', in *Actas del Congreso: La frontera oriental nazarí como sujeto histórico (Siglos XIII–XVI)* (Lorca-Vera: Instituto de Estudios Almerienses, 1994), pp. 63–77.
- Torres Fontes, J., *Fajardo el Bravo* (Murcia: Universidad de Murcia, 1944).
- Torres Fontes, J., 'La conformación de un reino de frontera', in M. Cabrera, R. Menéndez Pidal, S. Juliá Díaz et al. (eds), *Historia de España* (Madrid: Espasa-Calpe, 1990), 13, pp. 431–505.
- Torres Fontes, J., 'Los enemigos del hombre', *Murgetana*, 61 (1981), 99–149.
- Torres Fontes, J., 'Los Fajardo en los siglos XIV y XV', *Miscelánea Medieval*, 4 (1978), 109–72.
- Torres Fontes, J., 'Los fronterizos murcianos en la Edad Media', *Murgetana*, 100 (1999), 11–19.
- Torres Fontes, J., '"Nobiliario de los Fontes" de Alonso Rodríguez Almela', *Murgetana*, 92 (1996), 21–34.
- Torres Fontes, J., 'Relación murciana de los López Ayala en los siglos XIII y XIV', *Murgetana*, 45 (1976), 5–31.
- Torres Fontes, J., *Repartimiento de Lorca* (Murcia: Ayuntamiento de Lorca-Academia Alfonso X el Sabio, 1977).
- Torres Fontes, J., *Repartimiento de Murcia* (Murcia: CSIC-Academia Alfonso X el Sabio, 1960).
- Torres Fontes, J., *Repartimiento de Orihuela* (Murcia: Academia Alfonso X el Sabio-Patronato 'Ángel García Rogel' de la CAM, 1988).
- Torres Fontes, J., *Repartimiento y repoblación de Murcia en el siglo XIII* (Murcia: Academia Alfonso X el Sabio, 1990).
- Torres Fontes, J., *Xiquena, castillo de la frontera* (Murcia: Diputación Provincial, 1960).

- Torres Fontes, J. and Muñoz Barberán, M., *Murcia, reino de fronteras: castillos y torreones de la región* (Alicante: Pedro Olivares Romera, 1988).
- Toubert, P., *Castillos, señores y fortalezas en la Italia medieval* (Barcelona: Crítica, 1990).
- Toubert, P., *Les structures du Latium médiéval. Le Latium méridional et la Sabine du IXe siècle à la fin du XIIe siècle*, 2 (Rome: Bibliothèque des Écoles françaises d'Athènes et de Rome, 1973).
- Truchuelo García, S., *Guipúzcoa y el poder real en la Alta Edad Moderna* (San Sebastián: Diputación Foral de Guipúzcoa, 2004).
- Valdeon Baroque, J., *La dinastía de los Trastámara* (Zaragoza: Ediciones El Viso, 2006).
- Van Zanden, J. L., Baten, J., Foldvari, P., and van Leeuwen, B., 'The changing shape of global inequality 1820–2000: Exploring a new dataset', *Review of Income and Wealth*, 60/2 (2014), 279–97.
- Veas Arteseros, F., 'Dinámica del concejo de Murcia (1420–1440): los regidores', 9 (1982), 87–118.
- Veas Arteseros, F., 'El llamamiento de hidalgos murcianos para la guerra de Portugal', *Miscelánea Medieval Murciana*, 11 (1984), 137–54.
- Veas Arteseros, F., 'Intervención de Lorca en la lucha de Manueles y Fajardos en 1391 y 1395', *Miscelánea Medieval de Murcia*, 7 (1981), 147–56.
- Veas Arteseros, F., 'Lorca, ciudad de frontera', in F. Chacón Jiménez, J. A. Mula Gómez and F. Calvo García Tornel (eds), *Lorca. Pasado y presente. Aportaciones a la Historia de la Región de Murcia*, vol. I: *La formación de una comarca histórica: tierras, pueblos y culturas* (Lorca: Ayuntamiento de Lorca-CAM., 1990), pp. 213–22.
- Velasco Hernández, F., *Auge y estancamiento de un enclave mercantil en la periferia. El nuevo resurgir de Cartagena entre 1540 y 1676* (Murcia: Academia Alfonso X el Sabio-Ayuntamiento de Cartagena, 2001).
- Viazzo, P. P. 'What's So Special About Mediterranean? Thirty Years of Research on Household and Family in Italy', *Continuity and Change*, 18 (2003), 111–37.
- Wasserman, M. L. E., 'Círculos sociales, contextos normativos y crédito. Buenos Aires, siglo XVIII', *América Latina en Historia Económica*, 20/1 (January–April 2013), 35–77.
- William, A. Jr., *Local Religion in Sixteenth Century Spain* (Princeton: Princeton University Press, 1989).
- Windler, C., 'Clientèles royales et clientèles seigneuriales vers la fin de l'Ancien Régime. Un dossier espagnol', *Annales, HSS*, 52 (1997), 293–319.
- Windler, C., 'Gérer des réseaux de relations: intermédiaires "indépendants" et agents de la noblesse seigneuriale', in J. L. Castellano and J. P. Dedieu (eds), *Réseaux, familles et pouvoirs dans le monde ibérique à la fin de l'Ancien Régime* (Paris: CNRS, 1998), pp. 147–68.



- Wolf, E. R., 'Relaciones de parentesco, de amistad y de patronazgo en las sociedades complejas', in M. Banton (ed.), *Antropología de las sociedades complejas* (Madrid: Alianza, 1990), pp. 19–39.
- Yun-Casalilla, B., 'Entre el imperio colonial y la monarquía compuesta. Élités y territorios en la Monarquía Hispánica', in B. Yun-Casalilla (ed.), *Las redes del imperio. Élités sociales en la articulación de la monarquía hispánica 1492–1714* (Madrid: Marcial Pons, 2009), pp. 11–35.
- Yun-Casalilla, B., *Iberian World Empires and the Globalization of Europe, 1415–1668* (London: Palgrave Macmillan, 2019).
- Yun-Casalilla, B., *La gestión del poder. Corona y economías aristocráticas en Castilla, siglos XV–XVIII* (Madrid: Akal, 2002).
- Yun-Casalilla, B., *Marte contra Minerva. El precio del imperio español, c. 1450–1600* (Barcelona: Crítica, 2004).
- Yun-Casalilla, B., *Sobre la transición al capitalismo en Castilla. Economía y sociedad en Tierra de Campos* (Salamanca: Junta de Castilla y León, 1987).
- Yun-Casalilla, B. and Torras, J. (eds), *Consumo, condiciones de vida y comercialización: Cataluña, Castilla, siglos XVII–XIX* (Valladolid: Junta de Castilla y León, 1999).

# Notes

---

## Introduction

- 1 J. Goody, *The Development of the Family and Marriage in Europe* (Cambridge: Cambridge University Press, 1983).
- 2 J. Casey, 'Familia y sociedad' in *El mundo hispánico. Homenaje a John Elliott* (Barcelona: Crítica, 1991), pp. 185–202; J. Casey, *The History of the Family* (Oxford: Basil Blackwell, 1989); J. Casey, *Family and Community in Early Modern Spain: The Citizens of Granada, 1570–1739* (Cambridge: Cambridge University Press, 2007).
- 3 P. Laslett and R. Wall, *Household and Family in Past Time* (Cambridge: Cambridge University Press, 1972); S. A. King, 'Historical demography, life-cycle, reconstruction and family reconstitution: New perspectives', *History and Computing*, 8/2 (1996), 62–77.
- 4 L. F. Costa and M. S. da Cunha, *D. João IV* (Lisbon: Círculo de Leitores, 2006); A. M. Hespanha, *História de Portugal. O Antigo Regime (1620–1807)* (Lisbon: Círculo de Leitores, 1993); T. Herzog, *Frontiers of Possession: Spain and Portugal in Europe and the Americas* (Cambridge, MA: Harvard University Press, 2015).
- 5 C. Ginzburg, *The Cheese and the Worms: The Cosmos of a Sixteenth-Century Miller* (Baltimore: Johns Hopkins University Press, 1992); J. Revel, 'Microanalysis and the Construction of the Social', in J. Revel and H. Lynn (eds), *Histories: French Constructions of the Past* (New York: New Press, 1998), pp. 492–502; D. A. Bell, 'Total History and Microhistory: The French and Italian Paradigms', in L. Kramer and S. Maza (eds), *A Companion to Western Historical Thought* (Oxford: Blackwell, 2006), pp. 262–76; G. Levi, *L'eredità immateriale: carriera di un esorcista nel Piemonte del Seicento* (Turin: Giulio Einaudi, 1985).
- 6 S. Ogilvie, *Institutions and European Trade: Merchant Guilds, 1000–1800* (Cambridge: Cambridge University Press, 2011); L. Stone, *The Crisis of the Aristocracy, 1558–1641* (New York: Harper and Row, 1979); J. B. Owens, *By my Absolute Royal Authority: Justice and the Castilian Commonwealth at the Beginning of the First Global Age* (Rochester, NY:

- University of Rochester Press, 2005); F. Andújar, *El sonido del dinero: monarquía, ejército y venalidad en la España del siglo XVIII* (Madrid: Marcial Pons, 2004).
- 7 D. Reher, *Town and Country in Pre-industrial Spain. Cuenca, 1550–1870* (Cambridge: Cambridge University Press, 1990); Casey, *Family and Community*.
  - 8 H. G. Koenigsberger, *The Habsburgs and Europe, 1516–1660* (Ithaca: Cornell University Press, 1971); H. G. Koenigsberger, *Politicians and Virtuosi: Essays in Early Modern History* (London: Clarendon Press, 1986).
  - 9 F. Chacón Jiménez, 'Presentación: propuestas teóricas y organización social desde la Historia de la familia en la España Moderna', *Studia Histórica*, 18 (1998), 17–26; F. Chacón and J. Bertran (eds), *Familias. Historia de la sociedad española (del final de la Edad Media a nuestros días)* (Barcelona: Crítica, 2011); E. Fernández de Pinedo, *Crecimiento económico y transformaciones sociales del País Vasco* (Madrid: Siglo XXI, 1974).
  - 10 G. Delille, *Le maire et le prieur: pouvoir central et pouvoir local en Méditerranée occidentale, XVe–XVIIIe siècle* (Rome: École française de Rome, 2003); Stone, *The Crisis of the Aristocracy*.
  - 11 L. Stone, *The Family, Sex and Marriage in England, 1500–1800* (New York: Harper and Row, 1977); A. MacFarlane, *Marriage and Love in England, 1300–1840* (Oxford: Blackwell, 1987).
  - 12 M. Perez-Garcia, 'Social Networks and Kinship in Southern Castile: The Clientelistic System in the Kingdom of Murcia (17th–18th Centuries)', *História Unisinos*, 14/3 (2010), 313–29; M. Perez-Garcia, 'New technologies applied to family history: A particular case of Southern Europe in the eighteenth century', *Journal of Family History*, 36/3 (2011), 248–62; M. Gribaudi, 'Réseaux égocentrés et inscriptions sociales: Continuités et discontinuités dans les formes de structuration de l'espace parisien', in M. Gribaudi (ed.), *Espaces Temporalités Stratifications: Exercices sur les réseaux sociaux* (Paris: Éditions de l'École des Hautes Études en Sciences Sociales, 1998), pp. 71–120.
  - 13 C. Tilly, *Coercion, Capital and European States AD 990–1990* (Oxford: Basil Blackwell, 1990); F. Braudel, *El Mediterráneo y el mundo mediterráneo en la época de Felipe II*, vols I–II (Madrid: Fondo de Cultura Económica, 1976).
  - 14 M. E. Casaús, 'La pervivencia de las redes familiares en la configuración de la elite de poder centroamericana. El caso de la familia Durán', *Anuario de Estudios Centroamericanos*, 20/2 (1994), 41–69.
  - 15 J. L. Boone, 'Parental Investment and Elite Family Structure in Preindustrial States: A Case Study of Late Medieval-Early Modern Portuguese Genealogies', *American Anthropologist*, 88 (1986), 859–78;

- M. N. Amorim, 'Demografía Histórica e Família. Uma proposta metodológica', *Studia Historica*, 18 (1998), 29–54; M. Perez-Garcia and L. de Sousa, *Global History and New Polycentric Approaches: Europe, Asia and the Americas in a World Network System*, Palgrave Studies in Comparative Global History (Singapore: Palgrave-Macmillan, 2018); J. L. Van Zanden, J. Baten, P. Foldvari and B. van Leeuwen, 'The changing shape of global inequality 1820–2000: Exploring a new dataset', *Review of Income and Wealth*, 60/2 (2014), 279–97; H. Dong, C. Campbell, S. Kurosu and J. Lee, 'Household context and individual departure: The case of escape in three "Unfree" East Asian Populations, 1700–1900', *Chinese Journal of Sociology* 1/4 (2015), 515–39.
- 16 M. Perez-Garcia, *Vicarious Consumers: Trans-National Meetings between the West and East in the Mediterranean World (1730–1808)* (London: Routledge, 2013).
- 17 Perez-Garcia, *Vicarious Consumers*, pp. 1–19; Perez-Garcia and de Sousa, *Global History and New Polycentric Approaches*, pp. 1–17; H. Dong, C. Campbell, S. Kurosu and J. Lee, 'Household context and individual departure'; D. A. Bell, 'Total History and Microhistory'; T. K. Harenven, 'Historia de la familia y la complejidad del cambio social', *Boletín de la ADEH*, 13/1 (1995), 99–149; F. Chacón Jiménez, 'Notas para una reflexión sobre el estado de la cuestión de la historia de la familia en España', in *Vivir el siglo de Oro. Poder, Cultura e Historia en la época Moderna. Estudios en Homenaje al profesor Ángel Rodríguez Sánchez* (Salamanca: Universidad de Salamanca, 2002), pp. 31–47; G. Muto, 'Famiglia e Storia Sociale', *Studia Histórica*, 18 (1998), 55–66.
- 18 K. Pomeranz, *The Great Divergence: China, Europe, and the Making of the Modern World Economy* (Princeton: Princeton University Press, 2000).
- 19 F. Chacón Jiménez, A. Irigoyen López, E. De Mesquita Samara and T. Lozano Armendares (eds), *Sin distancias. Familia y tendencias historiográficas en el siglo XX* (Murcia: Universidad de Murcia/Universidad Externado de Colombia, 2002).
- 20 D. Cannadine, *The Undivided Past: History Beyond Our Differences* (London: Penguin Books, 2013).

## Chapter 1

- 1 T. Ruiz, *From Heaven to Earth: The Reordering of Castilian Society, 1150–1350* (Princeton: Princeton University Press, 2004); T. Ruiz, *Crisis and Continuity: Land and Town in Late Medieval Castile* (Philadelphia: University of Pennsylvania Press, 1994).
- 2 J. Torres Fontes, *Repartimiento de Murcia* (Murcia: CSIC-Academia Alfonso X el Sabio, 1960).

- 3 J. Torres Fontes, *Repartimiento y repoblación de Murcia en el siglo XIII* (Murcia: Academia Alfonso X el Sabio, 1990).
- 4 Casey, *The History of the Family*; J. Casey and J. Hernández Franco (eds), *Familia, parentesco y linaje* (Murcia: Universidad de Murcia, 1997); I. Beceiro Pita and R. Córdoba de la Llave (eds), *Parentesco, poder y mentalidad. La nobleza castellana siglos XII–XV* (Madrid: CSIC, 1990).
- 5 As Simona Cerutti says, ‘*il suffit parler d’intérêt individuel pour parler d’intérêt groupal*’; S. Cerutti, ‘La construction des catégories sociales’, in J. Boutier and D. Julia (eds), *Passés recomposés: Champs et chantiers de l’histoire* (Paris: Autrement, 1995), pp. 224–349. S. P. Scott and Robert I. Burns, S., *Las Siete Partidas*, vol. 1: *The Medieval Church: The World of Clerics and Laymen (Partida I)* (Philadelphia: University of Pennsylvania Press, 2012).
- 6 F. Chacón Jiménez, ‘Aproximación y notas metodológicas para el estudio de la familia en Castilla durante la Baja Edad Media. Algunos ejemplos murcianos’, in *Homenaje a Juan Torres Fontes* (Murcia: Universidad de Murcia-Academia Alfonso X el Sabio, 1987), pp. 337–48.
- 7 J. Goody, *The Development of the Family*.
- 8 M. V. López Cordón and M. Carbonell Esteller (eds), *Historia de la mujer e Historia del matrimonio* (Murcia: Universidad de Murcia, 1997); C. Kaplisch Zuber, *La famiglia e le donne a Firenze nel Rinascimento* (Bari: Laterza, 1989); A. Rucquoi, *Valladolid en la Edad Media: la villa del Esgueva* (Valladolid: Fundación Municipal de Cultura, 1983).
- 9 B. Yun-Casalilla, *Iberian World Empires and the Globalization of Europe, 1415–1668*, (London: Palgrave Macmillan, 2019), p. 24.
- 10 G. Duby, ‘Estructuras de parentesco y nobleza en la Francia del Norte en los siglos X y XI’, in G. Duby, A. R. Firpo and R. Pastor, *Hombres y estructuras de la Edad Media* (Mexico City: Siglo Veintiuno Editores, 2000), pp.162–83.
- 11 J. Hernández Franco, ‘Consideraciones y propuestas sobre linaje y parentesco’, in J. Casey and J. Hernández Franco (eds), *Familia, parentesco y linaje. Historia de la familia, una nueva perspectiva sobre la sociedad europea* (Murcia: Universidad de Murcia, 1997), pp. 19–29.
- 12 “*Dios fizo homes e no fizo linages*” in the original text; *Crónica de los Reyes Católicos*, (Madrid: Juan de Mata, 1963).
- 13 Torres Fontes, *Repartimiento de Murcia*.
- 14 Archivo Municipal de Jerez (hereafter AMJ), Fondo Soto Molina, *Noticias y antecedentes genealógicos de la familia Riquelme de Murcia* [18th century?], L. 17, E. 306 / M./6 hojas.
- 15 AMJ, Fondo Soto Molina, L. 17, E. 306.
- 16 Archivo Municipal de Murcia (hereafter AMM), Diario de Cartas Reales 1769; sig. 858, fols 19v–22r.

- 17 F. Cascales, *Discursos históricos de la ciudad de Murcia y su Reino* (Murcia: Academia Alfonso X el Sabio, 1980), p. 476.
- 18 Antonio de Varona refers to it in his *vergel* of noblemen, 191, AMM, Diario de Cartas Reales 1769; sig. 858, fols 19v–22r.
- 19 Cascales, *Discursos históricos*, pp. 474–7.
- 20 Cascales, *Discursos históricos*, pp. 474–7.
- 21 AMJ, Fondo Soto Molina; L. 17, E. 306; J. Torres Fontes, *Repartimiento y repoblación*.
- 22 Torres Fontes, *Repartimiento de Murcia*; M. Ll. Martínez Carrillo, 'Reconstrucciones familiares a través de documentos concejiles: los Riquelme murcianos', in V. Montojo y Montojo (ed.), *Linaje, familia y marginación en España (siglos XIII–XIX)* (Murcia: Universidad de Murcia, 1992), pp. 9–37.
- 23 Torres Fontes, *Repartimiento y repoblación*.
- 24 *Cuadrilla* is a unit of land made up of smaller parcels or of villages. See R. Jonathan, *The Sephardic Frontier: The Reconquista and the Jewish Community in Medieval Iberia* (Ithaca and London: Cornell University Press, 2006), p. 182. *Tahulla* is a unit of land area originally used for irrigated farmland in the localities of the kingdom of Murcia. It is typically 1,118 square metres. See T. F. Glick, *Irrigation and Society in Medieval Valencia* (Cambridge, MA: Harvard University Press, 1970); D. Meyerson and D. English, *Christians, Muslims, and Jews in Medieval and Early Modern Spain: Interaction and Cultural Change* (Notre Dame: University of Notre Dame Press, 2000).
- 25 Martínez Carrillo, 'Reconstrucciones familiares,' p. 30.
- 26 AMJ, Fondo Soto Molina; L.17, E. 306.
- 27 Beceiro Pita and Córdoba de la Llave (eds), *Parentesco, poder y mentalidad*.
- 28 S. de Moxó, 'De la vieja nobleza a la nueva. La transformación nobiliaria castellana en la Baja Edad Media', *Cuadernos de Historia, Anexos de la revista Hispania*, 3 (1969), 1–210; M. Pérez-García, 'Al servicio de los Fajardo: familia y patronazgo (siglos XIII–XV)', *Revista Velezana*, 24 (2005), 11–20.
- 29 M. Rodríguez Llopis, *Señoríos y feudalismo en el Reino de Murcia. Los dominios de la Orden de Santiago entre 1440 y 1515* (Murcia: Universidad de Murcia, 1986).
- 30 M. Rodríguez Llopis, *Historia de la Región de Murcia* (Murcia: Editora Regional, 1998).
- 31 Rodríguez Llopis, *Historia de la Región de Murcia*.
- 32 AMM, Diario de Cartas Reales 1769; sig. 858, fols 19v–22r.
- 33 AMJ, Fondo Soto Molina; L. 17, E. 306. To know more about the *procuradores* in the Cortes as representatives of the kingdom at the court of the king, see: I. A. A. Thompson, 'Cortes y ciudades: tipología

- de los procuradores (extracción social, representatividad)', in *Las Cortes de Castilla y León en la Edad Moderna* (Valladolid: Junta de Castilla y León, 1989), pp. 191–248; I. A. A. Thompson, *Crown and Cortes: Government, Institutions and Representation in Early-Modern Castile* (Norfolk: Variorum, 1993).
- 34 M. Rodríguez Llopis, *Historia de la Región de Murcia*; J. Torres Fontes, 'Relación murciana de los López Ayala en los siglos XIII y XIV', *Murgetana*, 45 (1976), 5–31. See by the same author: 'Linaje y poder en el Reino de Murcia (siglos XIII–XV)', in *Actas del III Congreso Hispano-portugués* (Seville, 1997), pp. 901–28.
- 35 R. R. Hill, *The Office of Adelantado* (New York: Ginn & Company, 1913); J. F. O'Callaghan, *Alfonso X, the Justinian of His Age: Law and Justice in Thirteenth-Century Castile* (Ithaca and London: Cornell University Press, 2019); D. J. Dacre Boulton, *The Knights of the Crown: The Monarchical Orders of Knighthood in Later Medieval Europe, 1325–1520* (Woodbridge: Boydell Press, 1987); M. Ll. Martínez Carrillo, *Manuales y Fajardos. La crisis bajomedieval en Murcia* (Murcia, Academia Alfonso X el Sabio, 1985).
- 36 When looking at the concept of feudal ties developed between patron and client, which had deep roots in medieval times and continued to develop during the modern age, it is interesting to highlight the work of A. Maczak, 'From aristocratic household to princely court: Restructuring patronage in the sixteenth and seventeenth centuries', in Ronald G. Asch and Adolf M. Birke (eds), *Princes, Patronage and the Nobility: The Court at the Beginning of the Modern Age* (London: The German Historical Institute, Oxford University Press, 1991); R. Pastor, *Relaciones de poder, de producción y parentesco en la Edad Media y Moderna* (Madrid: Consejo Superior de Investigaciones Científicas, 1990); P. Iradiel, 'Formas de poder y de organización de la sociedad en las ciudades castellanas de la Baja Edad Media', in R. Pastor, I. Kieniewicz, E. García de Enterría et al. (eds), *Estructuras y formas del poder en la Historia* (Salamanca: Ediciones Universidad de Salamanca, 1991), pp. 23–49.
- 37 I. Beceiro Pita, 'La mujer noble en la Baja Edad Media castellana', in Yves-René Fonquerne and Alfonso Esteban (eds), *La condición de la mujer en la Edad Media* (Madrid: Casa de Velázquez, Universidad Complutense, 1986), pp. 289–314.
- 38 B. Reilly, *The Medieval Spain* (Cambridge: Cambridge University Press, 1993); T. Ruiz, *Spain's Centuries of Crisis: 1300–1474* (Malden, MA: Blackwell Publishing, 2007); J. Valdeon Baruque, *La dinastía de los Trastámara* (Zaragoza: Ediciones El Viso, 2006); M. Rodríguez Llopis, *Historia de la Región de Murcia*; L. Suárez Fernández, *Monarquía Hispana y Revolución Trastámara* (Madrid: Real Academia de la Historia, 1994).

- 39 AMJ, Fondo Soto Molina; L. 17, E. 306.
- 40 Suárez Fernández, *Monarquía Hispánica*.
- 41 J. Torres Fontes, 'Los Fajardo en los siglos XIV y XV', *Miscelánea Medieval*, 4 (1978), 109–72.
- 42 J. R. Díaz de Durana (ed.), *La lucha de bandos en el País Vasco: de los Parientes Mayores a la Hidalguía Universal (siglos XIV a XVI)* (Bibao: UPV/EHU, 1998); E. García Fernández (ed.), *Poder en Europa y América, mitos, tópicos y realidades* (Bilbao: UPV/EHU, 2004); A. Dacosta Martínez, *Los linajes de Bizcaya en la Baja Edad Media: poder, parentesco y conflicto* (Bilbao: UPV/EHU, 2004); S. Truchuelo García, *Guipúzcoa y el poder real en la Alta Edad Moderna* (San Sebastián: Diputación Foral de Guipúzcoa, 2004).
- 43 E. Norbert (ed.), *Conocimiento y poder* (Madrid: Las Ediciones de la Piqueta, 1994); K. Rahner (ed.), *Soberanía, poder y violencia* (Madrid: S.M. cop., 1987).
- 44 J. A. Munita Loinaz (ed.), *Conflicto, violencia y criminalidad en Europa y América* (Bilbao: UPV/EHU, 2004).
- 45 J. Torres Fontes, 'Los enemigos del hombre,' *Murgetana*, 61 (1981), 99–149.
- 46 Henry II married the daughter of Don Juan Manuel (who was count of Carrion), Juana Manuel, named *adelantado mayor* of the Kingdom of Murcia to Juan Sanchez Manuel. J. Torres Fontes, 'Los enemigos del hombre'.
- 47 AMJ, Fondo Soto Molina; L. 17, E. 306; AMM, Diario de Cartas Reales 1769; sig. 858, fols 19v–22r; AMM, Acta Capitular Era 1409; fol. 61 (8-11-1371), in Martínez Carrillo, *Manueles y Fajardos*.
- 48 AMM, Diario de Cartas Reales 1769; sig. 858, fols 19v–22r.
- 49 AMM, Act. Cap. Era 1413; fol. 111r (27-1-1375), in Martínez Carrillo, *Manueles y Fajardos*.
- 50 Rodríguez Llopis, *Historia de la Región de Murcia*.
- 51 AMM, Act. Cap. 1392; fol. 67r and ss. (11-8-1392); AMM, Act. Cap. 1392; fol. 67r and ss. (11-8-1392) and 142 (13-11-1392).
- 52 AMM, Libro del Clavario de 1391–1392; M. Ll. Martínez Carrillo, 'El padrón de cuantiosos murcianos de 1374', *Miscelánea Medieval Murciana*, 11 (1984), 239–60.
- 53 M. Rodríguez Llopis, *Historia de la Región de Murcia*.
- 54 Archivo Municipal de Lorca (hereafter AML), 1391-IX-10, Carpeta de borradores, sin numerar; F. Veas Arteseros, 'Intervención de Lorca en la lucha de Manueles y Fajardos en 1391 y 1395', *Miscelánea Medieval de Murcia*, 7 (1981), 152.
- 55 AMJ, Fondo Soto Molina; L. 17, E. 306. In the *Manuscrito Riquelme* the aforesaid wife to Pedro Gómez Dávalos, niece to the *adelantado mayor* Alonso Yañez Fajardo, appears under the name of Isabel and not



- Guisabel, as it is mentioned in the article written by Martínez Carrillo, 'Reconstrucciones familiares'; Pastor, *Relaciones de poder*; L. Accati Levi, 'Il matrimonio fra lo stato e la chiesa, la sposa fra marito e figlio', in M. V. López Cordón and M. Carbonell Esteller (eds), *Historia de la mujer e Historia del matrimonio* (Murcia: Universidad de Murcia, 1997), pp. 35–44; C. Brooke, *The Medieval Idea of Marriage* (Oxford: Clarendon Press, 1989); A. Maczak, 'From aristocratic household'; A. Maczak, *Klientelsysteme in Europa der frühen Neuzeit*, Schriften des Historischen Kollegs, Kolloquien 9 (Munich: De Gruyter Oldenbourg, 1988). J. R. Major, "'Bastard Feudalism" and the kiss: Changing social mores in late medieval and early modern France', *Journal of Interdisciplinary History*, 27 (1987), 509–35.
- 56 F. Veas Arteseros, 'Intervención de Lorca'; J. Hernández Franco and J. F. Jiménez Alcázar, 'Estado, aristocracia y oligarquías urbanas en el Reino de Murcia. Un punto de flexión en torno a las comunidades de Castilla', *Chronica Nova*, 23 (1996), 171–87.
- 57 AMJ, Fondo Soto Molina; L. 17, E. 306.
- 58 AMJ, Fondo Soto Molina; L. 17, E. 306; F. Veas Arteseros, 'Intervención de Lorca'; AMM, Diario de Cartas Reales 1769; sig. 858, fols 19v–22r; AMM, Act. Cap. 1443; fols 156r (12-12-1443) and 71 (8-2-1444); Martínez Carrillo, 'Reconstrucciones familiares'.
- 59 AMM, Diario de Cartas Reales 1769; sig. 858, 1769, fols 19v–22r.
- 60 P. Anderson, *Lineages of the Absolutist State* (London: NLB, 1974); J. H. Elliott, *España y su mundo 1500–1700* (Madrid: Alianza Editorial, 1990); L. Bourquin, *Noblesse seconde et pouvoir en Champagne aux XVIe. et XVIIe. siècles* (Paris: Publications de la Sorbonne, 1994); B. Yun-Casalilla, 'Entre el imperio colonial y la monarquía compuesta. Élités y territorios en la Monarquía Hispánica', in B. Yun-Casalilla (ed.), *Las redes del imperio. Élités sociales en la articulación de la Monarquía Hispánica 1492–1714* (Madrid: Marcial Pons, 2009), pp. 11–35; A. R. Disney, *A History of Portugal and the Portuguese Empire* (Cambridge: Cambridge University Press, 2009); A. Dacosta Martínez, 'Ser hidalgo en la Vizcaya bajomedieval. Fundamentos de un imaginario colectivo', in I. Reguera and R. Porres (eds), *Poder, pensamiento y cultura en el Antiguo Régimen*. Actas de la 1ª semana de Estudios Históricos de 'Noble Villa de Portugalete' (San Sebastián: Eusko Ikaskuntza, 2002), pp. 15–32; J. R. Díaz de Durana, *La otra nobleza, escuderos e hidalgos sin nombre y sin historia: hidalgos e hidalguía universal en el País Vasco al final de la Edad Media (1250–1525)* (Bilbao: UPV/EHU, 2004).
- 61 T. Herzog, *Frontiers of Possession*; A. Bazzana, 'El concepto de frontera en el Mediterráneo occidental en la Edad Media', *Actas del Congreso: La frontera oriental nazarí como sujeto histórico (siglos XIII–XVI)* (Lorca-Vera: Instituto de Estudios Almerienses, 1994), pp. 25–46.

- 62 J. R. Díaz de Durana and I. Reguera (eds), *Lope García de Salazar: banderizo y cronista*. Actas de las II Jornadas de Estudios Históricos 'Noble Villa de Portugalete' (Portugalete: Ayuntamiento de Portugalete, 2002); J. Torres Fontes, 'Dualidad fronteriza: guerra y paz', *Actas del Congreso: La frontera oriental nazarí como sujeto histórico (siglos XIII–XVI)* (Lorca-Vera: Instituto de Estudios Almerienses, 1994), 63–77.
- 63 J. F. Jiménez Alcázar, 'Territorio y frontera en el Reino de Murcia durante la Baja Edad Media', *Yakka*, 5 (1994), 25–9.
- 64 A. Carmona González, 'La frontera: doctrina islámica e instituciones nazaríes', *Actas del Congreso: La frontera oriental nazarí como sujeto histórico (siglos XIII–XVI)* (Lorca-Vera: Instituto de Estudios Almerienses, 1994), pp. 47–57; R. Pastor, *Del Islam al Cristianismo: en las fronteras de dos formaciones económico sociales: Toledo, siglos XI–XIII* (Barcelona: Península, 1975).
- 65 S. de Dios, *Gracia, merced y patronazgo real: la Cámara de Castilla entre 1474 y 1530* (Madrid: Centro de Estudios Constitucionales, 1982).
- 66 M. Perez-García, 'Servicios en la frontera: el apogeo del linaje de los Riquelme (siglos XIII–XVI)', *Actas del Congreso-Homenaje a José Rodríguez Molina: Iglesias y Fronteras* (Alcalá la Real: Ayuntamiento de Alcalá la Real, 2004), pp. 613–20.
- 67 I. García Díaz, 'La política caballeresca de Alfonso XI', *Miscelánea Medieval*, 11 (1984), 119–33.
- 68 D. Catalán (ed.), *Gran Crónica de Alfonso XI*, vol. 1 (Madrid: Seminario Menéndez Pidal, Universidad Complutense de Madrid, 1976).
- 69 R. Baeza, *Poema del Cid* (Buenos Aires: Editorial Atlántida S.A., 1952).
- 70 G. Duby, 'La diffusion du titre chevaleresque sur le versant méditerranéen de la Chrétienté latine', in P. Contamine (ed.), *La noblesse au Moyen Âge (XIe–XVe siècles)* (Paris: Presses Universitaires de France, 1976), pp. 39–70.
- 71 F. Veas Arteseros, 'Lorca, ciudad de frontera', in F. Chacón Jiménez, J. A. Mula Gómez and F. Calvo García Tornel (eds), *Lorca. Pasado y presente. Aportaciones a la Historia de la Región de Murcia*, vol. I: *La formación de una comarca histórica: tierras, pueblos y culturas* (Lorca: Ayuntamiento de Lorca-CAM., 1990), pp. 213–22.
- 72 García Díaz, 'La política caballeresca'.
- 73 De Moxó, 'De la vieja nobleza'; Beceiro Pita and Córdoba de la Llave, *Parentesco, poder y mentalidad*; M. A. Ladero Quesada, 'Corona y ciudades en la Castilla del siglo XV', *España Medieval*, 5 (1986), 551–74; M. A. Ladero Quesada, 'Linajes, bandos y parcialidades en la vida política de las ciudades castellanas (siglos XIV y XV)', in *Actas Coloquio celebrado en la Biblioteca Española de París* (1987) (Madrid: Ministerio de Asuntos Exteriores, 1991), pp. 105–34; M. Diago

- Hernando, 'Estructuras familiares de la nobleza urbana en la Castilla bajomedieval: los doce linajes de Soria', *Studia Stórica-Historia Medieval*, 10 (1992), 47–71; M. C. Gerbet, *La nobleza en la Corona de Castilla. Sus estructuras sociales en Extremadura (1454–1516)* (Cáceres: Diputación Provincial de Cáceres, Institución Cultural El Brocense, 1989).
- 74 J. F. Jiménez Alcázar, *Un concejo de Castilla en la frontera de Granada: Lorca 1460–1521* (Granada: Universidad de Granada, 1997).
- 75 Jiménez Alcázar, *Un concejo de Castilla*.
- 76 M. A. Sobaler Seco, 'La articulación de la oligarquía soriana en torno al sistema de linajes: reproducción social y relevos familiares', in A. López Irigoyen and A. L. Pérez Ortiz (eds), *Familia, transmisión y perpetuación (siglos XVI–XIX)* (Murcia: Universidad de Murcia, 2002), pp. 151–71; J. A. Lema, J. A. Fernández de Larrea, E. García, M. Larrañaga, J. A. Munita and J. R. Díaz de Durana, *El triunfo de las élites urbanas guipuzcoanas: nuevos textos para el estudio del gobierno de nuevas villas y de la provincia (1412–1539)* (Donostia-San Sebastián: Diputación Foral de Guipúzcoa, 2002), p. 111.
- 77 Martínez Carrillo, 'El padrón de cuantiosos murcianos'; A. L. Molina Molina, 'Aportación para un estudio económico de Enrique II: Murcia', *Miscelánea Medieval Murciana*, 2 (1976), 169–226.
- 78 A. R. Disney, *A History of Portugal*; L. Suárez Fernández, *Historia del Reinado de Juan I de Castilla*, I (Madrid: Estudio, 1977).
- 79 AMM, Act. Cap., 1384; fols 17r–18r; F. Veas Arteseros, 'El llamamiento de hidalgos murcianos para la guerra de Portugal', *Miscelánea Medieval Murciana*, 11 (1984), 137–54.
- 80 Cascales, *Discursos históricos*, pp. 191–2.
- 81 J. Pérez, 'Réflexions sur l'hidalguia', in J. Pérez (ed.), *De l'humanisme aux Lumières. Études sur l'Espagne et l'Amérique* (Madrid: Casa de Velázquez, 2000), pp. 139–48.
- 82 AMJ, Fondo Soto Molina; L. 17, E. 306; AMM, Diario de Cartas Reales 1769; sig. 858, fols 19r–22v.
- 83 AMJ, Fondo Soto Molina; L. 17, E. 306.
- 84 Torres Fontes, 'Los Fajardo'.
- 85 J. Torres Fontes, 'Los fronterizos murcianos en la Edad Media', *Murgetana*, 100 (1999), 11–19; J. Torres Fontes and M. Muñoz Barberán, *Murcia, reino de fronteras: castillos y torreones de la región* (Alicante: Pedro Olivares Romera, 1988); J. Torres Fontes, 'La conformación de un reino de frontera', in M. Cabrera, R. Méndez Pidal, S. Juliá Díaz et al. (eds), *Historia de España* (Madrid: Espasa-Calpe, 1990), 13, pp. 431–505.
- 86 Rodríguez Llopis, *Historia de la Región de Murcia*.

- 87 Jiménez Alcázar, *Un concejo de Castilla*; M. Rodríguez Llopis, 'El proceso de formación del término de Lorca en la Baja Edad Media', in F. Chacón Jiménez, J. A. Mula Gómez and F. Calvo García Tornel (eds), *Lorca. Pasado y presente. Aportaciones a la Historia de la Región de Murcia*, vol. I: *La formación de una comarca Histórica: tierras, pueblos y culturas* (Lorca: Ayuntamiento de Lorca-CAM, 1990), pp. 203–11.
- 88 P. Toubert, *Les structures du Latium médiéval. Le Latium méridional et la Sabine du IXe siècle à la fin du XIIe siècle*, 2 (Rome: Bibliothèque des Écoles françaises d'Athènes et de Rome, 1973); P. Toubert, *Castillos, señores y fortalezas en la Italia medieval* (Barcelona: Crítica, 1990); P. Guichard, *Al-Andalus frente a la conquista cristiana. Los musulmanes de Valencia (siglos XI–XIII)* (Valencia: Biblioteca Nueva, Universidad de Valencia, 2001).
- 89 J. Torres Fontes, 'Conquista y pérdida de Huéscar en el Reinado de Juan II de Castilla', *Murgetana*, 84 (1992), 81–99.
- 90 J. Torres Fontes, *Xiquena, castillo de la frontera* (Murcia: Diputación Provincial, 1960).
- 91 Rodríguez Llopis, *Historia de la Región de Murcia*.
- 92 AMJ, Fondo Soto Molina; L. 17, E. 306.
- 93 J. Cerdá, 'Adelantados Mayores y concejo de Murcia', *Estudios jurídico-medievales de Murcia y de su reino* (1987), 121–67.
- 94 J. Contreras, *Sotos contra Riquelmes: regidores, inquisidores y criptojudíos* (Madrid: Anaya & Mario Muchnik, 1992).
- 95 AMJ, Fondo Soto Molina; L. 17, E. 306.
- 96 AMJ, Fondo Soto Molina; L. 17, E. 306.
- 97 AMJ, Fondo Soto Molina; L. 17, E. 306.
- 98 AMJ, Fondo Soto Molina; L. 17, E. 306; Archivo Real Chancillería de Granada (hereafter ARCG), Cabina 402, Legajo 3360, Pieza 24.
- 99 J. Pérez, *Isabel y Fernando. Los Reyes Católicos* (Madrid: Nerea, 1988).
- 100 AMJ, Fondo Soto Molina; L. 17, E. 306.
- 101 AMJ, Fondo Soto Molina; L. 17, E. 306.
- 102 Pérez, *Isabel y Fernando*.
- 103 G. Lemeunier, 'Propiedad y economía agraria en Lorca (siglos XVI–XVIII)', in F. Chacón Jiménez, J. A. Mula Gómez and F. Calvo García Tornel (eds), *Lorca. Pasado y Presente. Aportaciones a la Historia de la Región de Murcia*, vol. I: *La formación de una comarca histórica: tierras, pueblos y culturas* (Lorca: Ayuntamiento de Lorca-CAM, 1990), pp. 275–83; J. Torres Fontes, *Repartimiento de Lorca* (Murcia: Ayuntamiento de Lorca-Academia Alfonso X el Sabio, 1977).
- 104 Rodríguez Llopis, *Historia de la Región de Murcia*; Jiménez Alcázar, *Un concejo de Castilla*; Rodríguez Llopis, *Señoríos y feudalismo*.
- 105 AMJ, Fondo Soto Molina; L. 17, E. 306; A. Merino Álvarez, *Geografía histórica del territorio de la actual provincia de Murcia: desde la reconquista*

- por Jaime I de Aragón hasta el presente (Murcia: Academia Alfonso X el Sabio, 1978), p. 205.
- 106 Ma. T. Pérez Picazo, *El mayorazgo en la historia económica de la región murciana, expansión, crisis y abolición (siglos XVII–XIX)* (Madrid: Ministerio de Agricultura, Pesca y Alimentación, 1990); Archivo Histórico Provincial de Murcia (hereafter AHPM), Sig. 4961, Inventario y partición de bienes de Antonio Riquelme, escr. Deogracias Serrano, 1839.
- 107 G. Lemeunier, *Los señoríos murcianos (siglos XVI–XVIII)* (Murcia: Universidad de Murcia, 1998).
- 108 I. Atienza Hernández, 'La construcción de lo real. Genealogía, casa, linaje y ciudad: una determinada relación de parentesco', in J. Casey and J. Hernández Franco (eds), *Familia, parentesco y linaje. Historia de la familia, una nueva perspectiva sobre la sociedad europea* (Murcia: Universidad de Murcia, 1997), pp. 41–59.
- 109 M. Muñoz Clarés, 'El encargo de pintura en Lorca: los ciclos heroicos municipales', in F. Chacón Jiménez, J. Mula Gómez and F. Calvo García Tornel (eds), *Lorca. Pasado y Presente. Aportaciones a la Historia de la Región de Murcia*, vol. I: *La formación de una comarca histórica. Tierras, pueblos y culturas* (Lorca: Ayuntamiento de Lorca-CAM, 1990), pp. 93–106; AMJ, Fondo Soto Molina; L. 17, E. 306; AMM, Diario de Cartas Reales; sig., 858, 1769, fols 19r–22v.
- 110 A. Peñafiel Ramón and Hernández Franco, 'Parentesco, linaje y mayorazgo en una ciudad mediterránea Murcia (siglos XV–XVIII)', *Hispania*, 58/198 (1998), 157–83.
- 111 J. H. Elliott, *La España Imperial (1469–1716)* (Barcelona: Vicens Vives, 1998).
- 112 J. Caro Baroja, *Los moriscos del Reino de Granada* (Madrid: Instituto de Estudios Políticos, 1957), p. 7.
- 113 B. Clavero, *Mayorazgo. Propiedad feudal en Castilla (1369–1836)* (Madrid: Siglo XXI, 1974).
- 114 Elliott, *La España Imperial*.
- 115 AMJ, Fondo Soto Molina; L. 17, E. 306; Archivo Histórico Nacional (hereafter AHN), Sección Consejos; Leg. 4953.
- 116 B. Yun, *Marte contra Minerva. El precio del imperio español, c. 1450–1600* (Barcelona: Crítica, 2004).
- 117 Pérez, *Isabel y Fernando*.
- 118 R. Molina Recio, *Los señores de la Casa del Bailío. La élite local castellana (Córdoba, siglos XV–XIX)* (Córdoba: Diputación de Córdoba, 2002).
- 119 Elliott, *La España Imperial*.
- 120 Mattingly, *Renaissance Diplomacy*, pp. 64–70, 145–52.
- 121 ARCG, Cabina 402, Leg. 3406, Pieza 17; AMJ, Fondo Soto Molina; L.17, E. 306.

- 122 AMJ, Fondo Soto Molina; L. 17, E. 306.
- 123 AMJ, Fondo Soto Molina; L. 17, E. 306: *Noticias y antecedentes genealógicos de la familia Riquelme de Murcia*, 6 hojas; AMM, Cartas Reales 1769; sig. 858, 1769, fols 19v–22r; ARCG, Cabina 402, Leg. 3406, Pieza 17.
- 124 AMJ, Fondo Soto Molina; L.17, E. 306; AMM, Diario de Cartas Reales 1769; sig. 858, fols 19v–22r; J. B. Owens, ‘Los regidores y jurados de Murcia: 1500–1650: una guía’, *Anales de la Universidad de Murcia*, 38/3 (1979–80), 95–150.

## Chapter 2

- 1 J. B. Owens, *Rebelión, monarquía y oligarquía murciana en la época de Carlos V* (Murcia: Universidad de Murcia, 1980); S. Haliczzer, *The Comuneros of Castile: The Forging of a Revolution, 1475–1521* (Madison: The University of Wisconsin Press, 1981); J. Pérez, *Los comuneros* (Madrid: La Esfera de los Libros, 2001); A. Espinosa, *The Empire of the Cities: Emperor Charles V, the Comunero Revolt, and the Transformation of the Spanish System* (Leiden: Brill, 2009).
- 2 H. R. Po-Chia, *The World of Catholic Renewal, 1540–1770* (Cambridge: Cambridge University Press, 1998).
- 3 J. I. Israel, *The Dutch Republic: Its Rise, Greatness, and Fall 1477–1806* (Oxford: Clarendon Press, 1995); J. I. Israel, *The European Jewry in the Age of Mercantilism* (Oxford: Clarendon Press, 1985).
- 4 H. Kamen, *Spain, 1469–1714: A Society of Conflict* (London: Routledge, 2014); K. Lynn, *Between Court and Confessional: The Politics of Spanish Inquisitors* (New York: Cambridge University Press, 2013); S. Schwartz, *All Can Be Saved: Religious Tolerance and Salvation in the Iberian Atlantic World* (New Haven: Yale University Press, 2008); M. P. Holt, *The French Wars of Religion, 1562–1629* (Cambridge: Cambridge University Press, 1995); G. Parker, *Spain and The Netherlands, 1559–1659* (London: Collins, 1979).
- 5 E. Buttigieg, *Nobility, Faith and Masculinity: The Hospitaller Knights of Malta, c.1580–c.1700* (London: Bloomsbury, 2011).
- 6 A. William Jr., *Local Religion in Sixteenth-Century Spain* (Princeton: Princeton University Press, 1989); J. Pérez Villanueva and B. Escandell Bonet (eds), *Historia de la Inquisición en España y América* (Madrid: Centro de Estudios Inquisitoriales, 1984), pp. 226–71; A. Devyer, *Le sang épuré. Les préjugés de race chez les gentilhommes français de l’Ancien Régime (1560–1720)* (Brussels: Éditions de l’Université de Bruxelles, 1973); A. Jouanna, *Ordre social. Mythes et hiérarchies dans la France du XVI<sup>e</sup> siècle* (Paris: Hachette, 1977) ; A. Jouanna, ‘De “gross et grass” aux “gens d’honneur”’ in G. Chaussinaud-Nogaret (ed.), *Histoire des élites en France du XVI<sup>e</sup> au XX<sup>e</sup> siècle* (Paris: Tallandier, 1991), pp. 15–141.

- 7 L. de Sousa, *The Jewish Diaspora and the Pérez Family Case in China, Japan, the Philippines, and the Americas (16th Century)* (Macau: Fundação Macau, 2015); L. de Sousa, *The Portuguese Slave Trade in Early Modern Japan: Merchants, Jesuits and Japanese, Chinese, and Korean Slaves* (Leiden: Brill, 2018).
- 8 J. Contreras, 'Estructuras familiares y linajes en el mundo judeoconverso', in R. Carrasco (ed.), *Solidarités et sociabilités en Espagne (XVIe–XXe siècles)* (Paris: Annales Littéraires de l'Université de Besançon, 1991), pp. 187–241.
- 9 J. P. Dedieu, '¿Pecado original o pecado social? Reflexiones en torno a la constitución y a la definición del grupo judeoconverso en Castilla', *Manuscrits*, 10 (1992), 61–76.
- 10 J. Hernández Franco, 'El pecado de los padres: construcción de la identidad conversa en Castilla a partir de los discursos sobre limpieza de sangre', *Hispania*, 64/217 (2004), 515–42.
- 11 Contreras, *Sotos contra Riquelmes*.
- 12 J. Blázquez Miguel, 'Catálogo de los procesos inquisitoriales del Tribunal del Santo Oficio de Murcia', *Murgetana*, 74 (1987), 7–109.
- 13 J. Contreras, 'Linajes y cambio social: la manipulación de la memoria', *Historia Social*, 21 (1995), 105–24; J. M. García Marín, *El oficio público en Castilla durante la Baja Edad Media* (Madrid: Instituto Nacional Administración Pública, 1987).
- 14 P. Bourdieu, *Le sens pratique* (Paris: Les Éditions de Minuit, 1980).
- 15 J. A. Maravall, *Poder, honor y elites en el siglo XVII* (Madrid: Siglo XXI, 1984).
- 16 F. J. Guillamón Álvarez, *Honor y honra en la España del siglo XVIII* (Madrid: Universidad Complutense, 1981).
- 17 Cascales, *Discursos históricos*; J. Torres Fontes, *Discurso historial genealógico de la noble familia de los Fontes de Albornoz, naturales de la ciudad y reino de Murcia* (Murcia: Lo Jordán Ediciones-Academia Alfonso X el Sabio, 1990).
- 18 Peñafiel Ramón and Hernández Franco, 'Parentesco, linaje y mayorazgo'.
- 19 J. Contreras, 'Criptojudasismo en la España Moderna: clientelismo y linaje', *Áreas*, 9 (1988), 77–100.
- 20 Torres Fontes, *Los Fajardo*; M. Rodríguez Llopis, 'Poder y parentesco en la nobleza santiaguista del siglo XV', *Noticario de Historia Agraria*, 12 (1996), 57–90.
- 21 B. Yun, *Marte contra Minerva* (Barcelona: Crítica, 2004).
- 22 J. Torres Fontes, *Fajardo el Bravo* (Murcia: Universidad de Murcia, 1944).
- 23 G. Lemeunier, 'Des gens belliqueux et a l'âme altièrre. Sur les bandos murciens de l'époque moderne', in R. Carrasco (ed.), *Solidarités et*

- socialibilités en Espagne (XVIe–XXe siècles)* (Paris: Annales Littéraires de l'Université de Besançon, 1991), pp. 277–96.
- 24 M. Perez-Garcia, 'Familia, poder y linaje. Conformación de bandos y surgimiento de luchas en torno a la oligarquía murciana (siglos XV–XVI)', in *VI Congreso Internacional. Las Fronteras. Población y doblamiento. Congreso-Homenaje a Manuel González Jiménez* (Alcalá la Real: Ayuntamiento de Alcalá la Real, 2005).
  - 25 Cl. H. Breteau, and N. Zagnoli, 'Le système de gestion de la violence dans deux communautés rurales méditerranéennes: la Calabre méridionale et le N.E. Constantinois', in R. Verdier (ed.), *La vengeance dans les sociétés extra-occidentales* (Paris: Cujas, 1980), pp. 43–73.
  - 26 M. Benaiteau, 'Una nobilità di lunga durata: strategie e comportamenti dei Tocco di Montemiletto', in María A. Visceglia (ed.), *Signori, patrizi, cavalieri nell'età moderna*, Biblioteca di Cultura Moderna (Bari: Laterza, 1992), pp. 193–213; G. Delille, 'Storia politica e antropología: gruppi di potere locale nel Mediterraneo occidentale dal XVe al XVII secolo', *L'Uomo*, 7/1–2 (1994), 132–55.
  - 27 I. Leverenz, 'Società segmentaria', in B. Streck (ed.), *Dizionario di etnologia* (Milan: Sugarco Edizioni, 1987), pp. 232–4.
  - 28 O. Raggio, *Faide e parentele. Lo stato genovese visto dalla Fontanabuona*, Microstorie, 18 (Turin: Einaudi, 1990).
  - 29 G. Lemeunier and J. Gonzalez Castaño, 'Señores y oligarcas. Las luchas políticas en Mula durante los siglos XVI y XVII', *Áreas*, 10 (1989), 119–44.
  - 30 J. Pérez, *La revolución de las comunidades de Castilla (1520–1521)* (Madrid: Siglo XXI, 1970).
  - 31 J. B. Owens, 'Situación social poder político en Murcia, 1490–1570', *Historia de la Región de Murcia*, 5 (1980), pp. 22–34.
  - 32 AHN, Sección Ordenes Militares, Santiago; E. 2072.
  - 33 AHN, Secc. OOMM Santiago; E. 3124.
  - 34 AMJ, Fondo Soto in Molina, Noticias y antecedentes genealógicos de la familia Riquelme de Murcia; eighteenth century, L. 17, E. 306, M./6 hojas; Owens, *Rebelión, monarquía y oligarquía*.
  - 35 Archivo Municipal de Murcia (hereafter AMM), Acta Capitular; 14-7-1509.
  - 36 F. Chacón Jiménez, 'Las comunidades un conflicto de intereses', *Historia de la Región de Murcia*, 5 (1980), 15–21; F. Chacón Jiménez, 'Viejos problemas nuevas situaciones', *Historia de la Región de Murcia*, 5 (1980), 2–14.
  - 37 J. B. Owens, 'La oligarquía murciana en la defensa de su posición: 1570–1650', *Historia de la Región de Murcia*, 6 (1980), 236–61.
  - 38 Owens, *Rebelión, monarquía y oligarquía*.
  - 39 Owens, *Rebelión, monarquía y oligarquía*.



- 40 P. Catedra, 'Fray Vicente Ferrer y la predicación antijudaica en la campaña castellana 1411-12', in *Qu'un sang impur. . . converses et le pouvoir en l'Espagne à la fin du moyen âge*, in Actes du deuxième colloque d'Aix-en-Provence, 18, 19 and 20 November 1994 (Marseille: Université de Provence, 1997), p. 34; Pérez, *Isabel y Fernando*, 1988.
- 41 J. I. Gutiérrez Nieto, 'La estructura castizo-estamental de la sociedad castellana del siglo XVI', *Hispania*, 125 (1973), 519-63.
- 42 J. Caro Baroja, *Los judíos en la España Moderna y Contemporánea*, vol. 1 (Madrid: Istmo, 2000).
- 43 L. Cachón, *¿Movilidad social o trayectoria de clase?* (Madrid: Siglo XXI, 1989), p. 534.
- 44 J. Hernández Franco, 'Trayectoria social de una familia conversa: los Santesteva-Lara. Del empinamiento a la condena', in *Disidencias y exilios en la España Moderna* (Alicante: Publicaciones de la Universidad de Alicante-AHME, 1997), pp. 179-92.
- 45 A. Domínguez Ortiz, *Los judeoconversos en la España Moderna* (Madrid: Editorial MAPFRE, 1992). Also see A. Domínguez Ortiz, *Las clases privilegiadas en el Antiguo Régimen* (Madrid: Istmo, 1973).
- 46 J. Hernández Franco, *Cultura y limpieza de sangre en la España Moderna. Puritate sanguinis* (Murcia: Universidad de Murcia, 1996).
- 47 L. Martz, 'Pure blood statutes in Sixteenth-Century Toledo: Implementation as opposed to adoption', *Sepharad*, 54/1 (1994), 83-108.
- 48 J. Contreras, 'Limpieza de sangre: los discursos de la retórica y la importancia de las realidades', in E. Belenguer Cebriá (ed.), *Felipe II y el Mediterráneo*, vol. 2 (Madrid: Sociedad Estatal para la Conmemoración de los Centenarios de Felipe II y Carlos V, 1999), pp. 481-501.
- 49 A. A. Sicroff, *Los estatutos de limpieza de sangre. Controversias entre los siglos XV y XVII* (Madrid: Taurus, 1985).
- 50 Fray Agustín Salucio, *Discurso acerca de la injusticia y buen gobierno de España, en los estatutos de limpieza de sangre, y si conviene, o no, alguna limitación en ellos*, s.d. (Cieza: A. Pérez Gómez, 1975), fol. 1r. See also M. Perez-Garcia, 'El pensamiento europeo sobre la revisión y moderación en los estatutos de limpieza de sangre a través de la razón de estado cristiana en tiempos de Felipe IV', *Bulletin for Spanish and Portuguese Historical Studies*, 38/1 (2013), 39-60.
- 51 Sicroff, *Los estatutos de limpieza de sangre*.
- 52 J. Hernández Franco and J. J. Ruíz Ibáñez, 'Conflictividad social en torno a la limpieza de sangre en la España Moderna', *Investigaciones Históricas*, 23 (2003), 35-56.
- 53 A. Jouanna, *Ordre social*; E. Schalk, *L'épée et le sang. Une histoire du concept de Noblesse (vers 1500-vers 1600)* (Seysssel: Champ Vallon, 1996);

- G. Chaussinand-Nogaret, *Histoire des élites en France, du XVIe au XXe siècle: l'honneur, le mérite, l'argent* (Paris: Tallandier, 1991), pp. 118–40.
- 54 B. Bennassar, 'Vivre à Andujar au XVIIe siècle', in *Actas del I Congreso de Historia de Andalucía Moderna siglos XVI–XVII*, 1 (1978), pp. 131–41.
- 55 Contreras, *Sotos contra Riquelmes*.
- 56 AHN, Sección Inquisición, Carta del Tribunal al Consejo del 17 de abril de 1551; L. 2023, E. 18.
- 57 J. Heers, *Le clan familial au Moyen Âge* (Paris: P.U.F., 1974); J. Heers, *Les partis et la vie politique dans l'Occident médiéval* (Paris: P.U.F., 1981); J. Heers, *Hommage à Roland Mousnier, Clientèles et fidélités en Europa à l'époque moderne* (Paris: P.U.F., 1981).
- 58 Contreras, *Sotos contra Riquelmes*.
- 59 Contreras, *Sotos contra Riquelmes*.
- 60 J. A. Maravall, *La cultura del Barroco* (Barcelona: Ariel, 1986).
- 61 Archivo Histórico Provincial de Murcia (hereafter AHPM), Martín Faura; 15-4-1544, sig. 617, fol. 909.
- 62 AHPM, Juan Rodríguez de Castro; 30-10-1610, sig. 1966, fol. 864; AHPM, Salvador Fernández; 24-10-1596, sig. 206, fol. 896
- 63 AHPM, Martín Faura; 15-4-1544, sig. 617, fol. 909.
- 64 H. Kamen, *The Spanish Inquisition: A Historical Revision* (New Haven and London: Yale University Press, 2014); J. Pérez, *Breve Historia de la Inquisición en España* (Barcelona: Crítica, 2012); L. R. Corteguera, *Death by Effigy: A Case from the Mexican Inquisition* (Philadelphia: University of Pennsylvania Press, 2012); AHN, Secc. Inq.; L. 2797; AHN, Secc. Inq.; L. 2796.
- 65 AHPM, Pedro López; 2-2-1538, sig. 363, fol. 643.
- 66 Contreras, *Sotos contra Riquelmes*.
- 67 AHN, Secc. Consejos; L. 4953.
- 68 J. H. Elliott, *The Count-Duke of Olivares. The Statesman in an Age of Decline* (New Haven and London: Yale University Press, 1986); M. Rodríguez-Salgado, *Un imperio en transición. Carlos V, Felipe II y su mundo* (Barcelona: Crítica, 1992).
- 69 Hernández Franco, *Cultura y limpieza de sangre*; J. Hernández Franco, 'El partido de los cristianos viejos establece el estatuto de limpieza de sangre el año 1544 en el Cabildo Catedral de Murcia', *Murgetana*, 103 (2000), 57–70; J. Hernández Franco, 'El "consentimiento" del Emperador a los estatutos de limpieza de sangre y el comienzo del viraje hacia la Monarquía Católica', in J. L. Castellano Castellano and F. Sánchez Montes (eds), *Europeísmo y universalidad*, vol. 4 (Madrid: Sociedad Estatal para la Conmemoración de los Centenarios de Felipe II y Carlos V, 2001), pp. 365–86.
- 70 AMM, Act. Cap., 30-06-1556.

- 71 J. P. Dedieu, 'Les causes de foi de l'Inquisition de Tolède (1483–1820). Essai statistique', *Mélanges de la Casa Velázquez*, 14 (1978), 143–71. His work offers very revealing aspects regarding this fact. J. C. Domínguez Nafría, *La Inquisición de Murcia en el siglo XVI: el Licenciado Cascales* (Murcia: Academia Alfonso X el Sabio, 1991).
- 72 AMM, Act. Cap; 1561, fol. 170r.
- 73 AHPM, Martín Faura; 1545-9-2, sig. 617.
- 74 Hernández Franco, *Trayectoria social de una familia conversa*.
- 75 Contreras, *Sotos contra Riquelmes*.
- 76 AHN, Secc. Inq., Carta del Consejo de 11-1-1567; Lib. 575, fols 126r–128r. Order that Murcia's inquisitor priests must keep according to the published *Edicto de Gracia*.
- 77 AMM; 31-3-1570, Lib. 13, serie 3<sup>a</sup>; AHPM, Pedro Suárez; 30-5-1617, sig. 2097, fol. 436.
- 78 F. Bethencourt, *The Inquisition. A Global History* (Cambridge: Cambridge University Press, 2009); R. Kagan and A. Dyer, *Inquisitorial Inquiries: Brief Lives and Other Heretics* (Baltimore: Johns Hopkins University Press, 2004); B. Bennassar, *L'Inquisition espagnole* (Paris: Hachette, 1979); H. Kamen, 'Una crisis de conciencia en la Edad de Oro en España: Inquisición contra limpieza de sangre', *Bulletin Hispanique*, 88/3–4 (1986), 321–35.
- 79 J. Hernández Franco and V. Montojo y Montojo, 'Cultura del honor, linaje-patrón y movilidad social en Cartagena durante los siglos XVI y XVII', *Hispania*, 53/185 (1993), 1000–30.
- 80 I. Pulido Serrano, 'Arbitrismo, comercio y conversos. Reflexiones desde el pensamiento político', in J. Contreras, B. J. García García and I. Pulido (eds), *Familia, Religión y Negocio. El sefardismo en las relaciones entre el mundo ibérico y los Países Bajos en la Edad Moderna* (Madrid: Fundación Carlos de Amberes, Universidad de Alcalá, 2002), pp. 67–94;  
V. M. Godinho, *Os descobrimentos e a Economia Mundial* (Lisbon: Arcadia, 1963); J. C. Boyajian, *Portuguese Trade in Asia under the Habsburgs, 1580–1640* (Baltimore: Johns Hopkins University Press, 1993); J. López-Salazar Pérez, 'Limpieza de sangre y división en estados: el municipio de Almagro durante el siglo XVI', *Studia Historica, Historia Moderna*, 12 (1994), 157–87. J. I. Fortea, *Las Cortes de Castilla y León bajo los Austrias: una interpretación* (Valladolid: Junta de Castilla y León, 2008).
- 81 *Archivo Real Chancillería de Granada* (hereafter ARCG); Cabina 402, L. 3386, Pieza No. 23.
- 82 ARCG; Cabina 402, L. 3386, Pieza No. 23.
- 83 ARCG; Cabina 402, L. 3386, Pieza No. 23.
- 84 ARCG; Cabina 402, L. 3386, Pieza No. 23.

- 85 AHPM, Martín Alonso; 15-11-1557, sig. 7033, fol. 332. AHPM, Juan Gómez; 7-3-1577, sig. 7055, fol. 483.
- 86 ARCG, Cabina 402; L. 3386, pieza No. 23.
- 87 A. M. Hespanha, *La gracia del Derecho* (Madrid: Centro de Estudios Constitucionales, 1993).
- 88 ARCG, Cabina 402; L. 3386, pieza No. 23; Hernández Franco and Ruiz Ibáñez, 'Conflictividad social'; J. I. Israel, *Empires and Entrepots: The Dutch, the Spanish Monarchy and the Jews, 1585–1713* (London: The Hambledon Press, 1990); C. Sanz Ayán, *Los banqueros de Carlos II* (Valladolid: Universidad de Valladolid, 1988).
- 89 R. Descimon, 'Chercher des nouvelles voies pour interpréter les phénomènes nobiliaires dans la France moderne. La noblesse "essence" ou rapport social?', *Revue d'Histoire Moderne et Contemporaine*, 46/1 (1999), 8–17.
- 90 A. Gutiérrez Alonso, 'Consideraciones sobre el matrimonio y la familia de una elite de poder: los regidores de Valladolid (1606–1808)', in J. Casey and J. Hernández Franco (eds) *Familia, linaje y parentesco* (Murcia: Universidad de Murcia, 1997), pp. 269–76.
- 91 M. Mauss, *The Gift: Forms and Functions of Exchange in Archaic Societies* (London: Routledge, 2006); M. Mauss, 'Ensayo sobre los dones', *Sociología y Antropología* (1979), 153–263; L. Racine, *Théories de l'échange et circulation des produits sociaux* (Quebec: Presses de l'Université de Montréal, 1979); A. Caillé (ed.), 'Donner, recevoir et rendre: l'autre paradigme', *Revue du MAUSS*, 11 (1991), 3–89.
- 92 AHN Secc. Consejos; L. 8975, No. 47, fols 460r–461v.
- 93 J. Torres Fontes, *Repartimiento de Orihuela* (Murcia: Academia Alfonso X el Sabio-Patronato 'Ángel García Rogel' de la CAM, 1988); J. Torres Fontes, "'Nobiliario de los Fontes" de Alonso Rodríguez Almela', *Murgetana*, 92 (1996), 21–34.
- 94 Owens, *Rebelión, monarquía y oligarquía*.
- 95 AHPM, Salvador Fernández; 13-3-1593, sig. 202, fol. 1090.
- 96 AHN, Secc. Consejos; L. 4953, fol. 13r.
- 97 A. Álvarez-Ossorio Alvaríño, 'El Favor Real: liberalidad del príncipe y jerarquía de la república (1665–1700)', in C. Continisio and C. Mozzarelli (eds), *Repubblica e Virtú. Pensiero politico e Monarchia Católica fra XVI e XVII secolo* (Rome: Bulzoni, 1995), pp. 393–405; F. Bouza, *Portugal no tempo dos Filipes: política, cultura, representações (1580–1668)* (Lisbon: Cosmos, 2000); B. Yun-Casalilla, *La gestión del poder. Corona y economías aristocráticas en Castilla, siglos XV–XVIII* (Madrid: Akal, 2002); B. Yun-Casalilla, *Marte contra Minerva*; R. G. Asch and A. M. Birke, *Princes, Patronage and the Nobility. The Court at the Beginning of the Modern Age c. 1450–1650* (Oxford: Oxford University Press, 1991); AHN, Secc. Consejos; L. 8975, No. 47, fols 460r–461v.

- 98 D. Saavedra Fajardo, *Empresas Políticas. Idea de un príncipe político-cristiano*, vol. I, empresa 40 (Que Tribvnt Tribvit), 1640, ed. Quintín Aldea Baquero (1976), pp. 377–93.
- 99 A. Álvarez-Ossorio Alvariño, ‘El arte de medrar en la corte: rey, nobleza y el código del honor’, in J. Chacón Jiménez and J. Hernández Franco (eds), *Familia, poderosos y oligarcas*, (Murcia: Universidad de Murcia, 2001), pp. 39–60.
- 100 AHPM, Pedro Rubio; 29-5-1702, sig. 2008, fol. 135; AHN, Secc. Inq.; 1722, L. 1403, No. 13.
- 101 AHN, Secc. Inq.; 1722, L. 1403, No. 13; Ventura Fontes Paz was baptised 21 July 1706 in the parish of San Bartolomé in Murcia. *Archivo Parroquial de San Bartolomé* (hereafter APSB), Libro 10º de bautismos; 21-11-1699/22-6-1709, fol. 327; M. Perez-Garcia and J. Hernández Franco, ‘“Injuria, calumnia y sangre impura”. Banderías y parcialidades desde el Reino de Murcia a Frejenal de la Sierra: el caso de los Paz (siglos XVI–XVIII)’, in *Actas del V Congreso de Historia Social. Las figuras del desorden: heterodoxos, proscritos y marginados* (Ciudad Real, 2005).
- 102 AHPM, Gregorio Buendía; 10-1-1788, sig. 2575, fols 22r–28v.
- 103 Contreras, ‘Criptojudaismo’.
- 104 Pérez, *Historia de una tragedia*; and Caro Baroja, *Los judíos*.
- 105 Contreras, ‘Criptojudaismo’.
- 106 S. Aragón Mateos, *La nobleza extremeña en el siglo XVIII* (Mérida: Biblioteca Pública Municipal Juan Pablo Forner, 1991); A. Gil Soto, *Deudos, parciales y consortes. Estrategias políticas y sociales de la oligarquía rural extremeña (siglos XVII y XVIII)* (Cáceres: Universidad de Extremadura, 2003).
- 107 AHN, Secc. Inq.; 1722, L. 1403, No. 13.
- 108 AHN, Secc. Inq., Leg. 1403, No. 13, 1722.
- 109 AHN, Secc. Inq., Leg. 1403, No. 13, 1722.
- 110 A.H.N., Secc. Inq., Leg. 1403, No. 13, 1722
- 111 Hernández Franco, *Cultura y limpieza de sangre*.
- 112 AHN, Secc. Inq.; 1722, L. 1403, No. 13.
- 113 Contreras, ‘Criptojudaismo’.
- 114 AHN, Secc. Inq., Leg. 1403, No. 13, 1722
- 115 AHN, Secc. Inq.; 1722, L.1403, No. 13.
- 116 Contreras, ‘Criptojudaismo’; J. Contreras, ‘Procesos culturales hegemónicos: de la religión y religiosidad en la España del Antiguo Régimen’, *Historia Social*, 35 (1999), 3–22.
- 117 Dedieu, ‘Les causes de foi de l’Inquisition de Tolède’.
- 118 AHN, Secc. Inq.; 1722, L. 1403, No. 13, fol. 197r.
- 119 J. A. Martínez Bara, ‘Los actos positivos y su valor en las pruebas genealógicas y nobiliarias en el siglo XVII’, in J. Pérez Villanueva (ed.), *La Inquisición española. Nueva visión, nuevos horizontes* (Madrid: Siglo XXI, 1980), p. 310.

- 120 Elliott, *La España Imperial*.
- 121 AHN, Secc. Inq., Leg. 1403, No. 13, 1722
- 122 AHN, Secc. Inq.; 1722, L. 1403, No. 13.
- 123 Caro Baroja, *Los judíos*; J. Contreras, 'Historiar a los judíos de España: un asunto de pueblo, nación y etnia', in A. Mestre Sanchís and E. Giménez López (eds), *Disidencias y exilios en la España Moderna* (Alicante: Universidad de Alicante, 1997), pp. 117–44.
- 124 AHN, Secc. Inq.; 1722, L. 1403, No. 13.
- 125 AHN, Secc. Consejos; L. 4953, fols 48r–104v.
- 126 AHN, Secc. Inq.; 1722 L. 1403, No. 13; AHN, Secc. Consejos; L. 4953, fol. 48r.
- 127 AHN, Secc. Inq., Leg. 1403, No. 13, 1722; AHN., Secc. Consejos, L. 4953, fol. 48r.
- 128 A. Peñafiel Ramón, 'Notas para el estudio de la organización burocrática inquisitorial: los familiares del Santo Oficio murciano en el siglo XVIII', *Murgetana*, 80 (1990), 29–42; J. Contreras, 'La infraestructura social de la Inquisición: comisarios y familiares', in A. Alcalá et al. (eds), *Inquisición española y mentalidad inquisitorial* (Barcelona: Editorial Aries, 1984), pp. 123–46; R. García Cárcel, 'Número y sociología de los familiares de la Inquisición valenciana', in J. Pérez Villanueva (ed.), *La Inquisición española. Nueva visión, nuevos horizontes* (Madrid: Siglo XXI, 1980), pp. 271–84.
- 129 J. J. Ruíz Ibáñez, *Las dos caras de Jano. Monarquía, ciudad e individuo. Murcia, 1588–1648* (Murcia: Universidad de Murcia, 1995); Contreras, 'Linajes y cambio social'.
- 130 AHN, Secc. Inq., L. 1403, No. 13, 1722; AHN, Secc. Consejos, L. 4953, fol. 48r.
- 131 AHN, Secc. Inq., L. 1403, No. 13, 1722; AHN, Secc. Consejos, L. 4953, fol. 48r.
- 132 C. López González, E. Postigo Castellanos and J. I. Ruiz Rodríguez, 'Las órdenes Militares castellanas en la época Moderna: una aproximación cartográfica', in *Las Órdenes Militares en el Mediterráneo Occidental (siglos XII–XVIII)* (Madrid: Casa de Velázquez, 1989), pp. 291–340; E. Postigo Castellanos, *Honor y privilegio en la Corona de Castilla. El Consejo de las Ordenes y los caballeros de hábito en el siglo XVII* (Valladolid: Junta de Castilla y León, 1988).
- 133 Elliott, *The Count-Duke of Olivares*.
- 134 M. Lambert-Gorges, 'Imágenes de la familia y de la respetabilidad social a través de las encuestas de las Ordenes Militares', in J. Hernández Franco (ed.), *Familia y poder. Sistemas de reproducción social en España (siglos XVI–XVIII)* (Murcia: Universidad de Murcia, 1995), pp. 49–79.
- 135 M. Lambert-Gorges, 'Le bréviaire du bon enquêteur, ou trois siècles d'information sur les candidats à l'habit des ordres militaires',

- Mélanges de la Casa Velázquez*, 18 (1982), 165–98; García de Medrano, *La regla y establecimiento de la cavalleria de Santiago de la Espada. Con la Historia del origen y principio della*, 1627, second edn (Madrid: Facsímil, 1991).
- 136 J. Hernández Franco, ‘Cultura de elites y estratificación social en la España Moderna. Aproximación metodológica a través de los estatutos e informaciones de limpieza de sangre’, in J. Hernández Franco (ed.), *Familia y poder. Sistemas de reproducción social en España (siglos XVI–XVIII)* (Murcia: Universidad de Murcia, 1995), pp. 81–99.
- 137 AHN, Secc. Consejos; 1709, L. 37630, Ejecutoria No. 1068.
- 138 AHN, Secc. OOMM, Santiago; E. 7025; AHN, Secc. OOMM, Santiago; E. 2072.
- 139 AHN, Secc. Consejos; 1709, L. 37630, No. 1068; AHN, Secc. OOMM, Santiago; E. 2027; AHN, Secc. OOMM, Santiago; E. 7025; ARCG, Cabina 402; L. 3406, Pieza No. 17; AHN, Secc. OOMM, Santiago; E. 7090; AHN, Secc. OOMM, Santiago; E. 7088; ARCG, Cabina 402; L. 3410, Pieza No. 11, hoja 56; AHPM, Francisco Juto de Oces; 3-7-1627, sig. 1460, fols 697r–703r; AHPM, Melchor González de la Vega; 21-5-1631, sig. 1293, fol. 544; AHN, Secc. OOMM, Santiago; E. 3125; AHN, Secc. OOMM, Alcántara; E. 553; AHPM, Jacinto Ferrer; 17-1-1641, sig. 1173, fol. 554; AHPM, Jacinto Ferrer; 17-1-1641, sig. 1173, fol. 554; AHPM, Jacinto Ferrer; 17-1-1641, sig. 1173, fol. 554; AHPM, Pedro Ferrer; 31-10-1642, sig. 1149, fol. 626; AHN, Secc. OOMM, Santiago; E. 3128; AHPM, Cristóbal Vilchez Ruíz; 1655, sig. 2186, fol. 1348; AHN, Secc. OOMM, Montesa; L. 860; AHN, Secc. OOMM, Calatrava; E. 1140; AHN, Secc. OOMM, Alcántara; E. 554; AHN, Secc. OOMM, Santiago; E. 3126; AHN, Secc. OOMM, Santiago; E. 3127; AHN, Secc. OOMM, Calatrava; E. 12003; AHN, Secc. OOMM, S. Juan; E. 23472; AHN, Secc. OOMM, Montesa; L. 87; AHN, Secc. OOMM, Montesa; L. 86.
- 140 L. García-Guijarro Ramos, ‘Los orígenes de la Orden de Montesa’, *Las Órdenes Militares en el Mediterráneo Occidental (siglos XII–XVIII)* (Madrid: Casa de Velázquez, Instituto de Estudios Manchegos, 1989), pp. 69–83.
- 141 F. Fernández Izquierdo, ‘La Orden de Calatrava en la Edad Moderna’, in *Las Órdenes Militares en el Mediterráneo Occidental (siglos XII–XVIII)* (Madrid: Casa de Velázquez, Instituto de Estudios Manchegos, 1989), pp. 181–212.
- 142 AHPM, Damián Alborno; 1613, sig. 684, fols 243r–245v.
- 143 *Archivo Parroquial de San Miguel* (hereafter APSM); L. 4º de velaciones; AHN, Secc. OOMM, Montesa; 1725, L. 87.
- 144 AMM; 1771, sig. 3727 (II).

- 145 AHN, Secc. OOMM, Montesa; 1757, L. 86; Francisco Andújar Castillo has pointed out that 'it was common for families to direct *vástagos* to a military career for all to serve in the same regiment'. Several members of the Caro family mentioned in the text were part of the regiment of the kingdom of Valencia. F. Andújar Castillo, *El sonido del dinero. Monarquía, ejército y venalidad en la España del siglo XVIII* (Madrid: Marcial Pons, 2004), p. 127.
- 146 AHN, Secc. OOMM, Montesa; 1757, L. 86, L. 84, L. 85.
- 147 AHN, Secc. OOMM, Montesa; 1757, L. 86.
- 148 AHN, Secc. OOMM, S. Juan; L. 23472.
- 149 AMM; 1771, sig. 3727 (II).
- 150 A. Domínguez Ortiz, *La sociedad española del siglo XVIII* (Madrid: Ariel, 1955).
- 151 F. Andújar Castillo, *Los militares en la España del siglo XVIII. Un estudio social* (Granada: Universidad de Granada 1991); F. Andújar Castillo, *Consejo y consejeros de guerra en el siglo XVIII* (Granada: Universidad de Granada, 1997).
- 152 F. Velasco Hernández, *Auge y estancamiento de un enclave mercantil en la periferia. El nuevo resurgir de Cartagena entre 1540 y 1676* (Murcia: Academia Alfonso X el Sabio-Ayuntamiento de Cartagena, 2001).
- 153 ARCG, Cabina 402; L. 3406, Pieza No. 17.
- 154 AMM, Cofradía de Santiago de la Espada (1771–1816), Cabildos y Cuentas (1803); L. 3727; ARCG, Cabina 402; L. 3406, Pieza No. 17; AHN, Secc. Inq., L. 1405, No. 13, 1788; ARCG, Cabina 402; L. 3418, Pieza No. 5; AHN, Secc. OOMM, Montesa; 1757, L. 86; AHN, Secc. OOMM, Montesa; 1757, L. 84; AHN, Secc. OOMM, Montesa; 1757, L. 85; AHN, Secc. OOMM, Montesa; 1725, L. 87; AHN, Secc. Inq.; 1722, L. 1403, No. 13.
- 155 As has been mentioned before, the marquisate of Pinares was granted to Bernardo Riquelme y Salafranca in 1763 due to the policy of favours that was established between the Molina family and the Riquelme Salafranca. Cardinal Molina, president of the *Consejo de Castilla* between 1733 and 1744, favoured the aforesaid family as his niece, María Antonia Rocha, was married to Bernardo Riquelme y Salafranca. As the granting of *corregimientos* was the Cardinal's prerogative, in his capacity of president of the *Consejo de Castilla*, in December 1739 he appointed Bernardo Riquelme y Salafranca *corregidor* of Alcalá la Real, Loja and Alhama. The same cardinal might have been the one to grant him, in 1744, a seat as *consejero supernumerario* of *Hacienda*. He favoured Justo Riquelme in his military career. He served first as *guardamarina* (1741) and later as navy lieutenant (1757). Thanks to these family ties and favours he received the nobiliary title of marquis of Pinares. We must make clear that both of



his surnames, Molina and Rocha, helped him greatly in obtaining these favours. The name Rocha was of great importance, and with one of his seats in Merida, was tied to this family. Therefore we highlight two notorious characters related to the Riquelme Salafranca family: Don Fernando Antonio de la Rocha y Guillasmas, *regidor* of Mérida, who served in a *corregimiento* in Écija; and the previously mentioned Molina, father to María Antonia de Rocha, Juan de Molina, was *corregidor* of Granada; her brother, Juan de Molina, was marquis of Ureña; and the first cousin of the previously mentioned María Antonia, Gaspar de Molina, was bishop of Almería. AHN, Secc. Inq.; 1788, L. 1405, No. 13. F; Andújar Castillo, *El sonido del dinero*, pp. 177, 179, 180, 182, 213. The title of marquis of Torre Pacheco would be inserted in the so-called *títulos blancos* (that is, titles granted by the crown, with no particular beneficiary), to a specific institution so that this institution would be able to sell it and collect money for it. Therefore, the aforesaid title was bought in 1690 by Don Macías Fontes Carrillo, and it had been granted by the crown to the cathedral's *cabildo* so that the *cabildo* could use the funds obtained from the sale as means to subsidise the expenses of the sacristy or Murcia's cathedral, which was burned down in 1689. Rodríguez Llopis, *Historia de la Región de Murcia*.

156 AHN, Secc. Inq.; 1788, L. 1405, No. 13.

157 A. Peñafiel Ramón, *Fiesta y celebración política de los primeros Borbones* (Murcia: Academia Alfonso X el Sabio, 1988); J. C. Domínguez Nafría, 'La nobleza en el Reino de Murcia', in M. C. Iglesias Cano (ed.), *Nobleza y sociedad III: las noblezas españolas, reinos y señoríos en la Edad Moderna* (Oviedo: Nobel, 1999), pp. 101–43.

158 F. Tomás y Valiente, *Gobierno e instituciones en la España del Antiguo Régimen* (Madrid: Alianza, 1982); F. J. Guillamón Álvarez, *Regidores de la ciudad de Murcia (1750–1836)* (Murcia: Academia Alfonso X el Sabio, 1989).

159 AMM; 1797, sig. 3727 (II); AMM; 1771, sig. 3727 (II); AMM, Cartularios Reales; 1771, sig. 863 (II), rollo 50, fol. 592; AMM; 1804, sig. 3727; AMM; 1759, sig. 3727 (I), s.n.; AMM, Cartas Reales; 1759, rollo 37, fols 783r–789v; AHPM, Pedro Fajardo; 11-9-1758, sig. 2805, fol. 132r–v; AHN, Secc. Inq.; L. 1405; Owens, 'Los regidores y jurados de Murcia'.

160 AMM; 1797, sig. 3727 (II); AMM; 1804, sig. 3727 (II); AHN, Secc. OOMM, Santiago; E. 3124; AHN, Secc. Inq.; 1788, L. 1405, No. 13; AHN, Secc. OO.MM, S. Juan; E. 23472.

161 AHPM, Pedro Fajardo; 11-9-1758, sig. 2805, fol 132r–v.

162 Tomás y Valiente, *Gobierno e instituciones*.

163 AMM, Cartas Reales; 26-10-1759, Rollo 37, fol. 783r–v.

164 Guillamón Álvarez, *Regidores*; AMM; 1804, sig. 3727 (II).

- 165 AMM; 1771, sig. 3727 (II).
- 166 AMM; 1797, sig. 3727 (II); AMM; sig. 3727, s.n.; AMM; 1804, sig. 3727.
- 167 A. Rumeu de Armas, *Historia de la previsión social en España* (Barcelona: El Albir, 1981); A. Peñafiel Ramón, *Mentalidad y religiosidad popular murciana en la primera mitad del siglo XVIII* (Murcia: Universidad de Murcia, 1988); N. Terpstra, *Lay Confraternities and Civic Religion in Renaissance Bologna* (Cambridge: Cambridge University Press, 1995).
- 168 A. Peñafiel Ramón, *Testamento y buena muerte: un estudio de las mentalidades en la Murcia del siglo XVIII* (Murcia: Real Academia Alfonso X el Sabio, 1987); E. Sánchez de Madariaga, 'Cultura religiosa y sociedad: las cofradías de laicos', *Historia Social*, 35 (1999), 23–42.
- 169 C. Chauchadis, 'Les modalités de la fermeture dans les confréries espagnoles, XVIe–XVIIIe siècle', *Les sociétés fermées dans le monde ibérique, XVIe–XVIIIe siècle* (Paris: CNRS, 1986), pp. 83–105; M. C. Gerbet, 'Les confréries religieuses à Cáceres de 1467 à 1523', *Mélanges de la Casa Velázquez*, 7 (1971), 79–113.
- 170 Hernández Franco, *Cultura y limpieza de sangre*; M. A. Sobaler Seco, "'La Cofradía de nobles caballeros de Santiago" de Soria (1572): un intento frustrado de corporativismo nobiliar', *Investigaciones Históricas*, 12 (1992), 11–29.
- 171 J. Pérez Balseira, *Biblioteca histórica y genealógica. Los caballeros de Santiago*, vol. 3 (Madrid: E. Mestre, 1933), p. 132; García de Medrano, *Regla y establecimientos de la cavallería de Santiago de la Espada. Con la Historia del origen y principio della*, 1627, 2nd edn (Madrid: Facsímil, 1991).
- 172 AMM, Cofradía de Santiago de la Espada (1771–1816), Cabildos y Cuentas (1803); 18-6-1798, L. 3728.
- 173 AMM, Cofradía de Santiago de la Espada (1771–1816), Cabildos y Cuentas (1803); 7-6-1784, L. 3728.
- 174 AMM; 1797, sig. 3727 (II); AMM, Cofradía de Santiago de la Espada (1771–1816), Cabildos y Cuentas (1803); L. 3728; AMM; 1804, sig. 3727 (II); AHN, Secc. OOMM; S. Juan, E. 23472; AHN, Secc. Inq.; 1788, L. 1405, No. 13; AHPM, Pedro Rubio; 29-5-1702, sig. 2008, fol. 135.
- 175 A. Peñafiel Ramón, 'Inquisición murciana y reorganización de la Cofradía de S. Pedro Mártir de Verona (siglo XVIII)', *Revista de la Inquisición*, 9 (2000), 87–100. The aforesaid San Pedro would have been considered *Patrón y Protector de la Cofradía*, given his relationship with the Tribunal of the Inquisition. Born in the city of Verona around the beginning of the thirteenth century, he would have acted as inquisitor in Milan and Cremona in Italy, and later on, facing the Cathars, have his name even considered as founder of the *Santo Oficio* of Florence. He was appointed grand inquisitor by Pope Gregory IX. J. C. Galende Díaz, 'La Cofradía de S. Pedro Mártir en los Tribunales

- Inquisitoriales del Levante español: Valencia y Murcia', in *Religiosidad popular en España* (San Lorenzo del Escorial: Real Centro Universitario Escorial-María Cristina, 1997), pp. 1007–26.
- 176 AMM, Constituciones de la Ilustre Cofradía del Glorioso Mártir San Pedro de Berona, de la Inquisición de Murcia, Imprenta Díaz Cayuelas; 1749, C. 2.
- 177 AMM, Constituciones de la Ilustre Cofradía del Glorioso Mártir San Pedro de Berona, de la Inquisición de Murcia, Imprenta Díaz Cayuelas; 1749, C. 3.
- 178 AMM, Constituciones de la Ilustre Cofradía del Glorioso Mártir San Pedro de Berona, de la Inquisición de Murcia, Imprenta Díaz Cayuelas; 1749, C. 4.
- 179 AHN, Secc. OOMM, Montesa; 1757, L. 87; AHPM, Pedro Suárez; 1617, sig. 2097, fol. 436; AHPM, Pedro Rubio; 29-5-1702, sig. 2008, fol. 135.
- 180 AMM, Constituciones de la Ilustre Cofradía del Glorioso Mártir San Pedro de Berona, de la Inquisición de Murcia, Imprenta Díaz Cayuelas; 1749, pp. 51–9.
- 181 AHN, Secc. Inq.; 1788, L. 1405, No. 13; AHN, Secc. OOMM, Montesa; 1757, L. 86; AHN, Secc. Consejos; 1709, L. 37630, Ejecutoria No. 1068; AHPM; 1631, sig. 1293, fol. 544; AHPM; sig. 1460, fols 697–703r; AHN, Secc. Consejos; L. 4953; AHN, Secc. OOMM, Calatrava, E. 1138, 1565; AHN, Secc. OOMM, Santiago; E. 312; AHPM, Pedro Rubio; 29-5-1702, sig. 2008, fol. 135; AHN, Secc. Inq.; 1722, L. 1403, No. 13; AHN, Secc. Inq.; 1788, L. 1405, No. 13; AHN, Secc. OOMM, Alcántara; E. 554; AHN, Secc. OOMM, Montesa; 1757, L. 86.
- 182 AHN, Secc. OOMM, Montesa; 1757, L. 86; AHN, Secc. OOMM, Montesa; 1757, L. 84.
- 183 B. Cuart Moner, *Colegios Mayores y limpieza de sangre durante la Edad Moderna. El estatuto de S. Clemente de Bolonia (siglos XV–XIX)* (Salamanca: Universidad de Salamanca, 1991); B. Cuart Moner, “Familias colegiales” y familias de colegiales: fuentes y metodología para el estudio de una elite de poder”, in J. Hernández Franco (ed.), *Familia y poder. Sistemas de reproducción social en España (siglos XVI–XVIII)* (Murcia: Universidad de Murcia, 1995), pp. 49–79.
- 184 AMM; 1804, sig. 3727 (II).
- 185 E. Fontes Fuster, *Nuestra Heráldica (Historia de la familia Fontes y otras enlazadas con ella)* (Murcia: M. Arenas, 1936), p. 263.

### Chapter 3

- 1 J. Kok, ‘Principles and Prospects of the Life Course Paradigm’, *Annales de Démographie Historique* 1 (2007), 203–30; V. Pérez Moreda, ‘Matrimonio y familia. Algunas consideraciones sobre el modelo

- matrimonial español en la Edad Moderna', *Boletín de la Asociación de Demografía Histórica*, 4 (1986), 3–51.
- 2 Casey, *Family and Community*.
  - 3 P. Laslett, 'The Character of Familial History, its Limitations and the Conditions for its Proper Pursuit', *Journal of Family History*, 12 (1987), 263–84; P. Laslett, 'Age at Menarche in Europe since the Eighteenth century', *Journal of Interdisciplinary History*, 2/2, *The History of the Family* (Autumn 1971), 221–36; H. C. Johansen, 'Urban Social and Demographic Reconstitution: The Case of Eighteenth-Century Odense', *History and Computing*, 11 (1999), 115–28; Perez-Garcia, 'Social Networks and Kinship'; J. Carvalho and R. Campos, 'Interpersonal networks and the archaeology of social structures; using social positioning events to understand social strategies and individual behavior', *Revista de História da Sociedade e da Cultura*, 7 (2007), 175–93; J. M. Imízcoz Beunza, 'Patronos y mediadores. Redes familiares en la monarquía y patronazgo en la aldea: la hegemonía de las elites baztanesas en el siglo XVIII', in J. M. Imízcoz Beunza (ed.), *Redes familiares y patronazgo. Aproximación al entramado social del País Vasco y Navarra en el Antiguo Régimen (siglos XV–XIX)* (Bilbao: Universidad del País Vasco, 2001), pp. 225–61.
  - 4 I. Atienza Hernández, 'Consenso, solidaridad vertical e integración versus violencia en los señoríos castellanos del siglo XVIII y la crisis del Antiguo Régimen', in E. Sarasa and E. Serrano (eds), *Señorío y Feudalismo en la Península Ibérica (siglos XII–XIX)*, vol. 2 (Zaragoza: Institución Fernando el Católico, 1993), pp. 275–318; A. Domínguez Ortiz, *Las clases privilegiadas*.
  - 5 J. Bestard and M. Perez-Garcia (eds), *Familia, valores y representaciones* (Murcia: Universidad de Murcia, 2010); J. Bestard, *Casa y Familia. Parentesco y reproducción doméstica en Formentera* (Palma de Mallorca: Institut d'Estudis Baleàrics, 1986).
  - 6 P. P. Viazzo, 'What's So Special About Mediterranean? Thirty Years of Research on Household and Family in Italy', *Continuity and Change*, 18 (2003), 111–37; M. Bloch, 'Pour une histoire comparée des sociétés européennes', *Revue de synthèse historique* 46 (1928), 15–50.
  - 7 F. Chacón Jiménez, 'Continuidad de costumbres y transmisión de la propiedad en el sistema familiar castellano, siglos XVI–XVIII', in F. Chacón Jiménez (ed.), *Historia social de la familia en España: aproximación a los problemas de familia, tierra y sociedad en Castilla (siglos XV–XIX)* (Alicante: Diputación Provincial de Alicante, Instituto Alicantino de Cultura Juan Gil-Albert, 1990), pp. 47–60.
  - 8 M. Perez-Garcia, 'Trayectoria social de un linaje murciano del siglo XVIII: los Riquelme', in F. A. Chacón Gómez-Monedero, X. Roigé, E. Rodríguez Ocaña (eds), *Familias y poderes: actas del VII Congreso*

- Internacional de la ADEH, 2006* (Granada: Universidad de Granada, 2006), pp. 159–72.
- 9 AMJ, Fondo Soto Molina; L. 17, E. 306; Torres Fontes, ‘Los Fajardo’.
- 10 Maczak, ‘From aristocratic household’; A. Janssens, ‘The History of Male Breadwinning: a Story about Economics, Power, and Identity’, in J. Ehmer, H. Grebing and P. Gutschner (eds), *Arbeit: Geschichte – Gegenwart – Zukunft* (Vienna: Akademische Verlagsanstalt, 2002), pp. 101–18; Peñafiel Ramón and Hernández Franco, ‘Parentesco, linaje y mayorazgo’; C. Windler, ‘Cliëntèles royales et cliëntèles seigneuriales vers la fin de l’Ancien Régime. Un dossier espagnol’, *Annales*, HSS, 52 (1997), 293–319; F. Martínez Rueda, ‘Poder local y oligarquías en el País Vasco: las estrategias del grupo dominante en la comunidad tradicional’, in J. M. Imízcoz Beunza (ed.), *Elites, poder y red social* (Bilbao: Universidad del País Vasco, 1996), pp. 119–46.
- 11 AMJ, Fondo Soto Molina; L. 17, E. 306.
- 12 J. Kok, ‘Church Affiliation and Life Course Transitions in The Netherlands, 1850–1970’, *Historical Social Research*, 42/2 (2017), 59–9; A. Janssens, *Family and Social Change. The Household as a Process in an Industrializing Community* (Cambridge: Cambridge University Press, 1993).
- 13 H. Carvalhal, ‘Lineage, Marriage and Social Mobility: the Teles de Meneses Family in the Iberian Courts (Fifteenth and Sixteenth Centuries)’, *e-Journal of Portuguese History*, 14 (2016), 2–19; J. L. Palos, ‘Eleonora Álvarez de Toledo (1522–62): “A Spanish Barbarian and an Enemy of her Husband’s Homeland”: the Duchess of Florence and her Spanish Entourage’, in J. L. Palos and M. Sánchez (eds), *Early Dynastic Marriages and Cultural Transfer* (Farnham: Ashgate, 2016), pp. 165–87; P. J. Pla Alberola, ‘Familia y matrimonio en la Valencia Moderna. Apuntes para su estudio’, in P. Vilar (ed.), *La familia en la España mediterránea (siglos XV–XIX)* (Barcelona: Crítica, 1987), pp. 94–128.
- 14 G. Delille, ‘La historia de la familia en Italia: trabajos recientes y problemas metodológicos’, in F. Chacón Jiménez (ed.), *Familia y sociedad en el Mediterráneo Occidental. Siglos XV–XIX*, (Murcia: Universidad de Murcia, 1987), pp. 263–78; G. Delille, *Famille et propriété dans le Royaume de Naples, XVe–XIXe siècle* (Paris: EHESS, 1988).
- 15 S. Tarbin and S. Broomhall (eds), *Women, Identities and Communities in Early Modern Europe* (Aldershot: Ashgate, 2007); C. Fernández Cortizo, ‘Espacios matrimoniales y reproducción social en la Galicia Occidental del siglo XVIII’, *Revista de Demografía Histórica*, 22/1 (2004), 77–109; J. Bestard, *Parentesco y modernidad* (Barcelona: Paidós, 1998).

- 16 Figure based on author's elaboration. Marriage model of union of Riquelme and Fajardo (Lorenzo Riquelme de Barrientos and Isabel Fajardo; Salvadora Riquelme and Juan Fajardo).
- 17 Figure based on author's elaboration. Marriage model of union of families Riquelme and Comontes (Diego Riquelme and Aldonza Villagomez de Comontes; Martín Riquelme and María Villagomez de Comontes).
- 18 AMJ, Fondo Soto Molina; L. 17, E. 306; A. Irigoyen López, 'Clero secular, familia y movilidad social: actores y directores', in F. Chacón Jiménez and J. Hernández Franco (eds), *Familia, poderosos y oligarquías* (Murcia: Universidad de Murcia, 2001), pp. 131–52; A. Irigoyen López, *Entre el cielo y la tierra, entre la familia y la institución. El cabildo de la catedral de Murcia en el siglo XVII* (Murcia: Universidad de Murcia, 2000).
- 19 Archivo Histórico Provincial de Murcia (hereafter AHPM), Deogracias Serrano de la Parra; 14-6-1844, sig. 4961, fol. 1333v.
- 20 J. Tarrade, 'Exogamie et endogamie dans les régions rurales du centre-ouest de la France au XVIIIe siècle', in J. Goyand and J. P. Wallot (eds), *Évolution et éclatement du monde rural* (Paris: École des Hautes Études en Sciences Sociales, 1986), pp. 513–32; C. Sauvain-Dugerdil and Ph. Richard, 'Le cercle des unions: une définition dynamique de la population ou de la pertinence d'une convergence entre l'anthropologie biologique et la démographie historique', in G. Brunet, A. Fauve-Chamoux and M. Oris (eds), *Le choix du conjoint* (Lyon: PPSH, 1998), pp. 27–45.
- 21 F. Chacón Jiménez, 'Notas para el estudio de la familia en la región de Murcia durante el Antiguo Régimen', in F. Chacón Jiménez (ed.), *Historia Social de la Familia en España: aproximación a los problemas de familia, tierra y sociedad en Castilla (siglos XV–XIX)* (Alicante: Diputación Provincial de Alicante, Instituto Alicantino de Cultura Juan Gil-Albert, 1990), pp. 101–36; A. Moreno Almárcegui, 'Pequeña nobleza rural, sistema de herencia y estructura de la propiedad de la tierra en Plasencia del Monte (Huesca), 1600–1855', in F. Chacón Jiménez and J. Hernández Franco (eds), *Poder, familia y consanguinidad en la España del Antiguo Régimen* (Barcelona: Anthropos, 1992), pp. 71–106.
- 22 AMJ, Fondo Soto Molina; L. 17, E. 306.
- 23 AMJ, Fondo Soto Molina; L. 17, E. 306.
- 24 Delille, *Le maire et le prieur*.
- 25 F. Chacón Jiménez, 'Introducción a la Historia de la Familia en España. El ejemplo de Murcia y Orihuela (siglos XVII–XIX)', in F. Chacón Jiménez (ed.), *Historia Social de la Familia en España: aproximación a los problemas de familia, tierra y sociedad en Castilla (siglos*

- XV–XIX) (Alicante: Diputación Provincial de Alicante, Instituto Alicantino de Cultura Juan Gil-Albert, 1990), pp. 137–64; R. O'Day, 'The household life-cycle', in R. O'Day (ed.), *The Family and Relationships, 1500–1900: England, France and the United States of America* (London: Macmillan, 1994), pp. 11–19.
- 26 Cerutti, 'La construction des catégories'.
- 27 Bourdieu, *Le sens pratique*; R. Wolf, 'Relaciones de parentesco, de amistad y de patronazgo en las sociedades complejas', in R. Wolf (ed.), *Antropología de las sociedades complejas* (Madrid: Alianza, 1990).
- 28 M. Bertrand, 'Familles, fidèles et réseaux: les relations sociales dans une société d'Ancien Régime', in J. L. Castellano and J. P. Dedieu (eds), *Réseaux, familles et pouvoirs dans le monde ibérique à la fin de l'Ancien Régime* (Paris: CNRS, 1998), pp. 169–90.
- 29 Delille, *Le maire et le prieur*.
- 30 Author's own elaboration; AHPM, sig. 2097, fol. 436, 30-5-1617, escr. Pedro Suárez; AHPM, sig. 1149, fol. 626, 31-10-1642, escr. Pedro Ferrer; AHPM, sig. 4961, fol. 1333v, 14-6-1844, escr. Deogracias Serrano de la Parra; Irigoyen López, *Entre el cielo y la tierra*.
- 31 Years in which the entailed estate is founded and the *prebenda* is exercised by Macías and Luis Coque; AHPM, Deogracias Serrano de la Parra; 14-6-1844, sig. 4961, fol. 1333v.
- 32 AMJ, Fondo Soto Molina; L.17, E. 306.
- 33 J. Bestard Camps, 'La estrechez del lugar. Reflexiones en torno a las estrategias matrimoniales cercanas', in F. Chacón Jiménez and J. Hernández Franco (eds), *Poder, familia y consanguineidad en la España del Antiguo Régimen* (Barcelona: Anthropos, 1992), pp. 107–56.
- 34 AHN, Sección Consejos; L. 4953. The aforementioned bonds, which constitute the starting point for the wealth of the Riquelme family, through the establishment of entailed estates, will be dealt with in a chapter devoted to the topic.
- 35 Casey, *Family and Community*; A. Rodríguez Sánchez, 'El poder y la familia. Formas de control y de consanguineidad en la Extremadura de los tiempos modernos', in F. Chacón Jiménez and J. Hernández Franco (eds), *Poder, familia y consanguineidad en la España del Antiguo Régimen* (Barcelona: Anthropos, 1992), pp. 15–34.
- 36 M. C. Barbazza, 'Propiedad campesina y transmisión en Castilla la Nueva en los siglos XVI y XVII', in F. García González (ed.), *Tierra y Familia en la España Meridional, siglos XIII–XIX* (Murcia: Universidad de Murcia, 1998), pp. 87–102.
- 37 Casey, *Family and Community*.
- 38 Delille, 'La historia de la familia'.
- 39 F. Chacón Jiménez, 'Hacia una nueva definición de la estructura social en la España del antiguo régimen a través de la familia y las relaciones de parentesco', *Historia Social*, 21 (1995), 75–104.

- 40 Fernández Cortizo, 'Espacios matrimoniales'.
- 41 M. Segalen, 'Mariage et parentèle dans le pays bigouden sud: un exemple de renchéatement d'alliance', in F. Héritier-Augé and É. Copet-Rougier (eds), *Les complexités de l'alliance. Les systèmes complexes d'alliance matrimoniale*, vol. 2 (Paris: Éditions des Archives Contemporaines, 1991), pp. 177–205 ; G. Lenclud, 'Mariage, transmission des biens et reproduction sociale dans la Corse traditionnelle', in F. Héritier-Augé and É. Copet-Rougier (eds), *Les complexités de l'alliance. Les systèmes complexes d'alliance matrimoniale*, 2 (Paris: Éditions des Archives Contemporaines, 1991), pp. 147–76.
- 42 AHPM, Damián Albornoz; 1613, sig. 684, fols 243r–245v; D. de la Válgoma y Díaz-Varela, *Los Saavedra y los Fajardo en Murcia* (Murcia: Academia Alfonso X el Sabio, 1957).
- 43 Bestard, *Parentesco y modernidad*.
- 44 Table prepared by the author; AMJ, Fondo Soto Molina, L. 17, E. 306; AHPM, sig. 617, fol. 909, 15-4-1544, escr. Martín Faura; AHPM, sig. 206, fol. 896, 24-10-1596, escr. Salvador Fernández; AHPM., sig. 1033, fols 217r–222r., escr. Pedro Fernández Reolid; AHPM, sig. 684, fols 243r–245v., 1613, escr. Damián Albornoz; AHPM, sig. 4222, fols 1296r–1301v., 22-10-1798, escr. Juan Mateo Atienza; Fontes Fuster, *Nuestra Heráldica*.
- 45 AMJ, Fondo Soto Molina; L. 17, E. 306.
- 46 AHPM, Martín Faura; 15-4-1544, sig. 617, fol. 909.
- 47 AHPM, Pedro Fernández de Reolid; 1617, sig. 1033, fols 217r–222r.
- 48 AHPM, Damián Albornoz; 1613, sig. 684, fols 243r–245v; AHPM, Salvador Fernández; 13-3-1593, sig. 202, fol. 1090.
- 49 AHPM, Salvador Fernández; 13-3-1593, sig. 202, fol. 1090.
- 50 Archivo Parroquial de San Bartolomé (hereafter APSB), Libro 3° de bautismos (18-1-1586/1-5-1603); fol. 341.
- 51 AHPM, Juan Mateo Atienza; 22-10-1798, sig. 4222, fols 1296r–1301r.
- 52 AHPM, Juan Mateo Atienza; 22-10-1798, sig. 4222, fols 296r–1301r.
- 53 Who tested it in 1648; AHPM, Pedro Alcázar; sig. 740, fol. 321; Archivo Parroquial de San Lorenzo (hereafter APSL), Libro 2° de bautismos (1583/1607), Bonte fol. 50r.
- 54 A. Guerreau-Jalabert, 'Prohibitions canoniques et stratégies matrimoniales dans l'aristocratie médiévale de la France du Nord', in P. Bonte (ed.), *Épouser au plus proche. Inceste, prohibitions et stratégies matrimoniales autour de la Méditerranée* (Paris: Éditions de l'École des Hautes Études en Sciences Sociales, 1994), pp. 293–321.
- 55 AHPM, Ventura Blanes y Rubio; 4-7-1775, sig. 2527, fols 7r–12v; Archivo Parroquial de San Nicolás (hereafter APSN), Libro de Velaciones No 5; 1749.
- 56 AHPM, Ventura Blanes y Rubio; 4-7-1775, sig. 2527, fols 7r–12v; AHPM; 1769, sig. 2520, fols 27r–38v; F. Chacón Jiménez, 'Hacia una



- nueva definición'; AHPM, Ventura Blanes y Rubio; 25-5-1790, sig. 2527, fols 40r-43r.
- 57 G. Delille, 'Consanguinité proche en Italie du XVIe au XIXe siècle', in Bonte (ed.), *Épouser au plus proche. Inceste, prohibitions et stratégies matrimoniales autour de la Méditerranée* (Paris: EHESS, 1994), pp. 323-67.
- 58 AHPM, Ventura Blanes y Rubio; 25-5-1790, sig. 2527, fols 40r-43v; AHPM, sig. 2984, fols 478r-505r; AHPM, Juan Mateo Atienza; 22-10-1798, sig. 4222, fols 1296r-1301r.
- 59 APSB, Libro compuesto de 364 hojas (17-7-1730/29-5-1735); fol. 20r; APSB, Libro compuesto de 230 hojas (29-5-1735/28-1-1738); fol. 183r de la Válgoma y Díaz-Varela, *Los Saavedra y los Fajardo*.
- 60 AHPM, Gregorio Buendía; 1788, sig. 2527, fols 22r-28v.
- 61 AHPM, Juan Mateo Atienza; 22-10-1798, sig. 4222, fols 1296r-1301v; Fontes Fuster, *Nuestra Heráldica*.
- 62 AHN, Secc. Órdenes Militares, Calatrava; 1700, E. 12003.
- 63 AHPM, Juan Mateo Atienza; 22-10-1798, sig. 4222, fols 1296r-1301v.
- 64 Author's own elaboration; AMJ, Fondo Soto Molina, L. 17, E. 306; AHPM, sig. 684, fols 243r-245v, 1613, escr. Damián de Alborno; APSB, Libro de Desposorios y Velaciones (3-5-1566/13-2-1612), 16-5-1605; APSNB, Libro de Desposorios y Velaciones (3-5-1566/13-2-1612), 16-5-1605, fol. 69v; APSNB, Libro 4º de Matrimonios (1651/1684), 10-2-1654, fol. 20r; APSNB., Libro 5º de matrimonios (desde 1662), 16-2-1670, fol. 38r; APSNB, Libro 5º de matrimonios (desde 1662), 25-9-1667, fol. 25v; AHPM, sig. 2527, fols 40r-43v, 25-5-1790, escr. Ventura Blanes; AHPM, sig. 2575, fols 22r-28v, 20-1-1788, escr. Gregorio Buendía; AHPM, sig. 4222, fols 1296r-1301v, 22-10-1798, escr. Juan Mateo Atienza; APSNM, Libro de Desposorios compuesto de 233 folios (21-11-1753/14-12-1779), 10-1-1771, fol. 174; D. de la Válgoma y Díaz-Valera, *Los Saavedra y los Fajardo*.
- 65 Author's own elaboration; APSNB, Libro 3º de bautismos (18-1-1586/1-5-1603), 1601, fol. 341; ARCG, Cabina 402, L. 3386, Pieza No. 23; ARCG, Cabina 402, L. 3410, Pieza No. 11, hojas 56; APSB, Libro 4º de bautismos (1-5-1603/28-2-1637), 1621, fol. 353v; APSNB, Libro 3º de desposorios y velaciones (1621-1639), fol. 86v; AHN, Secc. OOMM. (Montesa), L. 86, 1757; APSB, Libro 5º de bautismos (1-3-1637/11-3-1652), fols 219v-220r; APSNB., Libro 5º de bautismos (1-3-1637/11-3-1652), fol. 231r-v; APSNB, Libro 5º de matrimonios (desde 1662), 1670, fol. 38r; APSB, Libro 4º de bautismos (1-5-1603/28-2-1637), 1627, fol. 477v; APSNB, Libro 4º de matrimonios (1651-84), 1654, fol. 20r; APSB, Libro 6º de bautismos (12-3-1652/5-10-1665), 1655, fol. 67v; APSB, Libro 7º de bautismos (9-10-1665/3-8-1681), 1675, fol. 355v; AHN, Secc. Inq., L. 1403, no. 13, 1722. APSB, Libro de bautismos compuesto de 364 folios

- (17-7-1730/29-5-1735), 1730, fol. 20r; APSB, Libro de bautismos compuesto de 230 folios (29-5-1735/28-1-1738), 1737, fol. 183r; AHPM sig. 2575, fols 125r–126v., 24-7-1788, escr. Gregorio Buendía; APSN, Libro 8º de bautismos (1720–32), 27-5-1725; APSM, Libro de desposorios compuesto de 233 folios (21-11-1753/14-12-1779), 1771, fol. 174; de la Válgoma y Díaz-Valera, *Los Saavedra y los Fajardo*.
- 66 *Capitulaciones matrimoniales* (Cp.m.), the event that legally declares that two individuals are married.
- 67 Casey, *Family and Community*; B. Yun-Casalilla, 'Reading Sources throughout P. Bourdieu and Cyert and March. Aristocratic Patrimonies vs. Commercial Enterprises in Europe (c.1550–1650)', in F. Ammannati (ed.), *Dove va la Storia economica? Metodi e prospettive* (Florence: Florence University Press, 2011), pp. 325–37.
- 68 J. G. Peristiany (ed.), *Dote y matrimonio en los países mediterráneos* (Madrid: Centro de Investigaciones Sociológicas, 1987); M. Gómez Martín, 'Dote y herencia en la Vega de Granada. Alfarac en el siglo XVIII', in M. V. López Cordón and M. Carbonell Esteller (eds), *Historia de la mujer e Historia del matrimonio* (Murcia: Universidad de Murcia, 1997), pp. 183–90.
- 69 A. Peñafiel Ramón, 'Monjas, visiones y portentos en la España Moderna. Los relatos de confesores', *Contrastes. Revista de Historia Moderna*, 11 (1998–2000), 127–43.
- 70 A. Peñafiel Ramón, 'Costumbres, moral, fieles y clero en la Murcia del obispo Belluga', *Anales de Historia Contemporánea*, 21 (2005), 201–20. See the chapter about the dowry in M. Perez-Garcia, *Vicarious Consumers*; B. Yun-Casalilla and J. Torras (eds), *Consumo, condiciones de vida y comercialización: Cataluña, Castilla, siglos XVII–XIX* (Valladolid: Junta de Castilla y León, Consejería de Educación y Cultura, 1999).
- 71 Casey, *Family and Community*.
- 72 Author's own elaboration; AMJ, Fondo Soto Molina, L. 17, E. 306; AHPM, sig. 1033, fols 217r–222r, 1617, escr. Pedro Fernández Reolid; AHPM, sig. 363, 2-2-1538, fol. 643, escr. Pedro López; AHPM, sig. 2095, fol. 478, 22-6-1612, escr. Pedro Suárez; AHPM, sig. 2008, fol. 135, 29-5-1702, escr. Pedro Rubio; AHPM, sig. 2575, fols 13r–15v, 20-1-1788, escr. Gregorio Buendía; AHPM, sig. 2575, fols 16r. –19v, 20-1-1788, escr. Gregorio Buendía; AHPM, sig. 2575, fols 20r–21v, 20-1-1788, escr. Gregorio Buendía; AHPM, sig. 24-5-1788, escr. Gregorio Buendía. AHPM, sig. 2527, fols 7r–12v, 4-7-1775, escr. Ventura Blanes Rubio; AHPM, sig. 3339, fols 111r–118v, 22- 2-1762, escr. Alejandro López Mesas; AHPM, sig. 4961, fols 1340(bis)r–1350v, 5-10-1843, escr. Deogracias de la Parra Serrano.

- 73 Source: author's own elaboration; AHPM, sig. 684, fols 243r–245v, 1613, escr. Damián de Albornoz; AHPM, sig. 1293, fol. 544, 21-5-1631, escr. Melchor González de la Vega; Fontes Fuster, *Nuestra Heráldica*.
- 74 E. Bott, *Familia y red social. Roles, normas y relaciones externas en las familias urbanas corrientes* (Madrid: Taurus, 1990); M. Bertrand, 'Historia social y análisis micro histórico', *Cuadernos digitales: publicación electrónica en Historia, Archivística y Estudios Sociales*, 6/17 (2002), 1–17.
- 75 Gribauidi, 'Réseaux égocentrés et inscriptions sociales'.
- 76 M. Perez-Garcia, 'Consumption of Chinese goods in southwestern Europe: a multi-relational database and the vicarious consumption theory as alternative model to the industrious revolution (eighteenth century)', *Historical Methods: A Journal of Quantitative and Interdisciplinary History*, 52 (2019), 15–36; Perez-Garcia, 'New technologies applied to family history'; Perez-Garcia, 'Social Networks and Kinship'; J. Carvalho and R. Campos, 'Interpersonal networks'; C. Windler, 'Gérer des réseaux de relations: intermédiaires "indépendants" et agents de la noblesse seigneuriale', in J. L. Castellano and J. P. Dedieu (eds), *Réseaux, familles et pouvoirs dans le monde ibérique à la fin de l'Ancien Régime* (Paris: CNRS, 1998), pp. 147–68; J. M. Imízcoz Beunza, *Elites, poder y red social. Las elites del País Vasco y Navarra en la Edad Moderna* (Bilbao: Universidad del País Vasco, 1996); J. Pro, 'Socios, amigos y compadres: camarillas y redes personales en la sociedad liberal', in F. Chacón Jiménez and J. Hernández Franco (eds), *Familia, poderosos y oligarcas* (Murcia: Universidad de Murcia, 2001), pp. 153–73.
- 77 S. Cerutti, 'Normes et pratiques, ou la légitimité de leur opposition', in B. Lepetit (ed.), *Les formes de l'expérience: une autre histoire sociale* (Paris: Albin Michel, 1995), pp. 127–49; S. A. King, 'Multiple Source Record Linkage in a Rural Industrial Community, 1680–1820', *History and Computing*, 6 (1994), 133–42; J. Kok and K. Mandemakers, 'Life and Death of Singles in Dutch Cities, 1850–1940', *Journal of Urban History*, 21/1 (2016), 101–20; D. S. Reher, 'Family Ties in Western Europe: Persistent Contrasts', *Population and Development Review*, 24 (1998), 203–34; R. S. Shofield, 'Representativeness and Family Reconstitution', *Annales de Démographie Historique* (1972), 19–24.
- 78 B. Lepetit, 'Architecture, géographie, histoire: usages de l'échelle', *Genèses*, 13 (1993), 118–38; J. Revel, 'L'institution et le social', in B. Lepetit (ed.), *Les formes de l'expérience: une autre histoire sociale* (Paris: Albin Michel, 1995), pp. 63–84.
- 79 Perez-Garcia, *Vicarious Consumers*; Yun-Casallilla and J. Torras, *Consumo, condiciones de vida*; A. Peñafiel Ramón, *Aproximación al*

- estudio de los testamentos en el siglo XVIII: el murciano ante la muerte* (Murcia: Editora Regional, 1986).
- 80 AMM, Cofradía de Santiago de la Espada (1771–1816), Cabildos y Cuentas (1803); L. 3728.
- 81 Archivo Cofradía Nuestro Padre Jesús Nazareno (hereafter ACNPJN), Libro Becerro de los Cofrades de n° de misas; 1673.
- 82 A. M. Bernal and J. Lacroix, 'Aspects de la sociabilité andalouse. Les associations sévillanes, XIXe–XXe siècles', *Mélanges de la Casa de Velázquez*, 11 (1975), 435–507; R. Carrasco (ed.), *Solidarités et sociabilités en Espagne, XVIe–XXe siècles* (Paris: Annales Littéraires de l'Université de Besançon, 1991).
- 83 P. Carasa, 'La recuperación de la historia política y la prosopografía', in P. Carasa (ed.), *Elites: prosopografía contemporánea* (Valladolid: Universidad de Valladolid, 1994), pp. 41–51.
- 84 Author's own elaboration; APSB, Libro 3° de bautismos (18-1-1586/1-5-1603), 1601, fol. 341; APSB, Libro 4° de bautismos (1-5-1603/28-2-1637), 1610, fol. 154r; APSB, Libro 4° de bautismos (1-5-1603/28-2-1637), 1627, fol. 477v; APSB, Libro 4° de bautismos (1-5-1603/28-2-1637), 1621, fol. 353v; APSB, Libro 4° de bautismos (1-5-1603/28-2-1637), 1621, fol. 352v; APSB, Libro 5° de bautismos (1-3-1637/11-3-1652), 1648, fols 219v–220r; APSB, Libro 5° de bautismos (1-3-1637/11-3-1652), 1648, fol. 231r–v; APSB, Libro 7° de bautismos (9-10-1665/3-8-1681), 1675, fol. 355v; APSB, Libro 6° de bautismos (12-3-1652/5-10-1665), 1655, fol. 67v; APSB, Libro 10° de bautismos (21-11-1699/22-6-1709), 1706, fol. 327r; APSB, Libro compuesto de 230 hojas (29-5-1735/28-1-1738), 1737, fol. 183r; APSB, Libro 23° de bautismos (27-3-1757/13-8-1759), 1759, fol. 281v; APSB, Libro 42° de bautismos (1797–9), 1799, fol. 161r; APSB, Libro 2° de bautismos (1583–1607), 1591, fol. 50r; APSB, Libro de desposorios y velaciones (3-5-1566/13-2-1612), 1605, fol. 69v; APSB, Libro 3° de desposorios y velaciones (1621–39), 1635, fol. 86v; APSB, Libro 5° de matrimonios (desde 1662), 1667, fol. 25v; APSB, Libro 5° de matrimonios (desde 1662), 1670, fol. 83r; APSB, Libro 4° de matrimonios (1651–84), 1654, fol. 20r; APSB, Libro 8° de bautismos (1720–32), 1725, s.n.; APSM, Libro de bautismos y desposorios compuesto de 233 folios (21-11-1753/14-12-1779), 1771, fol. 174.
- 85 H. R. Ebaugh and M. Curry, 'Fictive kin as social capital in new immigrant communities', *Sociological Perspectives*, 43/2 (2000), 18–209; P. Gonzalbo Aizpuru, *Familia y orden colonial* (Mexico City: El Colegio de México, 1998); S. Chant and N. Craske, *Gender in Latin America* (New Brunswick: Rutgers University Press 2003); D. A. Brading, 'Bourbon Spain and its American Empire', in L. Bethel (ed.), *The Cambridge History of Latin America*, vol. 2: *Colonial Latin America*

- (Cambridge: Cambridge University Press, 1984), pp. 392–439; G. B. Paquette, 'Empire, Enlightenment and Regalism: New Directions in Eighteenth-century Spanish History', *European History Quarterly*, 35/1 (2005), 107–17; J. Adelman, *Republic of Capital: Buenos Aires and the Legal Transformation of the Atlantic World*, (Stanford, CA: Stanford University Press 1999); M. L. E. Wasserman, 'Círculos sociales, contextos normativos y crédito. Buenos Aires, siglo XVIII', *América Latina en Historia Económica*, 20/1 (January–April 2013), 35–77.
- 86 Author's own elaboration; APSB, Libro de bautismos compuesto de 364 folios (17-7-1730/29-5-1735), 1730, fol. 20r; Fontes Fuster, *Nuestra Heráldica*.
- 87 Author's own elaboration; AHPM, sig. 2674, fol. 83r–v, 1-6-1761, escr. José de Castilblanque; AHPM, sig. 2674, fols 296r–297v, 13-12-1761, escr. José de Castilblanque; AHPM, sig. 3141, fols 21r–22v, 29-1-1781, escr. Francisco Jiménez Ortega; AHPM, sig. 3246, fols 281r–282v., 5-5-1781, escr. Joaquín Jordán Fernández; AHPM, sig. 3143, fols 31r–58v, 12-5-1783, escr. Francisco Jiménez Ortega; AHPM, sig. 3143, fols 59r–61v, 15-5-1783, escr. Francisco Jiménez Ortega; AHPM, sig. 3141, fols 64r–65v, 16-3-1781, escr. Francisco Jiménez Ortega; AHPM, sig. 3141, fols 68r–70v, 20-3-1781, escr. Francisco Jiménez Ortega; AHPM, sig. 2674, fols 70r–71v, 14-4-1761, escr. José Leandro de Castilblanque; AHPM, sig. 3141, fols 56r–60v, 8-3-1781, escr. Francisco Jiménez Ortega; AHPM, sig. 2674, fols 94r–97v, 21-6-1761, escr. José Leandro de Castilblanque; AHPM, sig. 2575, fols 16r–19v, 20-1-1788, escr. Gregorio Buendía; AHPM, sig. 2575, fols 16r–19v, 20-1-1788, escr. Gregorio Buendía; AHPM, sig. 2575, fols 16r–19v, 20-1-1788, escr. Gregorio Buendía; AHPM, sig. 2527, fols 22r–28v, 20-1-1788, escr. Gregorio Buendía; AHPM, sig. 2575, fols 20r–21v, 20-1-1788, escr. Gregorio Buendía; AHPM, sig. 2575, fols 22r–28v, 20-1-1788, escr. Gregorio Buendía; AHPM, sig. 2575, fol. 70r–v., 17-4-1788, escr. Gregorio Buendía; AHPM, sig. 2575, fols 98r–99v, escr. Gregorio Buendía; AHPM, sig. 2575, fols 125r–126v, 24-5-1788, escr. Gregorio Buendía; AHPM, sig. 2575, fols 127r–128v, 24-V-1788, escr. Gregorio Buendía; AHPM, sig. 2575, fols 301r–307v, 15-10-1788, escr. Gregorio Buendía; AHPM, sig. 2805, fol. 132r–v., 11-9-1758, escr. Pedro Fajardo Calderón.
- 88 Author's own elaboration; protocols of the AHPM.
- 89 Author's own elaboration; AMM, sig. 3727 (I), s.n., 26-9-1759.
- 90 Mauss, *The Gift*.
- 91 Author's own elaboration; AMM, Cofradía Santiago de la Espada (1771–1816), L. 3728, Cabildos y Cuentas (1803); ACNPJN, Actas y Cabildos (24-8-1775/21-5-1786).
- 92 Source: author's own elaboration; protocols of the AHPM; AMM, Cofradía Santiago de la Espada (1771–1816), L. 3728, Cabildos y Cuentas (1803); ACNPJN, Actas y Cabildos (24-8-1775/21-5-1786).

- 93 AMM, Cofradía de Santiago de la Espada (1771–1816), Cabildos y Cuentas (1803); L. 3728. Documentally we do not count any reference stating that *juntas* and *cabildos* were prolonged in time.
- 94 ACNPJN, Libro de Juntas particulares de mayordomos (17-12-1796/10-5-1812).
- 95 J. Cruz, *Los notables de Madrid. Las bases sociales de la evolución liberal española* (Madrid: Alianza, 2000).
- 96 Author's own elaboration; AMM, Cofradía Santiago de la Espada, L. 3728, Cabildos y Cuentas (1803); ACNPJN, Libro de Juntas particulares de mayordomos (17-12-1796); ACNPJN, Libro de Acuerdos (1831/1844).
- 97 Author's own elaboration; AMM, Cofradía Santiago de la Espada, L. 3728, Cabildos y Cuentas (1803); ACNPJN, Libro de Juntas particulares de mayordomos (17-12-1796); ACNPJN., Libro de Acuerdos (1831/1844).

## Chapter 4

- 1 R. Ramos, B. V. Sousa and N. G. Monteiro, *História de Portugal* (Lisbon: Esfera dos Livros, 2009); M. S. Cunha, *A Casa de Bragança (1560–1640)*; *Práticas Senhoriais e Redes Clientelares* (Lisbon: Editorial Estampa, 2000); A. M. Hespanha, *Vísperas del Leviatán. Instituciones y poder político* (Portugal siglo XVII) (Madrid: Taurus, 1989); F. Olival, 'Economía de la merced y venalidad en Portugal (siglos XVII y XVIII)', in F. Andújar Castillo and M. M. Felices de la Fuente (eds), *El poder del dinero: ventas de cargos y honores en el Antiguo Régimen* (Madrid: Siglo XXI, 2011), pp. 345–57.
- 2 According to Bartolomé Yun-Casalilla the property systems were consolidated through *emphyteusis* by which 'land was conferred by estates through long-term lease agreements'. See Yun-Casalilla, *Iberian World Empires*, p. 16; Clavero, *Mayorazgo*.
- 3 Peñafiel Ramón and Hernández Franco, 'Parentesco, linaje y mayorazgo'; I. Atienza Hernández, *Aristocracia, poder y riqueza en la España Moderna. La Casa de Osuna, siglos XV–XIX* (Madrid: Siglo XXI, 1987); B. Yun-Casalilla, *Sobre la transición al capitalismo en Castilla. Economía y sociedad en Tierra de Campos* (Salamanca: Junta de Castilla y León, 1987); A. Abadía, *La enajenación de rentas señoriales en el Reino de Aragón* (Zaragoza: Institución Fernando el Católico, 1998); E. Soria Mesa, *El cambio inmóvil. Transformaciones y permanencias en una élite de poder, Córdoba, siglos XVI–XIX* (Córdoba: La Posada, 2000).
- 4 Cerutti, 'La construction des catégories sociales'.
- 5 Gerbet, *La nobleza en la Corona de Castilla*.
- 6 F. Devis Márquez, *Mayorazgo y cambio político: estudios sobre el mayorazgo de la casa de Arcos al final de la Edad Media* (Cádiz: Universidad de

- Cádiz, 1999); P. Ruíz García, *El Marquesado de Beniel y el Mayorazgo de Vélez Málaga* (Murcia: Ayuntamiento de Murcia, 1984); Atienza, 'La construcción de lo real', 41–59.
- 7 Maczak, 'From aristocratic household'; B. Yun-Casalilla, *Marte contra Minerva. El precio del imperio español, c. 1450–1600* (Barcelona: Crítica, 2004).
  - 8 Yun-Casalilla, *Marte contra Minerva*; M. García Fernández, 'Herederos y beneficiarios. Igualdad hereditaria o heredar lo mismo', in A. Irigoyen López and A. L. Pérez Ortíz (eds), *Familia, transmisión y perpetuación (siglos XVI–XIX)* (Murcia: Universidad de Murcia, 2002), pp. 135–48.
  - 9 Gerbet, *La nobleza en la Corona de Castilla*.
  - 10 Yun-Casalilla, *Sobre la transición al capitalismo*; M. Perez-Garcia, 'Mayorazgo y poder en Baza: el pleito de tenuta entre los Muñoz y los Galiano (siglo XVIII)', *Péndulo. Revista Miscelánea de difusión cultural*, 6 (2005), 179–88.
  - 11 Clavero, *Mayorazgo*.
  - 12 Casey, *Family and Community*; Delille, 'La historia de la familia'; Chacón Jiménez, 'Hacia una nueva definición'; Bestard, *Parentesco y modernidad*; L. Ferrer i Alós, 'Estrategias familiares y formas jurídicas de transmisión de la propiedad y el status social', *Boletín de la Asociación de Demografía Histórica*, 10/3 (1992), 9–14.
  - 13 Pérez Picazo, *El mayorazgo*; Clavero, *Mayorazgo*.
  - 14 F. Brumont, *Paysans de Vieille-Castille aux XVIe et XVIIe siècles* (Madrid: Casa de Velázquez, 1993); R. Kagan, *Pleitos y pleiteantes en Castilla* (Salamanca: Junta de Castilla y León, 1991); A. Moreno Almárcegui, *El origen histórico de un sistema de heredero único. El prepirineo navarro (1540–1739)* (Navarra: Universidad de Navarra, 1999); N. G. Monteiro, '17th and 18th century Portuguese Nobilities in the European Context: A historiographical overview', *e-Journal of Portuguese History*, 1 (2003), 1–15; J. Hernández Franco, 'El mayorazgo Moctezuma: reflexiones sobre un proceso de movilidad vertical con alternancias (1509–1807)', *Estudis: Revista de historia moderna*, 32 (2006), 215–36.
  - 15 Atienza Hernández, *Aristocracia, poder y riqueza*, p.113; Yun-Casalilla, *Marte contra Minerva*; Casey, *Family and Community*.
  - 16 AMJ, Fondo Soto Molina, L. 17, E. 306.
  - 17 G. Lemeunier, 'El régimen señorial en la sociedad murciana de la época moderna', *Áreas*, 10 (1989), 113–15; G. Lemeunier, *Los señoríos murcianos, siglo XVI–XVIII* (Murcia: Universidad de Murcia, 1998).
  - 18 J. F. Jiménez Alcázar, *Agua y poder en Lorca durante la Baja Edad Media* (Murcia: Universidad de Murcia, 1996).
  - 19 F. Chacón Jiménez and J. Martínez López, 'Aproximación al estudio de la Historia Social de la población de Lorca y su comarca durante

- los siglos XVI y XVII', in F. Chacón Jiménez, J. A. Mula Gómez and F. Calvo García Tornel (eds), *Lorca. Pasado y Presente. Aportaciones a la Historia de la Región de Murcia*, vol. I: *La formación de una comarca histórica: tierras, pueblos y culturas* (Lorca: Ayuntamiento de Lorca-CAM, 1990), 251–73; F. Chacón Jiménez, 'Los señores del agua. Estudio de un proceso de polarización social en Lorca. Siglos XV–XVII', *Agua, riegos y modos de vida en Lorca y su comarca* (Lorca: Ayuntamiento de Lorca, 1986), pp. 17–50.
- 20 AMJ, Fondo Soto Molina, L. 17, E. 306; G. Lemeunier, 'Propiedad y economía agraria en Lorca (siglos XVI–XVIII)', in F. Chacón Jiménez, J. A. Mula Gómez and F. Calvo García Tornel (eds), *Lorca. Pasado y Presente. Aportaciones a la Historia de la Región de Murcia*, vol. I: *La formación de una comarca histórica: tierras, pueblos y culturas* (Lorca: Ayuntamiento de Lorca-CAM, 1990), pp. 275–83.
- 21 Delille, *Famille et propriété*.
- 22 Archivo Histórico Provincial de Murcia (hereafter AHPM), Martín Faura; 15-4-1544, sig. 617, fol. 909.
- 23 AHPM, Pedro Suárez; 30-5-1617, sig. 2097, fol. 436.
- 24 G. Lemeunier and M. T. Pérez Picazo, 'Cens emfitèutic i colonització agrícola a Murcia (1450–1900)', *Estudis d'Historia Agraria*, 7 (1988), 51–7; P. Ruíz Torres, *Señores y propietarios. Cambio social en el Sur del País valenciano: 1650–1850* (Valencia: Institución Alfonso el Magnánimo, 1981); P. Ruíz Torres, 'Los señoríos valencianos en la crisis del Antiguo Régimen: una revisión historiográfica', *Estudis d'Historia Contemporànea del País Valencià*, 5 (1984), 23–81; Yun-Casalilla, *Iberian World Empires*, p. 21.
- 25 Archivo Real Chancillería de Granada (hereafter ARCG); Cabina 402, L. 3392, Pieza No. 5.
- 26 ARCG; Cabina 402, L. 3392, Pieza No. 5.
- 27 AHPM, Salvador Fernández; 24-10-1596, sig. 206, fol. 896.
- 28 AHPM, Pedro López; 2-2-1538, sig. 316, fol. 643; AHN, Secc. Consejos; L. 4953.
- 29 Jiménez Alcázar, *Un concejo de Castilla*.
- 30 J. F. Jiménez Alcázar and F. López Bermúdez, *Sequía, aridez y desertificación en Murcia* (Murcia: Academia Alfonso X el Sabio, 1985).
- 31 ARCG, Cabina 402, L. 3410, Pieza No. 11, hojas 56.
- 32 ARCG, Cabina 402, L. 3392, Pieza No. 5.
- 33 ARCG, Cabina 402, L. 3392, Pieza No. 5.
- 34 ARCG, Cabina 402, L. 3410, Pieza No. 11, hojas 56.
- 35 O. Brunner, *Terra e potere: strutture pre-statali e pre-moderne nella storia costituzionale dell'Austria medievale* (Varese: Giuffrè, 1983); E. Soria Mesa, *Señores y oligarcas: los señoríos del Reino de Granada en la Edad Moderna* (Granada: Universidad de Granada, 1997); P. Malanima, *La fine del primato. Crisi e riconversione nell'Italia del Seicento* (Milan:



- Mondadori, 1998); L. Prados de la Escosura and C. Álvarez-Nogal 'The Decline of Spain (1500–1850): Conjectural Estimates', *European Review of Economic History*, 11 (2007), 319–66.
- 36 ARCG; Cabina 402, L. 3386, Pieza No. 23.
- 37 AHPM, Juan Gómez; 7-3-1577, sig. 7055, fol. 483; AHPM, Martín Alonso; 15-11-1557, sig. 7033, fol. 332.
- 38 ARCG, Cabina 402, L. 3386, Pieza No. 23.
- 39 AHPM, Martín Alonso; 15-11-1557, sig. 7033, fol. 332.
- 40 AHPM, Martín Alonso; 1-9-1563, sig. 7033, fol. 332.
- 41 E. Soria Mesa, 'Las capellanías en la Castilla Moderna: familia y ascenso social', in A. Irigoyen López and A. L. Pérez Ortiz (eds), *Familia, transmisión y perpetuación (siglos XVI–XIX)* (Murcia: Universidad de Murcia, 2002), pp. 135–48; R. Sánchez González, 'Las capellanías en el Antiguo Régimen (siglos XVI–XIX): estudio de la zona de La Sagra', *Anales Toledanos*, 23 (1986), 101–47.
- 42 ARCG, Cabina 402, L. 3386, Pieza No. 23.
- 43 ARCG, Cabina 402, L. 3386, Pieza No. 23.
- 44 AHPM, Juan Gómez; 7-3-1577, sig. 7055, fol. 483.
- 45 AHPM, Juan Gómez; 7-3-1577, sig. 7055, fol. 483; ARCG, Cabina 402, L. 3386, Pieza No. 23.
- 46 ARCG, Cabina 402, L. 3386, Pieza No. 23.
- 47 AHPM, Deogracias de la Parra Serrano; 14-6-1844, sig. 4961, fols 1312r–1339v.
- 48 Archivo Municipal de Murcia (hereafter AMM); L. 2354.
- 49 AHN, Secc. Consejos; L. 37749; AHN, Secc. Consejos; L. 37804.
- 50 Casey, *Family and Community*.
- 51 ARCG, Cabina 402, L. 3410, Pieza No. 11, hojas 56; ARCG, Cabina 402, L. 3386, Pieza No. 23.
- 52 AHPM, Francisco Juto de Oces; 3-7-1627, sig. 1460, fols 697r–703v; ARCG, Cabina 402, L. 3410, Pieza No. 11, hojas 56; AHPM, Francisco Juto de Oces; 25-1-1622, sig. 1450, fols 170r–177v.
- 53 AHPM, Francisco Juto de Oces; 25-1-1622, sig. 1450, fols 170r–177v; AHPM, Francisco Juto de Oces; 3-7-1627, sig. 1460, fols 697r–703v; ARCG, Cabina 402, L. 3410, Pieza No. 11, hojas 56.
- 54 AHPM, Francisco Juto de Oces; 25-1-1622, sig. 1450, fols 170r–177v; AHPM, Francisco Juto de Oces; 3-7-1627, sig. 1460, fols 697r–703v; ARCG, Cabina 402, L. 3410, Pieza No. 11, hojas 56.
- 55 AHPM, Gregorio Buendía; 20-1-1788, sig. 2575, fols 22r–28v.
- 56 AHPM, Pedro López; 2-2-1538, sig. 363, fol. 643; AHPM, Juan de Jumilla; 12-1-1558, sig. 316, fol. 822; AHPM, Salvador Fernández; 13-3-1593, sig. 202, fol. 1090.
- 57 AHN, Secc. Consejos; L. 4953.
- 58 AHN, Secc. Consejos; L. 4953.
- 59 AHPM, Salvador Fernández; 13-3-1593, sig. 202, fol. 1090.

- 60 AHN, Secc. Consejos; L. 4953.
- 61 AHN, Secc. Consejos; L. 4953.
- 62 M. Hernández, 'Sobre familias, relaciones y estrategias familiares en una elite ciudadana (los regidores de Madrid, siglos XVI–XVIII)', in F. Chacón Jiménez and J. Hernández Franco (eds), *Familia, poderosos y oligarquías* (Murcia: Universidad de Murcia, 2001), pp. 61–80; M. Hernández, *A la sombra de la Corona. Poder local y oligarquía urbana (Madrid 1605–1808)* (Madrid: Siglo XXI, 1995).
- 63 For definitions of *juros* and *censo*s see Yun-Casalilla, *Iberian World Empires*, p. 169. For *almojarifazgo* see Yun-Casalilla, *Marte contra Minerva*, pp. 147–51. For *alacabalas* see Yun-Casalilla, *Iberian World Empires*, p. 16.
- 64 AHN, Secc. Consejos; L. 4953.
- 65 AHPM, Pedro Suárez; 22-6-1612, sig. 2095, fol. 478; Archivo Parroquial de Santa Justa y Rufina (hereafter APSJR), Libro de visitas pastorales (1723–38); sig. 156.
- 66 AHN, Secc. Consejos; L. 4953.
- 67 AHN, Secc. Consejos; sig. 4953.
- 68 AHN, Secc. Consejos; L. 4953.
- 69 AHPM, Mateo Suárez; 9-3-1629, sig. 7352, fol. 516.
- 70 AHN, Secc. Consejos; L. 4953.
- 71 AHN, Secc. Consejos; L. 4953.
- 72 AHPM, Melchor González de la Vega; 21-5-1631, sig. 1293, fol. 544.
- 73 AHPM, Melchor González de la Vega; 21-5-1631, sig. 1293, fol. 544.
- 74 AHN, Secc. Consejos; L. 4953.
- 75 AHN, Secc. Consejos; L. 4953; AHPM, Melchor González de la Vega; 21-5-1631, sig. 1293, fol. 544.
- 76 AHPM, Cristóbal Vilchez Ruíz; 16-3-1655, sig. 2186.
- 77 AHPM, Pedro Ferrer; 31-10-1642, sig. 1149, fol. 626.
- 78 AHPM, Pedro Rubio; 29-5-1702, sig. 2008, fol. 135.
- 79 AHN, Secc. Consejos; L. 4953.
- 80 AHPM, Pedro Rubio; 29-5-1702, sig. 2008, fol. 135.
- 81 AHN, Secc. Consejos; L. 4953.
- 82 AHPM, José Bastida; 1-11-1718, sig. 2478, fol. 980.
- 83 AHN, Secc. Consejos; L. 4953.
- 84 AHN, Secc. Consejos; L. 4953.
- 85 AHPM, José Bastida; 1-11-1718, sig. 2478, fol. 980.
- 86 AHN, Secc. Consejos; L. 4953.
- 87 AHN, Secc. Consejos; L. 4953.
- 88 AHN, Secc. Consejos; L. 4953.
- 89 AHN, Secc. Consejos; L. 4953.
- 90 Clavero, *Mayorazgo*.
- 91 AHPM, Jacinto Ferrer; 17-1-1641, sig. 1173, fol. 554; AHN, Secc. Consejos; L. 4953.
- 92 AHPM, Francisco Jiménez Ortega; 12-5-1783, sig. 3143, fols 31r–58v.

- 93 AHPM, Jacinto Ferrer; 17-1-1641, sig. 1173, fol. 554.
- 94 AHPM, Gregorio Buendía; 20-1-1788, sig. 2575, fols 16r–19v.
- 95 Gerbet, *La nobleza en la Corona de Castilla*.
- 96 J. P. Dedieu, 'Familias, mayorazgos, redes de poder. Extremadura, siglos XV–XVIII', in J. L. Castellano and J. P. Dedieu (eds), *Réseaux, familles et pouvoirs dans le monde ibérique à la fin de l'Ancien Régime* (Paris: CNRS, 1998), pp. 107–18.
- 97 ARCG, Cabina 402, L. 3360, Pieza No. 24; ARCG, Cabina 402, L. 3386, Pieza No. 23.
- 98 Clavero, *Mayorazgo*.
- 99 Dedieu, 'Familias, mayorazgos, redes de poder'.
- 100 AHN, Secc. Consejos; L. 4953.
- 101 AHN, Secc. Consejos; L. 4953.
- 102 AHN, Secc. Consejos; L. 4953; AHN, Secc. Consejos; L. 4953.
- 103 ARCG, Cabina 402, L. 3418, Pieza No. 5.
- 104 ARCG, Cabina 402, L. 3410, Pieza No. 11, hojas 56.
- 105 ARCG, Cabina 402, L. 3418, Pieza No. 5.
- 106 ARCG; Cabina 402, L. 3419, Pieza No. 12.
- 107 AHN, Secc. Consejos; 1709, L. 37630, Ejecutoria No. 1068.
- 108 ARCG, Cabina 402, L. 3392, Pieza No. 5.
- 109 AHPM, Deogracias de la Parra Serrano; 1823, sig. 4922, T. 2, fols 1304r–1337v.
- 110 ARCG, Cabina 402, L. 3406, Pieza No. 17.
- 111 ARCG; Cabina 402, L. 3384, Pieza No 27.
- 112 ARCG, Cabina 402, L. 3348, Pieza No. 27; ARCG, Cabina 402, L. 3386, Pieza No. 23; AHPM, Alejandro López de Mesas; 22-2-1762, sig. 3339, fols 111r–118v.
- 113 Pérez Picazo, *El mayorazgo*; AHPM, Deogracias Serrano de la Parra; 14-6-1844, sig. 4961, fols 1249v–1339v.
- 114 ARCG, Cabina 402, L. 3406, Pieza No. 17.
- 115 AHPM, Deogracias de la Parra Serrano; sig. 4922, T. 2, fols 1304r–1337v.
- 116 ARCG, Cabina 402, L. 3348, Pieza No. 27; ARCG; Cabina 402, L. 3406, Pieza No. 17; ARCG, Cabina 402, L. 3386, Pieza No. 23.
- 117 AHPM, Deogracias Serrano de la Parra; 14-6-1844, sig. 4961, fols 1249v–1339v.
- 118 ARCG, Cabina 402, L. 3418, Pieza No. 5; ARCG, Cabina 402, L. 3419, Pieza No. 12; ARCG, Cabina 402, L. 3384, Pieza No. 27; ARCG, Cabina 402, L. 3386, Pieza No. 23; ARCG, Cabina 402, L. 3360, Pieza No. 24; ARCG, Cabina 402, L. 3406, Pieza No. 17; ARCG, L. 3392, Pieza No. 5; ARCG, Cabina 402, L. 3410, Pieza No. 11, hojas 56; AHN, Secc. Consejos; 1709, L. 37630, Ejecutoria No. 1068.
- 119 J. P. Dedieu, 'Familias, mayorazgos, redes de poder'.

- 120 AHPM, Deogracias Serrano de la Parra; 5-10-1843, sig. 4961, fols 1340(bis)r-1350v.
- 121 AHPM, Deogracias de la Parra Serrano; 5-10-1843, sig. 4961, fols 1340(bis)r-1350v.
- 122 J. S. Pérez Garzón, 'El fin de la sociedad estamental', *Torre de los Lujanes*, 28 (1994), 119-32.

## Conclusions

- 1 Casey, *Family and Community*, 2007.

# Appendix

---

Figure 2.1

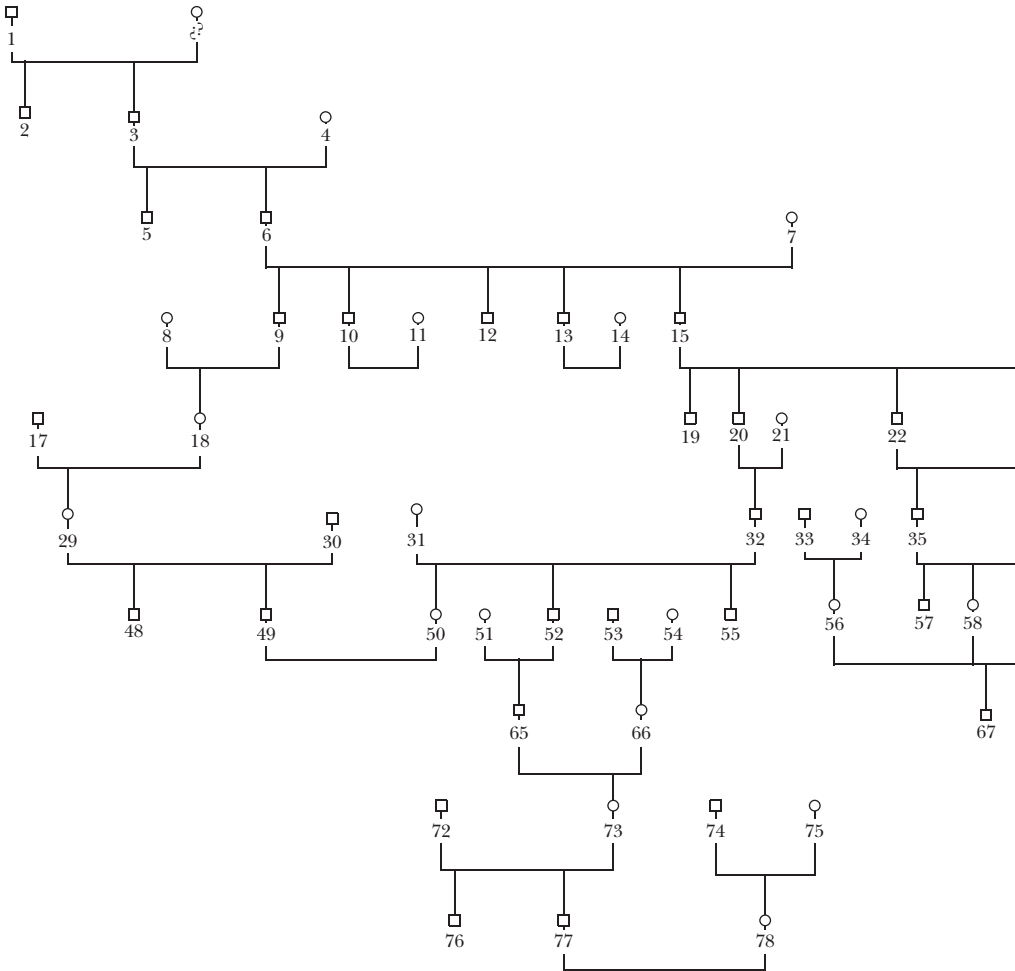

- |                                  |                                 |  |
|----------------------------------|---------------------------------|--|
| 1 LUIS ALVAREZ DE PAZ            | 29 MARIA DE AYONTE              | 58 ISABEL MARIA PAZ DE LA BARRERA                        |
| 2 PEDRO DE PAZ                   | 30 JUAN TINOCO DE CASTILLA      | 59 GONZALO SANCHEZ DE BOLAÑOS MARAVER *                  |
| 3 FRANCISCO DE PAZ               | 31 ANA DE BOLAÑOS Y PAZ *       | 60 INES DE PAZ* MARMOLEJO                                |
| 4 MARIA ALONSO                   | 32 ALONSO ANTONIO DE PAZ        | 61 MARIA DE PAZ MARMOLEJO Marquesa de Barros             |
| 5 ANTONIO DE PAZ                 | 33 IGNACIO DE SANTANDER Y LIAÑO | 62 JUAN DE BOLAÑOS                                       |
| 6 SANCHO DE PAZ                  | 34 ISABEL DE BARGAS MACHUCA     | 63 ANA DE BOLAÑOS Y PAZ *                                |
| 7 MARIA DE HINOSTROSA            | 35 ANTONIO DE PAZ               | 64 GONZALO SANCHEZ DE BOLAÑOS MARAVER *                  |
| 8 ISABEL VAZQUEZ                 | 36 ISABEL PAZ DE LA BARRERA     | 65 FRANCISCO ALONSO DE PAZ Y CASTILLA                    |
| 9 HERNANDO DE PAZ                | 37 FRANCISCA DE PAZ             | 66 ANA POLIZENA ESPINOSA Y PAZ                           |
| 10 RODRIGO DE PAZ                | 38 RODRIGO MARMOLEJO            | 67 MIGUEL DE BOLAÑOS PAZ                                 |
| 11 ISABEL MARTINEZ "La Chamorra" | 39 BEATRIZ DE ASUNCION monja    | 68 GONZALO SANCHEZ DE BOLAÑOS                            |
| 12 FRANCISCO DE PAZ              | 40 MARIA DE S. ANDRES monja     | 69 JUAN ANTONIO SANCHEZ DE BOLAÑOS                       |
| 13 JUAN DE PAZ                   | 41 DIEGO DE PAZ MORALES         | 70 MARCOS DE BOLAÑOS                                     |
| 14 CATALINA SANCHEZ              | 42 CRISTOBAL DE BOLAÑOS         | 71 INES DE BUSTOS  |
| 15 ANTONIO DE PAZ                | 43 MIGUEL SANCHEZ DE BOLAÑOS    | 72 BALTASAR FONTES MELGAREJO II Marqués de Torre Pacheco |
| 16 ISABEL RODRIGUEZ "La holgada" | 44 BEATRIZ MARAVER MONTOYA      | 73 NICOLASA DE PAZ Y CASTILLA                            |
| 17 NANO DE AYONTE                | 45 ARIAS MARAVER                | 74 JOAQUIN RIQUELME Y TOGORES                            |
| 18 ISABEL GARCIA DE PAZ          | 46 ISABEL MARAVER monja         | 75 ANA MARIA BUENDIA Y FONTES                            |
| 19 FRANCISCO RODRIGUEZ DE PAZ    | 47 MARIA DE MONTOYA monja       | 76 VENTURA FONTES PAZ                                    |
| 20 ALONSO DE PAZ                 | 48 FRANCISCO DE CASTILLA TINOCO | 77 ANTONIO FONTES PAZ                                    |
| 21 MARIA DE TORRES               | 49 JUAN TINOCO                  | 78 FRANCISCA RIQUELME Y BUENDIA                          |
| 22 DIEGO DE PAZ                  | 50 MARIA DE PAZ                 |  |
| 23 JUAN DE PAZ                   | 51 MARIANA DE CASTILLA          |  |
| 24 HERNANDO DE PAZ               | 52 FRANCISCO ALONSO DE PAZ      |  |
| 25 INES DE MORALES               | 53 AGUSTIN DE ESPINOSA          |  |
| 26 ALVARO DE PAZ                 | 54 INES DE PAZ* MARMOLEJO       |  |
| 27 BEATRIZ DE PAZ                | 55 ALONSO DE PAZ                |  |
| 28 HERNANDO SANCHEZ MARAVER      | 56 ANTONIA SANTANDER Y LIAÑO    |  |
|                                  | 57 ANTONIO DE PAZ               |  |

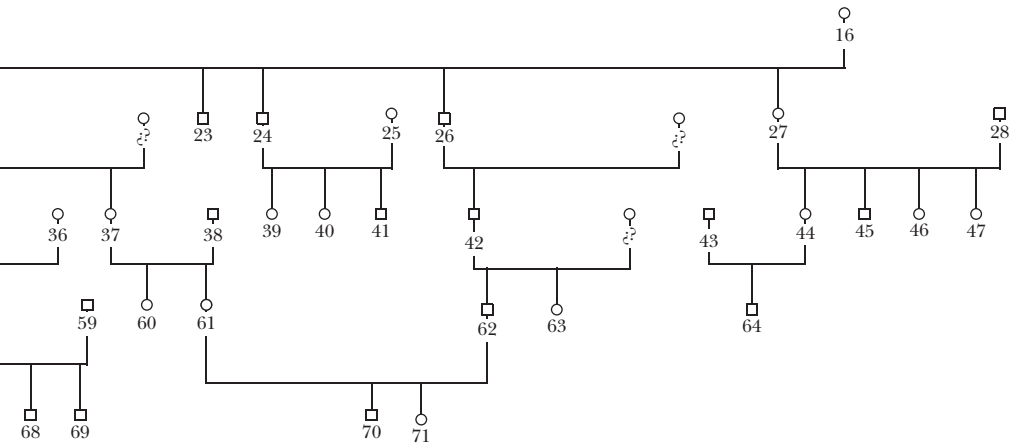
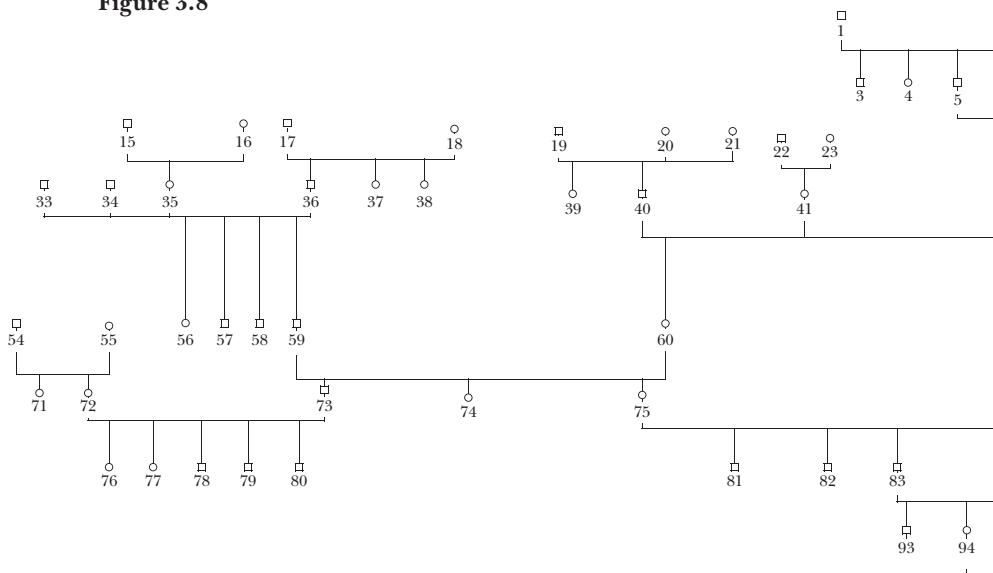
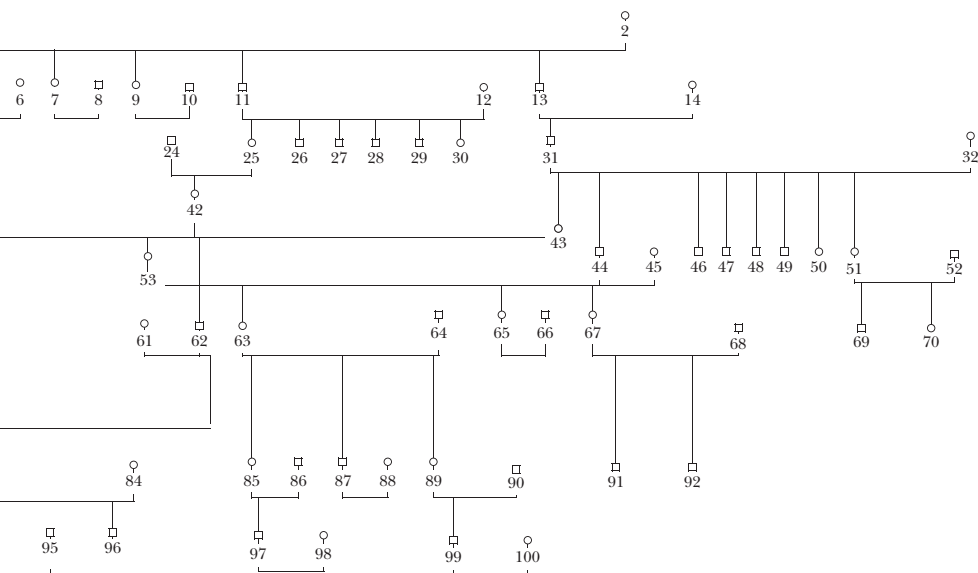

Figure 3.8



- |   |   |
|---|---|
| 1 BALTASAR FONTES Y AVILES  | 26 JOSE MARIA FONTES BARNUEVO                               |
| 2 ISABEL FRANCISCA CARRILLO MARIN                                     | 27 FRANCISCO FONTES BARNUEVO                                |
| 3 BALTASAR FONTES DE ALBORNOZ Y CARRILLO                              | 28 BALTASAR FONTES BARNUEVO                                 |
| 4 ISABEL FONTES DE ALBORNOZ Y CARRILLO                                | 29 JOSEFA FONTES BARNUEVO                                   |
| 5 JOSE MARIA FONTES DE ALBORNOZ Y CARRILLO                            | 30 MARIA FONTES BARNUEVO                                    |
| 6 MARIA BUENDIA   | 31 BALTASAR FONTES MELGAREJO<br>II Marques de Torre Pacheco |
| 7 TERESA FONTES DE ALBORNOZ Y CARRILLO                                | 32 NICOLASA MARIA DE PAZ Y CASTILLA                         |
| 8 JOSE BUENDIA  | 33 JUAN DE SANDOVAL Y LISON                                 |
| 9 CATALINA FONTES DE ALBORNOZ Y CARRILLO                              | 34 JOSE ROCAFULL PUXMARIN Y FAJARDO I Marques de Albudeite  |
| 10 FRANCISCO MELGAREJO  | 35 MARIA GERONIMA ORTEGA Y ZAMBRANA                         |
| 11 AMBROSIO FONTES DE ALBORNOZ Y CARRILLO                             | 36 ANTONIO FONTES CARRILLO BIENVENGUD Y ARCE                |
| 12 MARGARITA BARNUEVO   | 37 PATRICIA FONTES BIENVENGUD                               |
| 13 MACIAS FONTES DE ALBORNOZ Y CARRILLO<br>I Marques de Torre Pacheco | 38 CLAUDIA FONTES BIENVENGUD                                |
| 14 ANA CEFERINA MELGAEJO Y GALTERO                                    | 39 CONSTANZA RIQUELME Y TOGORES                             |
| 15 GABRIEL ORTEGA GUERRERO<br>Marques de Valdeguerrero                | 40 JOAQUIN RIQUELME Y TOGORES                               |
| 16 MARIA JOSEFA DE SANDOVAL Y ZAMBRANA                                | 41 MANUELA DE ROBLES Y MOLINA                               |
| 17 PEDRO FONTES CARRILLO  | 42 ANA MARIA BUENDIA Y FONTES                               |
| 18 LUISA BIENVENGUD LADRON DE GUEVARA                                 | 43 ANTONIA FONTES PAZ                                       |
| 19 FRANCISCO DE PAULA ROBLES Y RIQUELME                               | 44 ANTONIO FONTES PAZ III Marques de Torre Pacheco          |
| 20 ISABEL DE TOGORES Y ROBLES   | 45 ISABEL MARIA RODRIGUEZ DE NAVARRA Y MERGELINA            |
| 21 IRENE GALTERO  | 46 VENTURA FONTES PAZ                                       |
| 22 ALVARO DE ROBLES   | 47 PASCUAL FONTES PAZ                                       |
| 23 CATALINA DE MOLINA   | 48 BALTASAR FONTES PAZ                                      |
| 24 GREGORIO BUENDIA   | 49 JUAN FONTES PAZ  |
| 25 ISABEL MANUELA FONTES BARNUEVO                                     | 50 MAGDALENA FONTES PAZ                                     |



- |   |   |
|---|---|
| 51 MANUELA FONTES PAZ   | 76 JUANA FONTES ABAD  |
| 52 JOSE AVELLANEDA  | 77 ANA FONTES ABAD  |
| 53 FRANCISCA RIQUELME Y BUENDIA                                 | 78 ESTANISLAO FONTES ABAD                                     |
| 54 SANCHO JOSE ABAD SANDOVAL                                    | 79 JOSE FONTES ABAD   |
| 55 ANA MARIA DE ULLOA OLMEDILLA                                 | 80 ANTONIO FONTES ABAD  |
| 56 ISABEL FONTES ORTEGA   | 81 JOAQUIN RIQUELME Y FONTES                                  |
| 57 RODRIGO FONTES ORTEGA  | 82 JUAN RIQUELME Y FONTES                                     |
| 58 DIEGO FONTES ORTEGA  | 83 ANTONIO RIQUELME Y FONTES Señor de Guadalupe               |
| 59 ANTONIO FONTES ORTEGA Y ZAMBRANA                             | 84 JOSEFA ARCE Y FLORES                                       |
| 60 LUISA RIQUELME ROBLES Y SERRANO                              | 85 CONCEPCION FONTES FERNANDEZ DE LA REGUERA                  |
| 61 ISABEL MARIA ABAD Y ULLOA*                                   | 86 JOSE MUSSO PEREZ Y VALIENTE                                |
| 62 JESUALDO RIQUELME Y FONTES<br>Señor de Guadalupe             | 87 JOAQUIN FONTES FERNANDEZ DE LA REGUERA                     |
| 63 JOAQUIN FONTES RIQUELME                                      | 88 CONCEPCION ALVAREZ TOLEDO                                  |
| 64 MARIA DE LOS DOLORES FERNANDEZ DE LA<br>REGUERA Y SANCHE     | 89 JOSEFA FONTES FERNANDEZ DE LA REGUERA                      |
| 65 SEGUNDA FONTES RIQUELME                                      | 90 JOSE ZARANDONA Y PRIETO                                    |
| 66 JUAN JOSE FERNANDEZ DE LA REGUERA Y SANCHE                   | 91 JOAQUIN RIQUELME SALAFRANCA Y FONTES                       |
| 67 MARIA DE LOS REMEDIOS FONTES RIQUELME                        | 92 JOSE RIQUELME SALAFRANCA Y FONTES<br>II Marques de Pinares |
| 68 BERNARDO RIQUELME SALAFRANCA Y ROCHA<br>I Marques de Pinares | 93 ANTONIO RIQUELME Y ARCE Marques de las Almenas             |
| 69 MIGUEL AVELLANEDA Y FONTES                                   | 94 TERESA RIQUELME Y ARCE Marquesa de las Almenas             |
| 70 Sor ASUNCION AVELLANEDA Y FONTES                             | 95 RAFAEL DE BUSTOS Y CASTILLA Marques de Corvera             |
| 71 ISABEL MARIA ABAD Y ULLOA*                                   | 96 JOSE RIQUELME Y ARCE                                       |
| 72 FELIPA MARIA ABAD Y ULLOA                                    | 97 JOSE MUSSO Y FONTES  |
| 73 FRANCISCO DE BORJA FONTES Y RIQUELME                         | 98 MANUELA MORENO Y ROCAFULL                                  |
| 74 MARIA FONTES RIQUELME  | 99 LUIS ZARANDONA Y FONTES                                    |
| 75 MARIA DE LA CONCEPCION FONTES RIQUELME                       | 100 PILAR SANDOVAL Y MELGAREJO                                |



Figure 4.3

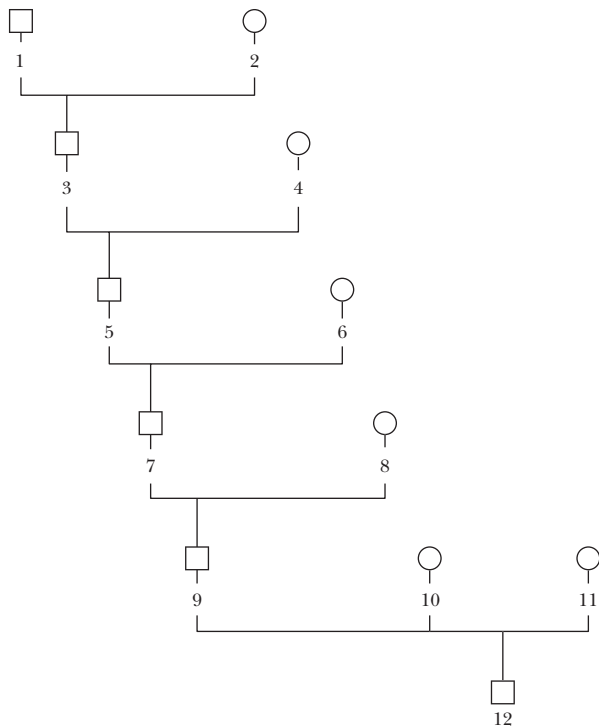

1 Diego Riquelme  
(first lord of Santo Angel)

2 Beatriz de Bombau

3 Pedro Riquelme  
(second lord of Santo Angel)

4 Constanza de Arroniz

5 Cristobal Riquelme de Arroniz  
(third lord of Santo Angel)

6 Nofra Riquelme de Albornoz

7 Nofre Riquelme de Arroniz  
(fourth lord of Santo Angel)

8 Blanca de Aviles

9 Luis Riquelme de Aviles  
(fifth lord of Santo Angel)

10 Juana de Junteron

11 Petronila de Roda y Perea

12 Cristobal Riquelme de Albornoz  
(sixth lord of Santo Angel)

Figure 4.9

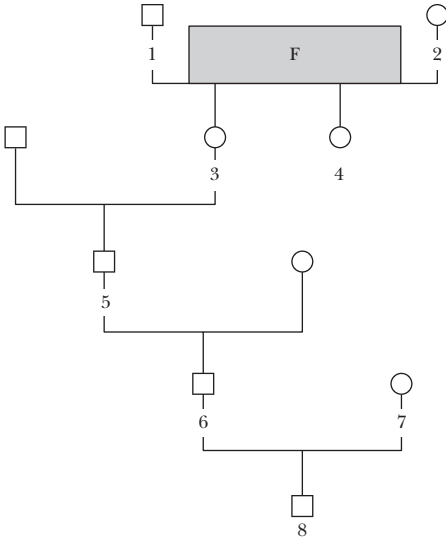

F Founders of the mayorazgo

- 1 Don Juan de Junco
- 2 Doña Francisca Ballester
- 3 Lucia de Junco
- 4 Francisca de Junco
- 5 Pablo Fulgencio de Almela y Junco
- 6 Cristobal Riquelme Muñoz de Robles
- 7 Francisca Almela y Tomas
- 8 Cristobal Riquelme Muñoz de Robles

Figure 4.11

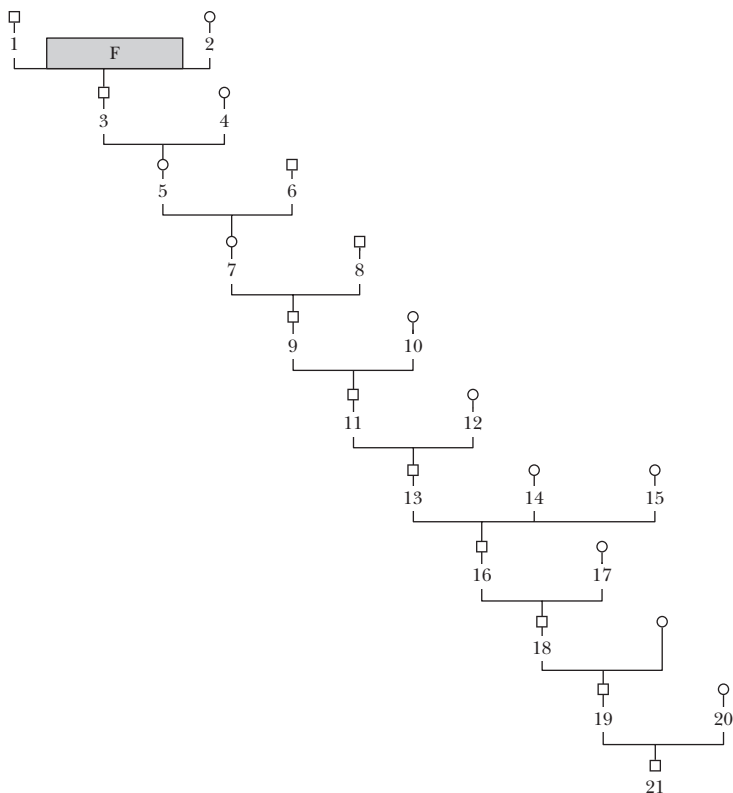

F Founders of the mayorazgo

1 Diego Riquelme de Aviles

2 Constanza de Bernal

3 Gonzalo Rodriguez de Aviles

4 Isabel Fontes

5 Constanza de Aviles y Fontes

6 Macias Coque Riquelme

7 Petronila Riquelme de Aviles

8 Baltasar Fontes Riquelme

9 Macias Fontes Riquelme  
(lord of Alguazas)

10 Catalina de Aviles y Fajardo

11 Baltasar Fontes y Aviles

12 Isabel Francisca Carrillo Marin

13 Macias Fontes Carrillo  
(first marquis of Torre Pacheco)

14 Ana Ceferina Melgarejo y Galtero

15 Josefa Mariana Perez Evia de Merlos

16 Baltasar Fontes Melgarejo (second  
marquis of Torre Pacheco)

17 Nicolasa Maria de Paz y Castilla

18 Baltasar Fontes Paz

19 Antonio Fontes Paz (third marquis  
of Torre Pacheco)

20 Francisca Riquelme y Buendia

21 Joaquin Fontes Riquelme  
(fourth marquis of Torre Pacheco)

Figure 4.12

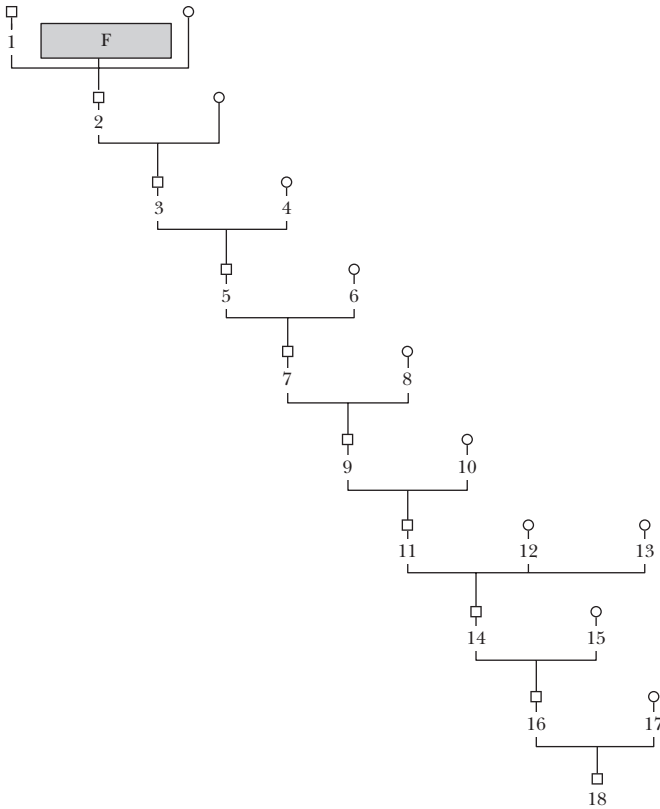

- F Founder of the mayorazgo
- 1 Pedro Hurtado de Mendoza
- 2 Pedro Rodriguez de Aviles
- 3 Nofre Fontes de Albornozy y Aviles
- 4 Isabel Pagan Riquelme
- 5 Baltasar Fontes Riquelme
- 6 Petronila Riquelme de Aviles
- 7 Macias Fontes Riquelme  
(lord of Alguazas)
- 8 Catalina de Aviles y Fajardo
- 9 Baltasar Fontes y Aviles
- 10 Isabel Francisca Carrillo Marin

- 11 Macias Fontes Carrillo  
(first marquis of Torre Pacheco)
- 12 Ana Ceferina Melgarejo y Galtero
- 13 Josefa Mariana Perez Evia de Merlos
- 14 Baltasar Fontes Melgarejo (second  
marquis of Torre Pacheco)
- 15 Nicolasa Maria de Paz y Castilla
- 16 Antonio Fontes Paz (third marquis  
of Torre Pacheco)
- 17 Francisca Riquelme y Buendia
- 18 Joaquin Fontes Riquelme  
(fourth marquis of Torre  
Pacheco)

Figure 4.13

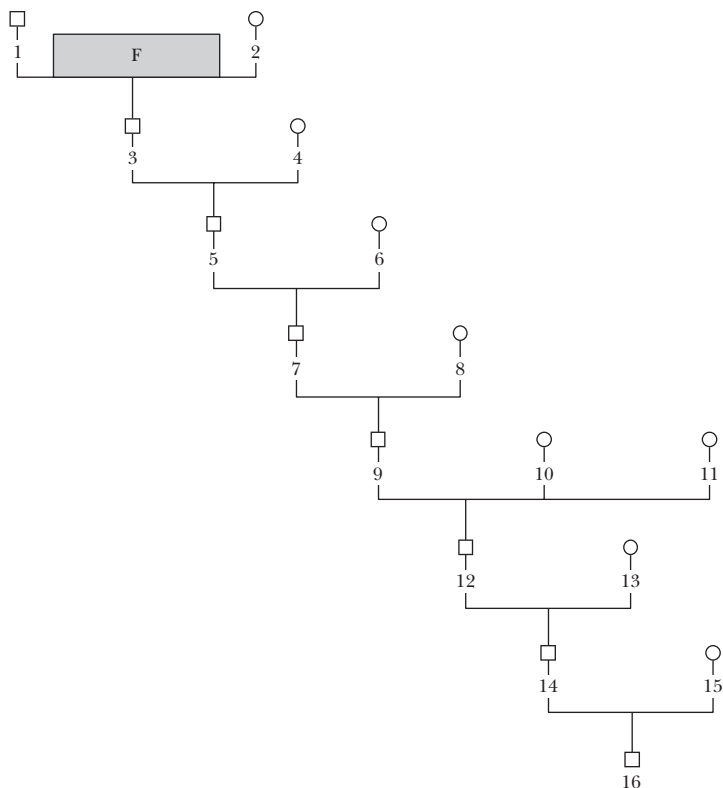

F Founders of the mayorazgo

1 Onofre Fontes de Albornoz

2 Isabel Pagan Riquelme

3 Baltasar Fontes Riquelme

4 Petronila Riquelme de Aviles

5 Macias Fontes Riquelme  
(lord of Alguazas)

6 Catalina de Aviles y Fajardo

7 Baltasar Fontes y Aviles

8 Isabel Francisca Carrillo Marin

9 Macias Fontes Carrillo  
(first marquis of Torre Pacheco)

10 Ana Ceferina Melgarejo  
y Galtero

11 Josefa Mariana Perez  
Evia de Merlos

12 Baltasar Fontes Melgarejo  
(second marquis of Torre Pacheco)

13 Nicolasa Maria de Paz y Castilla

14 Antonio Fontes Paz  
(third marquis of Torre Pacheco)

15 Francisca Riquelme y Buendia

16 Joaquin Fontes Riquelme  
(fourth marquis of Torre  
Pacheco)

Figure 4.14

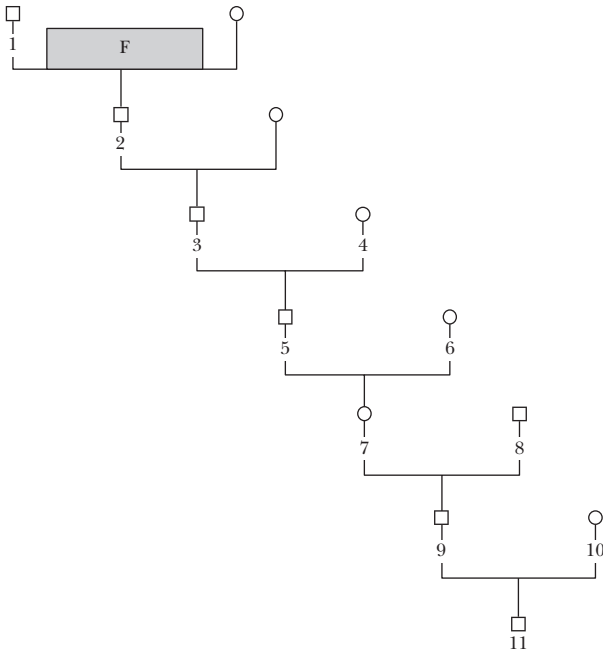

- |   |                                       |    |  |
|---|---------------------------------------|----|--|
| F | Founder of the mayoralazgo            | 7  | Nicolasa de Paz y Castilla                                     |
| 1 | Alonso de Paz                         | 8  | Baltasar Fontes Melgarejo<br>(second marquis of Torre Pacheco) |
| 2 | Alonso Antonio de Paz                 | 9  | Antonio Fontes Paz<br>(third marquis of Torre Pacheco)         |
| 3 | Francisco Alonso de Paz               | 10 | Francisca Riquelme y Buendia                                   |
| 4 | Mariana de Castilla                   | 11 | Joaquin Fontes Riquelme<br>(fourth marquis of Torre Pacheco)   |
| 5 | Francisco Alonso de<br>Paz y Castilla |    |  |
| 6 | Ana Polizena Espinosa y Paz           |    |  |

Figure 4.15

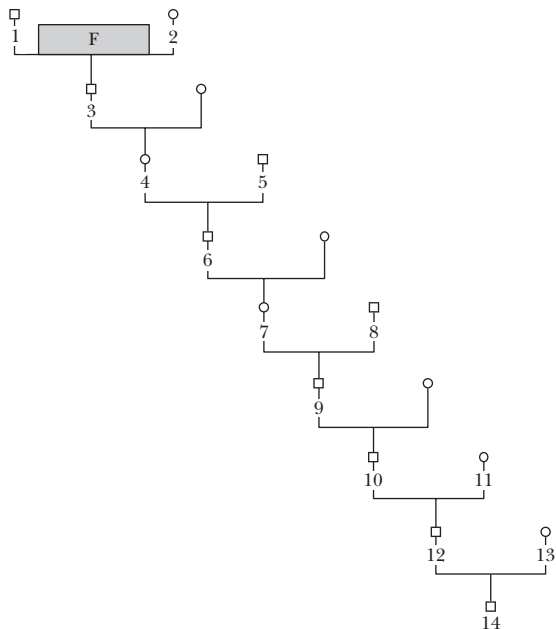

F Founder of the mayorazgo

1 Jaime Rocamora

2 Ginesa Ruiz

3 Jaime de Rocamora y Ruiz

4 Isabel de Rocamora y Ruiz

5 Pedro Carrillo Manuel y Albornoz

6 Ambrosio Carrillo Manuel

7 Isabel Francisca Carrillo Marin

8 Baltasar Fontes y Aviles

9 Macias Fontes Carrillo  
(first marquis of Torre Pacheco)

10 Baltasar Fontes Melgarejo  
(second marquis of Torre Pacheco)

11 Nicolasa Maria de Paz y Castilla

12 Antonio Fontes Paz  
(third marquis of Torre Pacheco)

13 Francisca Riquelme y Buendia

14 Joaquin Fontes y Riquelme (fourth  
marquis of Torre Pacheco)

Figure 4.16

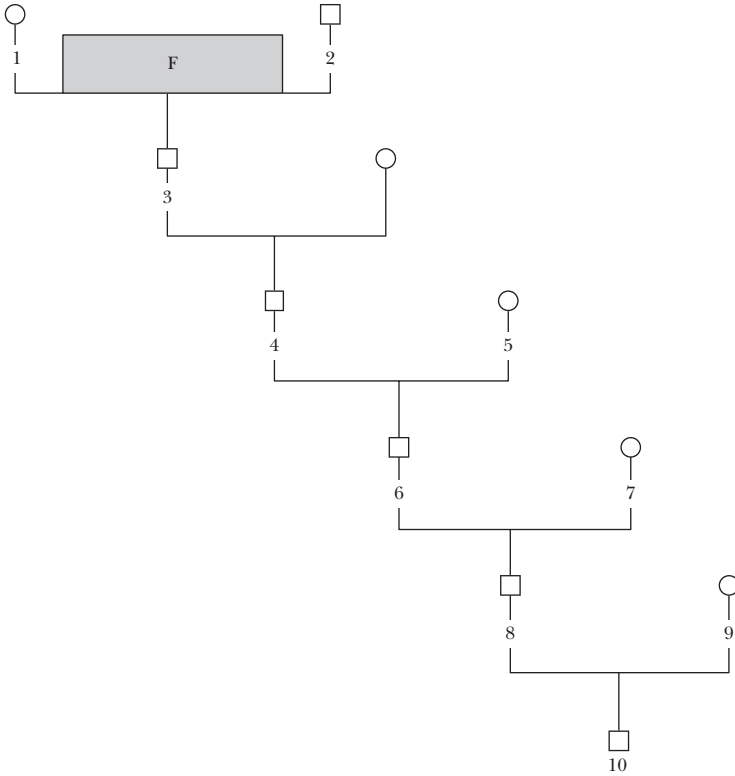

- F Founder of the mayorazgo
- 1 Ana de Moya
- 2 Diego Melgarejo Riquelme
- 3 Francisco Muñoz de Melgarejo
- 4 Macias Fontes Carrillo  
(first marquis of Torre Pacheco)
- 5 Ana Melgarejo

- 6 Baltasar Fontes Melgarejo  
(second marquis of Torre Pacheco)
- 7 Nicolasa Maria de Paz y Castilla
- 8 Antonio Fontes Paz  
(third marquis of Torre Pacheco)
- 9 Francisca Riquelme y Buendia
- 10 Joaquin Fontes Riquelme  
(fourth marquis of Torre Pacheco)



Figure 4.17

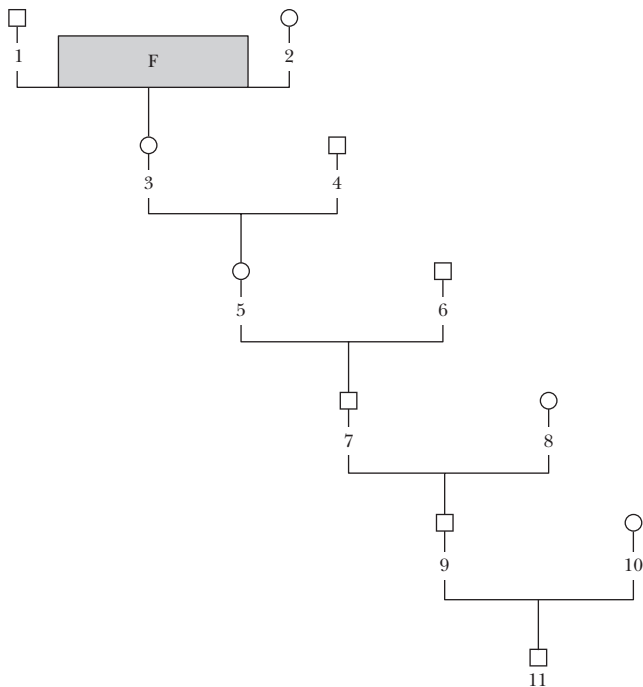

F Founder of the mayorazgo

1 Juan Damian de la Peraleja

2 Luisa Tomas

3 Dionisia Galtero de la Peraleja

4 Diego Melgarejo de Mora

5 Ana Ceferina Melgarejo y Galtero

6 Macias Fontes Carrillo  
(first marquis of Torre Pacheco)

7 Baltasar Fontes Melgarejo  
(second marquis of Torre Pacheco)

8 Nicolasa Maria de Paz y Castilla

9 Antonio Fontes Paz  
(third marquis of Torre Pacheco)

10 Francisca Riquelme y Buendia

11 Joaquin Fontes Riquelme  
(fourth marquis of Torre Pacheco)

Figure 4.18

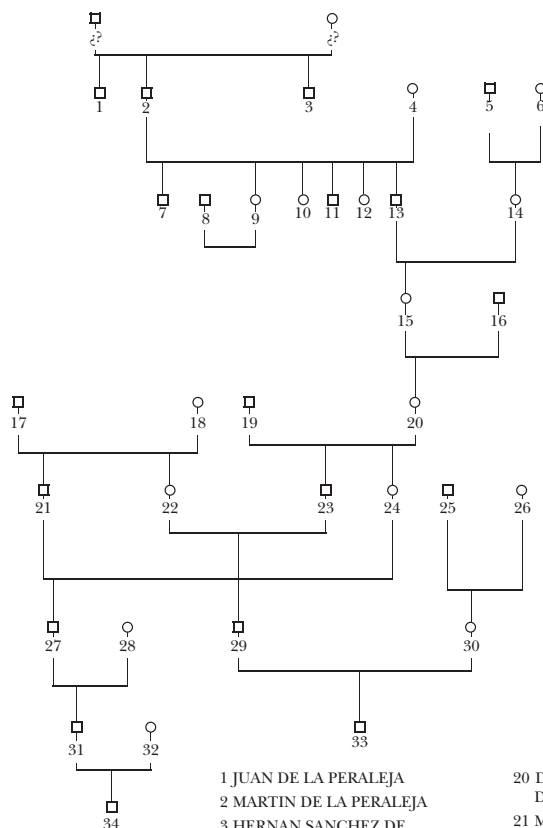

- 1 JUAN DE LA PERALEJA
- 2 MARTIN DE LA PERALEJA
- 3 HERNAN SANCHEZ DE LA PERALEJA
- 4 GERONIMA TOMAS
- 5 RAMON DE PALAZOL
- 6 NICOLASA GALTERO
- 7 FERNANDO DE LA PERALEJA
- 8 ANTONIO MOLINA CARRILLO
- 9 LUISA DE LA PERALEJA
- 10 BEATRIZ DE LA PERALEJA
- 11 ANTONIO DE LA PERALEJA
- 12 CATALINA DE LA PERALEJA
- 13 JUAN DAMIAN DE LA PERALEJA
- 14 LUISA TOMAS
- 15 MARIA DE LA PERALEJA
- 16 DIEGO MARTINEZ GALTERO MELGAREJO
- 17 BALTASAR FONTES Y AVILES
- 18 ISABEL FRANCISCA CARRILLO MARIN
- 19 DIEGO MELGAREJO DE MORA

- 20 DIONISIA GALTERO DE LA PERALEJA
- 21 MACIAS FONTES CARRILLO I Marqués de Torre Pacheco
- 22 CATALINA FONTES CARRILLO
- 23 FRANCISCO MELGAREJO Y GALTERO Conde del Valle de S. Juan
- 24 ANA CEFERINA MELGAREJO GALTERO
- 25 PEDRO PUXMARÍN Y FAJARDO Señor de Montealegre
- 26 JUANA VILLANUE VA Y CARCELEN
- 27 BALTASAR FONTES MELGAREJO II Marqués de Torre Pacheco
- 28 NICOLASA MARIA DE PAZ Y CASTILLA
- 29 DIEGO MELGAREJO
- 30 JUANA PUXMARIN Y VILLANUEVA
- 31 ANTONIO FONTES PAZ III Marqués de Torre Pacheco
- 32 FRANCISCA RIQUELME Y BUENDÍA
- 33 FERNANDO MELGAREJO Y PUXMARIN
- 34 JOAQUIN FONTES RIQUELME III Marqués de Torre Pacheco

Figure 4.19

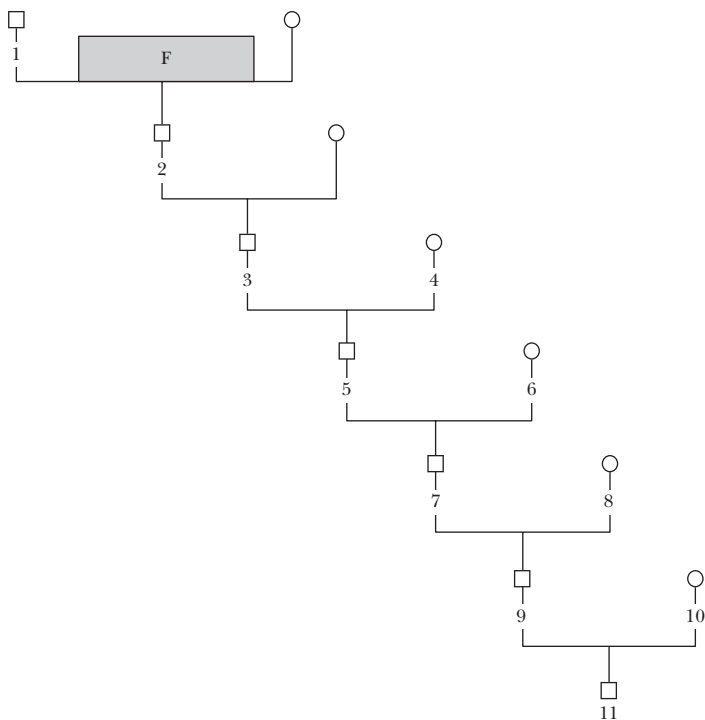

F Founder of the mayorazgo

1 Bernardino Fontes de Albornoz Riquelme

2 Fabricio Fontes de Albornoz Riquelme

3 Baltasar Fontes y Aviles

4 Isabel Francisca Carrillo Marin

5 Macias Fontes Carillo  
(first marquis of Torre Pacheco)

6 Ana Ceferina Melgarejo y Galtero

7 Baltasar Fontes Melgarejo  
(second marquis of Torre Pacheco)

8 Nicolasa Maria de Paz y Castilla

9 Antonio Fontes Paz  
(third marquis of Torre Pacheco)

10 Francisca Riquelme y Buendia

11 Joaquin Fontes Riquelme  
(fourth marquis of Torre Pacheco)

Figure 4.22

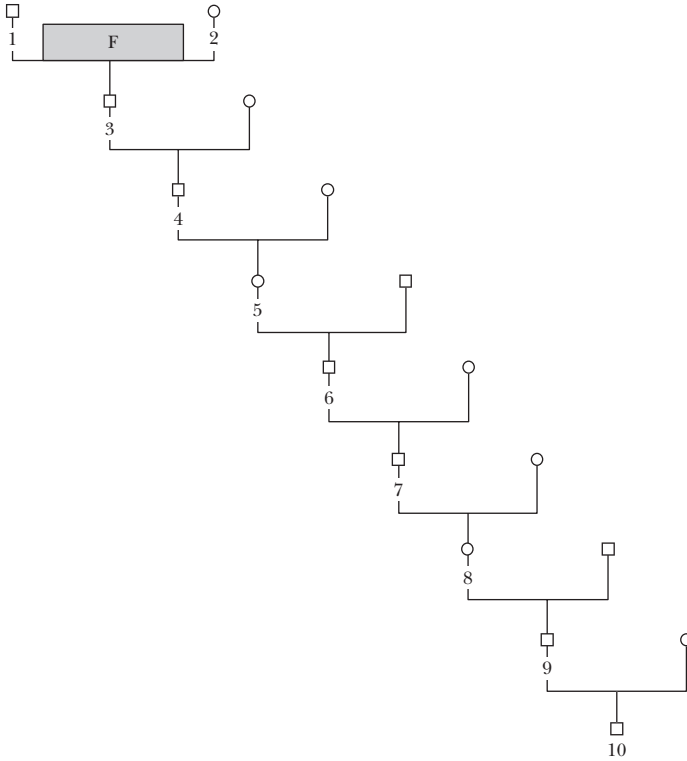

- |   |                                    |    |   |
|---|------------------------------------|----|---|
| F | Founders of the<br>mayorazgo       | 5  | Antonia Riquelme Muñoz y Robles   |
| 1 | Gaspar de Salafranca               | 6  | Bernardo de Salafranca  |
| 2 | Ana de Zuñiga                      | 7  | Bernardo de Salafranca  |
| 3 | Bernardo Salafranca<br>y Zuñiga    | 8  | Maria del Carmen Salafranca y Riquelme                                    |
| 4 | Francisco Ignacio<br>de Salafranca | 9  | Bernardo Riquelme Salafranca<br>Fontes y Rocha (first marquis of Pinares) |
|   |                                    | 10 | Antonio Riquelme y Fontes<br>(lord of Guadalupe)                          |

Figure 4.23

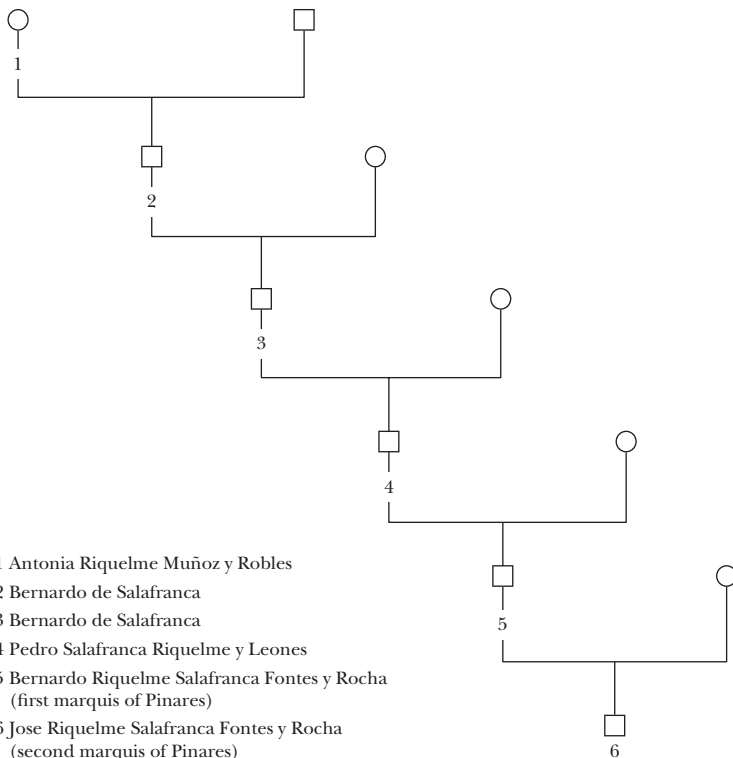

Figure 4.24

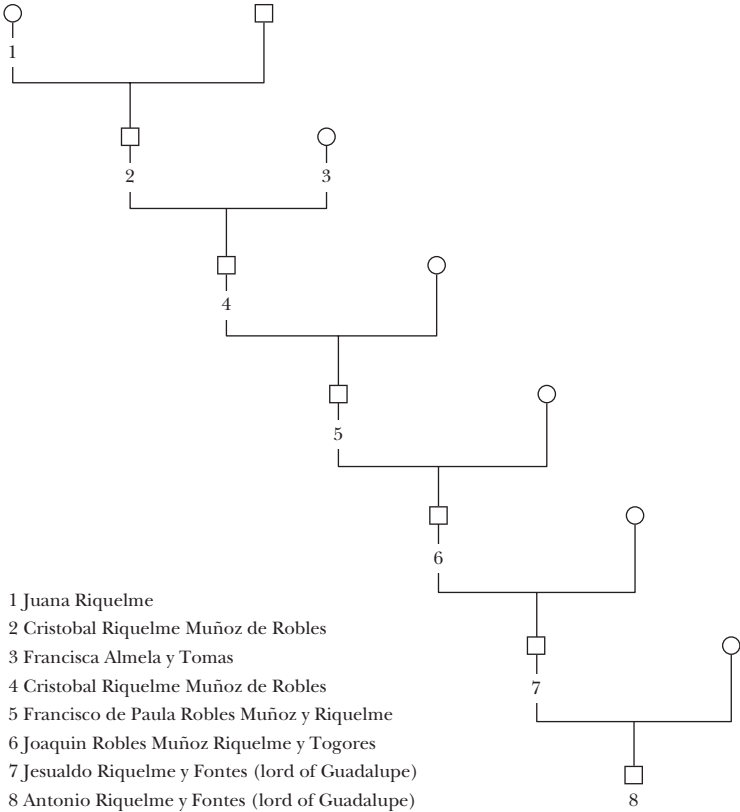
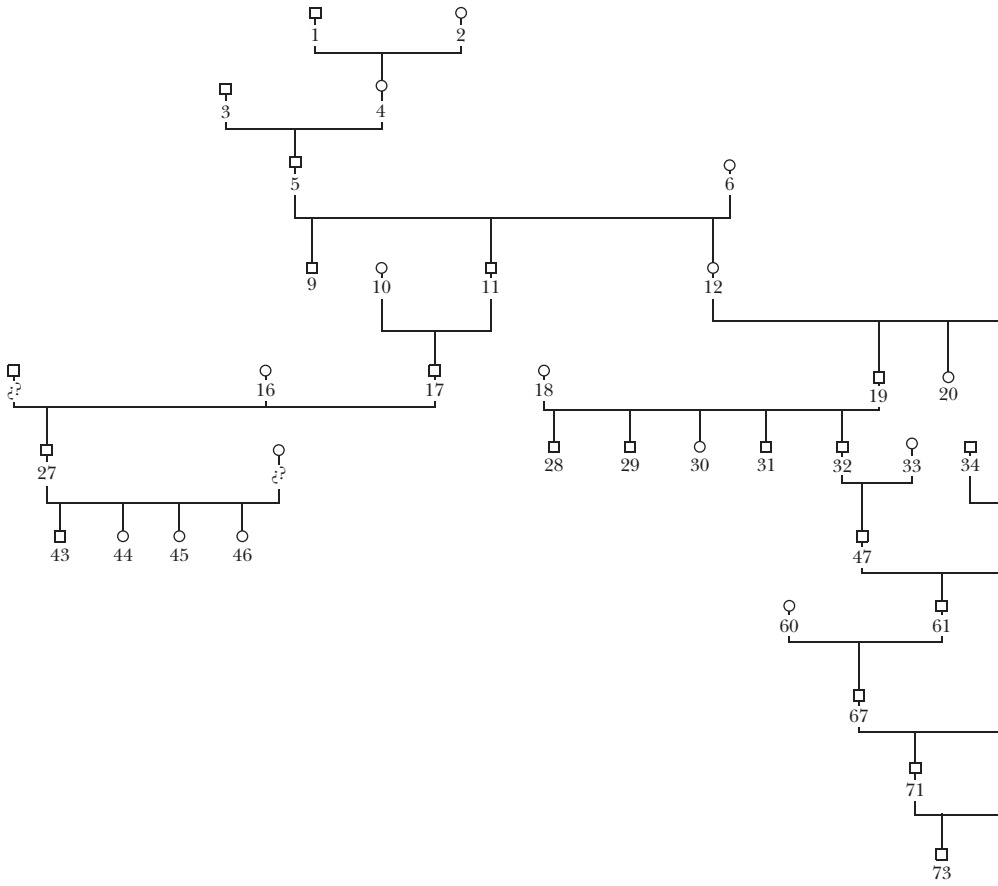
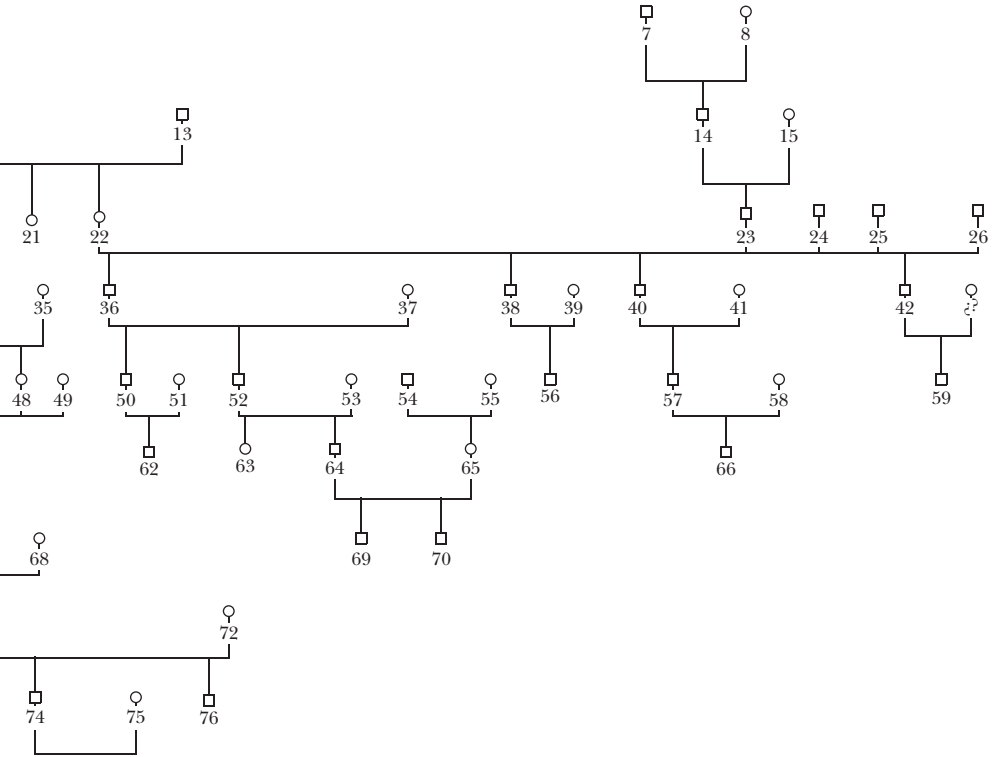

Figure 4.25





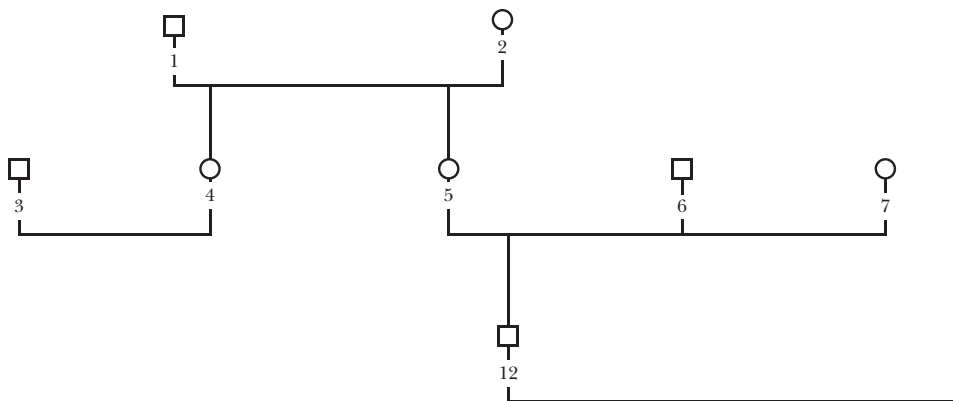

**Figure 4.25**

- |   |                                       |
|---|---------------------------------------|
| 1 JUAN DE BUSTAMANTE  | 20 BEATRIZ RIQUELME MUÑOZ DE ROBLES   |
| 2 GINESA ZAMORA   | 21 CONSTANZA RIQUELME MUÑOZ DE ROBLES |
| 3 DIEGO RIQUELME DE COMONTES III<br>Señor de Coy                        | 22 ANTONIA RIQUELME MUÑOZ DE ROBLES   |
| 4 BEATRIZ DE BUSTAMANTE   | 23 FRANCISCO IGNACIO DE SALAFRANCA    |
| 5 CRISTOBAL RIQUELME DE COMONTES IV<br>Señor de Coy                     | 24 GONZALO DE SAAVEDRA Y FAJARDO      |
| 6 ANTONIA DE ARRONIZ RIQUELME   | 25 ANTONIO DE MONTOYA                 |
| 7 GASPAR DE SALAFRANCA  | 26 JUAN DE ROBLES DAVILA              |
| 8 ANA DE ZUÑIGA   | 27 JOSE ANTONIO DE ROCAMORA           |
| 9 SEBASTIAN RIQUELME  | 28 JOSE RIQUELME MUÑOZ Y ROBLES       |
| 10 ISABEL DE BALIBREA   | 29 ANTONIO RIQUELME MUÑOZ Y ROBLES    |
| 11 CRISTOBAL RIQUELME Y ARRONIZ V<br>Señor de Coy VI Señor de Sto Angel | 30 FRANCISCA RIQUELME MUÑOZ Y ROBLES  |
| 12 MARIA RIQUELME Y ARRONIZ   | 31 JUAN RIQUELME MUÑOZ Y ROBLES       |
| 13 JUAN PEDRO MUÑOZ DE ROBLES   | 32 CRISTOBAL RIQUELME MUÑOZ Y ROBLES  |
| 14 BERNARDO SALAFRANCA Y ZUÑIGA   | 33 CONSTANZA GALTERO Y CEBALLOS       |
| 15 FRANCISCA PEREZ JORQUERA   | 34 LUIS TOGORES                       |
| 16 FRANCISCO ROCAMORA   | 35 FRANCISCA DE ROBLES GALTERO        |
| 17 JUANA RIQUELME   | 36 LINO DE SALAFRANCA Y RIQUELME      |
| 18 FRANCISCA ALMELA Y TOMAS   | 37 JACINTA DE LA REGUERA Y LEONES     |
| 19 CRISTOBAL RIQUELME MUÑOZ DE ROBLES                                   | 38 BERNARDO DE SALAFRANCA             |
|   | 39 MARIA BARBANZA FERNANDEZ           |

- 40 PEDRO DE SALAFRANCA Y RIQUELME  
 41 AGUSTINA RUIZ MATEOS  
 42 MARIA RIQUELME DE MONTOYA  
 43 JOSE NICOLAS ROCAMORA  
 44 INES ROCAMORA  
 45 JOSEFA ROCAMORA  
 46 GREGORIA ROCAMORA  
 47 FRANCISCO DE PAULA  
 RIQUELME Y ROBLES  
 48 ISABEL DE TOGORES Y ROBLES  
 49 IRENE GALTERO  
 50 JUSTO SALAFRANCA Y RIQUELME  
 51 MARIA TERESA ROSSIQUE  
 52 PEDRO SALAFRANCA  
 RIQUELME Y LEONES  
 53 TERESA DE LA ROCHA  
 54 ANTONIO FONTES PAZ III  
 Marqués de Torre Pacheco  
 55 FRANCISCA RIQUELME Y BUENDIA  
 56 BERNARDO DE SALAFRANCA  
 57 FRANCISCO SALAFRANCA  
 Y RIQUELME  
 58 ESTEFANIA GARCIA CAMPERO  
 59 DIEGO RIQUELME DE MONTOYA  
 60 ANTONIA FONTES PAZ  
 61 JOAQUIN ROBLES RIQUELME Y TOGORES  
 62 JUSTO RIQUELME SALAFRANCA  
 63 MARIA DEL CARMEN SALAFRANCA Y RIQUELME  
 64 BERNARDO SALAFRANCA RIQUELME Y ROCHA  
 I Marqués de Pinares  
 65 MARIA DE LOS REMEDIOS FONTES RIQUELME  
 66 FRANCISCO FAUSTINO LINO SALAFRANCA  
 Y RIQUELME  
 67 JESUALDO RIQUELME Y FONTES Señor de Guadalupe  
 68 MARIA DE LA CONCEPCION FONTES RIQUELME  
 69 JOSE RIQUELME SALAFRANCA Y FONTES  
 II Marqués de Pinares  
 70 JOAQUIN RIQUELME SALAFRANCA Y FONTES  
 71 ANTONIO RIQUELME Y FONTES Señor de Guadalupe  
 72 JOSEFA ARCE Y FLORES  
 73 ANTONIO RIQUELME Y ARCE Marqués de la Almenas  
 74 TERESA RIQUELME Y ARCE Marquesa de las Almenas  
 75 RAFAEL DE BUSTOS Y CASTILLA Marqués de Corvera  
 76 JOSE RIQUELME Y ARCE

Figure 4.26



- 1 JUAN DE JUNCO
- 2 FRANCISCA BALLESTER
- 3 PEDRO NOGUEROL Y CORDOBA
- 4 FRANCISCA DE JUNCO
- 5 LUCIA JUNCO
- 6 ALONSO DE ALMELA
- 7 FABLANA SALAD Y ANDUGA
- 8 MACIAS FONTES RIQUELME
- 9 CATALINA DE AVILES Y FAJARDO
- 10 PEDRO FONTES DE ALBORNOZ  
Y GUEVARA Señor de Ceutí

- 11 JOSEFA TOMAS Y TOMAS
- 12 PABLO FULGENCIO DE ALMELA Y JUNCO
- 13 LAURA FONTES Y AVILES
- 14 JUANA FONTES DE ALBORNOZ Y TOMAS
- 15 JUAN PEDRO MUÑOZ DE ROBLES
- 16 MARIA RIQUELME Y ARRONIZ
- 17 FRANCISCA ALMELA Y TOMAS
- 18 CRISTOBAL RIQUELME MUÑOZ DE ROBLES
- 19 CRISTOBAL RIQUELME MUÑOZ DE ROBLES
- 20 CONSTANZA GALTERO CEBALLOS

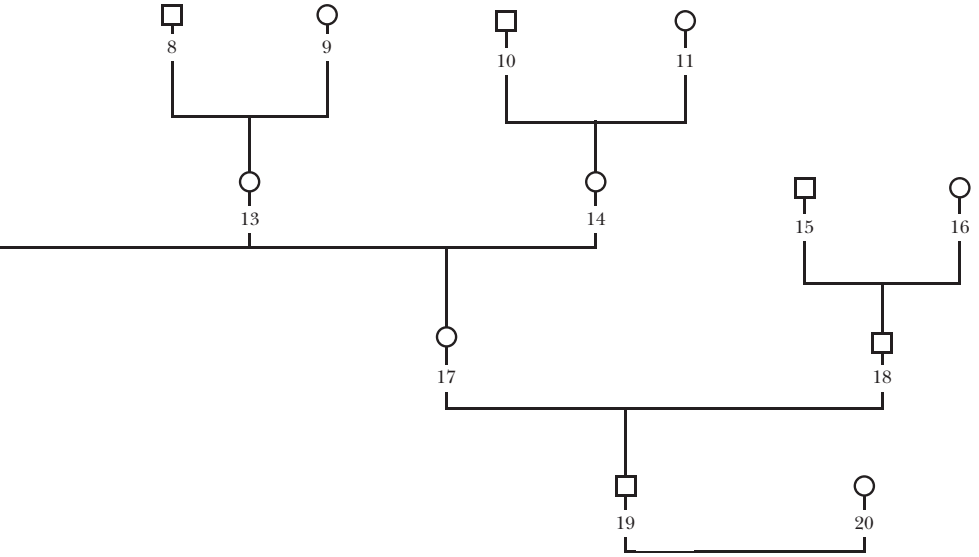
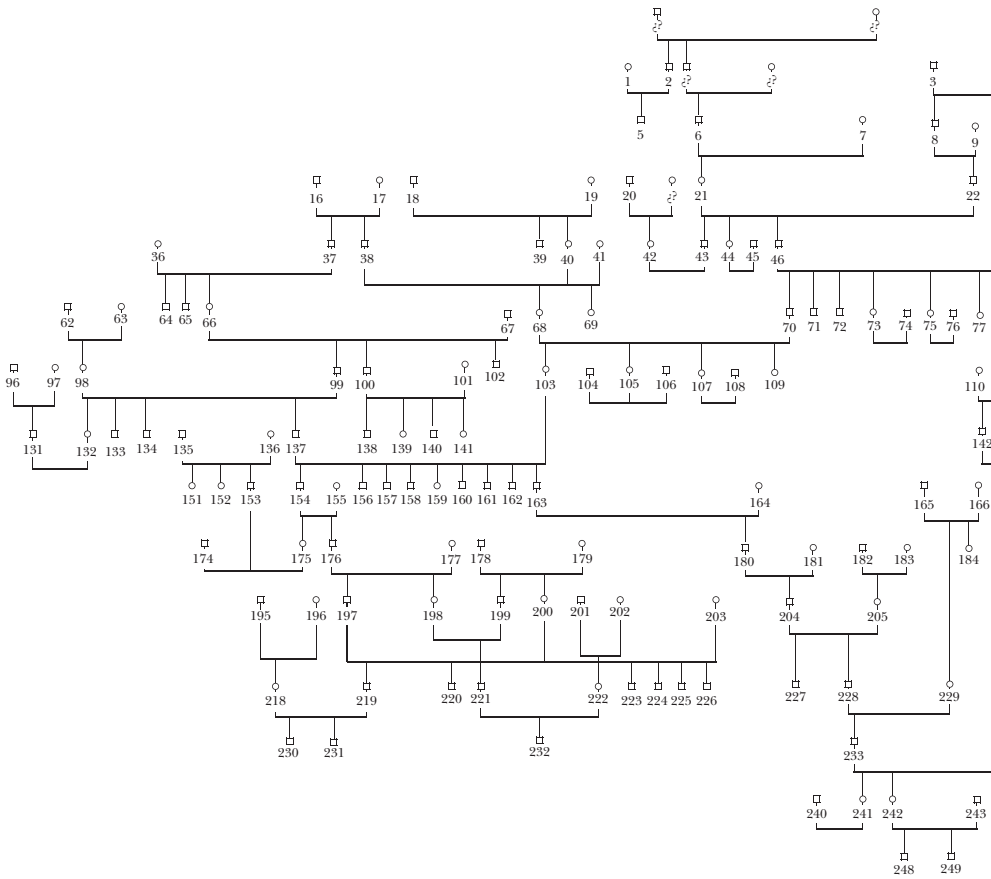

Figure 4.27



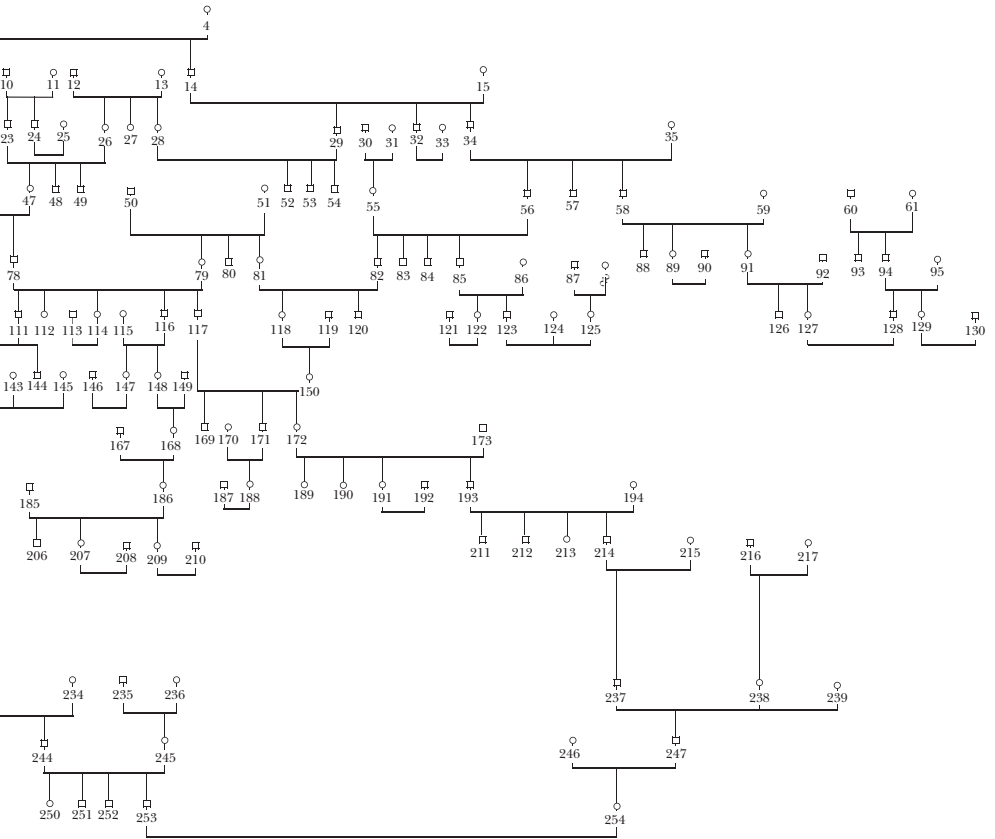

Figure 4.27

1 TERESA ALFONSO	46 ALONSO RIQUELME DE COMONTES II Señor de Coy	93 MARTIN RIQUELME "el Soldado"
2 GARCIA ALFONSO	47 INES COQUE	94 GERONIMO RIQUELME
3 FRANCISCO RIQUELME	48 MACIAS COQUE	95 MENCIA DE ARRONIZ PADILLA
4 ISABEL GOMEZ DAVALOS	49 LUIS COQUE	96 PEDRO SAAVEDRA Y AVELLANEDA
5 DIEGO DE COMONTES Obispo de Cartagena	50 JUAN DE BUSTAMANTE	97 FABIANA FAJARDO BRIAN
6 JUAN DE VILLAGOMEZ COMONTES	51 GINESA DE ZAMORA	98 ISABEL PAGAN RIQUELME
7 MARIA CERON	52 ALONSO RIQUELME	99 NOFRE FONTES DE ALBORNOZ Y AVILES
8 ALONSO RIQUELME DAVALOS	53 FADRIQUE RIQUELME	100 JUAN FONTES DE ALBORNOZ
9 CATALINA DE QUIROS	54 DIEGO RIQUELME	101 FLORENCIA DE GUEVARA Y HURTADO DE MENDOZA
10 BARTOLOME COQUE	55 NOFRA RIQUELME DE ALBORNOZ	102 HERNANDO* DE ALBORNOZ
11 INES LAMBERT	56 CRISTOBAL RIQUELME DE ARRONIZ III Señor de Santo Angel	103 PETRONILA RIQUELME DE AVILES
12 ALONSO MARTINEZ	57 FRANCISCO RIQUELME DE ARRONIZ	104 GASPAR ROCAFULL
13 ALDONÇA RABAÇA	58 JUAN RIQUELME DE ARRONIZ	105 NICOLASA RIQUELME DE AVILES
14 DIEGO RIQUELME I Señor Sto Angel	59 CONSTANZA DE LA PERALEJA	106 RODRIGO PUXMARIN
15 BEATRIZ DE BOMBAU	60 LORENZO RIQUELME BARRIENTOS	107 LUISA COQUE
16 CATALINA* RIQUELME	61 ISABEL FAJARDO	108 ALONSO BALIBREA
17 JUAN* DE AVILES	62 GONZALO PAGAN RIQUELME	109 ISABEL COQUE RIQUELME
18 Dr. JUAN FONTES Y MIRON	63 JUANA MONREAL	110 LUISA* FONTES DE ALBORNOZ Y GUEVARA
19 ISABEL DE ALBORNOZ Y ROCA	64 PEDRO DE AVILES	111 DIEGO RIQUELME DE COMONTES
20 JUAN MANUEL	65 BERNARDO DE AVILES	112 INES RIQUELME
21 ALDONZA DE COMONTES VILLAGOMEZ	66 ANA DE AVILES BERNAL	113 FRANCISCO GALTERO
22 DIEGO RIQUELME DAVALOS I Señor Campo Coy	67 CRISTOBAL* FONTES DE ALBORNOZ	114 ALDONZA RIQUELME
23 FRANCISCO COQUE	68 CONSTANZA DE AVILES FONTES	115 JUANA* FONTES DE ALBORNOZ Y GUEVARA
24 BARTOLOME COQUE	69 BLANCA* DE AVILES	116 FADRIQUE RIQUELME
25 ANTONIA VERGOÑOZ	70 MACIAS COQUE RIQUELME	117 CRISTOBAL RIQUELME DE COMONTES IV Señor de Coy
26 ANA MARTINEZ	71 BERNARDINO RIQUELME	118 GREGORIA RIQUELME BUSTAMANTE
27 BLANCA * MARTINEZ	72 FABRICIO RIQUELME	119 LUIS ARRONIZ Y VILLASEÑOR
28 MARIA MARTINEZ	73 BEATRIZ RIQUELME	120 CRISTOBAL RIQUELME
29 FRANCISCO RIQUELME	74 ESTEBAN GUIL	121 LAZARO USODEMAR Señor de Alcantarilla
30 LUIS RIQUELME DE ALBORNOZ	75 INES RIQUELME	122 NOFRA RIQUELME
31 CATALINA DE VALENÇU AVILES Conde de Albaterra	76 PEDRO CARRILLO DE ALBORNOZ	123 LUIS RIQUELME V Señor de Santo Angel
32 CATALINA* RIQUELME	77 GERONIMA RIQUELME	124 JUANA DE JUNTERON
33 JUAN* DE AVILES	78 DIEGO RIQUELME DE COMONTES III Señor de Coy	125 PETRONILA DE RODA Y PEREA
34 PEDRO RIQUELME II Señor de Sto Angel	79 BEATRIZ DE BUSTAMANTE	126 MIGUEL DE VALCARCEL Señor de Agramon
35 CONSTANZA ARRONIZ	80 CRISTOBAL DE BUSTAMANTE	127 ANA DE VALCARCEL RIQUELME
36 CONSTANZA BERNAL	81 ISABEL DE BUSTAMANTE	128 ALONSO RIQUELME DE BARRIENTOS
37 DIEGO RIQUELME DE AVILES	82 FRANCISCO RIQUELME	129 BEATRIZ RIQUELME
38 GONZALO RODRIGUEZ DE AVILES Conde de Albaterra	83 PEDRO RIQUELME Y RIQUELME	130 FRANCISCO DE ARRONIZ ROCAMORA
39 CRISTOBAL* FONTES DE ABORNOZ	84 ALONSO RIQUELME	131 JUAN DE SAAVEDRA FAJARDO
40 ISABEL FONTES Condesa de Albaterra	85 NOFRE RIQUELME DE ARRONIZ IV Señor de Santo Angel	132 CLARA FONTES DE ALBORNOZ Y PAGAN
41 BLANCA * MARTINEZ	86 BLANCA* DE AVILES	133 GONZALO FONTES DE ALBORNOZ Y PAGAN
42 BEATRIZ MANUEL	87 ALONSO DE RODA	134 ALONSO FONTES DE ALBORNOZ Y PAGAN
43 CRISTOBAL RIQUELME DE COMONTES	88 PEDRO RIQUELME	135 PEDRO* FONTES DE ALBORNOZ GUEVARA Señor de Ceuti
44 SALVADORA RIQUELME	89 JUANA ARRONIZ RIQUELME	
45 JUAN FAJARDO	90 HERNANDO* DE ALBORNOZ	
	91 CONSTANZA RIQUELME	
	92 FRANCISCO VALCARCEL DE AGRAMON	

- 136 JOSEFA TOMAS Y TOMAS  
137 BALTASAR FONTES RIQUELME  
138 PEDRO\* FONTES DE ALBORNOZ  
GUEVARA Señor de Ceuti  
139 ANA FONTES DE ALBORNOZ  
Y GUEVARA  
140 CRISTOBAL FONTES DE  
ALBORNOZ Y GUEVARA  
141 MANUELA FONTES DE  
ALBORNOZ Y GUEVARA  
142 DIEGO RIQUELME  
143 FRANCISCA ALMELA  
144 LUIS RIQUELME  
145 LUISA GALTERO  
146 GERONIMO AVENDAÑO  
147 BEATRIZ RIQUELME Y FONTES  
148 FLORENCIA RIQUELME Y FONTES  
149 JUAN DE LOYOLA Y MOLINA  
150 ANTONIA DE ARRONIZ  
RIQUELME  
151 JUANA\* FONTES DE ALBORNOZ Y  
GUEVARA  
152 LUISA\* FONTES DE ALBORNOZ  
Y GUEVARA  
153 JUAN FONTES DE ALBORNOZ  
Y TOMAS  
154 MACIAS FONTES RIQUELME  
155 CATALINA DE AVILES FAJARDO  
156 GONZALO FONTES RIQUELME  
157 ALONSO FONTES RIQUELME  
158 FRANCISCO FONTES RIQUELME  
159 MARIA FONTES RIQUELME  
160 FABRICIO FONTES RIQUELME  
161 BERNARDINO FONTES RIQUELME  
162 ONOFRE FONTES RIQUELME  
163 CRISTOBAL FONTES RIQUELME  
164 LEONOR GARCIA DE OTALORA  
165 AMBROSIO CARRILLO MANUEL  
166 FLORENCIA MARIN RODA  
167 JUAN DE ZIAÑO  
168 JUANA BEATRIZ DE LOYOLA Y  
FONTES  
169 SEBASTIAN RIQUELME  
170 ISABEL DE BALIBREA  
171 CRISTOBAL RIQUELME Y  
ARRONIZ V Señor de Coy  
VI Señor de Santo Angel  
172 MARIA RIQUELME Y ARRONIZ  
173 JUAN PEDRO MUÑOZ DE ROBLES  
174 PABLO FULGENCIO DE  
ALMELA Y JUNCO  
175 LAURA FONTES Y AVILES  
176 BALTASAR FONTES Y AVILES  
177 ISABEL FRANCISCA\* CARRILLO  
MARIN  
178 DIEGO MELGAREJO DE MORA  
179 DIONISIA GALTERO DE  
LA PERALEJA  
180 ANTONIO FONTES DE ALBORNOZ  
181 JUANA VERASTEGUI MENDOZA  
182 SANCHE RIQUELME  
183 ANTONIA CEVELLON  
184 ISABEL FRANCISCA\* CARRILLO  
MARIN  
185 JOSE GALINDO PIQUINOTTI II  
Marques de Villaleal  
186 ANA DE ZIAÑO Y LOYOLA  
187 FRANCISCO ROCAMORA  
188 JUANA RIQUELME  
189 BEATRIZ RIQUELME MUÑOZ  
DE ROBLES  
190 CONSTANZA RIQUELME  
MUÑOZ DE ROBLES  
191 ANTONIA RIQUELME  
MUÑOZ DE ROBLES  
192 FRANCISCO IGNACIO DE  
SALAFRANCA  
193 CRISTOBAL RIQUELME MUÑOZ  
DE ROBLES  
194 FRANCISCA ALMELA Y TOMAS  
195 FRANCISCO DE PAZ  
196 ANA POLIZENA ESPINOSA DE PAZ  
197 MACIAS FONTES CARRILLO I  
Marques de Torre Pacheco  
198 CATALINA FONTES CARRILLO  
Condesa del Valle de S. Juan  
199 FRANCISCO MELGAREJO Y  
GALTERO Conde del Valle  
de S. Juan  
200 ANA CEFERINA MELGAREJO Y  
GALTERO  
201 PEDRO PUXMARIN Y FAJARDO  
Señor de Montealegre  
202 JUANA VILLANUEVA Y CARCELEN  
Señora de Montealegre  
203 JOSEFA MARIANA PEREZ EVIA DE  
MERLOS  
204 PEDRO FONTES  
205 JUANA RIQUELME Y CERVELLON  
206 JUAN FRANCISCO GALINDO  
PIQUINOTTI III Conde de Villaleal  
207 JOSEFA MARIA GALINDO  
PIQUINOTTI IV Condesa de Villaleal  
208 NICOLAS DE GRIMAU  
209 LUISA PIQUINOTTI Y GALINDO  
210 EUSTAQUIO ROCAMORA  
RUIZ Y MOLINS  
211 JOSE RIQUELME MUÑOZ ROBLES  
212 ANTONIO RIQUELME MUÑOZ  
ROBLES  
213 FRANCISCA RIQUELME MUÑOZ  
ROBLES  
214 CRISTOBAL RIQUELME MUÑOZ  
ROBLES  
215 CONSTANZA GALTERO CEBALLOS  
216 LUIS TOGORES  
217 FRANCISCA DE ROBLES GALTERO  
218 NICOLASA MARIA DE PAZ Y  
CASTILLA  
219 BALTASAR FONTES MELGAREJO  
220 ALEJANDRO FONTES MELGAREJO  
221 DIEGO MELGAREJO  
222 JUANA PUXMARIN Y VILLANUEVA  
223 ALEJANDRO  
224 PEDRO JOSE  
225 FRANCISCO  
226 TERESA  
227 RAFAEL FONTES RIQUELME  
228 ANTONIO FONTES RIQUELME  
229 CLAUDIA CARRILLO MARIN  
230 VENTURA FONTES PAZ  
231 ANTONIO FONTES PAZ  
232 FERNANDO MELGAREJO PUXMARIN  
233 PEDRO FONTES CARRILLO  
234 LUISA BIENVENGUD LIZANA Y  
LADRON DE GUEVARA  
235 MARIA JOSEFA SANDOVAL  
ZAMBRANA Y GUERRERO  
236 GABRIEL ORTEGA Marques  
de Valdeguerrero  
237 FRANCISCO DE PAULA ROBLES  
Y RIQUELME  
238 ISABEL DE TOGORES Y ROBLES  
239 IRENE GALTERO  
240 FRANCISCO GONZALEZ DE  
AVELLANEDA Y SANDOVAL  
241 CLAUDIA FONTES BIENVENGUD  
242 PATRICIA FONTES BIENVENGUD  
243 JOSE CARO Y ROCA Marques  
de la Romana  
244 ANTONIO FONTES CARRILLO  
BIENVENGUD Y ARCE  
245 MARIA GERONIMA ORTEGA  
ZAMBRANA Y GUERRERO  
246 MANUELA ROBLES MOLINA  
Y SERRANO  
247 JOAQUIN ROBLES RIQUELME  
Y TOGORES  
248 JOSE RAIMUNDO CARO Y FONTES  
249 PEDRO CARO Y FONTES  
Marques de la Romana  
250 ISABEL FONTES ORTEGA  
251 RODRIGO FONTES ORTEGA  
252 DIEGO FONTES ORTEGA  
253 ANTONIO FONTES ORTEGA  
CARRILLO Y ZAMBRANA  
254 LUISA RIQUELME-ROBLES  
SERRANO Y TOGORES-MOLINA



This page is deliberately blank

# Index

---

- Acta capitular* 166  
*Adelantado* 15, 18–21, 27–9,  
42–3, 106–7  
    *adelantado mayor* 15–18, 21–2,  
26–8, 113, 261  
Africa 17, 32–4  
    Algiers 33  
    *berberisco* 17  
    Bougie 33  
    North Africa 17  
*Agnático* 114, 167  
    *agnatic line* 114  
Alburquerque 57  
*Alcaide* 28, 30  
    *alcaldías* 112  
Alcalá 24, 26  
Alcalá la Real 119, 277  
*Alcalde* 18, 22, 26, 74, 89, 120  
Aledo 30  
*Alferez* 52, 74, 194  
    *alferez de Justicia del Regimiento de*  
    *Dragones* 85  
Alfonso I 20  
Alfonso X the Wise 9, 11–12,  
24–5, 55  
Alfonso XI 15–16, 19, 23–4,  
25–6, 222  
*Alguacil Mayor* 97  
Alhama 30, 277  
Almeida 26  
*Almogávares* 18  
*Almojarifazgo* 191, 295  
Alporchones 28  
Álvaro de Bazan 68  
    *ancien régime* 1–2, 4–5, 47, 104,  
    105–6, 128, 134–6, 154, 209,  
    221, 224, 226, 227  
Andalucía 47, 118  
Andújar Castillo, F. 277  
Annual Tributes 192  
    *alcabalas* 191  
    *pechos* 25  
    *tributo* 192  
Aracena 74  
aristocracy 13, 15, 23, 30  
aristocratisation 21  
*Arrendamiento* 152–3  
assets 165  
*Audiencia Episcopal* 74  
Ávila 28, 111  
Ayala lineage 15  
  
Badajoz 74  
baptism 135, 144, 168  
baroque 41, 223  
    European baroque society 2  
    Spanish baroque 49, 53, 79  
*bastimentos* 26  
battle of Aljubarrota 25  
Baza 27, 30, 52, 119, 224  
Belgium 6  
Belluga 63  
Benaiteau, M. 43  
Bennassar, B. 47  
Berlanga 73, 76, 77  
Bertrand, M. 111  
Bienvendud 55, 83, 84, 114,  
119, 162

- Bourbon reforms 86  
*bula de cruzada* 29  
*bulas apostólicas* 98  
 Bustamante 39, 49, 50, 173, 178,  
 205, 207–8, 209, 211, 212, 213
- Campo Coy 23, 30–1, 117, 169,  
 175, 177, 179, 205, 224  
*capellanías* 180, 190  
*capellán* 180, 190  
*fundaciones pías* 76  
*obras pías* 76
- capital accumulation 46  
 wealth accumulation 169, 187  
*capitulaciones matrimoniales* 287  
*alhajas* (jewellery) 134  
*arras* 128, 129–34  
*arreglos* 166  
*bucle matrimonial* (marriage turn)  
 115, 116, 118, 182, 225  
 consanguineal marriages 116–17  
 consanguinity 4, 8, 42, 114, 115,  
 116, 225  
 crossed marriages 108–9,  
*dispensa apostólica* (apostolic  
 exemption) 115  
 double marriages 108, 121–2,  
 166  
 dowry 128–34, 153  
 marriage strategies 8, 21, 30,  
 105, 106–7, 110–11, 116, 135,  
 164, 165, 192, 225
- captain (*capitán*) 9, 10, 28, 32, 33,  
 62  
*capitán de caballos* 30, 33  
*capitán de lanzas* 30  
*capitán del Regimiento de Dragones*  
 85
- Caravaca 43, 52, 53, 169, 173, 179,  
 180, 194, 224, 225
- Carmelitas Descalzas 128
- Caro Baroja, J. 46
- Carrillo 55, 56, 84, 98, 114, 118,  
 119, 128, 152, 195, 198, 199,  
 200, 206, 278
- Cartagena 19, 28, 86, 109, 110,  
 173, 175, 182, 183, 203
- bishopric of Cartagena 110, 112  
 Santa Iglesia of Cartagena 175
- casa* (house) 2  
*armas* (coats of arms) 205–6, 208  
*fundador de la casa* (founder of  
 the house) 2  
 material culture 31, 42  
*pater familias* 2
- Cascales, Francisco xxi, 10, 31  
*Discursos históricos* xxi, 10, 31
- Casey, J. 1, 8
- Castile 24, 25, 44, 49, 164  
 Castilian monarchy 7, 11, 16, 25,  
 28, 29, 32, 34  
 Castilian nobility 93, 107, 111,  
 134, 206  
 Crown of Castile 1, 44, 57, 79,  
 89, 107, 110, 134, 136, 166,  
 169, 205, 221  
 northern Castile 222  
 southern Castile 42, 45, 46, 106,  
 118, 222
- Catalina de Valibarrera Ceballos 49
- Catalina Musso 53, 179, 180, 181,  
 185
- Catholicism 45, 98  
 Catholic Europe 115, 116, 128,  
 135  
 Catholic monarchs 29–30, 31,  
 32, 34, 40, 45, 57, 109, 110,  
 223  
*Liga Santa* (Holy League) 32
- Cazalla 192
- Ceballos 48, 49, 63
- censo* (census) 25, 30, 183, 185–6,  
 191, 222  
*ensatario* 185–6
- Chancillería* 48, 154, 226  
 Granada 48, 168  
*Reales Chancillerías* 168  
*Tribunales de Justicia Ordinarios*  
 154, 168  
 Valladolid 168
- Charles II 56, 61, 84, 89
- Charles V 32, 33, 34, 68
- Charles VIII of France 32, 33
- China 6

- Chinchilla 98
- Christianity 23, 27, 29, 31, 42, 46, 57, 63, 68, 76, 80, 92, 98, 222, 223–4
- Christians 7, 27, 29, 40, 41, 45, 46
- Clement IV 97
- Clement VII 97
- clientelism 3, 5, 16, 105, 135, 136, 154, 159, 223, 225, 227
- ego* 120, 164
- fidelity 5, 43, 95, 223, 225
- friendship 4, 63, 136, 159, 226
- jefe-patrón* 120, 164, 166
- loyalty 16, 42, 63, 114, 226
- patrón* 16, 21–2, 165
- patrón-cliente* 107
- patronage 3, 4, 5, 105, 114, 134, 135, 136, 144, 154, 159, 165, 191, 223, 225, 227
- solidarity 42, 43, 63, 105, 114, 144, 159, 220, 223, 225, 226, 227
- cofradía* (brotherhood) 42, 93–5, 97–8, 101, 158–9, 224, 227
- Cofradía Nuestra Señora de la Soledad de Valencia* 101
- Cofradía de San Ildefonso* 98
- Cofradía de San Pedro Mártir de Verona* 93–4, 97, 98, 101
- Cofradía de Santiago de la Espada* 93–7, 101, 136, 154, 155, 156–8, 159, 160, 161, 226–7
- cofradías pasionarias* 136, 154
- hidalga cofradía* 97
- noble *cofradía* 42, 98, 136
- noble guilds 93
- Nuestro Padre Jesús Nazareno* 136, 154, 155–8, 159–61, 227
- cognaticia* line 118
- colegios* 101
- Colegial de Lorca* 123
- Colegio de la Compañía de Jesús* 76, 188–90
- Colegio de Santa Teresa de Jesús* 138
- Colegios Mayores* 80, 101
- comendador* 28, 43, 119
- comendador de Paradinas* 80, 107
- Comontes* 49, 80, 106, 108–10, 113, 117, 171, 173, 175, 178, 205, 207
- comunero revolt* 40, 41, 44–5, 55, 223
- concejo* 13, 15, 17–18, 19, 20, 21, 22, 25, 30, 33, 34, 40, 44, 48, 50, 52, 55, 57, 68, 80, 93, 110, 111, 112, 136, 221, 223, 224, 226
- hombres buenos* 20
- oficiales* 16, 18, 20
- conductor de Embajadores* 62
- Consejos Reales* 63, 86–8
- Consejo de Cámara* 60
- Consejo de Hacienda* 60
- Consejo de la Inquisición* 68
- Consejo de Ordenes* 60
- Consejo de Regencia* 20
- Consejo Secreto* of Llerena 67
- Consignación de viudedad* 150–1
- Contreras, J. 48
- conversos* 46, 57, 68
- converso judeizante* 47
- copero mayor* 30
- Coque 48, 80, 109, 116, 183
- Coque Riquelme 44, 48, 50, 51, 80, 116, 117, 118, 182, 183
- Coque Riquelme, Macías 48, 50, 51, 80, 116, 117, 118, 182, 183
- Coque Riquelme, Matias 44
- corregimiento* 277, 278
- count of Carrión 16–17, 261
- count-duke of Olivares 79
- court 1, 4, 14, 26, 29, 30, 32, 33, 42, 48, 50, 55, 56, 57, 61–2, 63, 86, 109, 110, 111, 120, 168, 182, 191, 205, 208–9, 223
- Court of Toro (*Cortes* of Toro) 32, 166, 205
- cristianos*
- criptojudío* 57
- cristiano nuevo* (new Christian) 18, 41, 45, 46, 47
- cristiano viejo* (old Christian) 41, 45, 50, 74, 75, 76, 115, 223
- crossed marriages 108–9, 110, 113

- Crown of Aragon 18  
 Cuenca 63, 101, 111
- de Baltanás, Domingo 47  
 de Bolaños Paz, Juan Antonio 58, 74  
 de Borja Fontes Riquelme, Francisco 85  
 de Bustamante, Isabel 49, 205, 207, 211, 212  
 de Ceballos, Luis 48, 49  
 de Lara, Diego 46, 47  
 de Paz, Francisco 62, 67–8, 74, 76  
   de Paz y Castilla, Francisco 61–3  
 de Robles, Juan 179, 180, 181, 182, 207  
 de Soto, Beatriz 43, 46, 47  
 de Soto, Diego 28  
 de Soto, Pedro 44  
 de Vega, Lope 42  
 Dedieu, J. P. 212  
 del Pulgar, Fernando 9  
 Delille, G. 43, 108  
 don Beltrán de la Cueva 28  
 don Hernando Enriquez de Ribera 192  
 don Juan Manuel 16  
 don Pedro Hurtado de Mendoza 175, 187  
 DUBY, G. 24  
 duke of Medina Sidonia 192
- ecclesiastical *cabildo* 57  
   *arcediano* 112, 183  
   *cabildo catedralicio* 46, 48, 109, 144  
   *canonjías* 46, 76, 106, 224  
   *clérigo de menores* 48  
   *chantre* 175, 187  
   dean 101, 159  
   *deanatos* 46  
   *raciones* 106  
 Écija 278  
 Elliot, J. H. 32  
*encomienda* 43, 80  
   *encomiendas santiaguistas* 43  
 endogamy 62, 108, 116, 120, 166, 226  
   endogamic marriages 113, 167  
 entailed estate (*mayorazgo*) xxiii, 8, 164–220  
   aggregations 200, 224  
   *emphyteusis* 164, 173, 291  
   family patrimony 13, 32, 114, 115, 117, 120, 152, 165–6, 224  
   *fideicommissum* 166  
   first-born 13, 115, 117, 118, 120, 128, 164, 165, 166, 167, 170, 187, 198, 203, 204, 211, 226  
   lawsuit 154, 168, 177, 204, 205  
   *Ley de Desvinculación de Mayorazgos* 209  
   male descendency 118  
   *morgadio* 8  
   *patrimonio vinculado* 167  
   *tenuta* 168  
   *vínculos (vinculum)* 120, 166, 188, 191–2, 198, 200, 203, 204, 207, 208  
*estatuto nobiliario* 89  
 European Catholic monarchies 40  
   European Counter-Reformation 40, 57, 93  
   Mediterranean Europe 3, 4, 8, 23, 105, 106, 108, 111, 116, 118, 119, 166, 221, 224  
 Extremadura 56, 57, 58, 67, 191, 223
- factions 17, 19, 21, 22, 23, 27, 28, 40, 41, 42–5, 46, 47–8, 50, 52, 56–8, 75, 76, 116  
*faide* 44  
*fajardista* 19–20, 21  
 Fajardo lineage 13, 15, 16, 19, 28, 43, 45, 107, 114  
 Fajardos 15, 16, 17, 19, 21, 22, 25, 26–7, 28, 30, 42, 43, 55, 106, 107, 113–14, 169, 222–3  
 Fajardo, Alonso '*el bravo*' 27, 28, 31, 42–3  
 Fajardo, Isabel 113  
 Fajardo, Pedro 27, 28, 42, 55  
 Ferdinand 30, 32  
 Ferdinand IV 13, 14

- Fernández de Córdoba, Gonzalo 32, 33
- Ferro 63
- Flanders 62
- Fontes 44, 54–5, 56–7, 63, 68, 73, 78–9, 83, 84, 85, 86, 87, 88, 94, 106, 114, 115, 119, 142, 143, 162, 187, 191, 223
- Fontes-Paz 69–71
- Fontes-Paz family 54
- Fontes Abad, Antonio 85, 93
- Fontes Carrillo, Macías 55, 56, 98, 128, 195, 198, 199, 206, 278
- Fontes de Albornoz, Cristóbal 49
- Fontes Melgarejo, Baltasar 56, 198, 200
- Fontes Ortega Carrillo y Zambra-  
na, Antonio 118
- Fontes Paz, Antonio (third  
marquis of Torre Pacheco) 56,  
85, 92, 94, 119–20, 136, 144,  
153, 154, 155, 156, 158, 187,  
191, 203, 204, 206
- Fontes Paz, Ventura 56, 58, 61, 63,  
68, 78, 206–7, 274
- Fontes Riquelme, María de la  
Concepción 118
- Fourth Lateran Council (1215) 8
- Frejenal de la Sierra 56, 57, 58,  
72–3, 191
- Friar Vicente Ferrer 45
- frontier 22–3, 27, 30, 31, 43, 45,  
169, 221, 222
- fronterizo* group 26
- global history 5, 6
- Gómez Dávalos, Isabel 18, 21, 27,  
28, 107
- Gómez Dávalos, Pedro 18, 20, 21,  
107, 261
- gran capitán* 32, 33
- Guadix 27
- guardia mayor* 33
- Guardiamarina* 87
- Guerrero 63, 84
- Habsburg 33
- Habsburgs 55,
- heir 9, 76, 118, 119, 120, 164, 165,  
166, 177, 187, 204, 205, 211,  
226
- inheritance system 114, 115, 165
- Henry II 16
- Henry III 20
- Henry IV 28
- Henry of Trastámara 16
- heredamientos* (inheritances) 7, 11
- heredad* 31, 173, 179, 194,  
198, 203
- peones* 11
- hidalgos* 15, 25
- hidalguía* 10, 92, 93, 95, 104
- hijoshidalgo* 32
- Hispanic Monarchy
- honour 7, 9, 11, 30, 31, 40, 41–2,  
46, 48, 56, 75, 79, 80, 86, 94,  
98, 104, 115, 179
- gentilhombre* 30
- gracias y mercedes* (graces and  
grants) 23, 105
- grandes* 32, 111
- hábito militar* (military  
uniform) 40
- immaterial capital 41
- nobility titles 2, 41, 85
- Pragmática de actos positivos* 68
- household 2, 5, 6
- fictitious kinship 4, 152
- kinship 3, 4, 8, 9, 15, 43, 68, 95,  
101, 105, 107, 116, 118, 120,  
135, 144, 152, 154, 166, 183,  
203, 226,
- life-cycle 1, 3, 4, 5, 105, 111, 134,  
135, 144, 169
- nuclear family 2
- Huéscar 27, 30, 224
- Iberian kingdoms 8, 9, 27, 44, 48,  
56, 107, 114, 119, 165
- Iberian peninsula 7, 26, 40
- Inés de Paz Marmolejo* 68
- Inquisition 41, 42, 49, 57, 75, 97,  
110, 111, 176
- Alto Tribunal* 51
- autos de fe* 52, 76
- crucesignati* 79

- declaration 63, 74  
*familiaturas* of the *Santo Oficio* 51, 56, 58, 63, 68, 73, 79, 88, 97, 101, 224  
*inquisidor* 51, 97, 111  
 interrogation 61, 62–3, 72–3, 74, 77, 93, 94  
*penitenciado* 63  
*relajado* 75  
*sambenitos* 74, 75  
*Santo Oficio* (Holy Office) 41, 49, 50, 51, 52, 53, 56, 57, 58, 63, 74, 75, 76, 78, 79, 88, 97, 98–100, 176, 183  
*Tribunal de Fe* (Court of Faith) 48  
 Isabella 30, 110  
 Islam 13, 17, 23, 24, 27, 29  
     Muslim 13, 17, 23, 26, 27, 28, 29, 30, 31, 40, 42, 169, 222, 223  
 Italy 10, 32, 33, 43, 108, 116  
  
 James I 12, 54  
 James II 9, 13, 14  
 Jerez de los Caballeros 57, 75  
 Jews 40, 46, 47  
     Abbedey 67, 75, 76  
     *judaizar* (Judaising) 41, 48, 57, 78  
     *judeizantes* 57  
     *judeoconverso* 46  
     *Ley de Moisés* 67  
 John I 19, 25, 26, 222  
 John II 22, 28, 107  
 Jordán 63  
*juntas* 136  
 Junterón 21  
*jurado* 15, 50  
*juros* 191  
     annual *juros* 191  
     *juro de heredad* 89, 92  
     *juros* and *censos* 295  
  
 kingdom of France 10, 54  
 kingdom of Granada 13, 17, 22, 23, 26, 27, 32, 52, 169, 222, 223, 224  
     conquest of Granada 13, 27, 29, 30–2, 33, 109, 169, 222, 223–4  
  
     Nasrid 13, 27, 169, 222  
 kingdom of Murcia 1, 2, 3, 7, 9, 11, 12–13, 14, 15, 16–17, 22, 23, 25, 26–7, 31, 41, 42, 43, 44, 48, 54, 58, 106–7, 109, 110, 111, 112, 113, 120, 178, 221, 222, 223  
 kingdom of Valencia 84, 85, 98, 191  
 knight 9, 11, 13, 14, 23, 24, 32, 33, 43, 62, 81, 85, 94, 110, 120, 183, 195, 207, 222  
*caballesc* 23, 24  
*caballeria* 23  
*caballeria popular* 24  
*caballeria villana* 24  
*caballerizo* 56  
*caballeros cuantiosos* 25, 222  
*padrón de cuantiosos murcianos* 25  
  
 La Sagra 27  
 land 7, 8, 10, 11–13, 14, 17, 20, 22, 23, 24, 25, 27, 29, 31, 32, 33, 128, 134, 153, 154, 164, 169, 173, 174, 175–6, 177–8, 179, 180, 182, 188, 190, 198, 200, 203, 205, 206, 209, 211, 220, 222, 224–5  
*donación* (donation) 7  
 land property 13, 40, 134, 169  
 landowner 22, 31, 168, 169, 170, 176, 224  
 landownership 9, 13, 24, 52, 56, 109, 120, 128  
 landowning nobility 9, 13, 112, 169, 178, 224  
  
 Laras 48, 51  
*las Partidas* (Divisions) 8  
*licencia real* 167  
*licenciado* 190, 207  
 lineage 2, 3, 4, 6, 7, 8, 9, 10–11, 12, 13, 14, 15–16, 17, 19, 21–2, 23, 24, 25, 27, 28, 29, 30, 31, 33, 34, 38, 40, 41, 42, 43, 44, 45, 46, 47, 48–9, 50, 51, 53, 54, 55, 56, 57–8, 63, 68, 69–71, 73, 74, 75, 76, 78–9, 80, 81–4, 86, 92, 101, 104, 106–7, 108, 109, 110,

- 111, 112, 113, 114–20, 121–2, 128, 159, 162, 164–5, 166, 168, 169–70, 175, 177, 179, 180, 182, 183, 187, 190, 192, 200, 204–5, 206, 207, 208, 209, 211, 213, 218, 220, 221–2, 223–4, 225, 226, 227
- genealogy 5, 14, 38, 59, 75, 85, 102, 104, 116, 118, 197, 214, 216, 218
- generations 113, 114, 115, 116, 118, 169, 182, 191
- linaje-patrón* 49, 50, 51
- memorials 31, 44, 223
- pariente mayor* 165, 204
- potestad* 204
- segundones* 166, 168, 203, 204–5, 206, 211, 226
- Llerena 57, 67, 73, 75
- longue durée* 4, 159, 221
- Lorca 9, 21, 23, 27, 28, 30, 169, 173, 176, 179, 224
- Lugartenencias* 112
- Maczak, A. 22
- Madoz, Pascual 209
- Magán 21
- Málaga 191
- Manuel and the Fajardo (lineages) 19, 21, 22
- Maravall, J. A. 41
- marine 86
- Marmolejo 68, 73, 76
- marquis of Pliego 191
- marquis of Vélez 45, 50, 55
- marquis of Villanueva del Río 192
- marquise of Pinares 277
- Martínez Silíceo 40, 47
- Martínez Silíceo statutes 41, 45
- Mauss, M. 54
- Melgarejo 55, 56, 83, 85, 114, 194, 195, 198, 200, 207
- Mergelina, Juliana 120
- Mérida 57, 88
- microhistory 1, 5, 6, 135
- Middle Ages 7
- military orders 68, 79–80, 83, 84–5, 110, 111, 224
- Order of Alcántara 42, 79, 84
- Order of Calatrava 42, 79, 84
- Order of Montesa 42, 79, 84, 85
- Order of San Juan 33, 42, 79, 84
- Order of Santiago 15, 29, 42, 62, 79, 80, 84, 107, 111
- monastery 190
- Monasterio de Monjas de Nuestra Señora de la Paz 76
- Moratalla 28, 43
- Muñón 21
- Muñoz de Robles, Juan Pedro 52, 178, 180, 183, 207, 208
- Muñoz family 52–3, 182
- Naples 33
- Netherlands 6
- oligarchy 1–2, 3, 13, 15, 17, 19, 20, 22, 24, 33, 34, 46, 51, 52, 53, 54, 55, 63, 68, 75, 76, 80, 93, 95, 98, 101, 105, 106, 110, 113, 114–15, 128, 135, 136, 144, 158, 159, 165, 166, 169, 171, 176, 178, 179, 180, 183, 191, 203, 204, 208, 220, 222, 224, 225, 226, 227
- bourgeoise 52
- gente nueva* 25
- old nobility 13, 16, 21, 24, 46, 223
- patriciado caballeresco* 24
- Spanish elite 116
- Ordenamiento* of Alcalá 24
- Orihuela 9, 85, 191, 192
- Owens, J. B. 45
- Pagáns 48, 114, 152
- paje* 30, 33, 61
- parcels
- Albadel 12
- albar* 12
- Alfande 12
- almarjal* 12
- alquería* 12
- Beniazor 12
- Benicomay 12
- Benicot 12



- Beninaya 12  
*celemines* 20  
*cuadrilla* 12  
*tahúllas* 12, 14, 198  
 parish of San Bartolomé 119  
 parish of San Miguel 84  
 parish of San Sebastián 56  
 parish of Santa Ana 58  
 parish of Santa Catalina 58  
 parish of Santa Justa y Rufina 192  
 parish of Santa María 203  
 Paz, Rodrigo 65  
 Paz family 56, 59–60, 63, 64, 67, 68,  
 73, 74–5, 76, 102, 191  
 Perez, J. 30  
 Peter I 16  
 Philip II 34, 51  
 Philip III 89  
 Philip IV 79, 84, 89  
 Philip V 84,  
 Pliego 191  
 Polizena Espinosa y de Paz, Ana 62  
 Ponce 21  
 Portugal 1, 8, 25, 26, 30, 57, 67,  
 164  
*presbítero* 58, 74  
*presbítero vicario* 74  
*Procurador de Cortes* (*procurador in*  
*court*)  
*procurador síndico general* 89  
*procuradurías* 225  
 Protestant Europe 135  
 Lutheran 93  
 Protestant reform 40, 45  
 Puebla de Don Fadrique 119  
 pure blood 31, 53, 67, 74, 179,  
 180  
*deuda de sangre* (debt of blood)  
 41  
*estatutos de limpieza de sangre*  
 (purity of blood statutes) 40,  
 41, 47, 49, 53, 57  
 impurity of blood 51, 73, 79  
 purity of blood 40, 41, 45, 47, 80  
 sangre divinal (divine blood)  
 46  
 Puxmarín 55, 83, 85  
*Real Cédula* 209  
*Real Sociedad Económica de Amigos*  
*del País* 119  
*Reconquista* (Reconquest) 2  
*Poema de Mío Cid* 23  
*regidores* 15, 19, 20, 21, 34, 37, 44,  
 89, 94, 95, 101, 107, 136, 158,  
 226–7  
 public office 15, 16, 34–7, 41,  
 48, 49, 50, 63, 76, 92, 221, 223,  
 225  
*regidores perpetuos* 22  
*regidurías* 15, 17, 19, 20, 22,  
 25, 34, 46, 47, 48, 51, 76, 79,  
 89–90, 91, 95, 223, 224, 225  
*regimiento* 16, 19  
 religious orders 80  
 Renaissance 41, 42, 49  
 Ricote 30  
 Riquelme, Alonso 28, 107, 108, 183  
 Riquelme, Bernardo 22, 86  
 Riquelme, Cristóbal (third lord of  
 Santo Ángel) 33, 175, 176, 205  
 Riquelme, Diego 22, 28, 29, 31,  
 108, 110, 113, 169, 207, 209,  
 211, 212  
 Riquelme, Francisco 18–19, 21, 22,  
 26, 27, 48, 107  
 Riquelme, Guillén 9, 11, 13, 14,  
 117  
 Riquelme, Juan 18, 20, 22, 26  
 Riquelme, Juan ‘*el viejo*’ 18  
 Riquelme, Martín ‘*el soldado*’ 33  
 Riquelme, Martín ‘*el valeroso*’ 30,  
 108, 109–10, 111, 113, 134  
 Riquelme, Petronila and Baltasar  
 Fontes 117–18  
 Riquelme de Arróniz, Cristóbal  
 (third lord of Santo Ángel)  
 80, 117, 170, 171, 173, 205,  
 207  
 Riquelme de Barrientos, Lorenzo  
 113  
 Riquelme de Comontes, Alonso  
 (second lord of Coy) 80, 109  
 Riquelme de Comontes, Diego  
 (third lord of Coy) 49, 178,  
 179, 205, 207

- Riquelme Salafranca y Rocha,  
Bernardo 86, 88, 89, 94, 208–9
- Riquelme y Avilés, Luis (fifth lord  
of Santo Ángel) 80, 205, 207
- Riquelme y Fontes, Jesualdo 94,  
118, 119, 120, 209, 212
- Riquelme y Togoires, Joaquín 92,  
93, 118, 119, 120
- Riquelmes 42
- Riquelme lineage 7, 10, 11,  
12–13, 19, 21–2, 28, 33, 38, 41,  
45, 48, 50–1, 53, 54, 55, 56, 78,  
80, 81–2, 83–4, 104, 106, 107,  
109–11, 112, 113, 114, 116,  
117, 119, 121–2, 142, 143, 169,  
175, 179–82, 183, 190, 205,  
207, 209, 211, 213, 218, 220,  
221–2, 224
- Robles-Muñoz 52
- Rocamora 83, 191, 192, 208
- Rocha 278
- Roda 63
- Rodríguez de la Centena,  
Francisco 63
- Rodríguez de Navarra y Mergelina,  
Alonso 120
- Saavedra Fajardo, Diego 56  
*Empresas Políticas* 56
- Salafranca 83, 86, 207, 208, 209,  
213, 214
- Salafranca, Gaspar 86
- Salamanca 59, 76, 80, 101
- Salucio, Agustín 47
- San Clemente de la Mancha 118
- San Nicolás de Bari 192
- Sánchez de Bolaños Maraver,  
Gonzalo 58
- Sánchez Manuel, Juan 16, 19, 21
- Sancho IV 13, 24
- Sandoval 63, 220, 226
- Santa Clara la Real 128
- Santesteva-Lara family 46
- Santo Ángel 23, 29, 30, 33, 49, 80,  
81, 117, 169, 170, 171, 173,  
174, 176, 177, 205, 207, 224
- scribe 75, 154, 179, 225  
*escribanías* 46
- escribano mayor* 52
- secretary 46, 52, 97  
*secretarías* 46, 225
- Segovia 111
- Segura river 11, 169, 173  
*moreras* (mulberry trees) 198  
orchard 12, 13, 23, 169, 222  
*señoríos* (land property) 13, 23,  
29, 169  
*estado señorial* 168  
*señores del agua* 169  
*señorialización* 13  
*señorío* of La Ñora 109
- Serrano y Molina, Luisa Robles  
118
- Seville 47, 74, 190, 191
- social homogeneity 109, 116  
biological stagnation 120, 168,  
226
- social mobility 46, 128, 223  
assimilation 15, 24, 46  
*títulos blancos* 278
- social network 3–4, 5, 16, 55,  
105–6, 110, 115, 134, 135–6,  
142, 143, 154, 155, 159, 220,  
225, 227  
*allegados* 4, 134, 152, 225  
alliance 4, 8, 13, 15, 18, 21, 25,  
43, 51, 55, 84, 105–6, 108, 110,  
111–12, 114, 115, 116, 119,  
120, 135, 165, 178, 183, 225
- commerce networks 134  
*compadrazgo* 144, 226  
godfather 67, 226  
godparents 135, 144  
*paisanaje* 4, 6  
*parentela* 164, 165
- Society of Jesus 76
- Sotos 42
- Soto lineage 30, 34, 46, 48, 51
- Suárez Fernández, Luis 16
- Tarifa 24,
- Toledo 40
- Torrellas sentence 13
- Trastámara dynasty 14, 16  
Trastámara revolution 16  
*trastamarista* nobility 16

- United Kingdom 6  
 Urban IV 97  
  
 Valcárcel 83  
 Valibreras 48, 49  
 Valladolid 168, 190  
 valley of Almanzora 27  
 Vatican 116  
     Papacy 29, 32, 52  
 Verástegui 55, 114  
     *vicaría* 74  
 Villagomez de Comontes, Aldonza  
     113  
 Villena Marquisate 120  
     *vizconde* of Alguazas 55  
  
 will 84, 135, 166, 168, 171, 179,  
     198, 220  
     *cobdiculo* 180  
  
     *legítima* 165  
     *libre disposición* 165, 166  
     *mandas pías* (pious mandates)  
         190  
     *mejora* 165, 166, 175, 179  
     testament 195  
  
 Xiquena 27  
  
 Yáñez Fajardo, Alonso 16, 18, 19,  
     21, 22, 27, 43, 107, 113, 261  
 Yáñez Fajardo, Alonso  
     ‘*el africano*’ 31  
 Yáñez Fajardo II, Alonso 22,  
     26, 27  
  
 Zafra 57  
 Zarandona 220, 226  
 Zúñiga 208, 210

'Persuasive, convincing and complex, *Blood, Land and Power* focuses on the journey of the Murcian Riquelme family between the thirteenth and eighteenth centuries, and offers an exciting insight into the multiple dimensions required for the *longue durée* survival of the noble elites in southern Europe. Placing family dynamics at the centre of the analysis, Manuel Perez-Garcia explores analytical categories such as lineage, purity of blood, honour, social networks and *mayorazgo*. The talent and art revealed in the treatment of historical sources transform this attractive case study into a general model for understanding the multilayered Spanish nobilities.'

*Profesor Mafalda Soares da Cunha, University of Évora*

The analysis of land management, lineage and family through the case study of early modern Spanish nobility from sixteenth to early nineteenth century is a major issue in recent historiography. It aims to shed light on how upper social classes arranged strategies to maintain their political and economic status. Rivalry and disputes between old factions and families were attached to the control and exercise of power. Blood, land management and honour were the main elements in these disputes. Honour, service to the Crown, participation in the conquest and 'pure' blood (Catholic affiliation) were the main features of Spanish nobility. This book analyses the origins of the entailed-estate (*mayorazgo*) from medieval times to early modern period, as the main element that enables us to understand the socio-economic behaviour of these families over generations. This *longue durée* chronology within the Braudelian methodology of the research aims to show how strategies and family networks changed over time, demonstrating a micro-history study of daily life.

MANUEL PEREZ-GARCIA is tenured Associate Professor in the Department of History, School of Humanities, at Shanghai Jiao Tong University in China, and is founder and director of the Global History Network in China (GHN). He is Principal Investigator of the Global Encounters between China and Europe (GECHEM) Project, funded by the European Research Council under the European Union's Horizon 2020 Research and Innovation Programme.

Cover image: Francisco Pradilla Ortiz, *The Capitulation of Granada* (1882), oil on canvas, coll. Senado de España, Madrid; by permission, Heritage Image Partnership Ltd / Alamy Stock Photo.

[www.uwp.co.uk](http://www.uwp.co.uk)



GWASG PRIFYSGOL CYMRU  
UNIVERSITY OF WALES PRESS

ISBN 978-1-78683-710-3



9 781786 837103 >