

Jean-Pierre Jeannet
Thierry Volery
Heiko Bergmann
Cornelia Amstutz

Masterpieces of Swiss Entrepreneurship

Swiss SMEs Competing in Global Markets

OPEN ACCESS



Springer

Masterpieces of Swiss Entrepreneurship

Jean-Pierre Jeannet • Thierry Volery •
Heiko Bergmann • Cornelia Amstutz

Masterpieces of Swiss Entrepreneurship

Swiss SMEs Competing in Global
Markets

 Springer

Jean-Pierre Jeannot
IMD
International Institute for Management
Lausanne, Vaud, Switzerland

Thierry Volery
Department General Management
ZHAW School of Management and Law
Winterthur, Zürich, Switzerland

Heiko Bergmann
KMU-HSG
University of St. Gallen
St. Gallen, Switzerland

Cornelia Amstutz
University of Lucerne
Lucerne, Switzerland



ISBN 978-3-030-65286-9 ISBN 978-3-030-65287-6 (eBook)
<https://doi.org/10.1007/978-3-030-65287-6>

© The Editor(s) (if applicable) and The Author(s) 2021, This book is an open access publication.

Open Access This book is licensed under the terms of the Creative Commons Attribution 4.0 International License (<http://creativecommons.org/licenses/by/4.0/>), which permits use, sharing, adaptation, distribution and reproduction in any medium or format, as long as you give appropriate credit to the original author(s) and the source, provide a link to the Creative Commons license and indicate if changes were made.

The images or other third party material in this book are included in the book's Creative Commons license, unless indicated otherwise in a credit line to the material. If material is not included in the book's Creative Commons license and your intended use is not permitted by statutory regulation or exceeds the permitted use, you will need to obtain permission directly from the copyright holder.

The use of general descriptive names, registered names, trademarks, service marks, etc. in this publication does not imply, even in the absence of a specific statement, that such names are exempt from the relevant protective laws and regulations and therefore free for general use.

The publisher, the authors, and the editors are safe to assume that the advice and information in this book are believed to be true and accurate at the date of publication. Neither the publisher nor the authors or the editors give a warranty, expressed or implied, with respect to the material contained herein or for any errors or omissions that may have been made. The publisher remains neutral with regard to jurisdictional claims in published maps and institutional affiliations.

This Springer imprint is published by the registered company Springer Nature Switzerland AG.
The registered company address is: Gewerbestrasse 11, 6330 Cham, Switzerland

Foreword

Masterpieces of Swiss Entrepreneurship

You are holding a very special book in your hands, a singularly unique treasure for entrepreneurs. Never before was there such a concentration of practical learning based upon entrepreneurial practices. Exciting background information on 36 small and medium-sized (SME) companies across all of Switzerland focused on the central question why, and how, these SMEs managed to survive for such a long time, and to be successful at the same time.

I have had the pleasure of meeting Prof. Jeannet, the project leader and lead author for this book, on several occasions over the past 20 years, and could experience his exceptional talent. Whether at his institutional homes, Babson College in the USA, at IMD Institute in Lausanne, or at the Swiss Economic Forum, we were both fascinated by and shared a common interest in entrepreneurship. To combine the conceptual with practical experience was always his passion and his very personal USP. He managed to engage a team of coauthors who obviously shared the same interests. Together they recruited a group of talented researchers to assist, and to energize them to engage in a field-based project to extract so far little known findings. These findings are now offered by the team as conceptualized experience with great value added.

The firms selected for inclusion in this book have withstood the test of time. They have adjusted successfully to changed economic circumstances and on numerous occasions had to overcome crises in their markets. The selection of companies covers all of Switzerland and represents the most important industry sectors. The established firms have existed for decades; the oldest one can look back on almost 190 years of uninterrupted industrial activity. By focusing on export-oriented manufacturers, the book captures companies with high value added. These companies are major contributors to the exceptionally high export contribution of 66% to Switzerland's domestic economy and represent major pillars of its economy.

Why do I recommend *Masterpieces of Swiss Entrepreneurship* to my best business friends? The high degree of practice orientation makes the difference for me. Thanks to the personal interviews of many owners and managers of the

companies featured, the authors managed to add deep insights to their collected data and in-depth analyses. Based upon my own experience personally visiting some 1500 SMEs and startup companies in Switzerland, I can assure you that this book with its findings and insights will make equally valuable reading for young entrepreneurs starting out as well as for seasoned professional managers. Experienced decision makers, be they managers or advisors, will also profit from the insights offered.

Let yourself become fascinated and inspired by the very different pathways to success and strategies that have stood the test of time. *Masterpieces of Entrepreneurship* will allow you to approach your daily challenges with more serenity and thus more effectively master them. I can guarantee you an interesting read with a multitude of entrepreneurially relevant treasures!

Extending entrepreneurial greetings to all.

Swiss Entrepreneurs Foundation
Bern, Switzerland

Peter Stähli

Foreword

Masterpieces of Swiss Entrepreneurship

“Masterpieces” is especially interesting and important to me as an entrepreneur and educator. In my professional life at the intersection of enterprise creation and management in both private and public companies, and as a professor and College President, I often seek the wisdom of fellow entrepreneurs and executives, attempting to translate their experiences into lessons that might help me become better at my professions. This book eloquently captures that process. It not only details the company stories to provide important and actionable learning, it also combines the stories into a tapestry of entrepreneurship education akin to a highly condensed curriculum that can be reviewed time and again.

I have never read a more sophisticated analysis of entrepreneurial dynamics. In a rapidly changing environment, the ability of the entrepreneur to adroitly manage is essential. The authors apply rigorous scholarship that mines the professional wisdom of companies, entrepreneurs, and managers. The richly woven lessons articulate the path to success and lasting value creation.

The practices and lessons derived from their stories, based upon rigorous field research into 36 company profiles, become accessible lessons for entrepreneurs to understand and to apply to their enterprises. The stories of struggle, of understandings, and of success are made into intellectual capital that stands the test of time. It is clear to me that SMEs will gain valuable insights, but there is much wisdom for the larger firm as well.

“Masterpieces” makes these lessons real and interesting through the many wonderful stories around company leaders. Rigor of sophisticated scholarship combined with the power of personal experiences is the essence of the “entrepreneurial thought and action” paradigm we foster at Babson College. Indeed, “Masterpieces” will motivate the reader to think more deeply and act more decisively.

While this is a study in the context of the magnificent Swiss economic ecosystem, I believe it applies to a broader set of communities. The authors have studied the entrepreneurial practices of a carefully chosen set of companies that represent the growth and development of high margin industries over the long run. The durability

of the entrepreneurial behaviors described in this book adds great value to the learnings.

Entrepreneurs, executives, scholars, policy makers, and educators all need to read *Masterpieces of Swiss Entrepreneurship*.

Babson College
Babson Park, MA, USA

Stephen Spinelli

Acknowledgments

Given the scope of this project, a team of four could not have undertaken and completed it within a reasonable time frame without significant assistance and support from a large number of individuals and institutions.

First and foremost, the research project leading to the publication of this book hinged on the generous and active support of the 36 SMEs whose owners and managers agreed to participate and be interviewed. They generously shared their valuable time and insights allowing us to move beyond published information. We also benefited from their willingness to have material checked and published, and to make company visuals available to enhance the understanding of the company profiles. We are most grateful for their generosity, which made it possible that the resulting publication could be relevant to the continued success of other SMEs operating in Switzerland, and beyond.

We owe an enormous debt of gratitude to the institutions and foundations which supported this project financially and thus paved the way for having it presented in the form of a printed book. The Göhner Foundation took the lead and helped us with initial funding. The Swiss Venture Club provided the project with a significant contribution that also opened doors to many companies. To ensure that this research could be published in open access format as well as a printed book, we again owe a debt of special gratitude to the Swiss Venture Club and Credit Suisse, with Didier Denat taking the lead. Additional funding was provided by private sources. This generous support allowed the research to go forward and for the team to approach participating companies without any additional funding, thus strengthening the independence of the authors in the selection of companies.

Significant non-financial support was provided by a number of institutions and individuals. Renaissance Foundation, and in particular its partners and chairman, played a key role in encouraging this project to go forward. Christian Waldvogel was the first to suggest we undertake this project. Claude Suard contributed valuable contacts for the team to gain access to SMEs, and Xavier Paternot provided for several parts of this material to be road-tested in their annual Swiss Entrepreneur and CEO Forum. And finally, Andreas Giesbrecht introduced the project to the SVC Foundation from whom we could secure the bulk of our financial support.

We are also indebted to a number of educational institutions who supported this project through logistical, administrative, and research support. The University of

St. Gallen and the University of Lucerne were the source for students who provided important research assistance. Additional research support was obtained through HEG Fribourg. And BNF Foundation provided us with the first set of researchers to get the project off the ground.

We greatly benefited from people who provided key contacts and recommended us to target firms, thus opening doors for us. Aside from the partners at Renaissance, we benefited from support by Michael Fahrni at Swiss Venture Club, Martin Follini, Ernst Thomke, Fritz Fahrni, Konstantin v. Schulthess, and Roger Graber, who all paved the way for us to interview many of the 36 SMEs represented in this research.

In the early phase of the project, we were supported by the BNF Foundation through whom we recruited our first research assistants, Marlon Jaun and Araya Tesfalidet. It was Marlon Jaun who created the database structure for our research, and who later on also instructed the students of St. Gallen and Lucerne in how to use it. This ensured that we could collect our information along a similar structure, greatly contributing to the comparability of our analyses.

The findings presented in this book required an extensive initial research effort sifting through publicly available information. The diligent work of a large number of students who prepared preliminary versions of the company profiles and supported our analysis was a critical contribution to this project.

At the University of St. Gallen, we were supported by Svenja Barth, Jennifer Dussileck, Haxhere Haliti, Visar Hamzai, Nick Huber, Nico Kueng, David Wyss, and Edouard Zeller. At the University of Lucerne, support came from Fabian Schillig and Alessia Togni. Through HEG Fribourg we were able to recruit Esperança Alves Gonçalves, and Aimee Szczesny contributed from Murdoch University. These university students often traded research support for access to data for their own bachelor's or master's thesis. At IMD Institute, Vincenzo Palatella and Ivana Ramos contributed to a number of our charts and exhibits.

Finally, we are indebted to a number of colleagues at IMD and HEG Fribourg, as well as our main sponsors SVC Foundation and Renaissance, who reacted to earlier versions of our text and provided valuable feedback to improve the organization of this book.

Last but not least, we owe a great debt of gratitude to our editors, Anita Hussey and Christine Jeannet, whose work improved both the logic and the wording of our text and company profiles.

Endorsements

“*Masterpieces of Swiss Entrepreneurship* brings unique learning opportunities to owners and leaders of SMEs in Switzerland and elsewhere. Findings are based on detailed bottom-up research of 36 companies—without any preconceived notions. The book is both conceptual and practical. It fosters understanding for different choices in development pathways and management practices.”

—Matti Alahuhta, *Chairman DevCo Partners, ex-CEO Kone, Board member of several global listed companies, Helsinki, Finland*

* * *

“This book offers a well-documented view of long-term success factors of Swiss SMEs, taking a comprehensive view of their management practices. Analyzed are individual firms, as well as patterns across the entire set of firms. Shown are the development of successful strategies with a strong connection to management practice. The book adds value to SME owners and managers well beyond Switzerland.”

—Prof. Dr. Hermann Frank, *WU (Vienna University of Economics and Business)*

* * *

“The authors have spent years studying 36 Swiss SMEs that have been ‘punching above their weight’ for many years. Beyond the unique individual trajectories, these companies have been following a few practices that all leaders—regardless of company size—can learn and benefit from.”

—Jean-François Manzoni, *President IMD, Lausanne, Switzerland*

* * *

“This is a remarkable book. It does a masterful job of telling and reflecting about the stories of closely held companies that have had a lasting impact in their industries and their wider social context. Instead of proposing a ‘one-size-fits-all’ list of success factors, it gives space to the heterogeneity and uniqueness of the companies studied. I highly recommend this book.”

—Thomas Zellweger, *Professor of Management, University of St. Gallen*

* * *

“Startup entrepreneurs need proven models from industry which demonstrate the various paths to success. *Masterpieces of Swiss Entrepreneurship* provides deep insights highlighting these models and the important trade-offs entrepreneurial teams must consider when choosing the path of high growth or of maximum control, as they are often mutually exclusive.”

—Gina Domanig, *Managing Partner, Emerald Technology Ventures, Zurich*

Contents

Part I Introducing the Project

1	Introduction	3
	Undertaking the Project	3
	Genesis of This Project	4
	Chasing a “Big Idea”	4
	Recruiting a Team of Like-Minded Researchers	5
	Selecting a Research Design Fit to Purpose	5
	Identifying Firms to Research	6
	Establishing a Long List	7
	Selecting a Convenience Sample	7
	Creating a Company Specific Database	7
	Conducting and Documenting Interviews	8
	Compiling Company Profiles	8
	Requesting Fact Checks	9
	Performing Pattern Analysis	9
	Analyzing Management Practices	10
	Compiling Company Profiles	10
	Clustering Growth Trajectories	11
	Reflecting on Impact of Swiss Entrepreneurship Ecosystem	11
	How to Read This Book	12
2	Founders, Shakers, Prime Movers	13
	Who Were Those Guys?	13
	Founders from the Early Period	16
	Founders from the Interwar Period (WWI to WWII)	17
	Founders Creating Businesses During WWII	17
	Founders from the Post-WWII “Baby Boomer” Generation	18
	Founders from the More Recent Era	20
	Differentiating Between Prime Movers and Founders	21
	Reflecting on the Background of Founders	21
	And Women?	22

Part II Governance Practices

3	Ownership Structures	27
	Ownership Structures for Stability and Control	27
	From Single Ownership to Family Company	28
	Family Ownership for the Long Term	28
	Owned by the Same Family Over Multiple Generations	29
	The Effort to Keep the Business Within the Family	30
	How Two Families Preserved Combined Ownership for the Next Generation	30
	Passing Ownership from One Family to Another Family	31
	Passing Ownership Through a Succession of Three Different Families	31
	Going Public to Assure Succession	32
	Employing Shareholder Agreements to Provide Stability	32
	Assuming Founding Partner Stakes to Provide Stability	33
	MBOs to Recruit New Owners	34
	Reflections on Ownership Models	35
4	Achieving Ownership Stability	37
	Stability Through Foundations	37
	Stability Through Private Investors	38
	Employees Riding to the Rescue	39
	Stability as Public Company	40
	When Ownership Stability Fails	43
	Independence Versus Autonomy	45
5	Boards and Governance	47
	Governance Arrangements	47
	Board Composition at Public Companies	47
	Board Roles in Family-Owned Companies	49
	Board Role in Foundation-Owned Companies	50
	Emergence of Dual Board Structure	51
	Board Structures at Investor-Driven Companies	53
	Evolving Role of Boards	53

Part III Managing for the Long-Term

6	The Role Played by Management	57
	Owner-Manager Versus Professional Manager Models	57
	Multi-generation Owner-Managed Firms	57
	First Generation Owner-Managed Firms	59
	Second Generation Owner-Managed Firms	59
	Challenges of Sticking with Owner-Manager Model	60
	Separating Ownership and Management	61
	The Challenge of Recruiting Successors	63
	Practicing a Unique Management Style	65

7 Financing the Enterprise 69
 Frugal Beginnings Predominate 69
 Starting Up in Garages and Old Factory Buildings 69
 Tapping into Personal and Family Savings 70
 Bootstrapping Mentality 71
 Leveraging External Investor Resources 73
 Utilizing Leveraged Financing 74
 Financing Current Business 74
 Relying on Cash Flow and Internal Sources 75
 Adopting Conservative Financial Policies 77

Part IV Focus Choices

8 Business Focus Choices 83
 Focus Comes in Different Forms 83
 Focusing on a Single Industry 83
 Experience Leading to Business Focus 84
 Focusing Around Core Competency 86
 Pursuing a Technology Focus 87
 Focusing on a Single Market 89

9 Franchise Focus Choices 93
 Focusing on a Customer Franchise 93
 Building a Customer Franchise Around Industries 93
 Building a Customer Franchise Around Institutions 94
 Building a Customer Franchise Around Professional Groups 96
 Adopting a Solution-Based Customer Franchise 98
 Employing a System-Centered Approach 99
 Consumer Franchise Focus 100

10 The Process of Focusing 101
 Focus Does Not “Just Happen” 101
 Finding Focus Is a Journey 101
 Employing Multiple Layers of Focus 103
 Reaping the Benefit of Focus 104
 Lessons from Focus Journeys 105

Part V Marketing Practices

11 Segmentation Choices 109
 Segmenting Markets and Selecting Segments 109
 Defining and Segmenting Market Space 109
 Subsegments to Define Target Customers 111
 Playing the Product Features Game 113
 Targeting Multiple Segments 113
 Market vs. Technology Segments 115

Selecting Quality and Premium Price Segments	116
Moving into High-Volume Segments	117
Niche-Within-Niche Segments	118
Organizing Around Segment Choices	119
Observations on Segmenting	119
12 International Sales and Distribution Strategies	121
Early Pioneers of International Expansion	121
Relying on Distributors and Agent Networks	123
Building Distribution Partnerships	125
Creating Subsidiary Networks	127
Market Entries Around Manufacturing Acquisitions	129
Cracking Difficult Markets	130
Managing Changes in the Distribution Channel	132
Reflections	133
13 Marketing and Sales Processes	135
The Marketing vs. Sales Debate	135
B2C SMEs Engaging in Global Brand Building	135
Professionalizing the Marketing Process	138
It’s All in a Name	139
Marketing and Selling in a B2B Environment	139
Application-Driven Sales	140
Employing Key Account Systems	141
Global Sales Practices in the Medical Cluster	142
The Importance of Lead Customers	143
Review	147
 Part VI Product Building Choices	
14 Production Footprint Choices	151
Exclusively Swiss-Based Production	151
Modified Swiss Manufacturing	153
Swiss and International Production	154
Globally Distributed Production	156
Offshoring Production Capacity	161
Colocating Production	162
15 Production Processes Choices	165
The Role of Proprietary Processes	165
Designing Proprietary Production Lines	165
Building Custom Equipment	167
Installing Automation and Robotization	168
Capitalizing on Long-Term Improvements	170
16 Product Design Choices	171
Designing for Durability	171

Designing with Flair	172
Ergonomics, Broadly Defined	172
Design Thinking by Tradition	175
17 Product Line Choices	177
Adopting Modularization Strategies	177
Employing Platforming Strategies	178
Combining Modularity with Platforming	180
18 Supply Chain Choices	183
Models of Supply Chain Integration	183
The Integrators	184
The Partial Integrators	186
The Assemblers	187
The Fables Two	189
Reflections	190

Part VII Innovation Practices

19 Sourcing the Defining Business Idea	195
The Defining Idea	195
Leaving Unresponsive Employer	195
Capitalizing on Personal Experience	198
Walk-Ins as Innovation Sources	199
Power of Customer Suggestions	204
Just Reading About It	204
Rejected Job Application	204
Exploiting Disruptions	205
Borrowing from Other Industries	207
Practicing the Open Mind Principle	208
20 Innovation Processes	211
Product Innovation Over the Long Haul	211
Reinventing at Regular Intervals	212
Product Platform Innovations	213
Innovating with Materials	215
Innovating Production Processes	216
Winning at the Innovation Game	217
21 Organizing for Innovation	219
Organizing for Perpetual Innovation	219
Creating an Innovation Assembly Line	219
Entering into Customer Partnerships	222
Business Model Innovations	226
Resting on Laurels Not Allowed!	229

Part VIII Leveraging Strategies

22	Leveraging Local Competitiveness	235
	Leveraging Local Resources	235
	Engaging in Premium Pricing	237
	Leveraging Core Competencies and Skills	240
	Leveraging Talent	242
	Recruiting Talent in Urban Centers	243
	Recruiting Talent to Rural Areas	244
	Growing Talent Internally	246
	Apprenticed Managers	248
	Leveraging Institutions of Higher Education	249
	Leveraging Entrepreneurship Among Employees	250
	Leveraging “Swissness”	251
	Leveraging Industry Clusters	253
	Swiss Framework Conditions	254
23	Leveraging Resources for Growth	257
	Different Strategies for Growth	257
	Differentiation Through Expansion Strategies	257
	Global Expansion Strategies	259
	The Role of M&A in Growing SMEs	261
	Decoding Drivers for Growth by Company Size and Age	265
	Examining Differences in Growth Patterns	266
	Clustering Companies by Development Trajectories	268
	Meeting the <i>Long-Distance</i> Runners	269
	Meeting the <i>Middle-Distance</i> Runners	269
	Meeting the <i>Sprinters</i>	270
	Meeting the <i>Steeplechasers</i>	270
	Who is in the <i>Starting Blocks</i> ?	271
	Size vs. Longevity	271
	Surviving Crises	272
	Courageous Bets for Growth	273
	Resurrected Companies	274
24	Role of Swiss Entrepreneurship Ecosystem	277
	Why This Chapter?	277
	Why So Many SMEs in Switzerland?	278
	Swiss Tradition of Entrepreneurship	278
	<i>Techne</i> vs. <i>Episteme</i> : A Wall Street Banker’s Observation	279
	Swiss Dual Education System	280
	A Knack for Engineering Ingenuity	281
	Tradition of Cooperative Governance	283
	A Deeply Rooted Work Ethic	285
	Swiss Management Philosophy	287
	Switzerland: Exception or Role Model?	288
	Reflections	289

25	Epilog: Implications for Public Policy	291
	Observations for Business and Managerial Community	292
	Observations for the Entrepreneurial Community	292
	Observations for Financial Community	293
	Observations for Consultants and Advisors	293
	Observations for the Educational Community	294
	Observations for Political and Governmental Community/ Public Policy	295
	Observations for Members of the Media	295
	Observations for Society at Large and Individual Citizens	296

Part IX Company Profiles

26	Company Profiles	299
	Company Profile 1: Sefar—A Big Business Based on Small Holes. From Cottage Weaving to Industrial Enterprise	300
	Business Founded in a Small Village	300
	Capitalizing on the Industrial Revolution Changing Grain Processing	301
	Internationalizing from the Start	301
	Widow Leading Company to New Heights	301
	Enter the Tobler Family	302
	Proceeding with a Great Merger	302
	Opening First Subsidiaries Abroad	303
	Changing the Production Model	303
	Adopting New Materials and Entering New Applications	304
	Engaging in a New Wave of Internationalization	304
	Focusing on B2B Markets	305
	Strengthening Innovation	305
	Attracting Human Resources	306
	Family-Owned vs. Family-Managed	306
	Company Profile 2: Burckhardt Compression—World Leader in Gas Compression. Thriving Regardless of Multiple Ownership and Location Changes	309
	From Small Workshop to Global Leader	309
	Starting a Small Workshop in Basel to Serve the Textile Industry	309
	Shift Toward an Industrial Company and Focus on Compressors	309
	Burckhardt Becoming Member of Sulzer Group	310
	Grabbing Opportunity for Leaving Sulzer Group MBO	311
	Tackling the Global Market for Compression	312
	Going for IPO	312
	Enlarging the Product Portfolio	313
	Growing the Manufacturing Footprint	313
	Enlarging the Service Footprint	313
	The Sales Footprint Centered on Switzerland	314

Maintaining Financial Flexibility	314
Management Principles Driving Burckhardt Compression	315
Governance at Burckhardt Compression	315
Company Profile 3: Geistlich Pharma AG—Global Leader in Regenerative Dentistry. From Production of Glue to Bone Regeneration over More than 100 Years	317
From Industrial Glue to Bone Regeneration	317
Beginning with Bone Processing	317
Taking First Steps into Pharma Space	318
Entering Regenerative Biomaterials	318
Shedding Legacy Businesses	319
Shifting from an Industrial to a Biomaterials Enterprise	319
Adapting the Business Model to New Realities	320
Segmenting Pharma into Business Units	321
Managing Geistlich	322
Governance at Geistlich	322
Company Profile 4: Sécheron Hasler Group—World Champion in DC Electrical Trains. Electric Power Systems for Traction and Energy	323
A Storied History in Traction Power and Energy	323
Surviving the First 90 Years	324
Brown Boveri (BBC) Acquired Sécheron in 1969	324
Regaining Independence Through Spin-Off 1990	325
Bankers to the Rescue	325
Transition Partners Taking Ownership in 2005	326
Initiating a Turnaround Exercise	326
Refocusing on Three Segments	327
Streamlining the Manufacturing Footprint	327
Generating New Sales Dynamics	328
Resourcing the Group	328
Owner-Managed Governance at Sécheron Hasler Group	329
Company Profile 5: Cendres + Métaux (C+M) SA—Global Specialist in Refining and Recycling of Precious Materials. From Supplying Materials to Micromechanical Competence	331
A Company Evolving Around Refining and Machining of Precious Metal	331
Beginning as a Refining Business Attached to a Pharmacy	331
Building a First Leg Serving the Watch and Jewelry Industry	332
Nurturing the Dental Market	333
Venturing into Contract Manufacturing	333
Innovative Excursions	334
Constantly Evolving C+M's Business Model	334
Internationalizing C+M	335
Using M&A to Expand C+M	336

Adapting Its Organizational Structure	336
Management and Governance	337
Company Profile 6: Lantal Textiles—Global Leader for Aircraft Interiors. From Cheese Cloth to Seat Covers	339
Beginning as a Linen Weaving Mill	339
Turning into Upholstery Weaving Mill	339
New Market Opportunity Opened by Chance	340
Moving into Ground Transport Sector	340
Establishing Subsidiary in the USA	340
Managing Multiple Production Technologies	341
Transferring the Company to New Ownership	341
Extending Value Added	342
Developing a Revolutionary Seat	342
Dual Strategy Targeting Both Budget and Premium Segments	343
Competing in a Volatile Industry	343
Reducing Dependence on Airlines	344
Nurturing a Unique Company Culture	344
Corporate Governance	344
Company Profile 7: Max Felchlin AG—Gold Medal Winner for the World’s Best Chocolate. Supplying the World’s Leading Pastry Chefs	346
From Honey Trading to Chocolate Couverture Master	346
Starting Out as Honey Trader	346
Refusal to Supply Felchlin Led to Entry into Chocolate Segment	347
Overcoming Difficulties During WWII	347
Second Generation Takes Over 1962–1992	347
Pursuing Global Market Expansion	348
Preparing Ownership and Governance Structure for Transfer to Third Generation	349
Finding Third-Generation Aschwanden	349
Felchlin Grand Cru Story	350
Creating a School for Chefs	351
Maintaining a Competitive Edge	351
Investing in the Future	352
Company Profile 8: Plumettaz SA—From Winching to Blowing Cables. World Champion in Cable Installation Equipment	353
The Cable Laying Experts in Bex (VD), Switzerland	353
At the Outset a Strong Urge to Become Independent	354
Prototyping as First Opportunity	354
1930s: Market Collapse Led to New Opportunities in the Nearby Vineyards	354
1940s: Emergence of Proprietary Capstan Winching Technology as the Core Know-How	355
First Export Business After WWII	355

Second Generation of Owners Brings Entry into the Circulating Pump Business	355
1950s: Plumettaz Develops a Tractor-Mounted Winch	356
Need to Respond to Decline of the Vineyard Market	356
The Land Rover Connection Proved to Be Very Important	356
A Man Arrives in a Rolls Royce	357
Entering the Telecom Cable Laying Business	357
Plumettaz Segment Selection Strategy Over Time	358
Plumettaz Sales and Distribution Strategy	358
Plumettaz Production Footprint Focused on Switzerland	359
Plumettaz Development and Engineering “Open Eye Principle”	359
Evolving Company Ownership and Governance	360
Company Profile 9: Caran d’Ache SA—Global Leader for Sophisticated Luxury Writing Instruments. Pencils for Most Luminous Colors	362
From Soap to High-Quality Pencils and Writing Instruments	362
The First Set of Founders Divested	362
Buyout and Relaunch	362
Adopting Caran d’Ache as a Company Brand Name	363
Bringing in New Investors	363
From Investors to Managers	363
Defining Market Space and Focus	364
Constantly Evolving the Product Line	364
Honing the Craft of Pencil Production	365
Differentiating Through Quality and Sustainability	366
Engaging in a Global Marketing Effort	366
Governance and Transition to Nonfamily Management	367
Company Profile 10: Kuhn Rikon AG—Cooking Up a Storm! Global Leader in Steam Pressure Cooking for Home Use	368
The Cooking Invention Turned into a Global Business	368
Heinrich Kuhn Acquires the Coppersmith Workshop in 1926	369
The Second Kuhn Generation Steps In	369
The Launch of the Duromatic Pressure Cooker	370
Developing Durotherm in 1975	370
Innovations Contributed by the Third Generation	371
Entry into the Kitchen Gadget Business	371
Difficult Experience with Acquisitions	372
Production Footprint	373
Building International Markets	373
Marketing Through Multichannels	374
Impact of Government Regulations on Swissness	374
Ownership and Governance at Kuhn Rikon	374
Company Profile 11: Ricola—From Local Confectionary to Global Herbal Candy Champion. From Hobby to Global Business	376

Started by a Young Entrepreneurial Baker	376
Leveraging Bakery and Confectionary Skills	376
Starting A Herbal Sugar Candy Business	376
Branding the Herbal Sugar Candy “Ricola”	377
Ricola’s Global Expansion	377
Nurturing the Ricola Brand	377
Focusing the Ricola Product Portfolio	378
Assuring Sufficient Herb Supplies	378
Dedicated Herb Processing Operations	378
Ricola Distribution and Logistics	379
Patrons of Arts and Architecture	379
Ricola Foundation	380
Ricola Remains a Family-Owned Business	380
Governance at Ricola	380
Company Profile 12: Jura Elektroapparate AG—From Generalist of Kitchen and Household Appliances to World Champion in Espresso Machines for In-Home Use in 75 Years. “The Best Cup of Coffee at the Press of a Button”	382
Started by a Single Entrepreneur	382
After a Disastrous Fire a Need to Start All Over Again	382
Origin of the Espresso Machine Opportunity	383
1982 to 1991: A New Team Takes Over	383
1991 to 2015: Period of Transformation	384
A Focus Strategy on Multiple Levels	384
Focusing the Product Line	384
Focus on In-Home Use as Target Market Segment	385
Focus on Selective Steps of the Value Chain	385
Controlling Design and Features	385
Perennial Innovation	386
Marketing and Branding: Building the “House of Jura”	386
Building Selective Distribution and Geographic Expansion	387
Intensifying Service and Jura World Exhibit	387
Stability in Ownership and Governance	387
Company Profile 13: Fraisa Group—Global Power in Metal Cutting Tools: Mill, Drill, and Thread Any Hard Metal	389
A Bankruptcy Leading to a New Opportunity	389
Turning into a Second-Generation Family Company	389
Developing a National and International Sales Network	390
Technology Shock Through Coating Technology for Tools	390
New Materials Causing the Next Disruption	391
Confronting Ownership Changes and Management Turmoil	391
Globalization Impacts on the Fraisa Distribution Model	392
Adoption of the New Business Model “ToolCare”	393
Globalization of Tool Producers Becomes Yet Another Threat	393

Global Developments Triggered a Management Buyout	393
Navigating the Financial Crisis of 2008/2009	394
Refocusing the Business Model	395
Constantly Evolving Its Manufacturing Footprint	395
Building an Extensive Service Footprint	396
Sales Footprint	396
Bringing Up New Talent	396
New Strategy for Resourcing and Financing the Company	397
Governance Experience at Fraisa	397
Company Profile 14: Filtrox—Global Leader in Depth Filtration.	
From Components to Systems and Back to Components	399
Founded in Troubled Times	399
Beginning Modestly	399
Mastering Depth Filter Production	400
Entering the Market for Filter Equipment	401
Capitalizing on Growth in Postwar Years	401
Globalizing Filtrox	401
Achieving Economies of Scale	402
Moving into New Application Segments	403
Confronting a Growing Divide	403
Deciding to Split the Company	404
Evolving the Governance Model at Filtrox	404
Refocusing Leading to Resurgence	405
Company Profile 15: Pilatus Flugzeugwerke AG—From Aircraft	
Maintenance to Full-Fledged Aircraft Building. International	
Niche Player for Military Training and General Aviation Aircraft	406
The Emerging Aircraft Builder in the Mountains of Central	
Switzerland	406
Starting as Maintenance Arm for the Swiss Air Force	407
Supplying the Swiss Air Force	407
Turning into a Major Supplier of Military Pilot Training Aircraft	408
Expansion into Civil Aviation	409
Developing a Super Versatile Business Jet	410
Subcontracting, Overhauling, and Servicing	410
Building Competencies over Time	411
Focusing on Two Segments	411
Achieving Competitiveness Against Global Players	412
Moving from Corporate Subsidiary to Private Ownership	413
Company Profile 16: DC Swiss SA—Global Niche Player for	
Threaded Connections. Producing Cutting and Threading Tools for	
Micromachining	414
A Global Niche Player from the Jura Region	414
Fallout Between Brothers Spawns a New Business	415
Focusing on Threading Technology	415

Expanding Internationally	416
Segmentation and Segment Choices	416
Focus Within the Focus	416
Building Global Marketing and Sales Footprint	417
Managing Innovations	417
Attracting Talent to Malleray	418
Maintaining Manufacturing in the Jura	418
Frugally Managing Financing and Resources	419
Moving from Family Managed to Professionally Managed Company	419
Company Profile 17: Oetiker Group—Global Leader in Connecting Solutions for Mission-Critical Applications. Creating Peace of Mind Through Billions of Connections Every Day	421
Turning Oil and Gasoline Spots Under Cars into a Global Business	421
Hans Oetiker Started a Small Workshop During WWII	421
An Observation that Kick-Started the Business	422
The Oetiker Business Model	422
The Oetiker Business Focus	422
Targeting Key Segments	423
Driving Innovation	423
Moving Early on Global Expansion	424
Building a Global Manufacturing Footprint	424
Using Acquisitions to Add Assembly Tools or New Segments	425
Preserving the Family Business	425
Company Profile 18: Rüeiger SA—The Temperature and Pressure Measuring Experts. Manufacturer and Solution Provider of Sensors for Temperature and Pressure Indicators	426
Specialist in Measuring Industrial Processes	426
It All Started in a Lausanne Garage	427
Developing a Proprietary Manufacturing Process	427
Sales Development in Phases	427
Expanding into the Asian Markets	428
Offering a Full Range of Measuring Instruments	428
Focusing Manufacturing Footprint	429
Building a Global Sales Footprint	429
Making Technology-Related Acquisitions	430
Innovating into New Fields and Markets	430
Managing Turbulence as a Family-Owned Enterprise	431
Ownership and Governance	431
Company Profile 19: FELCO SA—Producing the Iconic Pruning Shears. “Agricultural Cutting Tools that Can Sustain 10,000 Cuts a Day”	432
Started by a Mechanic in the Jura Region	432

Leaving Home to Look for Opportunities in the Romandie 432

Pruning Loppers Led to Pruning Shears and Cable Cutters 433

Responding to a Winegrower’s Request 433

Responding to an Electrician’s Request 433

The Principles Governing all Felco Products 433

Building International Markets Early 434

Segmenting the Market for Felco Tools 434

Extensive Product Portfolio Aimed at Specific Functions 435

Maintaining Production in Switzerland 435

Living with the High-Cost Base of Switzerland 436

Integrating Backwards into the Value Chain 436

From Selling to Marketing and Branding 436

Creating FELCO MOTION as a Separate Company 437

Entering Partnerships 437

The Felco Talent Management Model 438

Maintaining Family Governance at Felco 438

Self-Financing as Key 438

Company Profile 20: Plaston—From Packaging Solutions to Air
Treatment Systems 439

 Global Leader in Industrial Packaging and Air Treatment
 Systems 439

 Starting Up in a Garage 440

 Finding a Niche in Large Components 440

 Development of Air Treatment Systems Under the Boneco
 Brand 441

 Gaining Hilti as First Key Account in Packaging 442

 Building a Base in the USA 442

 Following Bosch into the Czech Republic 443

 Following Hilti into China 443

 Refocusing the Strategy on Packaging and Air Treatment
 Systems 444

 Innovating Around Products and Processes 444

 Opening Management to Nonfamily Members 445

 Keeping Majority Ownership in the Family 445

Company Profile 21: EAO—Global Experts in Human-Machine
Interfaces (HMI). Push Buttons Withstanding Over Ten Million
Touches over Their Product Life 446

 Visiting the Modern Building Next to Olten Train Station 446

 Two Friends from School Started an Electrical Transformer
 Business 447

 A Customer Suggestion Leads to a New Business 447

 Company Founders Passing Away Led to Business Split 448

 The Second Generation Stepped in 448

 Focusing the Company on HMI Applications 448

Modularizing the HMI Product Platform	449
Creating a Dedicated Value Chain	450
Narrowing Its Segment Focus	450
Integrated Product Development Process	451
Expanding Sales and Marketing Footprint	451
Beating Competition	452
Competing for Talent	452
Being Self-Reliant on Financing	452
Maintaining Family Ownership and Governance	452
Company Profile 22: Selectron Systems AG—From Generalist to Specialist. International Niche Player in Train Control Systems	454
Becoming a Provider of Electronic Train Control and Monitoring Systems	454
Beginning in Automation Components	454
International Competition Began to Take a Toll	455
Moving from Desired Acquisition Target to Corporate Stepchild	455
Searching for a Focus	456
Focusing on the Train Automation Segment	457
Freeing Resources to Finance Restructuring	458
Developing New Generation of Controls	458
Clashing with Parent Company on Business Model	459
Pursuing Independence	459
Employees Buy Out the Company	460
Changing Market Dynamics	460
Slipping Under a Corporate Umbrella Once More	461
Company Profile 23: FISBA—Manufacturer of Optical Components and Systems. From Endoscope Lenses to Camera Lenses for Lunar Orbiter	463
Global Leader in Optical Systems and Components	463
Three Friends Joined to Start a Company	463
Entering Strategic Alliance for Endoscopes with KARL STORZ	464
Expanding into Germany and the USA	465
Winning Accolades for Innovation	465
Joining European Space Agency Projects	466
Cocreating with Lead Customers	466
Investing in Human Capital and Promoting a Cohesive Culture	467
Leveraging Strong Optical Industry Cluster	467
Changing Ownership and Governance	468
Practicing Lean Management	468
Company Profile 24: Maxon—Global Leader in Precision DC Motors. High Precision Drives from Medical Applications to Mars Rovers	470
A World Champion from a Swiss Alpine Village	470
Starting Out with Electric Shavers in Germany	470

Setting Up a Sales Company in Switzerland	471
Supplying Components for Braun	471
Gillette Acquired Braun AG	471
Beginning a New Life as OEM Electric Motor Supplier	472
Spinning Off Elfo	472
Finding a Market for Maxon Motors	473
Breaking into the Japanese Market	473
Winning a Major Customer in Germany	473
Creating a Modular Product Line	474
Evolving the Segmentation Strategy	474
Exploring Space with maxon	475
Internationalizing the maxon Manufacturing Footprint to Germany	475
Expanding Production into Hungary	476
Expansion into Korea	476
Globalizing Sourcing	476
Building a Global Marketing Footprint	477
Competing on a Niche Basis	477
Fighting the Battle for Talent	477
Relying on Professional Management	478
Governance and Ownership	478
Company Profile 25: Sylvac SA: The Measuring Experts. Digital Measuring Instruments and Systems for Industrial Use	479
Sylvac Combining Micromechanic with Microelectronic Skills	479
Two Families Start to Enterprise Together	480
The Entrepreneurial Background of the Meyer Family	480
The Entrepreneurial Background of the Schnyder Family	481
Converting the Sylvac Product Line to Digital	481
A Far-Reaching Merger of Two Family Businesses in 2006	482
Expanding the Sylvac Product Line	483
The Sylvac Manufacturing Footprint	483
Evolving Business and Sales Model	483
Making an Acquisition for Expansion	484
Managing Turbulence	484
Maintaining Competitiveness	485
Ownership and Governance at Sylvac	485
Company Profile 26: Bachem Group—Global Leaders in Peptides. Simplifying the Job of Life Science and Pharmaceutical Researchers	487
Building the Global Leader in Peptide Chemistry in a Small Town Outside Basel	487
Leveraging Apprenticeship into Business Opportunity	487
Unanswered Job Application Lead to a Business Start-Up	488
Scaling the Business Step-by-Step	488

Learning to Focus on Key Industry Segments	489
Expanding Globally Through M&A	490
Creating a New Business Model for the Industry	491
Building Global Sales and Marketing Footprint	492
Building a Global Manufacturing Footprint	492
Investments into Other Companies	493
Sourcing the Necessary Talent	493
IPO Leading to Change in Governance	493
Company Profile 27: LEM—Global Leader in Power Electronics. Design Engineers Worldwide “Take an LEM” for Their Systems Design	496
LEM at the Heart of the World’s Power Electronics	496
An Emerging Entrepreneurial Talent at the Start	496
Starting A Consulting Company on a Kitchen Table	497
Starting Up LEM as an Industrial Enterprise in 1972	497
Expanding LEM Business Activities	498
A Period of Narrowing the Business Focus	499
A Period of Refocusing the Business on Components	499
Finding Global Niches	500
Articulating the Sales Model	500
Enlarging the Manufacturing Footprint	501
Research and Development Function	502
Financing and Raising Capital for LEM	502
Stability in Ownership and Governance	502
Company Profile 28: Acutronic—World Leader in Precision Motion Simulators. Simulating Centrifugal Forces, Flight Profiles, Temperature, or Pressure Conditions	504
Changing from Distributor to Manufacturer	504
Opening of US Subsidiary	505
Founder Bowing Out	505
Focusing on Core Competences	506
Customizing Motion Simulators for the Long-Term	506
Recruiting Talent	507
Surviving the Financial Crisis	507
Passing the Torch to Yet Another Family	507
Prospering Under the Aigrain Era	508
Company Profile 29: LNS Group—Automating the World’s CNC Machine Tools. World Leader in Machine Tool Peripherals	508
Conquering the World from a Small Village in the Jura Bernois	508
The Critical Role of Bar Feeders	509
Starting as a Project Between Friends	509
Convincing Customers of Their “Pain”	509
Market Development and Rollout	510
Expanding Beyond Bar Feeders into Additional Peripherals	510

Expanding into Japan	511
Expanding Throughout the Asian Region	511
Realignment of Manufacturing and Engineering Footprint	512
Business and Sales Model	512
Building a One-Stop-Shop Portfolio of Peripherals	513
Management Evolution and Ownership	513
Passing an Empty Factory Building on Leaving Orvin	514
Company Profile 30: Thermoplan AG—Global Leader in Automatic Coffee Machines for Restaurant Use. Supplying the World’s Leading Coffee Chains	514
From Railway Station Master to Coffee Master	514
Building Institutional Kitchens as a First Business	515
Building a Cold Cream Whipping Machine Business as a Second Business	515
Surfing the Cappuccino Wave as the Third Business	516
Launching an Automatic Coffee Machine as the Fourth Business	516
Partnering with Starbucks and Others	516
Ramping Up Logistics and Production	517
Managing Customer Partnerships	518
Constant Business Model	519
Expanding Development and Engineering Process	519
The Need to Attract Talent	519
Maintaining Family Ownership and Governance	520
Company Profile 31: Komax—World Champion in Wire Processing Machines Helping Customers Manage the Complexity of Wire Processing	521
Learning from a Teenage Part-Time Job	521
A Student Project Leading to a Global Business Idea	521
Modularity of Product Families and Platforms	522
Evolution of Target Market Segments	522
Finding Segment Focus	523
A Roadmap to Discovering New Growth in Wire Processing	523
Entering Additional Steps of the Value Chain	524
Business Model and Strategy	525
Raising the Innovation and R&D Intensity	525
Building a Diversified Global Production Footprint	526
Building a Sales Footprint to Cover Key Markets	526
Talent Sourcing	527
Governance and Ownership Experience	527
Company Profile 32: Mikrop—Niche Player in High Precision Micro-optics. Developing and Producing Miniaturized Optical Systems	529
Becoming a Niche Player for Optical Systems and Components	529

Two Employees Started a Company by Leaving Their Former Employer	529
German Investment Holding Acquired Mikrop	530
Focusing on Process Innovation	530
Developing a Global Sales Footprint	530
Establishing an International Production Footprint	531
Building A Niche in Micro-optics	531
The Challenge of Recruiting and Retaining Talent	532
Practicing A Strong Team Culture	532
Leveraging the Swiss Business Environment	533
Corporate Governance at Mikrop	533
Company Profile 33: Datamars SA—A Pioneer in the Application of RFID. Tagging Laundry and Animals	534
Developing RFID Identification for Pets and Laundries	534
Starting Out in the Laundry Sector	536
Growing in the Companion Animal Market	536
Changing Ownership and Management	537
Surviving Litigation in the USA	537
Concentrating Electronic Production in Thailand	537
Reentering Livestock Identification Sector	538
Restructuring Production Footprint	539
Targeting New Segments	539
Company Profile 34: Medartis AG—From Spin-Off to Global Player in Fixation for CMF and Small Bone Extremities	540
Created from Forced Spin-Off	540
The Technology DNA of Medartis	541
Creating Medartis as Another Start-Up	542
Leveraging the Singular Focus and Experience of the Company Founders	542
Building a Growing Product Portfolio	542
Significant Intellectual Property Protection	543
Running a Multifaceted Business Model	543
Expanding the Global Market Footprint	544
Pushing Technology and Development	544
Colocating Production and Operation	545
Managing and Attracting Talent	545
Providing Financial Resources and IPO	545
Governance at Medartis	546
Company Profile 35: u-blox—Global Leader in Embedded Positioning and Wireless Communications Solutions. Connecting Machines, Vehicles, and People to Exact Positions	547
From Start-Up Idea to World Leader in Just 20 Years	547
Three Students Convinced They Could Do Better	548
Formulating a Business Plan for a New Company	548

Capitalizing on Early Successes	548
Surviving Ups and Downs	549
Creating an Ever-Expanding Product Platform	549
Differentiating Its Business Model	550
Building a “Fabless” Supply Chain	550
Adopting a Unique Development and Innovation Philosophy	551
Managing the Global Sales Effort	552
Selecting Market Segments and Applications	552
Financing the Growing Enterprise with External Capital	553
Management and Company Governance	553
Company Profile 36: Wyon AG—Champion of Small Batteries.	
Developer and Producer of Rechargeable Li-Ion Batteries	554
Undertaking an Apprenticeship as Entrepreneur	555
Recognizing an Emerging Business Opportunity	555
Focusing on Customized Batteries	556
Starting Operations in a Garage on the Alp	556
Employing Plastics Technology	556
Landing an Australian Company as a First Customer	557
Improving Production Processes	558
Adopting Stacking Technology	558
Retooling for Larger Market Segments	558
Leveraging Regional Resources	559
Continuously Improving Technology and Products	560

About the Authors



Jean-Pierre Jeannet served on the faculty of Babson College, USA (1974–2013), where he last held the F.W. Olin Distinguished Professorship, while simultaneously serving on a joint appointment at the IMD Institute, Switzerland (1981–2010), and as Quishi Professor at Zhejiang University School of Management in Hangzhou, China (2013–2015). His teaching and research focused on marketing, strategy, and globalization. He holds the title of Professor Emeritus from both Babson College and the IMD Institute.

Prof. Jeannet is the author and coauthor of a number of books, including *Managing with a Global Mindset*, *Global Marketing Strategies*, *Global Account Management*, *From Coal to Biotech: The Transformation of DSM with Business School Support*, and *Leading a Surgical Revolution: The AO Foundation—Social Entrepreneurs in the Treatment of Bone Trauma*, the latter two published with Springer.



Thierry Volery is Professor of Entrepreneurship and Director of the Management Department at ZHAW School of Management and Law, in Winterthur. He is concurrently Visiting Professor at the University of St. Gallen and at the University of Western Australia. His teaching and research interests include startup process, entrepreneurship behavior, entrepreneurship education, entrepreneurial leadership, and innovation management. He is author of several books and has published in leading journals, including *Entrepreneurship Theory and Practice*, *Journal of Small Business Management*, and *International Small Business Journal*.



Heiko Bergmann is an Adjunct Professor of Entrepreneurship at the University of St. Gallen, Switzerland. His research interests are entrepreneurship, business emergence, and SME management. His research has been published in leading entrepreneurship journals, such as *Research Policy*, *Small Business Economics* and *Entrepreneurship, and Regional Development*. Heiko Bergmann is member of the Editorial Review Board of *Entrepreneurship Theory and Practice*.

Working at the Swiss Research Institute of Small Business and Entrepreneurship (KMU-HSG) at the University of St. Gallen, he has successfully conducted a number of applied research and consulting projects for companies, government agencies, and professional organizations, such as the State Secretariat for Economic Affairs SECO, the State Secretariat for Education, Research, and Innovation SERI, the Swiss Bar Association, and Switzerland Global Enterprise.

He obtained his PhD in economics at the University of Cologne, Germany, and attained his habilitation in business administration with special emphasis on entrepreneurship at the University of St. Gallen.



Cornelia Amstutz Cornelia Amstutz majored in media and communication sciences at the University of Fribourg, Switzerland, with minors in business administration and contemporary history. After her studies, she worked for several years in Berne as a consultant in the field of human resources and market research. Since 2015, Cornelia Amstutz has been employed as a research associate and in the secretariat at the University of Lucerne, first at the former Business Law Institute, and since 2018 in the Internationalization Department of the Faculty of Law. She has coauthored two articles on cooperatives in anthologies. As of 2019, she is also a part-time councilor of the municipality of Engelberg heading the Department of Education, Culture and Sports.

Introducing the Project

For *Masterpieces of Swiss Entrepreneurship*, providing background to the project's origin and the field research process that was employed. Few projects are known to have been undertaken which include such a comprehensive approach, from the bottom up, combining the process of *field-based* case research with in-depth analysis on a large number of Swiss-based SMEs—36 firms in total. Since the founders of these companies and their successors play an intrinsic role in the book, they are described in detail before their actions and practices are meticulously covered in the following chapters.

- **1 Introduction**

Chapter 1 tells the story of the project's origin and how the team members came together to create an extensive, *field-based* research effort. Details about the book's organization are included, as well as some suggestions about how best to absorb both the company profiles in the back of the book and the detailed analyses upfront.

- **2 Founders, Prime Movers, and Shakers**

This chapter introduces the reader is introduced to the principal actors of these stories, namely the founders and, in some instances, prime movers who, at a later time, gave the companies their final direction. The founders and companies are listed by date of company creation, a sequence that is maintained throughout the book.



Undertaking the Project

Switzerland's concentration of small and medium-sized enterprises (SMEs)—many of which have achieved niche positions in the global export marketplace—is both remarkable and inspiring. So much so that it seemed high time that they became the subject of a book. *Masterpieces of Swiss Entrepreneurship* spotlights just these SMEs—a critical element of the Swiss economy—while emphasizing, in particular, how these companies arrived at their excellent positions. However, this text is not a cookbook offering simple recipes for success. Instead, the authors feature management practices relevant to practitioners, in addition to offering inputs for academics, policymakers, educators, and the public at large. The book's title was chosen, in part, because the achievements of these companies may also inspire future generations of entrepreneurs. The hope is to impact the managerial practice of existing firms, as well as of companies that are yet to be created.

In Switzerland, SMEs mastering success in exporting, based upon strong global market performance, represent an important part of the economy; their continued success is critical for Swiss society. As a result, these companies have, in the past, attracted considerable attention from academics and practitioners alike. Many of the previous studies, however, have generally suffered from some important weaknesses:

- Attention was often spent on the *present market position* of selected Swiss SMEs, and their strategies, as they are pursued today.
- Research did not offer insights along the *longitudinal development of a firm* and the reasons why certain decisions were taken, nor how the firm got into the position to take advantage of global market opportunities.
- Scant attention was focused on the *environmental context* of a firm, and how SMEs interact with the local *ecosystem*, ranging from economic development, public infrastructures, to educational institutions.

The authors recognized the need for an in-depth and holistic understanding of these companies' sustained success, as well as how this performance was achieved. Discovering these underlying factors, whether external or firm-internal, was viewed as necessary for any multiplication of achievement and for the creation of new firms that could advance along a similar growth path. Such insights cannot be obtained solely by describing present situations, showcasing results and the strategies of winning companies. A much deeper knowledge and understanding is required to fully appreciate this reality, in addition to increasing the chance of multiplying success. It cannot be obtained by simply taking a still shot of the current status of successful SMEs.

Genesis of This Project

The research project that led to this book was characterized by a long incubation period, dating back almost 10 years. For years, Professor Jeannet spent several weeks each year in Switzerland's Emmental region as part of his summer holiday, enjoying the serenity of an old farmhouse and venturing out into this picturesque region. As a business school professor, it was second nature to notice the industrial enterprises dotting the landscape. On closer inspection, it turned out that there were a number of medium-sized firms that had managed to develop export businesses with niche products sold into markets worldwide.

Having stepped down from faculty appointments at IMD Institute and Babson College, Jeannet accepted a chair in 2013 at Zhejiang University School of Management in Hangzhou, China. Given the strong entrepreneurial culture of the Hangzhou region, when asked to give an opening lecture to the faculty on a piece of recent research, Jeannet documented and presented the stories of these firms in the Emmental. The talk entitled "Hidden Champions of the Emmental" was presented to a Chinese audience with the thought that the trajectories of these companies, although a world away, would be of interest.

Chasing a "Big Idea"

The following year, in one of the regular meetings with the leadership of Renaissance Capital,¹ managing partner Christian Waldvogel was curious about Jeannet's recent research agenda. While sharing the Emmental presentation Jeannet had made in China, Waldvogel embraced the idea immediately, suggesting that this subject be studied across all of Switzerland. If such a project was extended to cover the experience of Swiss exporting SMEs that had achieved major success in global markets, their examples might serve as an inspiration to countless other companies,

¹Founded in 1997, Renaissance Capital Foundation (previously Vinci Capital) is located on the campus of École polytechnique fédérale de Lausanne (EPFL).

both existing and emerging. When Jeannet pointed out that such a project was beyond the capacity of a single retired faculty member, Waldvogel offered help with finding additional resources. Intrigued by, and now hooked on this “Big Idea,” Jeannet agreed to pursue the research project on a Swiss scale. From that moment on, it would take the undertaking another 6 years to be concluded.

In order to accomplish the project objectives, a different and yet, for this area, untried *research paradigm* was needed.² The adoption of a *field-based* research approach focused on *longitudinal* documentation of selective firms, followed by clinical case analysis, was deemed to yield superior results, uncovering insights not possible with the typical statistical data-driven approaches favored by many researchers.

Recruiting a Team of Like-Minded Researchers³

Recognizing that the scope of such a project was beyond the effort of a single academic, Jeannet put feelers out to several Swiss universities where he had contacts with faculty members and researchers working on issues related to entrepreneurship. Professor Thierry Volery at the University of St. Gallen was eager to join the effort, enthusiastically supporting the project from the outset and willing to look for resources. Through him, Professor Heiko Bergmann was also recruited. At the University of Lucerne, Cornelia Amstutz provided both organized administrative and research support. Contacts with other university research teams did not come to fruition. This small group became the core team, collaborating over the years, putting the project together, piece by piece.

The team was enhanced ad hoc by a number of talented students and independent researchers who actively contributed over the years as part of their academic programs. After first contacting a number of business and government organizations in vain, financial support was eventually obtained in 2016 and 2017 from several Swiss foundations, helping to cover the necessary expenses in order to pull the project off and see it through to publication. After an extended period of planning, the first company interview was conducted in April 2017, the last one in late 2019.

Selecting a Research Design Fit to Purpose

The aim was to take a different approach and target different conclusions. Selecting firms that were already successful would contribute novel insights only if describing success alone was avoided; instead, the spotlight needed to be turned on the managerial practices that made these companies successful. Preferably, firms to be included should have been in existence over longer periods of time. This required

²Yin, R.K. (2009) Case study research: design and methods (4th edn.). Sage, Thousand Oaks, CA.

³For more details of all contributions, see the Acknowledgment section of this book.

unearthing the journeys that these companies have been through, and with a broader perspective than merely their end destinations, which many existing publications have already covered.

Looking at overall business success requires the inclusion of a full range of entrepreneurial and managerial activities beyond exporting and innovating exclusively. Uncovering the entrepreneurial journeys of these firms meant expanding the scope, from statistics to questioning companies directly about the key steps taken, in search of the underlying rationale. Consequently, this unique research approach inspired an intensive and historically oriented review of the firms. The longitudinal and field-based case approach was reinforced by in-depth background research sourced from secondary materials and followed up by face-to-face interviews.

Identifying Firms to Research

With the review of academic literature and similar research publications began an intensive debate about where to draw the line. The aim was for a broad industry spectrum, from technology B2B companies to B2C firms. Member companies of the watch industry were specifically excluded due to the fact that they face a very different competitive environment.⁴ Selecting exporters meant that only manufacturers were included, at the exclusion of service companies. The “All of Switzerland” scope presented the challenge of finding companies from Lac Léman (Lake Geneva) to the Bodensee (Lake Constance), as well as from Basel to Chiasso in the Canton of Ticino.

In terms of company age, firms that demonstrated at least 20 years of continued existence were preferable and, even better, those that have been around much longer. By comparing younger companies with older firms, changes in practice over time can be detected. The youngest firm was founded in 1999 (**Wyon**) and the oldest in 1833 (**Sefar**). As far as the size of companies was concerned, the guideline was a typically used band of CHF 25 million to CHF 250 million in sales, combined with an export ratio of at least 50%. Not wanting to lose the insights that might be gained from companies which started out small, but after some time grew beyond the CHF 250 million limit, the ceiling was first lifted to CHF 500 million and, in the end, included one company that had reached CHF 1 billion in sales. The authors are aware that some of the researched companies have outgrown the official definition of a small and medium-sized enterprise. Still, throughout this book, the term SME is used because all of the companies in the sample, and even the bigger ones, share important SME characteristics and for much of their existence were operating within the typical SME sales band.

⁴Dr. Ernst Thomke, with his broad experience in the watch industry, supported our decision. Interview was conducted on August 17, 2017 in Grenchen.

Establishing a Long List

Much of the early research phase was spent assembling a list of about 100 firms that could fit the research purpose. There was no single, all-inclusive list, of such companies readily available. Over several months, every available publication was scoured in order to build a long list, recording each company with date of foundation, industry, ownership, location, current sales, and number of employees. Business contacts and other academics supplied additional names for consideration. In parallel, companies were identified that might make good targets for further investigation, with special attention paid to spread in terms of industry, geography, and company age.

When making first contact, it became clear that the research team should concentrate on firms where a personal contact existed, or where an introduction could be obtained. Cold calling did not work. The target list was shared with individuals at the Renaissance Foundation and SVC Foundation.⁵ Doors began to open when the authors contacted target firms based upon these recommendations.

Selecting a Convenience Sample

In the end, a convenience sample of 36 companies was assembled. That group agreed to in-depth interviews, mostly on company premises. Because it was preferable to interview one or several company leaders, organizing and scheduling the interviews took considerable time. In total, the interviews took place over the space of two and a half years.

Due to the fact that there was a reliance on companies whose management teams were willing to be interviewed, and ready to divulge a considerable number of internal events and data, the sample was likely skewed toward more successful companies. The intention of working with long-running companies has not posed any obstacles. The inclusion of failed firms as a control group was not found to be workable since those firms, or their previous leaders, were difficult, if not impossible, to reach.⁶

Creating a Company Specific Database

Each target company was documented in detail, based upon publicly available data. Using internet resources and databases, material going back to the founding date of the companies was collected and checked. Additional information was obtained from the companies' own internet sites. The material was then cataloged by

⁵SVC Entrepreneurship Foundation, Thun.

⁶The research team was aware of the writing by Rosenzweig, R. (2008) *The halo effect: how managers let themselves be deceived*. Simon & Schuster UK, London.

company, identified by the provenance of information and dated, all along a standardized schema.

That database included a large number of documents, some PDF documents of newspaper extracts, journals, and even patent filings, as well as any information released by the companies. The data format was linked interactively to the original content, allowing the team to access all data when further researching the company.

In a final step, every piece of company information was organized along a timeline affording a clear overview of all major events, developments, performance, and reports over the entire life of the firm. For companies founded more recently, internet-based research was quite complete. This was not the case for all of the companies with beginnings in the pre-internet era, yielding more limited data points.

The timeline was a listing of abbreviated actions, summarizing the key content of each data point. In printed format, this timeline document was typically 10–20 pages for each company and proved to be an excellent base for preparing for the interviews.

Conducting and Documenting Interviews

Prior to starting the interview phase, a long list of topics was established for the purpose of clarification. These subjects covered the full range of company actions from early start-up to a full set of company functions and processes. It was recognized that a data set covering every issue from every firm interviewed would not be obtained.

The interviews concentrated on finding out the rationale behind actions documented in the timeline. Any information, or answers, readily available in the public domain were avoided in an effort not to waste executive time. Some interviewers taped the conversations for later transcription, while others took extensive notes. Each interview followed a semi-structured format, combining a series of pre-determined and open questions. There was enough free flow to allow for conversations to pursue previously undocumented events. Initially, the interview language was English but later interviews were also conducted in German.

A detailed interview protocol was written following each interview and ran from 10 to 20 pages. They were filed in English since it was important to have critical technical and industry terminology in English for the company profiles and the ensuing book text. A considerable amount of time was invested in transcribing both notes and texts. These protocols were kept confidential, shared neither with the companies nor anyone beyond the research team.

Compiling Company Profiles

The next substantial phase was writing a profile of each company, each one similar in length and detail, as well as in terms of organization and style. The role models for these profiles were Harvard Business School and IMD Institute teaching cases, two institutions with a long tradition of case writing. While the language and style format

were adopted, including keeping the text in the past tense, there are still considerable differences between the company profiles in this book and the more typical teaching cases.

Company profiles in *Masterpieces of Swiss Entrepreneurship* have been written as stories to keep the reader engaged. They recount key events at the companies, the main players, include background about the related industry and, above all, provide access to the key practices that eventually led to the firms' successful niche strategies. Any conceptualization, analysis, or evaluative comments were excluded from these profiles, reserving that content for the analysis section of the book (Chaps. 2–23).

Each profile was edited a number of times so that the reader can enjoy the stories, which are often unknown to the public. Wherever possible, interviewee quotes are included in the profiles and a number of them are also used as illustrations for the analysis in the chapters.

Requesting Fact Checks

Although the database, timelines, and interview protocols were not shared with the firms, the profiles were shared in order to undergo a fact check. The research team wanted to be sure that the data, facts, names, and key events were accurate.

The profiles were written by the research team in their own language and terminology. Companies were not required to sign a formal release regarding the content as they would with regular teaching case studies. Each company was also invited to supply a visual of its product line for inclusion in the book. Most companies participated in both the fact-checking and the supplying of visuals.

Performing Pattern Analysis

The analysis of the accumulated company profiles was approached without any preconceived notions: there were no hypotheses to test and no theories to be confirmed, only an open mind to results. The analysis was inductive, following the subjective interpretation of text data through a systematic classification process of identifying themes or patterns. At the center of attention were company practices and not cross-company comparisons. The practice patterns found were then grouped around managerial themes (Chaps. 3–22) with a strong focus on business practices, resulting in more than 100 individual practice elements.

Following the themes of business practices, the goal was to achieve a realistic description of those practices that have governed these companies over the long haul, while at the same time offering insights to current SME managers. To make the analysis tangible and useful to the management community, it was necessary to illustrate the practices in considerable detail. For each broad practice area, the 36 company profiles were reviewed for detailed examples, then grouped and categorized.

The resulting level of specificity was driven beyond the obvious, such as *focusing* or *innovation*. The goal was to come much closer to answering questions such as: “How does a company find its focus?”; “How does a company implement a focus?”; “How can an SME drive innovation?”; and, “What are the sources for new ideas?”—all queries that were gleaned from the stories of the company profiles.

No singular pattern emerged. For each of the broad practice areas, different approaches to implementation were identified. The sample companies adopted at least one practice per given practice area, while some adopted several. This applied to the areas of focus, marketing, product, and production, as well as innovation. Differences were more notable for the areas of governance, management, and financing.

Analyzing Management Practices

In order to convey the observed patterns in significant detail, it became necessary not to offer just the conclusions by themselves without supporting evidence. Therefore, every piece of evidence was coupled with excerpts from the relevant company profile, placed right in the text. This way, the reader can avoid constantly turning to the company profiles for further details; the analytic text became a freestanding part of the book.

Visually, company names from the profiles appear in bold; the profile parts cited are also set apart so that a reader can quickly scan them and spot practices associated with certain firms. The frequent references are designed to indicate from which company the particular conclusions, or described practices, originated.

Adding to the understanding of the large number of practice elements, overview charts appear in book sections or chapters, as well as a list of the companies and a related scoring, illustrating the extent to which given practices were adopted by the companies. This scoring, expressed in symbols, reflects a judgment on the part of the authors.

Compiling Company Profiles

Citing the relevant company excerpts in the analytic text should not be construed as undue duplication between the book’s analysis and the company profiles included in the back. All profile excerpts in the analysis were referenced in the form of *adapted from*, indicating that the cited text portions were edited, sometimes shortened, and rewritten to emphasize the particular practice on which the authors wished to focus.

For a full understanding of the entire company history and journey, only the entire profile can give the reader a complete overview. At the same time, readers who wish to read only the profiles might find it difficult to get an insight applicable beyond a specific context, such as a firm or an industry. Both the company profiles and the analytic text are independent elements of the book and each plays its own role.

Why then include the complete profiles in the book? In addition to allowing a reader to read a company profile in its entirety without analytic comments, the purpose was also to provide transparency regarding the research process. The analysis, unless so mentioned, and that only in rare cases, was based entirely on the company profiles included in the book. Any reader or researcher, staying within the same boundaries offered here, is invited to perform additional analysis or extract findings beyond those articulated by the research team.

Clustering Growth Trajectories

While the bulk of the analysis is focused on individual practices, when grouping all firms, it was clear that there was a need to reflect comparatively on the experience across all documented companies. Thus, a chart was created to depict all the firms in terms of length of operation (age in years) and growth (sales), resulting in six different clusters subjected to further analysis (Chap. 23).

After reflecting on the different growth patterns exhibited by these clusters, they were named for specific Olympic track and field running disciplines: *Long Distance*, *Middle Distance*, *Sprinters*, and *Steeplechasers*. The principal forces that accounted for growth over time, and the dynamics that accounted for longevity, have also been included. These forces and dynamics were composed of bundles of the practices described earlier. While the longevity of all firms was closely related to the adoption of the practice patterns, also described earlier, the speed of growth in sales was more closely related to the governance, management, and financing choices made. Again, the allocation of the sample companies to a given cluster represented a judgment call on the part of the authors.

Reflecting on Impact of Swiss Entrepreneurship Ecosystem

While working on this project, a number of visitors, and authors, from outside of Switzerland frequently inquired as to why Switzerland enjoyed such a density of export-oriented and prosperous SMEs. To answer these questions, both historic and recent writings of international observers with contact to Switzerland were reviewed. The authors decided to offer their views on whether such SMEs were unique to Switzerland, or whether such companies, relying on the practices described in this book, might also flourish elsewhere.

Adding to these reflections, the authors have collected their own thoughts stemming from the conclusion of this research effort—for the business community, economic policy, education, and public policy. These comments are offered as a list, not in full prose, and reflect the combined learning of the authors from undertaking this project.

How to Read This Book

Recognizing that few readers will go through the book, page by page and front to back, the material is presented in such a way that it should be rather convenient to find the parts of greatest interest to a particular reader. The analysis part of the book can be entered at any point of interest, with the relevant company information provided then and there. Placing the company profiles in a bloc, at the end of the book, should enable readers with a particular affinity to a given company to readily locate that profile and read it uninterrupted, in its entirety. Then again, other readers may well find that the company profiles are of interest on their own and worth reading, because each represents a unique, fascinating and complete journey, often unknown to professionals, practitioners, and the public at large.

Open Access This chapter is licensed under the terms of the Creative Commons Attribution 4.0 International License (<http://creativecommons.org/licenses/by/4.0/>), which permits use, sharing, adaptation, distribution and reproduction in any medium or format, as long as you give appropriate credit to the original author(s) and the source, provide a link to the Creative Commons license and indicate if changes were made.

The images or other third party material in this chapter are included in the chapter's Creative Commons license, unless indicated otherwise in a credit line to the material. If material is not included in the chapter's Creative Commons license and your intended use is not permitted by statutory regulation or exceeds the permitted use, you will need to obtain permission directly from the copyright holder.





Who Were Those Guys?

While reflecting on the histories and trajectories of the 36 researched companies, it became clear early on that the personalities involved in the creation of these firms played a special role in the firms' histories and eventual successes. Thus, not only were the founders' own backgrounds tracked but so were the firms' formation, as well as the working relationship these individuals had prior to the companies' creation.

Given that the individual stories not only differed for each company, in addition to the era in which they were founded, the founders were grouped into several different periods. Because the oldest firms were more than 125-years old, the experience of those founders, and their origins, could not be compared to the companies formed in later periods.

The selected time periods:

- The Early Founders: Pre-World War I (WWI)—six companies
- Interwar Depression Period: Between World War I and World War II (WWII)—six companies
- The Period of World War II—five companies
- Post-World War II “Baby Boomer” Period 1945–1980—15 companies
- The Newcomers Recent Period Late twentieth Century—four companies

At the time of this writing, all of these firms were in continuous operation and all but the most recent have changed hands in terms of management and ownership.

The changing histories of these companies also meant that other movers and shakers were involved; attention needs to be paid to the prime movers who were the most important in terms of moving the companies toward their eventual trajectory. Consequently, some additional space is devoted to prime movers, in order to differentiate them from founders (Tables 2.1 and 2.2).

Table 2.1 List of founders

Start company name	Activity	Founder
1833 Sefar	Weaving	Pierre Dufour
1844 Burckhardt Compression	Compressors	Franz Burckhardt
1851 Geistlich Pharma	Bioscience	Heinrich Geistlich
1879 Sécheron	Transformers	de Meron/Thury
1885 Cendres +Métaux (C+M)	Parts manufacturing	Louis Aufranc
1886 Lantal Textiles	Textiles/Weaving	Friedrich Baumann and Albert Brand
1908 Max Felchlin	Chocolate	Max Felchlin
1923 Plumettaz	Cable laying machinery	Emile Plumettaz
1924 Caran d'Ache	Writing Instruments	Arnold Schweitzer
1925 Kuhn Rikon	Cooking pans	Heinrich Kuhn
1930 Ricola	Herbal candy	Emil Richterich
1931 Jura	Espresso machines	Leo Henzirohs
1934 Fraisa	Cutting tools	Johann Stüdeli
1938 Filtrox	Depth filtration	Hans Schmid
1939 Pilatus Aircraft	Aircraft	Emil Bührle
1940 DC Swiss	Threading tools	Daniel Charpillot
1942 Oetiker Group	Connectors	Hans Oetiker
1942 Rüeger	Measurement	Ernst Rüeger
1945 FELCO	Pruning shears	Felix Flisch
1947 EAO	Control buttons	Kurt Loosli and René Thalmann
1956 Selectron	Train controls	Paul Stegmann
1956 Plaston	Packaging containers	Hans Frei
1957 FISBA	Optical components	Waldemar Striezel, Hennoch Altherer and Christian Fischbacher
1961 maxon	Electric motors	Braun Family
1969 Sylvac	Measuring systems	Hans Meyer and Urs Schnyder
1971 Bachem	Peptides	Peter Grogg
1972 LEM	Electric measurement	Jean-Pierre Etter
1973 Acutronic	Motion simulators	Leo Marxer
1973 LNS	Bar feeders	André Léchet, Walter Neukomm and Maurice Scemama
1974 Thermoplan	Coffee machines	Domenic Steiner
1975 Komax	Cabling machinery	Max Koch
1981 Mikrop	Optical components	Gerhardt Machleidt and Erhart Müller
1988 Datamars	RFID solutions	Audemars, Datalogic

(continued)

Table 2.1 (continued)

Start company name	Activity	Founder
1997 Medartis	Medical implants	Thomas Straumann and Willy Miesch
1997 u-blox	Positioning systems	Daniel Ammann, Andreas Thiel and Jean-Pierre Wyss
1999 Wyon	Batteries	Paul Wyser

Source: Compiled by Authors

Table 2.2 Founders

Profile Number	Company Name	Foundation	Founder Background							
			Relevant industry experience	Training in technical apprenticeship or education	Attended technical university	Background in business & finance	Founder Playing Main Role	Prime Mover Role	Woman playing Role	
1	SEFAR	1833	●	○	○	○	○	○	○	
2	Burckhardt Compression	1844	●	●	○	○	○	○	○	
3	Geistlich Pharma	1851	○	○	○	○	○	○	○	
4	Secheron	1879	○	○	○	○	○	○	○	
5	Cendres & Métaux	1885	○	○	○	○	○	○	○	
6	Lantal Textiles	1886	○	○	○	○	○	○	○	
7	Max Felchlin	1908	○	○	○	○	○	○	○	
8	Caran d'Ache	1915	○	○	○	○	○	○	○	
9	Plumetzaz	1923	○	○	○	○	○	○	○	
10	Kuhn Rikon	1926	○	○	○	○	○	○	○	
11	Ricola	1930	○	○	○	○	○	○	○	
12	Jura	1931	○	○	○	○	○	○	○	
13	Fraisa	1934	○	○	○	○	○	○	○	
14	Filtrox	1938	○	○	○	○	○	○	○	
15	Pilatuz	1939	○	○	○	○	○	○	○	
16	DC Swiss	1940	○	○	○	○	○	○	○	
17	Rueger	1942	○	○	○	○	○	○	○	
18	Oetiker	1942	○	○	○	○	○	○	○	
19	Felco	1945	○	○	○	○	○	○	○	
20	EAO	1947	○	○	○	○	○	○	○	
21	Selectron	1956	○	○	○	○	○	○	○	
22	Plaston	1956	○	○	○	○	○	○	○	
23	FISBA	1957	○	○	○	○	○	○	○	
24	maxon	1961	○	○	○	○	○	○	○	
25	Sylvac	1969	○	○	○	○	○	○	○	
26	Bachem	1971	○	○	○	○	○	○	○	
27	LEM	1972	○	○	○	○	○	○	○	
28	LNS	1973	○	○	○	○	○	○	○	
29	Acutronic	1973	○	○	○	○	○	○	○	
30	Thermoplan	1974	○	○	○	○	○	○	○	
31	Komax	1975	○	○	○	○	○	○	○	
32	Mikrop	1981	○	○	○	○	○	○	○	
33	Datamars	1988	○	○	○	○	○	○	○	
34	Medartis	1997	○	○	○	○	○	○	○	
35	U-Blox	1997	○	○	○	○	○	○	○	
36	Wyon	1999	○	○	○	○	○	○	○	

Source: Table Compiled by Authors

Founders from the Early Period

The histories of firms, which are still operating after more than 125 years show that founders have taken one of two approaches: the first by operating as single owners who capitalized on their own technical skills, and the second by having teamed up with technical talent.

A group of the early founders were single entrepreneurs who started small businesses, or workshops, based on their skills and then grew the enterprise over time, usually turning the companies over to a second generation to promote growth.

- **Pierre Dufour**, an expert in silk weaving, separated from the Zurich family Bodmer who had a long history in silk trading, to create his own silk gauze weaving company in Thal, in 1833, which was to become **Sefar**.
- In Basel, **Franz Burckhardt** started a mechanical workshop, in 1844. Today it is **Burckhardt Compression**.
- **Heinrich Geistlich** created his company **Geistlich** in Zurich, in 1851, collecting bones from slaughterhouses to turn them into glue.
- In 1885, pharmacist **Louis Aufranc** started what became **Cendres + Métaux (C +M)** in the back of his Biel/Bienne pharmacy, melting gold and silver left over by watchmakers, remains there were meant to be reused.

The technical backgrounds of these early founders were based on accumulated experience, not from formal technical training. They were problem solvers and developed their products through trial and error but also had a clear understanding that their innovations were needed.

Given the scarcity of capital at that time, a second pattern emerged from studying these early companies: entrepreneurs with financial resources teaming up with a gifted technical person who brought their know-how to the venture.

- Along these lines, Geneva businessman **Alfred de Meron** worked with **René Thury**, a gifted engineer, in 1879, to start what today is known as **Sécheron**.
- In Langenthal, **Friedrich Baumann**, having a background in textile trading, found his partner Albert Brand to start in 1886 what is now **Lantal Textiles**.

At the time, it was the nature of the situation that the early founders were able to bring the companies only so far and that major growth in all of these firms occurred in subsequent periods, usually more than a generation removed. Often, these companies were transferred to later owner generations, becoming family companies. At the time of their creation, however, there was no such plan and no indication that the early founders worked off a blueprint or even a business plan as is known today. Some of the early founders would probably be surprised at how large their ventures turned out to be.

Founders from the Interwar Period (WWI to WWII)

Looking at the companies created during this interwar period, largely impacted by the experience of a global recession that also touched Switzerland, the founders confronted a very different economic situation. Not to be deterred, these founders started business and saw opportunities where others hesitated, and in some cases were told that they were literally nuts to undertake the effort. On one hand, this was an uncertain period when people valued security above all else and did not engage in risky ventures. On the other hand, the hard economic time drove a number of companies into bankruptcy, which became acquisition targets for those willing to venture out. These founders did not continue with their previous businesses but used old assets, such as workshops, as the basis from which to move forward with innovations into various sectors.

Above all, the founders at that time were all skilled craftsmen who had often gone through the Swiss apprentice system, the dual educational system where young people left school at around 15 or 16 years of age to learn a trade through a 3- or 4-year apprenticeship. They all came from families of modest financial means.

- In 1923, at the age of 38, **Emile Plumettaz** founded **Plumettaz**, leaving a secure job at Nestlé to start his mechanical workshop.
- **Heinrich Kuhn**, a mechanical engineer, returning from France, acquired the workshop that was to become **Kuhn-Rikon** in 1925.
- A master baker and confectioner, **Emil Richterich** started his bakery shop in 1930 at the age of 23 which became **Ricola**.
- Electrician **Leo Henzirohs**, at age 29, started his workshop in order to build electrical appliances in 1931 and grew it to **Jura Elektroapparate**.
- Metal tool mechanic **Johann Stüdeli**, at the age of 46, acquired part of a bankrupt operation in 1934 and built it into **Fraisa**.

Different were the backgrounds of two founders who had their roots in commerce and finance.

- **Max Felchlin**, educated in commerce, began a honey trading business in 1908 at just 25 years old. His eventual food processing business, which was also started post-WWI, grew into a flourishing business still bearing the name **Max Felchlin**.
- In 1924, a group of local Geneva investors, under the leadership of **Arnold Schweitzer**, took over a distressed pencil company that had entered bankruptcy to start a new firm that is now **Caran d'Ache**.

Founders Creating Businesses During WWII

The period of WWII was a time of scarcity and deprivation in Switzerland, despite the fact that the country was not directly involved in the war. International trade was disrupted and both imports into and exports out of Switzerland were substantially

curtailed. And yet, during this time there were still some entrepreneurs willing to start businesses of a lasting nature.

- Anticipating the disruption of the coming political crisis in Europe, **Hans Schmid**, working as a Swiss sales representative for a German company, created **Filtrox** in 1938 by acquiring an old textile plant in Eastern Switzerland.
- In 1939, following the suggestion of the Swiss government, industrialist **Emil Bührle** created **Pilatus** to service Swiss army aircraft.
- In the Jura, **Daniel Charpillot**, a mechanic and toolmaker, left his family business in 1940 to start on his own enterprise, creating what became **DC Swiss**.
- In the Zurich area, **Hans Oetiker** left his position as a toolmaker with Brown Boveri (today he would be called a polymechnic) in 1942, at the age of 24, to start out on his own and create what would become **Oetiker Group**.
- In 1942, **Ernst Rüeger** moved from Basel to Lausanne to be further away from the area where he met Georges Bloch, an engineer, and created the **Rüeger** company, based on Bloch's invention.

Of these founders, only Oetiker came from a family of modest financial means. The others, through either past business experience or family backgrounds, already had access to capital in order to start their businesses.

Founders from the Post-WWII “Baby Boomer” Generation

The post-WWII period in Switzerland was characterized by rapid economic growth. This period saw the emergence of many of the researched companies. Most of them grew rapidly and exceeded a size normally considered typical for an SME.

- **Felix Flisch**, a mechanic, founded his company at the age of 31, in 1945, making pruning shears in the Neuchatel Jura; the company later became known as **Felco**.
- In 1947, **Kurt Loosli** and **René Thalmann**, two 26-year-old polymechnic engineers, founded **EAO** in Olten, producing transformers for trains and electrical cabinets.
- **Hans Frei** left his employer in 1956, at the age of 55, due to health reasons and started **Plaston**, near St. Gallen.
- In Lyss, **Paul Stegmann**, a technically oriented businessman, started **Selectron** in 1956, producing electronic controls.
- **Christian Fischbacher**, a business owner from St. Gallen with a background in the textile industry, **Hennoch (Heni) Altherr** and **Waldemar Striezel**, both optical engineers, opened **FISBA** to make optical components in 1957.
- In Sachseln, the **Braun family**, successful industrialists originating from Germany, started a component business for electric shavers in 1961 that became **maxon**.

- In 1969, the two fine mechanics **Hans Meyer** and **Urs Schnyder** combined their operations to form **Sylvac**, in both Renens and the Jura Bernois, making industrial measurement devices.
- A 29-year-old chemistry lab technician **Peter Grogg** started **Bachem**, near Basel, by selling peptides to the pharmaceutical industry in 1971.
- **Jean-Pierre Etter**, an electrical engineer with an interest in physics, created **LEM** in Geneva in 1972. He was 37 years of age and had previously worked for Brown Boveri, as well as having started an engineering business.
- **Leo Marxer**, an engineer, founded **Acutronic** in 1973, entering the simulation field because he could not get his US supplier to adapt the equipment to local requirements.
- **LNS** was created in 1973 by **André Lécho**t, an engineer who ran his own mechanical workshop in the Jura Bernois, together with two business associates, **Walter Neukomm** and **Maurice Scemama**, who helped scale the company, which produced innovative bar feeders for automatic machining centers.
- **Thermoplan** was founded in 1974 by **Domenic Steiner** who had left his position as stationmaster for the Swiss Railways to become an entrepreneur without a clear business plan. The idea to build automatic espresso coffee machines came later.
- **Max Koch** graduated from the Swiss Federal Institute of Zurich (ETH Zurich) to create **Komax** in 1975, in order to follow up on an earlier idea to make the joining of electric cables more efficient.
- **Gerhardt Machleidt** and **Erhart Müller**, both optical engineers, left their employer in 1981 to create **Mikrop**, offering improved optical equipment.

The majority of these founders had technical backgrounds relevant to the industry sectors they entered. Among those starting up immediately after WWII, completing an apprenticeship was the usual step to take in order to acquire the necessary background in a technical formation. In later years, engineering backgrounds became largely based on the education at today’s University of Applied Sciences (Technikum). Some founders, like Max Koch who graduated from ETH, moved directly from university to create their own companies. In general, these founders were still in their 20s and their start-ups represented their first business ventures.

There are also family groups—including both the Braun and the Meyer and Schnyder families—who built businesses. Some of these entities were started by later-stage founders who had had previous business careers in their industries or who had owned related companies. The failure of a supplier or an employer to innovate also gave rise to the founding of companies. As witnessed in previous periods, some companies were ventures between inventors and experienced industrialists, which combined capital and business acumen with innovative product ideas.

Possibly the only outlier in this group was Domenic Steiner who left his secure position with the Swiss Federal Railways (SBB) to “become an entrepreneur” without any clear notion as to what to build. His previous experience as station master did not really prepare him for his entrepreneurial endeavors, although he turned out to be most successful at it.

Founders from the More Recent Era

The four companies from the most recent era are, by their very nature, the youngest crop of companies included in this research. Their stories, nevertheless, are of great interest because they indicate the most recent company trends in starting up new ventures. At the same time, they show the very diverse nature of the origins of companies and how ideas led to their creation.

- **Datamars** was created in 1988 as a joint venture between two existing companies, which merged their expertise to form the new firm. **Audemars** had the collective micromechanical and electronic knowledge of a watch component manufacturer, while **Datalogic** specialized in bar codes. The new company specialized in radio-frequency identification (RFID) solutions.
- **Thomas Straumann** and **Willy Miesch** created **Medartis** in 1997. It was Straumann's second venture and as a spin-off from Straumann Dental—Straumann's first venture that had already grown beyond SME size—focused on medical implants.
- **u-blox** was created as a start-up in 1997 by three ETH Zurich engineering students, **Daniel Ammann**, **Andreas Thiel**, and **Jean-Pierre Wyss**, who left their Ph.D. program to start the company, whose focus was on providing solutions to connect satellite-based positioning solutions.
- The youngest company in the sample, **Wyon**, was started in 1999 by **Paul Wyser** who became disenchanted with his previous employer, the Swatch Group. He convinced his two sons Maurus and Philipp to join him in starting up a company to produce special rechargeable Li-ion batteries.

The pattern of previous founders having utilized deep technical backgrounds and experience for their new ventures repeated itself. Whereas the creation of **u-blox** reflected the most recent trend to start-out from university, the other examples show that entrepreneurial ventures also can be created in later stages of life, whether as a second venture or by leaving an employer who was not willing to pursue new ideas.

What happens when two polymechnic apprentices combine efforts to create a company is demonstrated by **Medartis**, the second youngest company in the research. Both Thomas Straumann and Willy Miesch met during their apprenticeship as polymechnics at the Straumann Institute.¹ They later pooled their experience to manufacture demanding medical implants and create Medartis. By that time, both of them had long since moved beyond the apprenticeship stage and accumulated extensive operational management experience in managing medical implant companies.

¹The term polymechnic is one used more recently in Switzerland, superseding older terminology, such as precision mechanic or fine mechanic.

Differentiating Between Prime Movers and Founders

A major impulse for the growth and development of a company need not come from the founders alone. Although the original founders played key roles in creating the companies, in many situations, and particularly when considering a longer time frame, other personalities stepped in and either redirected a company's strategic trajectory or resurrected it and rescued it from failure.

One of the more telling examples of founder versus prime mover is offered by **Selectron**. Founded in 1956 by a technically oriented entrepreneur, the company soon reached sales of CHF 30 million by producing electronic devices to drive machine tools. With its products losing out against larger international firms, the company went through a period of declining sales, accumulating losses. Passing through several hands, the company was acquired by a large international firm, which in fact, had no use for it. Tasked to liquidate the company "without creating any waves", Emmanuel Hannart discovered that the company had some neglected and unappreciated technical strength. Focusing on the barely noticed segment of in-train electronic controls, this small segment grew into a sizeable and sustainable firm, turning in healthy profits and growth rates. Clearly, without the leadership of Hannart, Selectron would have been liquidated and its assets sold off. The entire process is detailed in the Selectron company profile.²

Other companies fit a similar pattern. A team of internal and external managers brought **Pilatus** back to a profitable and sustainable growth path. **Burckhardt Compression** was acquired through a management buyout (MBO) and turned into a growing company with healthy returns. Likewise, **LEM** was refocused by a new team on the company's board. **Sécheron** was resurrected by a team of outside managers with deep industry experience who had acquired the company from its financial owners. Due to the importance of this process of resurrection, a special section is devoted to the topic later in the book.

Reflecting on the Background of Founders

Reviewing the list of firms, their founders, as well as the circumstances of their backgrounds, a number of factors stand out.

First and foremost, the founders had in-depth knowledge of the industry or application relevant to their ventures. Many of them, particularly in the earlier phase, gained this expertise through practical apprentice-type programs. Secondly, these founders were young, many of them below the age of 30, and had started with small operations, gradually building them into bigger companies. Most of these founders came from modest financial backgrounds.

A second group of founders leveraged their industry experience gained through businesses selling to a particular target industry segment. They capitalized on their

²Adapted from Selectron company profile.

realization that improvements to the status quo would sell well. To make up for a lack of engineering or technical skills in manufacturing, they often teamed up with gifted and experienced engineers to bridge the gap. Drawing on financial resources available from their previous careers, this group of entrepreneurs was able to acquire firms that had gone into bankruptcy.

Teams, taking over operating companies in financial distress with an interest in putting them back on a growth path, had accumulated considerable industry and management experience prior to taking over the distressed firm. Those teams usually had a technical background as well. Since such developments occurred in more recent times, their technical training was often university-based rather than stemming from practice-oriented apprenticeships.

And Women?

Scanning the list of the founders from the 36 companies researched, the reader will quickly notice the absence of any women. One possible explanation is that exporting companies often dealt with technology products requiring engineering and manufacturing skills. Traditionally, few women were found in those occupations. Another explanation is that some of the companies researched began operations a long time ago. This naturally disadvantaged women who only in recent years have become represented in larger numbers within these occupations. However, there were some remarkable examples of women found in the research who played significant roles in building companies upon the death of their founder husbands.

A leading role was played by the widow of a company founder relating to the oldest documented company, **Sefar**. The company was founded by Pierre Dufour in 1833 as a silk gauze weaving operation. When the founder died unexpectedly in 1842, he left the company to his 25-year-old widow, Anne-Joséphine Dufour-Onofrio, and their infant son. Like her husband, Mrs. Dufour came from Lyon and her family was also in the silk business there. Contrary to everyone's expectation that she would return to Lyon, she instead took over the company and remained in the small town of Thal in the St. Gallen Rhine Valley. Under her management, Dufour & Co. grew to become the dominant silk gauze weaving company, employing more than 1000 people at the time of her death at the age of 84, in 1901.³

In many firms, spouses and daughters played significant roles behind the scenes, sometimes assuming operation roles or by supporting major investments involving family resources.

At **Plaston**, efficient operation of an injection molding machine demanded uninterrupted 24-h use. The four-member start-up team taking up this challenge, in addition to founder Hans Frei, included his wife Sofia, son Roland and daughter Madlen. Father Hans and son Roland would run production and sell products while

³Adapted from Sefar company profile.

Sofia and Madlen handled the bookkeeping and looked after the machine during breaks.⁴

As companies matured and initial founders stepped down, in a number of instances, daughters assumed leadership roles as board chairs. Such was the case at **Caran d’Ache** and **Kuhn Rikon**, or they became board members, as was the case at both **maxon** and **Fraisa**.

Open Access This chapter is licensed under the terms of the Creative Commons Attribution 4.0 International License (<http://creativecommons.org/licenses/by/4.0/>), which permits use, sharing, adaptation, distribution and reproduction in any medium or format, as long as you give appropriate credit to the original author(s) and the source, provide a link to the Creative Commons license and indicate if changes were made.

The images or other third party material in this chapter are included in the chapter’s Creative Commons license, unless indicated otherwise in a credit line to the material. If material is not included in the chapter’s Creative Commons license and your intended use is not permitted by statutory regulation or exceeds the permitted use, you will need to obtain permission directly from the copyright holder.



⁴Adapted from Plaston company profile.

Part II

Governance Practices

This research demonstrated that the nature of governance plays an important role in the development of an SME. Governance practices are analyzed accordingly, from both the structural, or statutory, perspective, in addition to the perspective of the interface between company board, owners, and management. These three chapters offer a full range of the approaches adopted and give significant detail about the workings of governance for many of the SMEs covered in the book.

- **3 Ownership Structures**

How ownership structures evolved are covered in the chapter, starting from the early stages and unfolding over time as ownership invariably passed on from one generation to another. Examples are offered about how, and under what circumstances, companies go public and how their founders recruit new owners when they are ready to pass on the company.

- **4 Achieving Ownership Stability**

Stability of ownership is a big issue among SME owners and companies have engaged in a number of strategies to preserve and guarantee ownership stability. The various perceptions of company management regarding independence and autonomy are elaborated upon in this chapter.

- **5 Boards and Governance**

Company boards play a big role in the governance of SMEs and different models are traced from family boards to foundations, as well as the impact of dual board structures, which is frequently adopted.



Ownership Structures for Stability and Control

When founded, the vast majority of the companies in the sample (26 out of 36) were launched as single ownership entities using a variety of legal formats, from single proprietorships to incorporated stockholding companies. Over time, as the initial founders passed away, all of these firms eventually migrated into other forms of ownership, mostly involving groups of investors or successor families.

Of the remaining ten firms, eight were founded as different forms of partnerships, or groups of owners getting together to jointly own a firm. Again, most of these firms, after some time of operating in a partnership format, experienced that one or the other of the partners ended up shouldering the total responsibility, buying out the other interests. Over time, these firms also changed their ownership structures into a series of different formats, ranging from family companies to public ownership. Two of the ten were founded as family companies from the outset. They involved two generations of ownership from the beginning and remained family-owned to this day.

The desire to control the companies through stable ownership was a central theme in the interviews with current owners or managers. There was an overriding concern that if a company was sold, the core of its operations might be dissipated, or that new owners might not have the same interest as the previous generation in maintaining the company in its present format. This should not be interpreted as being opposed to any ownership change at all. Rather, owners carefully planned any changes, if possible, and wanted to be intimately and personally involved in the selection of new owners who would continue the tradition of the company.

From Single Ownership to Family Company

There is a natural and inherent risk in a change of ownership once the founder steps down or passes away. Of the 26 firms founded as single ownerships, 13 companies managed to preserve majority ownership through the founders' descendants. Of those companies moving to other ownership forms, four of them were acquired by private investor groups, seven became public firms, and three were transitioned to new corporate ownership structures; for example, they were acquired by other firms and thus ceased their legal independence while continuing to operate.

Given that independence was viewed as a guarantee for survival over the long term, how then did the firms who preserved ownership manage to maintain this status, in some cases over several generations? The chosen strategies were invariably impacted by company circumstances, as well as by the capital market options available at the time of generational change. The following five examples represent long-lasting firms, founded more than 100 years ago, in addition to some that were founded more recently. The details published here can also be followed in the company profiles devoted to the 36 companies at the end of this book.

Family Ownership for the Long Term

Few companies can look back on a more storied history than **Sefar**. Founder Pierre Dufour (1799–1842), originally from Lyon, France, started his gauze silk weaving business in Thal, located in the St. Gallen Rhine Valley, in 1833, under the name of Dufour & Cie. When he died suddenly, after returning from a business trip to the United States, it was his widow who took charge to keep the business in the family:

At the time of her husband's death, Anna Joséphine Dufour-Onofrio (1817–1901), had been married for two just years and was left with their infant son barely one year old. Although Mrs. Dufour, now a single mother of 25, who had moved two years earlier from Lyon to Thal and shown a strong interest in her husband's business, was nevertheless expected to return to Lyon with her son Antoine (1841–1889). However, Mrs. Dufour remained in the small village of Thal and assumed management of the company employing about 50 home-based weavers and, presumably, a similar number of employees for preparing the yarn, shipping and general office work. At the 1855 World Exhibition in Paris, Dufour-Gauze was awarded the first-class silver medal. But "Madame Dufour," as she was typically called, not only possessed exceptional entrepreneurial and commercial skills, but was also active in the local women's association, had a hospital built and enabled a workers' support and pension fund.

When Mrs. Dufour realized that her son did not show sufficient enthusiasm for the business, she actively began to groom a potential successor. Christoph Tobler (1838–1907), son of a local farmer, had joined the company in 1855 as an apprentice. Joséphine Dufour appreciated the bright, diligent and eloquent young man and entrusted him with more and more managerial tasks. In 1872, when a partner retired from the company, Christoph Tobler received a share in the profits and in 1890, after the death of Antoine Dufour, he became a co-owner of Dufour & Co. His brother, August Tobler (1884–1906), also became a managing director and co-owner. While Christoph Tobler traveled the world in search of new customer contacts, August Tobler worked in the company in Thal. Christoph Tobler had 16 children of whom five held senior positions in the company. In 1901, when Joséphine

Dufour-Onofrio died at the age of 84, the Toblers had become co-owners of the company then employing around 1000 people. The company continued to operate as Dufour & Co. for several decades until merging into **Sefar** in 1995.¹

Additional detail about how Sefar remained in family ownership over the decades are included at the end of this chapter.

As had happened to the Sefar family, the founder of **Kuhn Rikon** died just a few years after the company was founded. Having left the business to his widow and two teenage sons, who were willing to enter the business under the guidance of the family, family ownership of the company was thus extended for decades.

When Kuhn Rikon founder Heinrich **Kuhn** died in 1932 at the age of 55 of a brain tumor he left his business to be managed to his two teenage sons, Henri age 18 and Jacques age 14. The business had grown to include some 50 employees. His wife inherited ownership, which was later transferred in equal proportion to her two sons, Henri and Jacques. The elder son Henri died early in 1969 at the age of 55, passing on his 50 percent stake to his wife (25 percent), and the other 25 percent in equal shares to his four children.

The situation was different with the 50 percent ownership of Jacques Kuhn (1918–2017) who did not marry until very late in his life and did not have any children. He bequeathed his 50 percent stake in the form of a pre-inheritance to Henri's daughter Rosanne, who married Wolfgang Auwärter, later to become CEO of Kuhn Rikon. Combining her two inheritance stakes led to majority ownership for the Auwärter-Kuhn branch of the family. When Auwärter stepped down from the board, his daughter Dorothee Auwärter, a lawyer by training, assumed the position of board chairwoman. "You must have somebody with a clear majority" believed Wolfgang Auwärter.²

Owned by the Same Family Over Multiple Generations

Successive generations of **Geistlich** family members retained ownership of the company and were also actively involved in its governance, thus keeping the business in family hands for 150 years.

Heinrich **Geistlich** founded his bone processing company in 1851 near Zurich. Upon his death, his son Eduard Geistlich took over in 1864. Eduard's sons transformed the company in 1909 into a shareholding company with shares owned by Geistlich family members. Over its entire history, Geistlich remained a private company owned by Geistlich family members and their descendants. The Geistlich shareholding group comprised about 40 family members with a shareholder agreement in place. The group met for a general assembly once per year. Since the retirement of Peter Geistlich, no Geistlich family member was active in operational management. Both boards, for the holding company and for Geistlich Pharma, included Geistlich family members, with the present chairman, Andreas Geistlich, nephew of Dr. Peter Geistlich (1927–2014) who had acted as the prime mover of getting Geistlich into the field of bio regeneration. The company owners were committed to a strategy of independence.³

¹Adapted from Sefar company profile.

²Adapted from Kuhn Rikon company profile.

³Adapted from Geistlich company profile.

The Effort to Keep the Business Within the Family

As already witnessed, the death of the business founder challenges the owning family to find a suitable succession while still keeping the business in family control. At **Plaston**, this was only possible by inviting some non-family investors to join while keeping majority ownership in the family.

Plaston founder Hans Frei founded his business in 1956 at the age of 55. A first generational change took place in 1973 with the retirement of the founder who had seven children. Hans passed away in 1977, and his son Roland took over management. Roland became CEO and ran the company until 1999.

Until 1990, Plaston remained entirely family-owned. The strategic objective was to restrict shareholding to those who would or could have a direct influence on the company's future success. As a result, it was decided to purchase the shares of the four sisters of Roland Frei. The newly available shares, representing 35 percent of the capital, were then re-sold to seven members of management acquiring 5 percent each. This move was designed to strengthen awareness around the mutual goals of keeping Plaston on the road to success.

In 2004, Roland Frei needed to repurchase shares owned by management. To obtain the necessary funds, Plaston decided to go public and to list its shares on the secondary market. The Frei Family still held over 54% of the shares, with the rest held by management and a small group of outside investors. In 2013, Roland Frei's son, Jörg, became chairman of the Plaston Board, thus representing the third generation of the Frei family at the helm of the company.⁴

How Two Families Preserved Combined Ownership for the Next Generation

When several families engage in a business together, it becomes an even greater challenge to keep the business in the family and to pass it on to the next generations. At **Sylvac**, the owning families managed to do just that while changing the ownership shares at the same time.

Sylvac, started in 1973 by Hans Meyer developing electronic modules for two local firms. Schnyder & Cie was founded by the younger Urs Schnyder in 1969 as a producer of delicate precision modules supplied to Sylvac and its customers. The two families were indirectly related through marriage and had known each other for a long time. The close collaboration of Sylvac SA as development and sales arm, and Schnyder & Cie as the manufacturing arm, continued for about 25 years to their mutual benefit. Sales increased steadily, from about CHF 2 million in 1989 to CHF 20 million in 1998. It weathered changes in management, when the sons of Urs Schnyder, Eric and Jacques, joined that business, and at Sylvac, when management passed to Daniel Liechti, son-in-law of founder Hans Meyer and brother-in-law of Hans-Ulrich Meyer, son of the founder.

The founders of the two companies wanted to make sure that the future was in the hands of their 2nd and 3rd generation and in 2006 decided to merge both companies into a single entity under the Sylvac name. The transfer of ownership took place at reasonable share prices such that the Schnyder family, with Eric and Jacques, were able to acquire the

⁴Adapted from Plaston company profile.

majority of the shares, with the remainder of the capital in the hands of the Meyer and Liechti families. Jean-Noël Liechti, son of former CEO Daniel Liechti, joined the company to head the IT department. Eric Schnyder assumed the role of CEO and his brother Jacques Schnyder headed manufacturing at Malleray.⁵

Passing Ownership from One Family to Another Family

The history of **Fraisa** is an example of the circumstances under which a family is not able to remain an active owner and, if possible, finds a new owner who is willing to continue the tradition and legacy of the founding family. This may, perhaps, be the best solution to that specific problem.

Fraisa founder Hans Stüdeli started a tool making business in Bellach (SO) in 1934. When he passed away unexpectedly in 1950, his son Hans assumed ownership control and management of the firm. He remained in control for almost 40 years until retiring at 75. He turned over the company and ownership to his two daughters and their families, the Schibli-Stüdeli and the Fröhlicher-Stüdeli families. While the two daughters were loyal to the business, neither had a technical background. At the age of 84, Hans Stüdeli convinced the family to sell the company to the CEO, Josef Maushart, who had been with the firm for many years. With the Maushart family acquiring control of Fraisa, ownership passed into the hands of a second family who had an interest to continue to run the business as a family company. The Stüdeli families allowed this to happen through internal financing and an earn-out based on company cashflow. The transfer of ownership took place in 2005 and the descendants of the Stüdeli family continued to serve on the Fraisa board together with representatives of the Maushart family.⁶

Passing Ownership Through a Succession of Three Different Families

What happened at Fraisa once also occurred at **Acutronic** twice. Each time the new Acutronic owners treated the business as a family company and took care that the next owners would do the same.

Since Leo Marxer founded **Acutronic** in 1973, the company had always been a family company. In 1996, Thomas W. Jung, at the age of 30, bought the company from Leo Marxer. Thomas Jung had a family business background and had previously worked for DaimlerChrysler Aerospace in Munich. Partly for family reasons, and because he was attracted by the challenge to run his own business, he decided to move back to Switzerland and buy the financially distressed company. The takeover was largely financed by money from his family.

In 2015, after almost 20 years with Acutronic, Jung sold the company to the Aigrain family due to the lack of a potential successor within his family. Thomas W. Jung could have sold the company to a private equity fund or to a corporate owner, but he preferred to keep the company in private hands. Because of the private ownership, management enjoyed

⁵Adapted from Sylvac company profile.

⁶Adapted from Fraisa company profile.

greater independence than as a public company. By selling the company to private owners, Jung explicitly tried to preserve the strategic focus and identity of the company.⁷

Going Public to Assure Succession

At **Bachem**, founder Peter Grogg did not have any family members willing to step in to run the company. By resorting to an IPO, he was able to attract and keep professional management while maintaining controlling ownership for his family.

Peter Grogg founded his company **Bachem** in 1971 to serve the growing market for chemicals used in pharmaceutical research processes. Privately held by Grogg, Bachem was listed on the Swiss stock exchange in 1998 when the company had reached CHF 100 million in revenue. The founder retained about 60 percent of the shares. Reasons for the IPO were largely private. For once, there were no family members prepared to enter into an operative role at the company. In addition, founder Grogg was said to always have had an interest to run a publicly held company after having successfully started a privately held firm.

Top management, who had always been granted shares by Grogg, experienced real value for their holdings as a result of the IPO. To avoid any “short-termism,” senior management indicated that a company needed anchor shareholders committed over the long term. Founder Grogg with his controlling stake in the company clearly fit that stabilizing role. Grogg retired from the board in 2011 to become Honorary Chairman. The board was now chaired by an outside Chairman, with Grogg’s daughter in the role of vice-chair.⁸

Opening ownership to external shareholders offered the benefit of bringing in additional capital to grow the enterprise. By maintaining majority control, the founding families and descendants of the company founders let external investors participate financially in the success of the companies while maintaining their ability to lead the business in the ways that they always had. Listing the shares on secondary exchanges also allowed for some shadow pricing of the ownership stakes, creating an internal market for some of the family owners who decided to sell part or all of their stakes. This financial flexibility combined with continued ownership control was often cited in interviews as a strong motivation to pursue broadening the ownership base.

Employing Shareholder Agreements to Provide Stability

Since almost all companies transferred to stockholding structures as their owners retired or passed away, the preferred method of maintaining control within a close-knit group or family was the shareholding agreement. Many companies used this mechanism to force transactions within the family. A special case was **Sefar** that evolved through several mergers to become a family-owned company involving nine

⁷Adapted from Acutronic company profile.

⁸Adapted from Bachem company profile.

different families. Their process of ensuring long-term family control survived the test of time:

Sefar resulted from a merger of several companies in 1995. The founding families, including the Dufour and the Tobler families, remained owners of Sefar AG. Overall, there were nine families, each owning between 3 and 20 percent of the company. There were transfer restrictions in place and shares could only be sold to members of one of the nine families. The tradability of the shares was ensured via an informal “stock exchange” at a bank. Selected top managers of the company could become shareowners, with their shares reverting to the founding families after their death. In 2018, less than 10 percent of the company was not family-owned.⁹

Similar arrangements were maintained by the three owner families of **Caran d’Ache** where the Hübscher, Reiser, and Christin families dominated the shareholding group, with the Hübscher family being in the 4th generation of majority owner. The descendants of Emil Richterich, founder of **Ricola**, remained the only shareholders of Ricola, now chaired by the 3rd generation, with a 4th generation entering the business as well. Such practices of signing shareholder agreements were common for many of the SMEs studied.

Assuming Founding Partner Stakes to Provide Stability

Of the nine companies documented that started as some form of partnership between two or more entrepreneurs, only **Caran d’Ache** survived as a partnership between its three owner-families. All other companies changed into alternative ownership structures, from reverting to single ownership, becoming a public firm, or being acquired by corporate owners. Buying out a partner presented a delicate task that could cause difficulties. Both **EAO** and **LNS** serve as examples of how to accomplish this successfully.

EAO founders Kurt Loosli (1921–1988) and René Thalman (1921–1993), two schoolfriends, combined their efforts and resources and founded EAO in Olten in 1947, sharing ownership on an equal basis. When co-founder Kurt Loosli passed away in 1988, his widow Dora Loosli inherited the 50 percent stake in the company. In 1993, co-founder René Thalman died, again leaving his widow to inherit a 50 percent stake. The two widows and their families were confronted with what to do about the company. The Thalman family decided they wanted sell, the Loosli family decided to stay in the business. Rather than one family buying the other out, the two families settled on an asset split. To make this work, the Thalman family took all non-core business assets ranging from the real estate and excess liquidity. The Loosli family ended up with the direct business assets but very little liquidity which initially made the running of the divided business difficult.¹⁰

⁹Adapted from Sefar company profile.

¹⁰Adapted from EAO company profile.

At **LNS**, which was started by three partners, ownership evolved over time so that only one of the three owner families remained.

André Léchet, one of the three original **LNS** founders, owned a small workshop in Orvin. For his cousin, he developed a solution for feeding metal bars automatically into turning machines. Léchet enlisted two friends for the commercialization of his solution. First was Walter Neukomm, a tool maker working for Tomos, a large CNC turning machine manufacturer. He brought the industrial manufacturing knowledge to the project. Second, Léchet pulled in Maurice Scemama, owner of a machine tool shop and a gifted salesman selling specialty machine tools and tools to watch industry suppliers. The mechanical genius (André Léchet), Mr. Industrialization (Walter Neukomm), and the consummate salesman (Maurice Scemama) joined to form **LNS** in 1972 with the purpose of commercializing the automatic bar feeding opportunity.

The company commenced operation in 1973, Walter Neukomm was its first CEO until his sudden death in 1979. **LNS** remained a privately owned company with Co-founder Maurice Scemama as board chairman. In 1987, Maurice Scemama's two sons, Philippe and Yves Scemama, started working for **LNS**, and Yves assumed the role of CEO in 1995. Ownership control had remained in the Scemama family and was shared between the two brothers and their sister.¹¹

MBOs to Recruit New Owners

When the interest of founder-owners or descendants in a company waned, the danger increased that a business would go into decline or be sold to corporate or financial owners. When ownership could not assure continued talent to lead, managers within the company may be best placed to guarantee continuation. Existing management was usually familiar with the firm, its technology, and the business environment. External owners, new to all of this, might not bring the necessary understanding. Thus, a number of the documented companies have gone the route of promoting managers to owners and give that management shareholder's rights. This can range from minority stakes all the way to transferring controlling stakes. Such was the path taken by the owners of **Filtrox**.

When Hans Schmid, founder and owner of **Filtrox**, passed away in 1948, just ten years after starting the company, ownership passed to a number of families from the St. Gallen region. However, none of the families had a deep interest in the filtration business and left the company's fate in the hands of management. In 1990, Toni Rusch, who had joined the company a few years earlier and headed **Filtrox** management, had a chance to buy a significant stake from one of these families and become a shareholder. Later, his son Cristian Rusch became CEO of the company. The Rusch family and three other families remained investors, all with a long-term perspective and an interest to preserve the company's independence.¹²

¹¹Adapted from **LNS** company profile.

¹²Adapted from **Filtrox** company profile.

A rather different approach was chosen by Urs Baumann at **Lantal** when he was confronted with the challenge of finding a successor outside of his family.

Urs Baumann's grandfather Friedrich Baumann had started a weaving business in Langenthal in 1886. Urs Baumann's father, Willy Baumann, had separated from that family business in 1951 to create an upholstery weaving business, eventually called **Lantal**. When Urs Baumann wanted to step down from leading Lantal in 2003, he found that none of his family members wanted to continue in active management. Urs Baumann hired a headhunter to find a new manager and, maybe, possible successor for his business. They settled on Urs Rickenbacher who had a background in the furniture business and who, together with some members of management, took over the ownership of the Lantal company through an MBO in 2004. Rickenbacher and his team have led the company ever since, assuring continuity of the business.¹³

At **Burckhardt Compression**, an MBO initiated by company management led to independence from corporate ownership.

Burckhardt Compression could look back on a varied history traversing several ownership formats, from single ownership to subsidiary as part of Sulzer Group. In 2000, a pivotal time for the Sulzer Group, Valentin Vogt was appointed to head Sulzer-Burckhardt. During this period, Sulzer Group decided to focus on four business areas only. Sulzer-Burckhardt and three other business areas were put up for sale.

Vogt and his team concluded a deal with a private equity firm who acquired 78 percent of the shares in the process. The management team kicked in 20 percent of equity and made a deal with Sulzer to acquire the business for CHF 54 million. Vogt was convinced that, once out of the corporate umbrella, where "every management hierarchy costs 2 to 3 percent in EBIT," they would be able to manage on their own far better than being part of a large corporation. As part of the move to separate from the Sulzer Group, the company name was changed to Burckhardt Compression.¹⁴

Reflections on Ownership Models

No single ownership model appeared to dominate. Rather, different firms adopted different models and they appeared to succeed at their chosen model. Surprisingly, a large number of companies migrated from single ownership to family ownership as a result of succession, staying with the family ownership model over extended periods of time. **Geistlich** and **Sefar** are the outstanding examples of this practice. Other companies remained family-owned, but the owning family changed over time. **Fraisa** serves as an example here. Several other companies migrated from one ownership model to another over time, sometimes even reverting to earlier models. Examples of this particular evolution are **Burckhardt Compression** and **Sécheron**. This was sometimes influenced by a new generation of owners, particularly when the new owners were not part of the founder's family.

¹³Adapted from Lantal company profile.

¹⁴Adapted from Burckhardt Compression company profile.

Ownership and providing effective control over the future of the company was of paramount importance to the leadership of all of the companies documented in this research project. Despite the common goal of effective control, the forms of ownership varied widely across the group of firms with various companies taking different routes to get there. Some of the pathways were imposed through fate or history while others were chosen freely. In general, each company leadership appeared satisfied with its chosen ownership model while harboring doubts about the models adopted by others. From the perspective of the other companies, the feeling was often mutual! Whichever ownership model was adopted, the crucial element was that it be implemented carefully and executed faithfully. How this was done in order to provide stability is the focus of the next chapter.

Open Access This chapter is licensed under the terms of the Creative Commons Attribution 4.0 International License (<http://creativecommons.org/licenses/by/4.0/>), which permits use, sharing, adaptation, distribution and reproduction in any medium or format, as long as you give appropriate credit to the original author(s) and the source, provide a link to the Creative Commons license and indicate if changes were made.

The images or other third party material in this chapter are included in the chapter's Creative Commons license, unless indicated otherwise in a credit line to the material. If material is not included in the chapter's Creative Commons license and your intended use is not permitted by statutory regulation or exceeds the permitted use, you will need to obtain permission directly from the copyright holder.





Stability Through Foundations

Some company owners have found that the best way to ensure that their entities continue is to create a foundation that could take ownership of all, or part, of the business. Usually, foundations have a specified purpose which can bind future owner generations to the firm, preventing the business from falling into unwanted hands. The example of **Max Felchlin AG**, below, is probably the most particular of the documented companies but certainly not the only one. Founders at both **Jura** and **Oetiker Group** had placed some of their company stakes into foundations.

Max Felchlin started a honey trading business in 1908 that eventually grew into a bakery and confectionary supply business. He passed on the business to his son Max, Jr., in 1962 who ran it for 30 years. As Max, Jr., was getting on in age, he began to wonder what to do with his company. His two adoptive sons were not active in the business. The company was small but profitable, Max, Jr. wanted to find replacements for his many roles at the company and also a way to separate business control and ownership from the income stream generated. In 1990, he founded the 'Association to Promote Business and Culture in Canton Schwyz,' controlled and supported by Max Felchlin AG.

The structure eventually adopted in 1991 was rather unique. Ownership was divided equally among 1200 shares, each bearing one vote. The bulk of 1000 shares were placed with the 'Association to Promote Business and Culture in Canton Schwyz' who became de-facto owners of the company. The association, with a self-constituted board of five to six persons, was instructed to continue to own and run the company as long as feasible, and to only sell the company if there were no other options. Max, Jr.'s, two sons received 100 shares each. The distribution of the company profits and dividends were also regulated: one third would be reinvested into the business, one third would be for staff and employees, and the remaining one third was for dividend distribution, with 90 percent going to Max, Jr.'s, two sons, Max-Peter and Joe, and 10 percent to the Association for sponsoring local activities. This was the structure Max, Jr., chose to assure that the business would continue.¹

¹Adapted from Max Felchlin company profile.

In the cases where foundations took over company ownership, the principal motivation of all the original owners was to preserve their businesses and ensure that the firms had long lives by removing ownership transfers that could endanger company stability.

Stability Through Private Investors

When the required financing was beyond the reach of a single new owner or investor, a group of private investors, acting in coordination, were sometimes able to assume ownership of a company. This was practiced by two of the documented firms, **Sécheron** and **Pilatus**, who were, at the same time, both in need of restructuring and turnaround management. The firm and long-term commitment of investors assured the company management sufficient time, as well as a longer-term horizon, in order to achieve the needed results and ensure the firms' survival.

Sécheron, a company with a long history, had undergone a series of ownership changes and was suffering from declining results. Eventually, a group of private investors who also understood the business took control and assumed both ownership and management leadership.

Sécheron, founded in 1879 in Geneva, had a long history connected to the electrification of railways. The company went through several forms of ownership, from private owners to public company, and eventually became a subsidiary of a large international firm. When financially driven investors took over, and failed to turn the business around, the Geneva bank BCGE stepped in and took over control in 1995. Soon, BCGE was looking for new owners. There were several interested international companies in the field of railway or energy, but the Geneva bank management favored Swiss ownership.

A group of private Swiss investors then acquired Sécheron from the bank. The partners did not see themselves as a private equity group in the traditional sense, instead they were actively involved in the business and had no plans to sell. Some of these investors had worked on other transformation projects together, in particular under Ernst Thomke, and had gained valuable management experience turning industrial enterprises around. They possessed deep technical know-how in many areas relevant to Sécheron. By investing their own money, the new owners all had 'skin in the game.'

The company remained privately owned and no IPO was planned.

The acquisition was heavily leveraged with financing provided through BEKB and BCGE with a minimum of investor capital required. The top 15 managers of the company were invited one year later to participate in the acquisition and all but one participated. As it turned out, the entire external financing was paid back within four years.²

Pilatus experienced a similar transition from corporate ownership, as a unit of a large company, into private ownership, which had been passed on to the next generation, while engaging enlightened management to run the company.

²Adapted from Sécheron Group company profile.

Pilatus operated the first 60 years of its existence as a subsidiary of Oerlikon-Bührle, the large technology company assembled by Dieter Bührle (1890–1956), founder of Pilatus. This industrial group was inherited by the two children of Emil Bührle, the son of Dieter Bührle (1921–2012) and daughter Hortense Anda-Bührle (1926–2014). When the Bührle conglomerate ran into difficulty in the early 1990s, Hortense Anda-Bührle assumed increasing responsibilities, including a role in Pilatus. Around 1990, Pilatus had run into financial difficulty and was in need of restructuring, which was accomplished with a team led by Ernst Thomke, previously with Swatch.

At the end of 2000, and with its fortunes as a company resurrected, Pilatus was spun out of the Bührle group (renamed by that time UNAXIS). It was acquired by a group of Swiss private investors for a reported price of CHF 250 million. The new ownership group included Jörg Burkart, banker, the Anda-Bührle family and the retirement fund of Roche. The Unaxis company retained a small percentage of the shares. Although the company did not provide details on ownership, it was reported that the Anda and the Burkart families each held about 45 percent of the shares. The initial intent was to bring Pilatus on the stock exchange within four years, which never came to pass.³

Employees Riding to the Rescue

The example of **Selectron**, although the only one among the companies researched, shows that, under the right circumstances, employees might even step in to provide stability for a company that is suffering from neglect from its corporate owners.

When Emmanuel Hannart took over **Selectron**, which had become part of Schneider Group, he continuously faced restrictions from the parent company's staff on his efforts to develop the business into a pure-play for in-train electronic controls. When a sale to another large company failed, he pursued an employee buyout. Working with business contacts and private investors, he and his advisors put together a package for all employees, not just managers, to buy into the company. Schneider Group agreed to sell at the same price previously negotiated with a prospective buyer and to grant the necessary time to put the deal together. Banks, after first balking at the idea of a leveraged employee buyout, agreed to finance about 60 percent of the acquisition price. For the 40 percent equity required by the banks, 75 percent was contributed by a group of international investors recruited by Hannart. The remaining 25 percent came from employees, 80 percent of whom voluntarily decided to invest.

With newly found independence, Selectron continued to grow and new customers were acquired. Growth of 15 percent annually with sound profitability allowed Selectron to keep R&D at 20 percent of sales. The strong business results allowed the company to quickly pay off the bank loans from the leveraged buyout and to eventually refinance the deal at better terms.⁴

The examples and experience of **Burckhardt**, **Pilatus**, and **Sécheron** demonstrate in an impressive way that private owners, particularly those also involved in the business, can outperform corporate owners and rescue companies that were in decline.

³Adapted from Pilatus company profile.

⁴Adapted from Selectron company profile.

Stability as Public Company

Interviews with executives from many of the privately held companies uncovered an unwavering rejection of public ownership, expressing the sentiment that it is inconsistent with how an SME needs to be managed. Most owners and managers deliberately avoided being on the stock market because they feared a loss of strategic control of the firm and short-termism—the pursuit of short-term financial goals over long-term strategic objectives. This negative view, however, was not shared by publicly owned firms, although there were cases where the leadership of public firms referred to the share price as an issue that produced pressure.

Five public companies (**LEM**, **Burckhardt Compression**, **Komax**, **C+M**, **u-blox**), demonstrate that, under the right conditions, public ownership does not have to be a disadvantage.

C+M had a long experience as a semi-public company being listed on a secondary regional stock exchange. This listing provided the long-term owning families, in particular, with some liquidity while still preserving private ownership, similar to the strategies witnessed at **Sefar** or **Plaston**.

Founded as a partnership in 1885 and incorporated in 1924, **C+M** had always been a shareholding company with a small set of shareholders at its core. Stock market research indicated that the company ownership included seven larger and 260 small shareholders, with larger shareholders collectively accounting for a controlling interest. Some of the earlier founding families were reported to still be part of the core shareholding group. **C+M** shares were listed on the local Bern stock exchange trading as OTC shares. Using this type of listing allowed for some transactions among owners without leading to instability of ownership.⁵

LEM had long been a fully listed public company; its initial listing dated back to 1986.

At **LEM**, the public listing was viewed as a positive force by management. The transparency required for a public company brought increased discipline and there was a certain “window effect” that made management work harder since results were clearly measured. Governance was of course driven by Swiss stock exchange requirements. What was important for **LEM** was its stable set of shareholders. Two core family shareholders accounted for slightly more than 50 percent of shares. This brought stability to the company.

Being a public company listed on the Swiss stock exchange, **LEM** had access to capital, if ever needed. With a steady cash flow of more than 10 percent of sales, the company was in a position to finance its capital needs from internal resources. The healthy profitability of 24 percent in total annual shareholder return during a recent period allowed for a targeted dividend payout ratio of in excess of 50 percent, appreciated by its shareholders.⁶

At **Komax**, the fact that the company was listed on the Swiss stock exchange was also not viewed negatively. While accepting that, as a public company, there was

⁵Adapted from **C+M** company profile.

⁶Adopted from **LEM** company profile.

more pressure for short-term performance, management still felt that the privately held companies had an advantage, as long as the ownership was pulling in the same direction.

Started as a single proprietorship by entrepreneur Max Koch in 1975, **Komax** became a limited company (AG) just three years later. In 1996, founder Max Koch, at the age of 47, sold 80 percent of his shares to management and a private equity company as part of an MBO. At that time, Komax had sales of about CHF 120 million and a workforce of 365. One year later, the company went public with a listing on the Swiss exchange. The company founder remained the largest single shareholder with a holding of about 5 percent. Shares were widely held, and the free float amounted to more than 90 percent. Shareholders were mostly Swiss investors.⁷

Through its stock market listing, Komax had access to additional capital if needed. Over its history, the company could rely mostly on its self-generated cash flow and turned to external debt financing through banks for only a small part of its capital needs. Its financial performance allowed for a constant investment of about CHF 20 to 25 million and a targeted dividend payout ratio of 50 to 60 percent of earnings after tax.

Running a private company allows for more long-term thinking than a public one, but only if all owners are on the same page. As a public firm listed on the stock exchange, the required transparency and visibility leads to higher and more short-term pressure on performance (Kälin, CEO).⁸

The issue of transparency and performance was mentioned by a number of company managements in this research. All of the public companies included appreciated the higher transparency, and performance comparisons, driven by the reporting required of a listed company. It has been noted, however, that at least two privately held companies—**Geistlich** and **Sefar**—management was using either International Financial Reporting Standards (IFRS), **Geistlich**, or Swiss Accounting and Reporting Recommendations (GAAP), **Sefar**, to report to ownership anyway. This supports the view that there were true benefits to the reporting mechanisms of a public firm and that they were also of great use to a privately held company.

That public ownership can be more stable than private equity (PE) was experienced by **Burckhardt Compression**. After a successful MBO and outstanding business performance, the PE investors wanted to exit. At that time, going public was judged to be the best way to replace the capital originally provided by the PE firm. In the eyes of company management, a shareholding contract and a reliable core of loyal investors provided the needed stability.

Four years into **Burckhardt Compression**'s MBO arrangement, the private equity firm Zurmont was itching for an exit. The acquisition of originally CHF 54 million had reached a valuation of CHF 280 million by their account. Under those circumstances, several options were evaluated: finding another private equity firm that would be able to take over Zurmont's stake; approaching another larger compressor company as a strategic buyer; approaching a private investor and, finally, doing an IPO on the Swiss stock exchange.

⁷Source: *Bilanz Magazin*, 1 December 1997, p. 170.

⁸Adapted from Komax company profile.

The management team that had initiated the MBO from Sulzer Group decided on an IPO, because the financial situation of the company was sound, and the fact the private equity firm wanted to sell its entire stake of 78 percent, an amount that would have proven difficult for a single private investor to raise. The IPO was completed in 2006 and resulted in a market capitalization of CHF 280 million. A few years later, capitalization was to reach CHF 1 billion.

Stability in ownership was maintained through a binding contract among the five founding shareholders controlling about 18 percent of shares following the IPO. Valentin Vogt, Chairman of the Board, believed that a public company always required a set of core investors who were committed for the long-term: *Particularly US investors like the clear and single-minded business purpose of a company such as Burckhardt Compression* (Vogt, Chairman and CEO).⁹

The short-term interest of private equity shareholders was also experienced at **u-blox**. Initially started with indispensable PE help, the company management eventually had to face the fact that there were limits to that type of financing. A successful initial public offering (IPO) on the Swiss Stock Exchange provided the needed capital for growth at the risk of dilution for the founders.

When **u-blox** was founded by a group of three student founders and their professor, financing came from a group of friends and family members. Soon, however, the private equity firm Partners Group (Zug) joined as a major investor. The investment was made as a result of the founders circulating an aggressive business plan in 1998 to entice investors. Following initial orders, the company was also able to attract the UK investment company 3i as investor.

The loss of a key customer and the resulting financial losses meant that the UK investor declined to further invest needed capital. At this time, new investors could not be found. Through capital write-downs and restructuring, the company could return to positive business results in 2004 which allowed the company to raise one last capital injection from Partners Group, and to IPO the company successfully on the Swiss Exchange in 2007. During this period the shareholding of Partners Group declined from a high of 45 percent prior to the IPO to a much smaller percentage afterwards. Both governance and management combined held less than 5 percent of all outstanding shares. Currently, leading shareholders were institutional investors, such as Blackrock, CS and UBS funds.¹⁰

u-blox represents one of the classical start-up ventures availing itself of professional private investment funds. This rapid and substantial capital injection was beyond the means of the initial founders. Its aggressive growth could neither be funded through internal resources nor through private investors. However, its institutional investors did not represent the kind of stable shareholders enjoyed by other public companies in the sample, such as for **LEM** or **Burckhardt Compression**.

⁹Adapted from Burckhardt Compression company profile.

¹⁰Adapted from u-blox company profile.

When Ownership Stability Fails

A lack of stability in ownership can have negative implications for the development of a company. This can be seen most dramatically for **Sécheron**, as well as for smaller firms such as **Plumettaz** and **Selectron**. Family members at **Plumettaz** wanted to exit and were looking for a PE entity that would assume a majority stake in the company. The arrangements with the first PE firm did not work out satisfactorily and the company needed to go through the process once again to find stability.

Up to 2008, for almost 80 years, **Plumettaz** had remained a family-owned company with more than 40 family-related shareholders. Most of the Plumettaz family members involved in the business had been engineers. However, only a few family members were active in the business. When Gérard Plumettaz retired at age 65 in 2008, a private equity firm took over 70 percent of the share capital. A holding company was created that held all assets and the PE firm appointed an outsider as CEO. However, the appointment did not work due to cultural differences with a CEO that came from a large company. Two years later, in 2010, the PE company invited the family under the leadership of Denis Plumettaz, cousin of Gérard, back into management. A different PE firm has since acquired the majority stake and a new CEO from the outside was recruited. Long-term stability in ownership has not yet returned to the company with financial return concerns remaining at the forefront.¹¹

The experience of **Sécheron** turned out to be more painful and the company underwent considerable ups and downs as a result of several ownership changes, passing from one set of owners to another. Even emerging from corporate ownership did not work out initially; it was only after a private group of owner-managers invested in the business that a turnaround was achieved, and growth resumed.

Sécheron became involved in the electrification of the Swiss Federal Railway network. During the post-WWII period, Sécheron experienced healthy growth, was profitable and by 1963 reached employment of 1700 and sales of CHF 55 million. Soon, however, new order take-in began to decline, because Sécheron could not accept new orders with very short delivery time. Difficulties prompted the company to engage in merger talks with several suitors, both Swiss and foreign. Brown Boveri & Cie (BBC) was the leading electrical equipment and power generation producer in Switzerland and itself a large international company. By that time, employment at Sécheron declined to about 1250. By all accounts, the integration of the two companies was fraught with difficulties but possibly saved Sécheron's survival as an entity. Under BBC, Sécheron could profit from orders for Swiss locomotives. By 1979 sales reached CHF 120 million and employment was still at 1200.

The merger of Sécheron's parent company, Brown Boveri, into Asea Brown Boveri (ABB), in 1988, brought substantial changes and a radical restructuring of Sécheron by separating the businesses into two companies. The now re-named ABB-Sécheron took the transformer business, the largest part, leaving Sécheron SA with the DC traction components and DC traction power substations.

ABB Group, the new owners, divested the activities and product lines of power supply substations and traction components. ABB sold 80 percent of the remaining business to a Geneva holding company, controlled by an owner with a financial but not an industrial or

¹¹ Adapted from Plumettaz company profile.

technological background relevant to the Sécheron business. At the time of the spin-off in 1989, Sécheron SA was down to just 180 people and sales of about CHF 25 million.¹²

The experience of **Sécheron** demonstrates what can happen to a firm when it leads technically but allows neglect to set in; when owners do not bring anything to the table beyond their financial expertise and competitors begin to take market share away. The ownership changes, stemming from the mergers also added to the difficulties. It was only through the initiative of the investor group Transition Partners that the firm was resurrected and once again put on its growth path.

The history of **Selectron** has been touched on previously while describing the firm's employee buyout. However, before the buyout, the company had become an unwanted business as the firm had passed through three sets of ownership. The sudden turns that can happen at larger corporations, often triggered by management change, put Selectron at risk, resulting in a steady downwards spiral of its business.

Selectron was founded in 1956 by a local entrepreneur from Lyss, capitalizing on the transition from mechanical machine and equipment controlling to electronic controls. By 1992, sales had grown to a high point of CHF 30 million. Employment had reached 175, with more than half dedicated to the manufacturing operation. With changes in technology and the arrival of international competitors, sales began to decline and by the end of the 1990s were only half of its peak volume. The owner, facing losses, decided to sell.

The company which acquired Selectron in 1998 was SIG, a larger Swiss industrial company. SIG had built up its packaging and bottling technology unit with the aim of building its own motion control and automation tools. In the same year, SIG acquired a German company, Berger and Lahr, in the field of motion control and assigned Selectron to report to that firm which had about Euro 100 million in sales. Difficulties soon arose when the two companies attempted to integrate their two control systems and software languages into a single system. Within two years, SIG changed its strategy and abandoned development of its own control system and instead to source controls from the open market. There was no use anymore for Selectron within the SIG group.

This change in SIG strategy put the German company on the block. In 2001, Schneider Electric, a global French firm and a major player in low and medium voltage circuit breakers, as well as in automation components, was interested in combining its product line with Berger Lahr. Given earlier experience with merging program languages from different producers, Schneider was not interested in the Selectron business. SIG, however, would only sell the German company if Selectron would be part of the deal. In the end, Selectron became an unwanted subsidiary of Schneider.

The new French owners had no interest in its technology, nor were there any synergies to its business. In the meantime, sales at Selectron had declined to a mere 11 million and losses continued to mount. Left without a suitor to buy the operation, Schneider decided to liquidate the company instead.¹³

Selectron is an example of what happens to smaller units when they are made part of larger companies. Eventually, the company was saved by an entrepreneurial manager and his team who bought the business from the corporate owner and made it a major player in its field. Neglect, whether technological or otherwise,

¹²Adapted from Sécheron company profile.

¹³Adapted from Selectron company profile.

results in the rapid deterioration of a business. It is this fear of losing control over a company's destiny that drives so many SME owners and founders to look for stable ownership under which their business can be developed with a long-term strategy perspective.

In 2015, a few years after the successful employee buyout, Selectron let itself be acquired by another larger company, the German Knorr Group. Knorr was interested in acquiring the Selectron train control system, or TCMS, because the company became convinced that this would become the central nervous system of new train generations. Adding this component to Knorr's break business was considered a strategic advantage.

Because of the technological and strategic importance of TCMS, Knorr offered to make the **Selectron** unit its own future TCMS developing unit, making Selectron central to Knorr's future strategy and allowing for operational autonomy to continue with its chosen direction. Hannart and his team were able to convince Knorr to make this acquisition not a merger, but to put it on the basis of "concordance," or mutual agreement of governing issues and with operating autonomy.¹⁴ Hannart convinced his investors and employees that this was a unique opportunity and that Knorr would be a better owner than Schneider, or ABB could have been, and less of a competitive threat to Selectron's existing customer base compared to selling out to a major train builder.¹⁵

Independence Versus Autonomy

What emerges here is that control or independence are just two elements of a larger puzzle. Yes, SMEs perform better when their management is in charge of their company's own destiny. Ownership independence appears one way to assure this. But there is also something to be said for autonomy. If a company, when part of a larger group, can be assured operational autonomy, the results may be the same as those with independent ownership. Experience says, however, that larger companies are consistently unwilling, or unable, to grant such autonomy, thus smothering the smaller businesses and eventually driving them into underperformance. The early histories of Sécheron, Selectron, and Pilatus all attest to this reality.

¹⁴The term "concordance" was derived from German "Konkordanz" to describe the particular governance system used in Switzerland involving all major parties and striving for consensus, rather than being overruled by a dominant party as in "Dominanz" model. This model had been adopted in Switzerland by many civic and business organizations as a governance model.

¹⁵Adapted from Selectron company profile.

Open Access This chapter is licensed under the terms of the Creative Commons Attribution 4.0 International License (<http://creativecommons.org/licenses/by/4.0/>), which permits use, sharing, adaptation, distribution and reproduction in any medium or format, as long as you give appropriate credit to the original author(s) and the source, provide a link to the Creative Commons license and indicate if changes were made.

The images or other third party material in this chapter are included in the chapter's Creative Commons license, unless indicated otherwise in a credit line to the material. If material is not included in the chapter's Creative Commons license and your intended use is not permitted by statutory regulation or exceeds the permitted use, you will need to obtain permission directly from the copyright holder.





Governance Arrangements

As companies moved from single proprietorships into other ownership forms involving families, partners, and at times outside investors, or as they became public companies, governance arrangements started to increase in importance. According to Swiss law, incorporated companies, which all of these companies invariably turned into, require the establishment of a board of directors. Its role and duties are set by the Swiss Code of Obligations,¹ which will not be discussed in the context of this book. However, there are many ways how a board can be tasked to supervise a company. With board members elected by a company's general assembly of all shareholders, the role of that body needs to be examined.

Board Composition at Public Companies

The board composition exerts a major influence, whether or not a company is public and regardless of its shareholder structure. Companies listed on the Swiss Stock Exchange are governed by those regulations and are also subject to the creation of board committees, just like any other large public company. Among the companies researched, this affected **Bachem**, **Medartis**, **u-blox**, **Burckhardt Compression**, **LEM**, and **Komax**. These companies were, in principle, required to select a board of external or internal members, or both. However, the requirement that the audit and compensation committees be composed of independent board members made a number of several external board members mandatory.

- At **Medartis**, founders and majority shareholders Straumann and Miesch were board members, together with five additional external, and independent,

¹Swiss Code of Obligations No. 716.

members. Medartis external board members came from a broad range of relevant backgrounds—medical, technical, and investment.

- At **Bachem**, company founder Peter Grogg served as Honorary Chairman; his daughter was also on the board. The other board members were external members with a variety of backgrounds—management, biotech, chemistry, and legal.
- At **Komax**, founder Max Koch, although still the largest shareholder with about 5% of the shares, was not represented on the board, which was composed of six nonexecutive members with divergent backgrounds, including technology, legal, and accounting. The chairman, Beat Kälin, was a former Komax CEO. The company complied with Swiss regulations by maintaining both audit and remuneration committees.
- **LEM**, a public company since 1986, had a board of six nonexecutive members. The company founder, Jean-Pierre Etter, was no longer a member of the board. One of its members represented a large shareholder holding about 50% of the shares. The company had three board committees, including the required audit and compensation committees, plus an additional strategic committee.

What was important to note for **LEM** was its stable set of shareholders. Two core family shareholders accounted for slightly more than 50 percent of shares. This brought stability to the company and did, as a result, raise the importance of the board chairman interfacing between shareholders and management in terms of monitoring performance.²

- **u-blox** started with external shareholders from the outset and went public in 2007, just 10 years after it had been founded. Since the founders and governance accounted for only about 5% of shares, the board structure reflected the requirements of the Swiss exchange. Although all three company founders remained in operational roles at the company, only one of the three founders, plus the CEO, were represented on the board. All the others were nonexecutive members.
- **Burckhardt Compression**, public after the MBO from Sulzer Group, maintained a small board with five members. The board chair, Valentin Vogt, was also a member of the MBO/IPO shareholder pool which still controlled about 18% of shares and thus represented the largest single investor group. The other four members were independent board members. Shares were widely held, but a core group of shareholders did exist.

With 78 percent of the shares now on free float on the Swiss stock exchange, governance at **Burckhardt Compression** had to reflect requirements of the investor community and stock market regulations. Outside investors, particularly some from the US, were attracted by Swiss companies who maintained a sharp focus in their business and had a clearly articulated business model.

Ownership stability was maintained through a binding contract among the five founding shareholders, controlling about 18 percent of shares following the IPO. Vogt, Chairman of the Board at **Burckhardt Compression**, believed that a public company always required a

²Adapted from LEM company profile.

set of core investors who were committed to the long-term. *Particularly US investors like the clear and single-minded business purpose of a company such as Burckhardt Compression (Vogt, Chairman and CEO).*³

Board Roles in Family-Owned Companies

In companies with long-term family involvement, sometimes over several generations, the families played more the role of owner than of owner/manager. In the case of **maxon**, the Braun family, in their role as owners, played a dominant role, with Karl-Walter Braun working as the main decision-maker; his two daughters were also shareholders of the firm. Involved in the firm since close to 1975, Braun also had operational roles in the past and continues to stay very close to the business. Braun chaired both the holding company and the operating company.

Along the same vein was governance at **Thermoplan**. The company's board included founder and majority owner Domenic Steiner and his wife, the company CEO Adrian Steiner (no relation to founders), who was able to acquire a 20% stake in the firm and one external member. In the case of **maxon** a long-time former CEO also became a shareholder. However, in both of these two firms, transfer from the founder to the next generation had not yet taken place.

Board composition in firms that had already undergone transitions to later generations of owners naturally became more complex. It was possible to track three of these firms and see how their boards evolved over time, namely **Sefar**, **Caran d'Ache**, and **Plaston**.

In the case of **Sefar**, which had grown to include nine families as owners, board composition and governance had evolved over an extended period, to ensure both stability and, at the same time, include a mechanism to monetize shares if a family member so desired.

At **Sefar** AG, nine families owned between 3 and 20 percent of the company. Each family had one representative on the board irrespective of their ownership share, so that every family had the same level of information and insight into the activities of the company. There were transfer restrictions and shares could only be sold among members of one of the nine families. The tradability of the shares was ensured via an informal 'stock exchange' at a bank. Selected top managers of the company could become shareowners, with their shares reverting to the founding families upon their death. In 2018, less than 10 percent of the company was not family-owned.

Once a year, an event for the members of the owner families was organized so that everybody got to know each other, was inspired and developed an emotional relationship to the firm. Younger family members would consciously be prepared to inherit shares one day. Doing so, Sefar tried to strengthen shareholders' attachment to the company, even if no family member worked directly in the company anymore. In addition, Sefar made sure that there was always an attractive dividend.⁴

³Adapted from Burckhardt Compression company profile.

⁴Adapted from Sefar company profile.

At **Caran d'Ache**, with several families also sharing ownership over a long period of time, considerable effort was exerted to awaken and maintain the interest of younger family members and to ease the path toward the next owner generation. This was complicated by the fact that the owning families always played an active role in management.

With the retirement of Jacques Hübscher, Jr., in 1997, as CEO of **Caran d'Ache**, the long reign of three generations of Huebschers as CEO came to an end. For the first time, the company was managed by a CEO without any connection to the three owner families. It proved difficult to find a person who would fit into a family business and still assume the role of CEO. In 2011, Jacques Hübscher, Jr., after serving on the board for 30 years, chose to step down and his daughter Carole Hübscher assumed chairing the board. She had been a board member since 2002, working closely with her father.

Governance at Caran d'Ache rested with the board of directors, with the three owner families as members: two from the Hübscher family and one each from the Reiser and Christin families. In addition, three external board members with relevant experience in finance, innovation and luxury branding complemented the board.

As chairwoman and representing the 4th owner generation, Carole Hübscher felt it was important for the owner families to maintain the passion for the business and not just play the investor roles. She considered private ownership a substantial advantage for the independence of the firm. Financial independence allowed the pursuit of the strategy Caran d'Ache had adopted for decades, which was not to take any shortcuts on quality for the sake of short-term financial gain. To pass the passion for the business on to the next generation, the owner families were already engaging the 5th generation and establishing guidelines, or a charter, on how the next generation could engage while avoiding potential conflicts.⁵

A different path was chosen by **Plaston** where family members were no longer involved in operational management and the board and management were separated.

In 2004, **Plaston** decided to go public and to list its shares on the secondary market. The Frei Family still held over 54% of the shares, with the rest being held by management and a small group of investors. The role of the Board of Directors did not alter much following the death of Hans Frei in 1977. His son Roland then became President of the Board. For the first time, senior, non-family management members joined the Board. Subsequently, the role of management and oversight roles were separated, meaning that Board members were not allowed to hold a management position and vice-versa. In 2013, Roland Frei's son, Jörg, became Chairman of the Plaston Board, thus representing the third generation of the Frei family at the helm of the company.⁶

Board Role in Foundation-Owned Companies

In companies where foundations were part of ownership, the role of the board differed. In the case of **Felchlin**, where the foundation owned the company, management reported periodically to the board. The board function for the company was essentially played by the foundation. At **Jura**, the foundation, established by the

⁵Adapted from Caran d'Ache company profile.

⁶Adapted from Plaston company profile.

founders, owned a substantial stake in the firm next to a few other private owners. These had not changed over many years and appeared to play a more significant role. For **Oetiker Group**, where the board established by founder Oetiker held a noncontrolling stake, some of it placed into a foundation, Thomas Meier-Bickel, CEO and third-generation owner, established a company board that was composed partly of family members and external board members, including the board chair.

Jura was privately owned and did not publish any details on ownership. It was known that Leo Henzirohs and his wife were for a long time the only shareholders in the company. After the fire in 1953, Henzirohs had some of his key staff participated in the share capital. Upon his retirement, the Henzirohs placed the majority of their holdings into a foundation, as they did not have any children. Today, Jura is a closely held corporation with few shareholders, and ownership had not substantially changed over the years. This stability in ownership and governance, combined with Jura's success, had allowed the company to remain financially independent and fund its development from internal resources.⁷

Emergence of Dual Board Structure

The interest of separating ownership from operational management of businesses led several family-dominated companies to introduce a dual board structure. A holding-type board is created to own the key assets of the business, where the influence of the owners is felt most strongly. A second board is created for the main operating business which allows the company to recruit and attract independent board members with relevant expertise in their industry without ownership. Such ownership structures have been observed in the companies **Plaston**, **LNS**, **maxon**, and **Ricola**. We report in more detail below on **Geistlich**, **DC Swiss**, **EAO** and **Felco**.

When the families expand over generations, keeping ownership restricted and respecting everyone's interests becomes a more crucial task. This was particularly important at **Geistlich** where ownership had spread over many family members.

Over its entire history, **Geistlich** remained a private company owned by Geistlich family members and their descendants. The Geistlich shareholding group was comprised of about 40 family members with a shareholder agreement in place. The group met for a general assembly once per year. Since the retirement of Peter Geistlich, no Geistlich family member had been active in operational management. The boards, for the holding company and for Geistlich Pharma, included Geistlich family members with Geistlich, the prime mover of getting the company into the field of bio regeneration, as chairman. The company owners were committed to a strategy of independence.⁸

At **DC Swiss**, one of the smaller researched companies, the business contained several operating companies, all of them reporting to the board directly. The group had a special structure and a group management. The owner families were no longer involved in the operating business.

⁷Adapted from Jura company profile.

⁸Adapted from Geistlich company profile.

DC Swiss was structured along a two-tiered system with Daniel Charpiloz Holding on top owning all the shares of the operating firms. The main company, owned by the holding, was DC Swiss SA, and that company owned the stakes in the German, Italian, UK and Chinese operation directly. The stakes in Safelock SA, the company with the new type of threading systems and Scorta Srl, the Italian company, were held directly by the Charpiloz Holding firm. The entire group of firms operated under the label DC Swiss Group. However, this was not a legally incorporated firm. DC Swiss SA operating management reported to the board that was comprised of members of the Charpiloz family.⁹

At **EAO**, even though the family remained involved in the operating business through the role of CEO, there was a classical split into two boards, which allowed for the recruitment of external board members with relevant industry experience.

At **EAO** the holding company had only Loosli family members as shareholders. On its board were family representatives, as well as Kurt Loosli in the role of Chairman. For the EAO operating business, Loosli recruited a board of external members who each brought special professional skills to the deliberations. Their experience ranged from a CEO in another company, a CFO elsewhere, one with IT and one with HMI automation experience. Again, it was Loosli who chaired this board: *I tell them, that I am not the son of the founder. I am the CEO* (Loosli, CEO).¹⁰

The Flisch family, owners of the **Felco** group of companies, used the dual board structure to recruit not only external board members for the operating companies but also non-family CEOs for the operating businesses. The family nonetheless remained very active and involved strategically in the business through the holding company board.

Throughout its history, **Felco** remained a family-owned company. Ownership was in the hands of Félix Flisch's descendants and their families. Félix and Juliette Flisch had one daughter and one son. Flisch managed the company until 1974, when he turned management over to his son-in-law Eric Perrin, who was CEO until 2002, when his son Laurent Perrin took over for the 3rd generation from 1 January 2003 and remained CEO until 30 June 2011, at which time Christophe Nicolet was appointed CEO, after 66 years the first non-family member to head the firm.

Although the Flisch and Perrin families were no longer involved with operative management of Felco, they remained active in the Flisch Holding company which fully owned Felco, and the separate Prétat SA, supplier of the aluminium handlebars for Felco products, and partially owned FELCO Motion. Through membership on the board in the holding company, the Flisch and Perrin families remained actively involved in the strategy of the group and in Felco in particular.

Felco, as an operating company, had its own dedicated board with at least one member of Flisch Holding and external board members. General management of Felco was in the hands of three members, with Christophe Nicolet CEO since 2011.

Since Felco was a privately held company with a family holding as its main shareholder, no financial data were regularly made public. According to Nicolet, its CEO, there was little talk about EBIT at the firm level. The main financial parameter was the re-investment capacity at Felco for new equipment and projects, which was targeted at about CHF 2 million

⁹Adapted from the DC Swiss company profile.

¹⁰Adapted from EAO company profile.

annually, or about 5 percent of sales. The company did not avail itself of any bank financing or mortgages and was fully financed through the family-owned Flisch Holding.¹¹

Board Structures at Investor-Driven Companies

Some companies remained investor or owner-driven largely because the changes in ownership were relatively recent and the acquiring ownership was still in its first generation of managing the company. Different from multi-generational companies, board structures were focused on current owners who also played active roles in management.

Lantal, majority-owned by Urs Rickenbacher and some partners involved in the management of the company, considered private ownership an advantage because it gave the company a strong impetus and motivated partner colleagues. Rickenbacher had acquired the firm from the 3rd generation of the Baumann family and company founders. Lantal was governed by three bodies: management, partners (shareholders) and the board of directors, which consisted mainly of external members not active in the company. When Urs Baumann, aged 70, no longer wanted to serve on the board of directors, he suggested that Rickenbacher, as the main owner and CEO, should succeed him as Chairman of the Board of Directors. However, Rickenbacher declined, because it violated the basic principles of good corporate governance. As CEO, he preferred to be challenged by external members with extensive experience.¹²

Evolving Role of Boards

This review of the documented firms demonstrates a continuous evolution of the role of the board. In most firms, the board had started out as a reflection of ownership. As long as management and ownership were one, and as long as ownership remained active in management, discussions at the board level were largely statutory. The key conversations took place at work, or at the dinner table, as was the case with some of the early founder husband and wife teams.

As the companies grew, and as new generations took over, there was a sense that ownership and management might have to be separated. With the complexity of the business increasing, board expertise began to be in demand. To avoid intermingling ownership with management expertise, companies started to establish separate boards for ownership of the key company assets, such as real estate. That made room for establishing boards at the operating company level to attract external expertise.

Naturally, those firms that became public companies and whose shares were listed on the stock exchange faced new realities with very specific requirements as to how to structure a board. Once the step into public ownership was taken, the board

¹¹Adapted from Felco company profile.

¹²Adapted from Lantal company profile.

structures were far less subjected to company choice. Regulations of good practice had to be followed. This applied particularly to companies where original ownership by founders had given way to a shareholder pool that was increasingly dominated by free float.

Open Access This chapter is licensed under the terms of the Creative Commons Attribution 4.0 International License (<http://creativecommons.org/licenses/by/4.0/>), which permits use, sharing, adaptation, distribution and reproduction in any medium or format, as long as you give appropriate credit to the original author(s) and the source, provide a link to the Creative Commons license and indicate if changes were made.

The images or other third party material in this chapter are included in the chapter's Creative Commons license, unless indicated otherwise in a credit line to the material. If material is not included in the chapter's Creative Commons license and your intended use is not permitted by statutory regulation or exceeds the permitted use, you will need to obtain permission directly from the copyright holder.



Managing for the Long-Term

For an SME to survive over the long-term, both the adopted management and financial practices need to reflect the long-term vision of the business and its owners. To assure long-term survival as independent businesses, the companies found practices that assured independence beyond the first generation of founders. Some companies went to great lengths to assure that a business could be passed on to another generation of entrepreneurs, sometimes even outside the founding family.

Combining the chapter on management roles with one on how to finance an enterprise highlights the close connection between long-term success and the financial practices selected. Although most companies subscribed to a similar set of goals, the choices were quite different, particularly when it came to the issue of internal versus external financing sources.

- **6 The Role Played by Management**

This chapter spotlights the various forms of the owner—management models adopted by the researched companies, and how they evolved over time as ownership passed on to the next generation.

- **7 Financing the Enterprise**

Examining the many different pathways company founders and successors pursued to finance their businesses, as well as the financial practices adopted to assure longevity of the companies is the focus of Chap. 7.

In both of these chapters, special attention is given to the distinct *SME-type* management style practiced by company leadership and the link towards a tendency to select conservative financial practices as the companies developed.

Table III.1 Management practices

Profile Number	Company Name	Foundation	Role of Management													
			Over-Managed Business	Multi-Generation Owner-Managed	Separating Ownership and Management	Recruiting Successors	Spikes Management Style	Steering Up in Ganges	Utilizing Personal Savings and Equity	Bootstrapping Growth	Using External Investors	Self-Financed Business	Conservative Financial Policies	Preserving Independence	Enjoying M&A for Growth	
1	SEFAR	1833	●	●	●	○	○	○	○	○	○	○	○	○	○	○
2	Burghardt Compression	1844	●	●	●	○	○	○	○	○	○	○	○	○	○	○
3	Geistlich Pharma	1851	●	●	○	○	○	○	○	○	○	○	○	○	○	○
4	Schroder	1879	○	○	○	○	○	○	○	○	○	○	○	○	○	○
5	Candores & Metaux	1885	○	○	○	○	○	○	○	○	○	○	○	○	○	○
6	Lantal Textiles	1888	○	○	○	○	○	○	○	○	○	○	○	○	○	○
7	Max Feichlin	1908	○	○	○	○	○	○	○	○	○	○	○	○	○	○
8	Carren d'Ache	1915	○	○	○	○	○	○	○	○	○	○	○	○	○	○
9	Plumetaz	1923	○	○	○	○	○	○	○	○	○	○	○	○	○	○
10	Kuhn Rikon	1928	○	○	○	○	○	○	○	○	○	○	○	○	○	○
11	Ricola	1930	○	○	○	○	○	○	○	○	○	○	○	○	○	○
12	Jura	1931	○	○	○	○	○	○	○	○	○	○	○	○	○	○
13	Preisa	1934	○	○	○	○	○	○	○	○	○	○	○	○	○	○
14	Filtrox	1938	○	○	○	○	○	○	○	○	○	○	○	○	○	○
15	Plarius	1939	○	○	○	○	○	○	○	○	○	○	○	○	○	○
16	DC Swiss	1940	○	○	○	○	○	○	○	○	○	○	○	○	○	○
17	Rueger	1942	○	○	○	○	○	○	○	○	○	○	○	○	○	○
18	Oetiker	1942	○	○	○	○	○	○	○	○	○	○	○	○	○	○
19	Felco	1945	○	○	○	○	○	○	○	○	○	○	○	○	○	○
20	EAO	1947	○	○	○	○	○	○	○	○	○	○	○	○	○	○
21	Selectron	1956	○	○	○	○	○	○	○	○	○	○	○	○	○	○
22	Pharcon	1956	○	○	○	○	○	○	○	○	○	○	○	○	○	○
23	FSBA	1967	○	○	○	○	○	○	○	○	○	○	○	○	○	○
24	mixon	1961	○	○	○	○	○	○	○	○	○	○	○	○	○	○
25	Sylvac	1969	○	○	○	○	○	○	○	○	○	○	○	○	○	○
26	Bachem	1971	○	○	○	○	○	○	○	○	○	○	○	○	○	○
27	LEMI	1972	○	○	○	○	○	○	○	○	○	○	○	○	○	○
28	LNS	1973	○	○	○	○	○	○	○	○	○	○	○	○	○	○
29	Acuronic	1973	○	○	○	○	○	○	○	○	○	○	○	○	○	○
30	Thermoplan	1974	○	○	○	○	○	○	○	○	○	○	○	○	○	○
31	Komax	1975	○	○	○	○	○	○	○	○	○	○	○	○	○	○
32	Microsp	1981	○	○	○	○	○	○	○	○	○	○	○	○	○	○
33	Diamars	1986	○	○	○	○	○	○	○	○	○	○	○	○	○	○
34	Meditis	1997	○	○	○	○	○	○	○	○	○	○	○	○	○	○
35	U-Box	1997	○	○	○	○	○	○	○	○	○	○	○	○	○	○
36	Wyon	1999	○	○	○	○	○	○	○	○	○	○	○	○	○	○

Source: Table compiled by authors



The Role Played by Management

6

Owner-Manager Versus Professional Manager Models

Looking into the roles played by owners who manage their own companies revealed two patterns. Originally, almost all of the documented firms were owned and managed by a founder, or a group of founders. That meant that during the first generation of owners, management and ownership were largely combined. Over time, however, this pattern evolved, and an increasing number of firms disconnected ownership roles from managing the operational part of the business. Typically, this took the form of engaging an outside CEO, or external management team, not connected to ownership.

Multi-generation Owner-Managed Firms

Sefar, the oldest company of the research project, was unique in that. For many years, the company's management was in the hands of professional managers and only more recently took the step to appoint a representative of ownership for management.

If family members wished to become active in **Sefar**, they were required to have had the appropriate qualifications. In 2018, Christoph Tobler (1957) was the only member of a founding family holding an active top management role in Sefar AG. He had become CEO in 2005, after earning an engineering degree and an MBA, then working for McKinsey and having made a career in the chemical industry. His great-grandfather of the same name had entered the company 150 years earlier. Before Christoph Tobler, Sefar had no family member as CEO, only external managers. The chairman of the board of directors was not member of any of the owner families.¹

¹Adapted from Sefar company profile.

Among the companies still owner-managed in later generations, **Rüeger, Jura, Ricola, and Oetiker** continued to be owner-managed in the third generation. Of those four companies, however, two changed management after the conclusion of the interviews for this publication.

Rüeger remained a family-owned company with the family still holding 100 percent ownership. After the retirement of Rolf Rüeger, son of the founder, the 3rd generation took over in 1991 with Bernard Rüeger, grandson of the founder, nominated as managing director, later CEO and eventually Chairman of the Board. Bernard initially trained as an engineer at EPFL but changed into business studies as he “found engineering boring and I am a businessman.” His younger brother, Jean-Marc Rüeger, joined shortly thereafter following a stint in the IT sector and initially assumed an administrative role, then he became head of manufacturing. In 2012, on the 70th anniversary of the company, Bernard Rüeger turned over the CEO role to his brother Jean-Marc and assumed the role of Chairman while still responsible for business development.²

Without a fourth generation to take over, the Rüeger family decided to sell the company to a corporate owner with whom a longer-term cooperation had already existed.

At **Ricola**, Felix Richterich, representing the third generation of the founding family, had stepped back in 2003 as CEO to concentrate on the role of Chairman. After the unexpected death of the company CEO a few years later, Richterich had to step in again and assume the dual role of Chairman and CEO. In 2019 (after the closure of the data analysis and interview for this project), Felix Richterich stepped down from the CEO role again and a new, external CEO was appointed. One family member was the chief marketing officer (CMO) and thus the only member of the owning family in an operational role. A representative of the fourth generation joined the company board and relinquished an operational role.

At **Oetiker Group**, Thomas Meier-Bickel, representing the third generation of the Oetiker founding family, had been with the company for more than 10 years, 6 years of them as CEO. He had come to the firm with a background in finance and banking, with previous studies in business administration. He admitted that, while he did understand technology, he could not do engineering drawings himself. The fourth generation, according to Meier-Bickel, was still very young!

The experience of these companies, starting as family businesses, demonstrated that the combined owner-management roles were difficult to sustain beyond more than three generations. Since many of the companies in the research were in the B2B space, and in the technical sector on top of that, successive generations often had not pursued a sufficiently technical education, or subsequent careers, to be able to play an operational role.

²Adapted from Rüeger company profile.

First Generation Owner-Managed Firms

How come there is still such a large number of owner-managed firms in the first generation when apparently firms begin to have difficulty recruiting owner-managers beyond the third generation? Of the seven firms that can be categorized as first generation owner-managed, two, namely **Medartis** and **u-blox**, are among the youngest firms in the sample and are still being managed by the founders. In the case of Medartis, company founder Thomas Straumann and co-founder Willi Miesch, in the role of CEO, had been with the firm since its inception in 1997. At u-blox, the three founders, former students at ETH Zurich, remained with the firm in operating roles, although their ownership has been diluted to a small percentage. Since these two firms are less than 25 years old, being still led by the first generation management should not come as a surprise.

Quite different, however, was the experience at six firms included in the research project that “still” run under second generation owner-management despite the fact that they are, in some cases, more than 100 years old. All of these firms experienced recent ownership changes with new owners assuming combined ownership and management roles, essentially setting the clock back to zero.

At **Sécheron Group**, an investor team had assumed ownership in 2005 and filled both the roles of board chairmanship and the CEO, although not by the same person. Similar was the situation at **Burckhardt Compression** where the executive team that led the MBO out of the parent company in 2002, and later launched an IPO in 2006, took on both management and board leadership positions.

As for the three other firms (**Acutronic**, **Lantal**, and **Fraisa**), owner-managed by their founders, who sold their companies to new owners who continued in owner-manager roles.

Acutronic changed hands two times, always with new owners practicing the owner-manager model. Founded in 1973 by entrepreneur Marxer, the company was acquired in 1996 by a new owner, Jung, who continued to manage the company until 2015, when it was sold again to the Aigrin family to be managed by one of their family members.

Second Generation Owner-Managed Firms

Of the owner-managed firms in the 2nd generation, special circumstances usually led to a continuation of the dual roles of ownership and operational leadership. In the case of **Wyon**, this was facilitated since the second generation was part of the start-up operation in the first place. In the case of **Sylvac**, the owning Meyer and Schnyder families were able to have the second and third generations active in management and in the roles of Chairman and CEO. All of the family members, however, had technical backgrounds relevant to the Sylvac business. At **Filtrox** ownership changed and the company was currently owner-managed by the second generation of the Rusch family who had entered into ownership in the 1980s.

The owners of **EAO** faced a particular challenge. Originally started by two entrepreneurs, the business was split after both founders had passed away. The Loosli family assumed ownership of the company, which then had to be transferred to the second generation.

The Loosli family assumed control of **EAO** following a split in ownership after the death of the founders. Widow Dora Loosli and her four children all became shareholders. Two sons entered the business with Kurt Loosli, Jr. eventually becoming CEO. Kurt Loosli brought extensive technical background to his role. After graduating from ETH Zurich, he joined a Swiss firm Ascom dealing with microelectronics and sensors. After earning his MBA at Manchester Business School, he joined ADL Consulting where he stayed three years, becoming head of R&D and deputy CEO of ADL in Switzerland. He joined EAO in 1997. Kurt Loosli's older brother, also in the company, concentrated on the commercial aspect of the firm.³

Challenges of Sticking with Owner-Manager Model

One of the more difficult issues for family-owned and -managed firms to transition to the next generation was finding talent who could effectively play both the owner and the manager roles. If this could not be accomplished, the owners had no other choice but to split ownership and management or, as occurred in some instances, find talent outside the family, or even selling the company outright. Because many founders and owners found divesting their company difficult, the present research documents a number of situations where a great deal of effort and care was expended to keep ownership and management in the family.

Based on the research, it was found that, traditionally, owners were reluctant to appoint daughters to leading management roles in their firms. This was most likely due to the fact that daughters, years ago, were not encouraged to join technology or science-related curricula. Similarly, some 50 years ago it was not a matter of course, or even considered normal, to appoint a daughter to head a family business. Today, these cultural norms have obviously changed.

A first recourse, for some families, was to appoint a son-in-law. Of the five companies, where this was at one time the chosen course, two ended unsuccessfully and were later reversed, and three turned out to be very successful for the companies. This brings to mind a member of a patrician Bernese family, himself a member of the 13th generation, who, when asked how the family could keep much of its assets together, quipped: "Beware of the *pièces rapportées*."⁴

For some family-owned companies, in-laws can represent talent that moves a business forward. At **Kuhn Rikon**, Wolfgang Auwärter who had married the daughter of Henri Kuhn, a son of the company's founder, became CEO and later also Chairman of Kuhn Rikon during a phase of strong growth. At **Felco**, the

³Adapted from EAO company profile.

⁴"Beware of the in-laws."

founder's son-in-law took over management and led the company for 28 years before turning it over to the third generation.

Throughout its history, **Felco** remained a family-owned company. Ownership was in the hands of Félix Flisch's descendants and their families. Félix and Juliette Flisch had one daughter and one son. Flisch managed the company until 1974, when he turned management over to his son-in-law Eric Perrin, who was CEO until 2002, when his son Laurent Perrin took over for the 3rd generation, from 1 January 2003, and remained CEO until 2011, at which time Christophe Nicolet was appointed CEO, who was the first non-family member after 66 years to head the firm.⁵

Separating Ownership and Management

For more than half of the researched companies (21 out of 36), the initially practiced combination of ownership and management had given way to separating the two roles. The rationale for this split was usually based on the fact that from among the owners, suitable successors with the relevant backgrounds did not exist. In addition, there were often experienced professional managers present at the firms who were better qualified and versed in the technologies crucial to the businesses.

At family-owned companies, a split entailed retrenching to running and chairing the board instead. This concentration on the role of the board chair might not have occurred after the first generational ownership turnover, but by about the third generation it was the norm. Such transfers from the third generation onward occurred at **Plaston** and at **Felco**. The experience of **Caran d'Ache** demonstrated the occasionally difficult process of moving from the combined role to splitting responsibilities between owners and management.

With the retirement of Jacques Hübscher, Jr., in 1997 as CEO, the long reign of three generations of Huebschers as CEOs of **Caran d'Ache** came to an end. For the first time, a CEO managed the company without any connection to the three owner families. The transition proved difficult. To find a person who could fit into the family business culture and still assume the role of the CEO was not easy. After the first two years a change became necessary and Silvio Laurenti was appointed CEO in 1999. Achieving considerable success with a challenging strategy, Laurenti remained until his retirement in 2008. A new CEO joined, only to leave again in 2011. To fill in temporarily, Laurenti came back out of retirement until a permanent successor, Jean-François de Saussure, was ready to take on the CEO role. Although without relevant industry background, de Saussure had previously worked at a family-owned company in the region that prepared him for the intricacies of managing a firm with three families as owners. Jacques Hübscher remained a board member until 2012 when his daughter Carole Hübscher, representing the 4th generation, assumed the board chair.⁶

⁵Adapted from Felco company profile.

⁶Adapted from Caran d'Ache company profile.

Plumettaz also experienced the difficulty of changing from family ownership into splitting the roles, as fewer members of ownership were willing to assume operating roles in the company. When this was combined with a transition in ownership to a financial owner, the risks of encountering problems for the business are enhanced.

For almost 80 years, up to 2008, **Plumettaz** had remained a family-owned company with more than 40 shareholders. However, few family members were active in the business. When Gerard Plumettaz retired at age 65 in 2008, a private equity firm took over 70 percent of the share capital. A holding company was created that held all the assets and the PE firm appointed an outsider as CEO. However, the appointment did not work due to cultural differences with a CEO that came from a large company context. Two years later, in 2010, the PE company invited the family back into management. A different PE firm has since acquired the stake and a new external CEO was recruited. Governance rested with a small board of four members. Members were Denis Plumettaz, the newly hired CEO and two PE company representatives. The company's new CEO, Philippe Prate, an engineer by training and education (PhD), had international experience, was a French national and spoke several languages. Both Denis Plumettaz and Philippe Prate were also shareholders in the company.⁷

To avoid the risk of bringing in unsuitable executive talent that can lead to a culture clash, some owners take the route of recruiting from within and often promoting very young managers to senior positions, leapfrogging possible family appointments. The experience at **Fraisa** serves as an example.

At **Fraisa**, as early as 1982, as Hans Stüdeli was approaching retirement at the age of 62, he was beginning to plan for the 3rd generations of Stüdelis to take over. As the father of three daughters, none of them with a technical background or interest in the business, he reached out to his sons-in-law for future leadership of the firm. Two joined management of Fraisa and, together with the production and operations manager, continued to lead the company, with Hans Stüdeli continuing in the board chair.

Taking over management responsibility was a big challenge for both sons-in-law as one of them had a background in law and economics, and the other one in law exclusively. Supported by operational management, this worked well in the 1980s. A business downturn for Fraisa, along with changes in the industry in the early 1990s, and the company entering a period of losses, caused friction among the Stüdeli family. As the company was struggling to catch up in the development of hard metal tools, Hans Stüdeli, at the age of 75, pulled the breaks. He orchestrated a change in management, which resulted in one of his sons-in-law leaving the company in 1995.

Stüdeli, confronted with the risks faced by his company, realized that Fraisa needed professional leadership from outside the family. He approached Josef Maushart, who was just 30 years old and had successfully led the development team for hard metal tools. Stüdeli first offered him the role of head of research and development and to join the management leadership team, but soon he followed up with an enhanced proposal for Maushart to assume the management of the entire company by becoming its CEO. Maushart could pull two other young managers into the leadership team and, together with the senior and experienced

⁷Adapted from Plumettaz company profile.

production and technology head, and support by the remaining family members, assumed management of Fraisa.⁸

The separation of ownership from management roles occurred earlier in the development cycle of larger firms and those who went public. When **Komax** founder Koch turned over his company to management and later moved to MBO and IPO, the company's management was assumed by executives who had been with the company for several years. At **maxon**, a gradual withdrawal of the Braun family, majority owners of the company, to board roles could be observed.

Management of **maxon** was in the hands of professional managers with long experience at the company, in the industry and deep roots in the relevant technology. With the exception of Karl-Werner Braun, the company's main shareholder, ownership did not get involved in operative management other than remaining close to technology. In its more than 50-year history, the company knew only three CEOs who also served as board chairmen for much of their tenure.⁹

The same process took place at **Bachem** where founder and majority owner Grogg turned over operational responsibility of the company to professional management. At **C+M**, long a semi-public firm, management had been in the hands of non-ownership related executive teams. At **LEM**, a public company for decades, management had been traditionally assumed by professional management teams.

In summary, it can be observed that, as a company matures and grows beyond the founding generation, and even moves toward eventual public ownership, professional management teams became the norm along the line. Ownership then concentrates on the board and governance.

The Challenge of Recruiting Successors

The struggle to maintain family ownership for as long as possible sometimes resulted in stories of unusual hiring and recruiting. As the end of family control appeared in sight, owner-managers were challenged to find suitable successors whose views were in line with their own company philosophy. In the case of both **Fraisa** and **Thermoplan**, the owners reached deep inside their own company and appointed young managers who had proven their leadership and managerial skills and yet were not part of the family. In both cases, the owners eventually transferred part, or all, of their ownership stake to the younger managers.

At Fraisa, Hans Stüdeli, second-generation owner, recruited Josef Maushart, a young successful development manager within the company, to take over. Years later, he also was to facilitate the MBO of Fraisa allowing Maushart and his family to become majority owner of the company. At Thermoplan, Domenic Steiner and his

⁸Adapted from Fraisa company profile.

⁹Adapted from maxon company profile.

wife Esther also reached deep inside their own company to look for a replacement and found Adrian Steiner who had been at Thermoplan for just 9 years.

In 2006, Domenic Steiner approached Adrian Steiner (not related) to work with him on a succession plan. Adrian Steiner had joined **Thermoplan** in 1997, just as the introduction of the first automatic coffee machine took place. Adrian Steiner had completed an apprenticeship as electrical installer and attended the Executive Master of Business Administration (EMBA) program of the University of St. Gallen (HSG). Adrian Steiner personally experienced the enormous growth of Thermoplan from 35 to almost 300 employees and was familiar with all facets of the company. In 2008, two years into this process of succession, company founder Domenic Steiner, then 71 years old, decided to step back. In 2009, when Adrian Steiner was appointed CEO, the shareholding structure of Thermoplan was also changed. Adrian Steiner was allowed to take over 20 percent of the shares, with the remainder split between Domenik and Esther Steiner.¹⁰

Sometimes, successors were not found inside a company and had to be recruited externally. The experience at **Lantal** and **Jura** showed how, through the use of headhunters, successors were identified.

Because Urs Baumann's daughters did not want to take over the company, **Lantal** started to look for other succession options. A headhunter was retained, and a solution was found. In 2003, Dr. Urs Rickenbacher joined the company as the new CEO. A graduate from the University of St. Gallen, he was previously head of the German subsidiary of the furniture manufacturer USM. One year after his appointment, in 2004, the majority of the ownership of Lantal was transferred to Urs Rickenbacher and other senior executives in a management buy-out.¹¹

A similar story unfolded at **Jura**, where the group of senior managers who had taken over from company founder Henzirohs, had been intensively looking for a successor since the management team was approaching retirement age:

Oswald Müller, member of the **Jura** management team, and his senior management colleagues, all approaching retirement, were intensively looking for a new CEO to take over. After unsuccessful appointments of external managers, the search company suggested to take a closer look at Emmanuel Probst, already on their board, before he would be hired away by some other company. Probst, with a degree from the University of St. Gallen and marketing experience at Procter & Gamble and Baxter, a medical company, joined Jura in 1991 on a fulltime basis. Later on, Emmanuel Probst was also to become Oswald Müller's son-in-law. Newly in charge, Emmanuel Probst unleashed a process of transformation that was to take about 15 years with a focus on espresso machines.¹²

Possibly the most unusual search for management succession was recalled by Christian Aschwanden who recounted his hiring experience at **Felchlin** where Max Felchlin, Jr., second generation of ownership, was searching for someone to replace

¹⁰Adapted from Thermoplan company profile.

¹¹Adapted from Lantal company profile.

¹²Adapted from Jura Espresso Machines company profile.

him as the CEO of the company. Prior to the search, Max Felchlin, Jr., had assigned ownership of the company to an independent foundation:

At the end of this process of re-structuring ownership, Max **Felchlin**, Jr., still needed to find a replacement for his role as CEO. Since his sons were not considered, the next generation of management had to come from outside the family. In line with his eccentric ways, he orchestrated a recruiting process that the eventual chosen person, Christian Aschwanden, remembers distinctly: *One day in 1991, I was working then with Lindt & Sprüngli, I saw an ad describing the opening of the CEO job at Felchlin. Given my background as a food processing engineer and working for Lindt, I got up my courage and applied. I was invited for an interview, but venue and format were rather unique. All applicants, including myself, and there were many of us, were invited on a boat ride on Lake Lucerne. On the boat were also all senior managers of Felchlin, Max, Jr., included, and we were encouraged to ask questions. After this event, I returned home and did not hear for weeks. Then, suddenly, one evening, I got a call at home (I lived near the town of Schwyz), with Max, Jr., on the line asking me to come on over to his home. That is when I was offered the job (Aschwanden, CEO).*¹³

The experience of finding management, or at times ownership talent, showed how long-serving owners found the courage to pluck very young talent from unusual circumstances and to heave them into positions of responsibility. On all accounts, the likes of Christian Aschwanden at **Felchlin**, Emmanuel Probst at **Jura**, Josef Maushart at **Fraisa** or Urs Rickenbacher at **Lantal** turned out to be company leaders who would exert transformative leadership and bring their companies to new and higher levels, thus assuring the longevity of the firms entrusted to them.

Practicing a Unique Management Style

Reviewing the experience of managers from larger companies, outside the specific SME and family-type company environment, being appointed to a lead position at a demonstrably smaller, medium-sized company and running into difficulties in the process suggested that there was indeed a special way as to how these companies were managed. Core principles unearthed in the research and interviews included flat hierarchies, combined with open communication, allowing lower levels to also be heard by company leadership. As the **Sefar** experience shows, communication was also initiated from the top.

Sefar tried to keep qualified people in the firm by offering an attractive working environment, providing additional monetary benefits and through an express personal appreciation of the employees. For example, the current CEO took time to go out of his way and talk to the people in his employ. He went to the employees at the machines to congratulate them to their birthdays.¹⁴

¹³Adapted from Max Felchlin company profile.

¹⁴Source Sefar company profile.

Robert Lombardini, Chairman of **Sécheron** Groupe, had extensive experience in larger corporate environments prior to assuming his leadership role at Sécheron. Some corporate management principles, such as cost control methods and restructuring, applied to smaller companies as well.

For us at Sécheron, the KMU (SME) management principles are important. We run every division as a separate KMU. KMU management means that everyone speaks to everyone, and everyone is involved in the operations of the company (Lombardini, Chairman).¹⁵

Both **Lantal** and **FISBA** were led by CEOs hired from the outside and they both echoed Lombardini's observations on SME leadership style.

Lantal had an open, personal culture that invited independent thinking and committed work. Everybody was invited to contribute ideas and had some personal space that also tolerated mistakes. Every three months Urs Rickenbacher took the time to spend a day with about ten new employees and to discuss with them where Lantal came from and where they wanted to go. The fact that Lantal was consistently able to deliver high quality products also partly resulted from its qualified and experienced employees. Lantal had a very low fluctuation rate and there were families who worked in the third generation in the company.¹⁶

The culture at **FISBA** was described as diverse, inclusive and collaborative. CEO Markus Hersche observed that the senior management team functioned well at FISBA and that employees consistently exhibited high levels of engagement and worked well together. Due to this culture, FISBA could develop efficient organizational routines with very little "idle power," according to its CEO. The employees were running a corporate bowling and football club. They often organized get togethers, outings and barbecues. Former CEO Werner Krüsi highlighted the open communication at FISBA and its positive influence on the motivation of employees as one of the success factors of the company.¹⁷

The importance of preserving this special SME-type management style was also deemed crucial to the company's success when it reached a larger size and the close bond between employees and management was at risk. The experience of **Burckhardt Compression**, with more than 2000 employees worldwide, was highly relevant in this context.

Valentin Vogt, Chairman and CEO of **Burckhardt Compression**, was a strong believer in smaller, manageable units. When he took over management of Sulzer-Burckhardt he recalled that, . . . *there were about 400 people working at the Oberwinterthur location and I knew everyone by name. When organizational units pass 1500 staff, they become slow and lazy, and one starts to hire people who keep others from being productive* (Vogt, Chairman and CEO).

Vogt became intrigued by an independent church in the Winterthur area where church leadership kept the congregations at about 1000 and when they grew beyond that, simply created another congregation to start all over again. With more than 1000 church members things became too anonymous. Applying the "Beehive Principle" the church moved to another location in the region creating a new congregation.

¹⁵Adapted from Sécheron Groupe company profile.

¹⁶Adapted from Lantal company profile.

¹⁷Adapted from FISBA company profile.

With Burckhardt surpassing 2000 headcount, Vogt was eager to create his own “bee-hive” experience. The company divided its operations into two distinct parts, one for new machine systems and one for service business, both operated under different key success factors. Vogt likened this organizational move to operating two frigates instead of a single aircraft carrier. Each unit had its own management team, was endowed with autonomy and led by a small holding group on top with only 11 executives and staff. *Synergies rarely exist, and they are consistently overvalued by managers* (Vogt).¹⁸

If there was a *Swiss style* of management for medium-sized firms, it was described as down-to-earth, approachable, informal and with a familiar type of communication across multiple levels, while at the same time being guided by a vision of where the respective industry sector was headed. Some interview partners maintained that there was a clear difference from the Anglo-Saxon style of management.

This *everyone-talks-to-everyone* style of management appears to be a key ingredient to the success of the firms researched. While size plays a role, it also requires a style of personal interaction and trust that makes this possible. Mutual respect is crucial to this dialog. A management that respects the skills of its employees, and self-confident employees who are aware of the value of their capabilities, are both important ingredients in this exchange.

This difference and uniqueness of the Swiss SME-type management style was most sharply articulated by company leaders who had joined their SME from the outside, usually having worked at a larger company. This suggested to the authors that those CEOs were more acutely aware of the differences in management style between the typical corporate industry environments in comparison to what they experienced when joining an SME. By contrast, leaders who had always been part of the SME environment probably considered this style too obvious and commonplace to comment upon.

Open Access This chapter is licensed under the terms of the Creative Commons Attribution 4.0 International License (<http://creativecommons.org/licenses/by/4.0/>), which permits use, sharing, adaptation, distribution and reproduction in any medium or format, as long as you give appropriate credit to the original author(s) and the source, provide a link to the Creative Commons license and indicate if changes were made.

The images or other third party material in this chapter are included in the chapter’s Creative Commons license, unless indicated otherwise in a credit line to the material. If material is not included in the chapter’s Creative Commons license and your intended use is not permitted by statutory regulation or exceeds the permitted use, you will need to obtain permission directly from the copyright holder.



¹⁸Adapted from Burckhardt Compression company profile.



Frugal Beginnings Predominate

Founders of the researched companies, as well as their successors, availed themselves of a number of sources and instruments to fund their growing businesses. They invested their own savings, borrowed from friends and families, accessed bank financing, took out mortgages and, occasionally, connected with outside investors. By and large, they were frugal and, more often than not, boot-strapped their ventures to avoid dependence on external financial sources such as banks.

Visiting these companies and their production operations today hides the fact that many of them had started on very simple premises. Some began their companies in garages, on the kitchen table, in simple rented facilities or they acquired old factories from companies that had either gone bankrupt or closed down completely. Thriving enterprises today and, on average, employing hundreds of people, it is difficult at times to imagine that such was not always the case. Generally, behind every one of the researched companies, there was a humble beginning.

Starting Up in Garages and Old Factory Buildings

Several companies started in the proverbial garage, in simple surroundings and with small teams of two or three employees. In addition, the founders had given up their previous jobs or were working two jobs to make ends meet.

- Emil Richterich started to make his candy, later to be branded **Ricola**, in his bakery in 1930 in the town of Laufen.
- Hans Frei started **Plaston** in 1956 in the garage of his parents.
- Max Koch started **Komax** in 1975 in a shed near Lucerne.
- Paul Wyser started **Wyon** in 1999 in the garage of his own house in the town of Steinegg, Appenzell, located at an altitude of 1100 m.

Needless to say, these firms have long outlived their “garages” and have since expanded into modern facilities for both production and administration, as well as having scaled up operations.

Some of the companies followed in this study were one step ahead of the “garage entrepreneurs” in taking advantage of unused factory buildings laying idle due to economic downturns. In the Western part of Switzerland, companies active in the watch industry had fallen on hard times during the economic depression in the 1930s. In the Eastern part of Switzerland, many textile operations lay idle due to the long-term decline of the textile industry.

- Hans Stüdeli started **Fraisa** in 1934 by buying out a tool making operation, which had gone bankrupt.
- Hans Oetiker started **Oetiker** in 1942 by acquiring an old, unused factory in the town of Horgen.
- Hans Schmid started **Filtrox** in 1938 by acquiring an old, idle textile factory in St. Gallen.
- Heinrich Kuhn acquired a workshop in **Rikon** in 1926 that had been making old-fashioned copper pans.
- Felix Flisch acquired a former workshop for watch components in 1945, located in Les Geneveys-sur-Coffrane, where he established **Felco**.
- Peter Grogg started **Bachem** in 1977 in rented quarters in Liestal and, after moving to Bubendorf where he was still renting, acquired a factory complex, which became available after a bankruptcy.

Snatching up idle factory sites allowed these companies to scale up on minimal investments in a country where real estate has traditionally come at a premium and where building permits for new operations on land were not always easy to get. Recycling these operations and re-purposing them for new use meant that industrial activities were not lost on the host communities.

Tapping into Personal and Family Savings

Since company founders were often from backgrounds of limited financial means, the question was how to finance their start-up operations. Few could bring substantial amounts of capital into their companies and, for the older companies in the sample, there was no easy access to financial markets or instruments as are available today.

- Heinrich Kuhn got help from his in-laws to acquire the factory building in **Rikon**.
- Hans Frei invested his retirement pension of CHF 25,000 to buy the first equipment for **Plaston**.
- Peter Grogg invested CHF 50,000, together with his wife and partner, to start **Bachem** from funds he had saved up from his previous stint in the USA.

- Domenic Steiner funded **Thermoplan** together with his wife from their own resources.
- Paul Wyser started **Wyon** with his own resources in addition to getting help from a friend and a business partner, without any conditions attached.

The amounts invested by the company founders were relatively small, but when combined with either “garage-type” premises, or the acquisitions of unused factory buildings at low prices, the resources were sufficient to start up.

Bootstrapping Mentality

Once up and running, the early founders had to operate frugally and make use of limited resources. Peter Grogg, when starting **Bachem** in 1971, was crafty with his use of second-hand equipment and installations.

Bachem focused initially on peptide synthesis. To start his business, and to save on needed capital, Grogg made savings in a number of areas. For his lab equipment he used elements of a simple, standard home kitchen and his friends at his former employer Ciba let him buy a used car for a small amount, filled with empty vials that had been discarded.¹

These two additional examples are also instructive.

Hans Frei, **Plaston** founder, demonstrated how as a start-up founder he leveraged scarce time and limited resources to acquire his first customers.

Hans Frei founded **Plaston**, aged 55, in 1956 in his parent’s garage. Poor health forced him to leave his job at the textile manufacturer Viscose. He invested all his savings to buy a 60-ton injection-molding machine and began to produce plastic products for the household market. Criss-crossing Eastern Switzerland by train, he travelled from town to town to meet with buyers from major household resellers. Serving as a sergeant in the army, he soon discovered that several of his fellow soldiers were business owners. It was through this network that he secured early orders and managed to establish a reputation for quality.²

Paul Wyser, **Wyon** founder, leveraged his time, his limited resources, and the low-cost region of the Appenzell to save on production resources.

In the first five years **Wyon** was located in the garage of Paul Wyser’s house above Appenzell, at an altitude of 1,100 meters. It had always been important for the founder to remain independent; they did not want any money from outside investors. One friend and one business partner invested some money but with no conditions. Paul Wyser was able to continue working as an external consultant for the Swatch Group, which provided the main income for the entire development work during the first few years.

Utilizing the whole network Paul Wyser had built up during his career, he and his sons had the opportunity to use various devices at institutes and companies throughout

¹Adapted from Bachem company profile.

²Adapted from Plaston company profile.

Switzerland; this, however, was very cumbersome. For example, to produce a battery in the early days of the company, Philipp Wyser started work in his garage as far as his limited machinery would go. Then, to be able to weld ultrasonically, he had to go to a company in Bronschhofen. He then had to drive to Basel, to the university, where he could use a glovebox. Then he went to Zurich, to Phonak, to charge the batteries. Overall, it took about two weeks until a new battery specimen was ready. However, before investing further money in their own equipment, he wanted to be sure that the planned product would really work, at least in principle.³

Even in later years, founders preferred to rely on their own resources when faced with major investments. Domenic Steiner at **Thermoplan** is a case in point.

In 1995, at Domenic Steiner's usual rounds at restaurant fairs, or visiting customers and users of **Thermoplan** cream whipping and hot milk foaming machines, some suggested that only coffee was missing from the mix. The development of an automatic coffee machine for use in restaurants and hotels, however, was to require a considerable investment. Domenic Steiner, who ran a profitable business with 21 employees, decided nevertheless to take this next step. Recruiting a suitable engineering team, the company worked on the project for two years and the founder invested CHF 2 mio from his own resources into the project, partially tapping into his pension fund, to avoid having to approach external investors.⁴

And finally, **Medartis** offers still a different example. Although owner financed through founder Thomas Straumann, the resources he could commit to the ramp-up of Medartis, until it was brought to the public through an IPO, were a substantial improvement. The Straumann funding had allowed the company to grow quickly and possibly faster than if it had to do with the resources of a less financially endowed founder.

When **Medartis** was formed in 1997, the fledging operation was essentially 'non-bankable.' Thomas Straumann, in his role as sole owner and founder, also assumed the role of investor and, until the company reached profitability, loaned an amount in excess of CHF 100 mio to cover accumulated development costs and losses. *Without Thomas Straumann, there would be no Medartis today!* (Miesch, CEO).

Having turned the corner and reaching profitability, Medartis undertook an IPO on the Swiss stock market in 2018 that brought in fresh capital for future expansions, allowed the repayment of private loans and brought in some CHF 120 mio in additional liquidity that could be used for eventual expansions or merger and acquisition (M&A) activities. All of the IPO proceeds flowed into the company and existing shareholders did not sell any of their shares. The announced goal was to reinvest any profits back into the business. The company was now essentially debt free.⁵

³Adapted from Wyon company profile.

⁴Adapted from Thermoplan company profile.

⁵Adapted from Medartis company profile.

Leveraging External Investor Resources

As illustrated by the Medartis example, start-ups were usually not “bankable.” It was probably a function of more recent developments that investor financed companies appeared towards the latter end of the research window. One of the youngest firms to join the sample of 36 companies fit this investor-funded model precisely.

When three students and their professor founded **u-blox**, financing came initially from a group of friends and family members. Soon, however, the private equity firm Partners Group (Zug) joined as a major investor. The investment was made as a result of the founders circulating an aggressive business plan sent out in 1998 to entice investors. Following initial orders, the company was also able to attract the UK investment company 3i to join.⁶

None of the other founders and owners of the 36 companies researched had to or would have been willing to, forfeit a substantial part of their equity to bring in external investors. They preferred to go slowly and stay within their own means. On the other hand, the development task of bringing **u-blox** products to market, and the need to occupy a segment of the world market quickly, would have exhausted most of the founders’ personal resources. In the end, the u-blox founders ended up with only about 5% of the company’s equity. Some might argue that 5% of a large pie is better than owning 100% of a small pie.

Sometimes, additional resources were tapped through allowing new investors to join when a company was in need of fresh capital. This was the route chosen at **Caran d’Ache** when its then majority shareholder Schweitzer invited the Hübscher family to join as a shareholder in 1930.

To achieve the ambitious goals of retrofitting the **Caran d’Ache** factory to launch new products, and to develop export markets required an investment of more than CHF 5 million, an amount beyond the means of Schweitzer and his partners. With the help of, and through the connections of Joseph Reiser, financial advisor and accountant, Jacques Hübscher, Sr., a Swiss merchant and raw material trader living in Marseille, provided the needed funds for continuing the development of the company. Intended as a loan to be repaid within five years’ time, Schweitzer did not have the funds to pay off the loan. Hübscher remained invested in the firm, later became a shareholder and eventually joined its board of directors. When Schweitzer sold his shares in 1946, the Hübscher, Reiser and Christin families became co-owners of the company. Henri Hübscher (1894–1959), Jacques’ son, assumed a controlling interest in 1947 for the Hübscher family.⁷

⁶Adapted from u-blox company profile.

⁷Adapted from Caran d’Ache company profile.

Utilizing Leveraged Financing

When the sale of a company was considered, leveraged financing became necessary, since the amounts in question were, typically, beyond the means of the new owner-managers. Leverage could be obtained through a bank lending facility, an investment fund, or through private equity.

When the employees of **Selectron** decided to buy out their corporate owner, the employees had only a small amount to invest directly. Additional equity financing was provided by outside investors and a large part was injected by regular bank lending.

Banks, after first balking at the idea of a leveraged employee buyout of **Selectron**, agreed to finance about 60 percent of the acquisition price. For the 40 percent equity required, 75 percent was contributed by a group of international investors recruited and the remaining 25 percent by employees. Eighty percent of them voluntarily decided to participate, some 46 staff members invested collectively CHF 1.25 mio in their company.⁸

The investor team that acquired **Sécheron** from its financial owner, a local bank, had to inject equity, but also profited from a substantial loan made by the selling bank to leverage their equity portion.

A group of six private Swiss investors came together and were able to acquire **Sécheron** from the bank. The partners did not see themselves as a private equity group in the traditional sense, but instead were actively involved in the business and had no plans to sell. By investing their own money, the new owners all had ‘skin in the game.’ The acquisition was heavily leveraged with financing provided through two banks requiring only a minimum of investor capital.⁹

Financing Current Business

For the financing of current business, and in particular, when larger investments were needed, companies often turned to bank lenders for funding. The experience of SMEs with bank lending was mixed, at best. **Datamars** relied on such funding, in conjunction with private equity:

All acquisitions of **Datamars** would not have been possible without the backing of its principal bank and, especially, its private equity investor Columna Capital. Together with management, this PE investor developed the Datamars’ growth strategy and also supported it financially. In 2017, Datamars further strengthened its investor base when Caisse de Dépôt et Placement du Québec, a large, long-term institutional investor from Canada, became the company’s largest shareholder, investing alongside Datamars’ senior management and Columna Capital, which had been involved financially with the company since 2011.¹⁰

⁸Adapted from Selectron company profile.

⁹Adapted from Sécheron company profile.

¹⁰Adapted from Datamars company profile.

Smaller firms, who at times need to rely on banks for the funding of current business, have reported a number of negative experiences that resulted in avoidance, if possible, of such lending.

In 1988, **Kuhn Rikon** agreed to acquire 60 percent of the shares of Spring, a company based in Canton Thurgau specializing in the cooking-at-table segment, with a strong retail presence and business to catering companies. Financing the transaction was also made difficult when the banks, initially willing to separate the buildings from the business transactions, granted 100 percent mortgages on the buildings, only to change their minds later, suddenly requesting a reduction of the mortgages to 60 percent of building value. Kuhn Rikon was also in the midst of installing a major new production system representing a large investment. The issue was resolved with the help of external friends. This led company management to 'No more banks' when it came to major financing.¹¹

As a small company, **Rüeger** relied partially on bank financing. It maintained relations with the two large Swiss nationwide banks, as well as with a regional bank. **Sylvac**, another small company was also relying on bank lending.

Although sales for **Sylvac** progressed steadily to almost CHF 30 mio, the company did experience several serious downturns caused by external economic circumstances. In all of these situations, the financing through its banks became an issue. The first downturn occurred in 1990 when sales to its US distributors suddenly dried up because of banks making unilateral changes in financing customer terms without informing Sylvac beforehand. More significant was the impact of a downturn of about 1/3 in sales in 2002 when the main lender for Sylvac suddenly decided to get out of loans to measurement companies, including Sylvac. Fortunately, a regional bank stepped in to help out when Sylvac loans suddenly became due.¹²

The experience of smaller companies with bank lending for ongoing operations was often negative and became part of a strategy to steer as clear as possible from such lending.

Relying on Cash Flow and Internal Sources

Given the strong preference for independence expressed by many of the firms, it should come as no surprise that a fair number of them strove for financial independence from external investors, or from banks. To gain, and guard such independence, a strong financial performance was required and a parallel agreement among owners to reinvest a good portion of profits back into the business. This self-restriction required discipline, both on the part of company management and ownership. **Felco** had a self-imposed restraint as its guidelines.

¹¹Adapted from Kuhn Rikon company profile.

¹²Adapted from Sylvac company profile.

Since **Felco** was a privately held company with a family holding as its main shareholder, no financial data were regularly made public. According to its CEO, there was little talk about EBIT at the firm level. The main financial parameter was the re-investment capacity at Felco for new equipment and projects, which was targeted at about CHF 2 mio annually, or about 5 percent of sales. The company did not avail itself of any bank financing or mortgages and was fully financed by the family-owned Flisch Holding.¹³

Even for companies with strong earnings, complete reliance on internal funding was not always possible. **EAO** used a differentiated approach to mix internal funding with occasionally accessing external lending.

When the two company founders passed away, **EAO** was debt free since the company had traditionally relied on self-financing. After the asset split into two companies, EAO and its HMI business had to live through more difficult times due to the fact that the bulk of the company liquidity had been spun-off. Regardless, EAO relied on external financing for current or short-term needs only. When building up the automotive segment, which required a considerable investment, EAO used loans for the three-year development and ramp-up period.¹⁴

By contrast, **Jura** was in a very strong position to achieve this financial independence because of its size and profitability.

Jura was a closely held corporation with few shareholders and ownership had not substantially changed over time. This stability in ownership and governance, combined with Jura's success, had allowed the company to remain financially independent and fund its development from internal resources. According to one insider, the company was using banks for its treasury and transaction operations, not for lending or credit purposes.¹⁵

Among larger companies covered by the current research, those with sales in excess of CHF 200 million, there was also a strong reliance on funding growth and business needs internally. Typical for those companies are the statements below.¹⁶

- **Sécheron** was financing its growth and investments from internal cash flow. As a result, the company did not see a need for going public. Sufficient resources were present to fund internal development and a group of about 100 engineers in Geneva, and elsewhere, were developing and improving its product line.
- **LEM** had a long experience with being a listed company, dating back to 1986. With its listing on the Swiss exchange, LEM had access to capital if needed. With a steady cash flow of more than 10% of sales, the company was in a position to finance its own capital needs internally from own resources. The relatively healthy profitability allowed for a targeted dividend payout ratio of in excess of 50%, appreciated by its shareholders.

¹³Adapted from Felco company profile.

¹⁴Adapted from EAO company profile.

¹⁵Adapted from Jura company profile.

¹⁶Adapted from the relevant company profiles of Sécheron, LEM, Burckhardt and Komax.

- **Burckhardt Compression** management believed that operating as a public company listed on the Swiss stock exchange offered some important advantages. Although the CHF 30–40 mio of free cash flow allowed the company to finance its investments internally, including the India and China acquisitions, there were always situations where access to the stock market would allow raising capital beyond its own cash flow generation. Burckhardt Compression's stable profitability and cash flow allowed for a dividend payout ratio of 50% or more.
- Through its stock market listing, **Komax** had access to additional capital if needed. Over its history, the company could rely largely on its self-generated cash flow and used external debt financing through banks for only a small part of its capital needs. Its financial performance, measured in RONCE, of 25% and with an EBIT of CHF 50 million or more, allowed for a constant investment of about CHF 20–25 million and a targeted dividend payout ratio of 50–60% of earnings after tax.¹⁷

Adopting Conservative Financial Policies

In general, the researched companies followed conservative financial policies. At times, this was officially stated and considered an advantage over publicly owned companies, which were subject to different accounting policies or pressures on earnings. **Maxon**, one of the largest companies in our sample and privately owned, was fully internally financed. Below are the views of three privately held companies concerning their financial policies.¹⁸

- Despite being a family business, **Sefar** behaved like a public company and, for example, applied accounting principles according to Swiss GAAP FER. Sefar was financed conservatively and had zero net debt in 2018. According to Christoph Tobler, this allowed for a high degree of independence, freedom and flexibility. For example, this made it possible to buy the company Monosuisse during the financial crisis.
- For almost 40 years since the company was founded, Domenic Steiner and his wife Esther were the only shareholders of the **Thermoplan**. They followed conservative business practices, funding all expansion on their own without any recourse to external financing. Being a family company, they met often and discussed and resolved issues together.
- For strategic control of **Oetiker Group**, CEO Meier-Bickel focused on sales growth as the key metric, which was targeted as exceeding market growth. Profitability ensured financial independence and was target at above 10% EBIT for its core business segments. Given present sales levels, this allowed for an

¹⁷RONCE stands for Return on Net Capital Employed and EBIT for Earnings before Interest and Taxes.

¹⁸Adapted from the relevant company profiles of Sefar, Thermoplan and Oetiker Group.

internally generated investment budget of about CHF 20 million annually. The company maintained reserves for acquisitions and sometimes availed itself of bridge financing. The ability to approach an acquisition target without having to take on credit for the deal added to the credibility as an acquirer. Oetiker operated under a long-term strategic plan for the period until 2030. Quarterly figures were not relevant in this context.

Fraisa offered a detailed example of how privately owned companies need to adapt their financial policies to the evolving needs of the economic realities.

Lessons from the financial crisis made **Fraisa** change its financial policies. Zero outside debt, financial strength and dependability became top priorities. Debt would be used for mortgages only with up to 50 percent of building value. Profitability had to ensure that the company could make CHF 8 to 10 mio of investments annually, for which the company needed both product and volume growth.

Detailed results for 2018–2019 were published as customary for Fraisa. Sales reached CHF 110 mio, with an EBITA of CHF 27 mio. This allowed the company to spend CHF 6.6 mio on R&D, invest CHF 9.5 mio in fixed assets and machinery and grow its global workforce to 547. External financing amounted for just 7 percent of total assets and the capital ratio reached 62 percent of total assets.

A crisis makes you think about things that appear to be non-touchable. For an owner-managed firm, you need to respect some limits, which are 3 to 4 percent of annual growth and not much more (Maushart, CEO).¹⁹

Lantal, a company subject to considerable volatility in its sector for specialty textiles, adopted a strategy to smooth this volatility through operational, rather than financial means.

In 2017, the aviation industry accounted for about two thirds of **Lantal**'s turnover, 30 percent was ground traffic and the rest was the premium segment, i.e. VIP or yacht interiors. Worldwide, Lantal had a market share of 65 percent in aircraft seat covers. Concerning the aviation industry, 90 percent or more was customer specific. Thus, Lantal made very few standard products and tried to individualize as much as possible. The aviation industry was a very volatile industry, with 95 percent of turnover coming from project business. If a project was postponed for whatever reason, there was less turnover. As a result, Lantal often had deviations from the plan of +/- 35 percent per month.

To compensate for this without having to lay people off, Lantal developed a model in which people were trained intensively and multifunctionally and could work in all three production sites in Switzerland. Yet, crises in the aviation industries have also led to some downsizing in the past. As a result of the 9/11 terrorist attacks in the US, several airlines cancelled their orders and Lantal's turnover decreased from CHF 121 mio in 2000 to CHF 89 mio in 2003. Some years later and after partly recovering, Lantal's turnover again dropped by 24 percent to CHF 86 mio, following the global financial crisis. Again, Lantal was able to recover and achieved sales of more than CHF 100 mio in 2014.

Although privately held companies pursued conservative financial policies, there was nevertheless a sense among the public companies that this independence could

¹⁹Adapted from Fraisa company profile.

at times lead to complacency and delayed action when changes were needed. The CEO of **Burckhardt Compression**, Valentin Vogt, expressed this observation during the interview as follows.

As a public company subject to larger scrutiny, dealing with changes in the economy also required a different response time. During the financial crises of 2008–2009 when orders for major equipment sharply declined, as a public company management felt forced to react right away by reducing costs. *A private company might have been able to ride out the storm and wait for the economy to come back* (Vogt, Chairman and CEO).²⁰

The experience of companies researched shows that conservative financial strategies were the norm, particularly for those companies that had existed for a longer period of time. For companies founded more recently, for example after 1970, the changing attitude of financial markets and the more commonly available risk capital has become visible. To maintain independence, older companies and their owners were willing to impose on themselves considerable self-restraint in terms of profit payout, to the point of foregoing considerable cash dividends to continue to grow the company.

While tapping into financial markets is now more typical, the companies who did so were pursuing approaches that allowed for a level of operational independence while at the same time ensuring stability among investors. Once achieved, following their opening to outside investors, these companies again preferred to finance themselves internally as much as possible, a return to their earlier policies, it seems.

Open Access This chapter is licensed under the terms of the Creative Commons Attribution 4.0 International License (<http://creativecommons.org/licenses/by/4.0/>), which permits use, sharing, adaptation, distribution and reproduction in any medium or format, as long as you give appropriate credit to the original author(s) and the source, provide a link to the Creative Commons license and indicate if changes were made.

The images or other third party material in this chapter are included in the chapter's Creative Commons license, unless indicated otherwise in a credit line to the material. If material is not included in the chapter's Creative Commons license and your intended use is not permitted by statutory regulation or exceeds the permitted use, you will need to obtain permission directly from the copyright holder.



²⁰Adapted from Burckhardt Compression company profile.

Part IV

Focus Choices

Finding and adopting the right kind of focus is central to an SME's competitiveness against much larger firms. By devoting three entire chapters to this issue, the authors want to signal the importance this topic has for the long-term success of the researched firms, while at the same time giving the discussion enough depth to stimulate other companies to think through their own focus strategies. Thus, the entire section is focused on *Focus*.

- **8 Business Focus Choices**

This chapter highlights the fact that *Focus* is not just *Focus*, inasmuch as there are different forms of focus from which to choose. Beyond explaining and categorizing the different types of focus, details are offered about how companies selected one form or another, and the implications of one focus choice versus the other.

- **9 Franchise Focus Choices**

The concept of the customer franchise—defined as a distinct group of users for whom the company offers a central element or product—constitutes the bulk of this chapter. Explanations are offered about how companies attach such groups to their products, as well as how they create loyalty.

- **10 The Process of Focusing**

Describing a company's achieved focus is one thing but finding out how these companies arrived at their given focus, through an analysis of the focus journey, is an important aspect of understanding the practices adopted by the researched SMEs. The chapter ends with the introduction of the *multiple layers of focus* concept and offers lessons from the focus journeys of the researched companies.

Table IV.1 Focus choices

Profile Number	Company Name	Foundation	Business Focus Choices				Franchise Focus Choices				Focus Processes				
			Focus on Single Industry	Focus on Single Business	Focus on Technology	Single Customer Franchise Focused	Franchise around Single Industry Focused	Franchise around Institutions	Professional Group Focused	Solution Focused	Consumer Franchise Focused	Deliverable Franchise Journey	Multiple Layers of Focus		
1	SEFAR	1833	○	○	○	○	○	○	○	○	○	○	○	○	○
2	Burckhardt Compression	1844	○	○	○	○	○	○	○	○	○	○	○	○	○
3	Geistlich Pharma	1851	○	○	○	○	○	○	○	○	○	○	○	○	○
4	Secheron	1879	○	○	○	○	○	○	○	○	○	○	○	○	○
5	Cendres & Métaux	1885	○	○	○	○	○	○	○	○	○	○	○	○	○
6	Lantal Textiles	1886	○	○	○	○	○	○	○	○	○	○	○	○	○
7	Max Felchlin	1908	○	○	○	○	○	○	○	○	○	○	○	○	○
8	Caran d'Ache	1915	○	○	○	○	○	○	○	○	○	○	○	○	○
9	Plumetiz	1923	○	○	○	○	○	○	○	○	○	○	○	○	○
10	Kuhn Rikon	1926	○	○	○	○	○	○	○	○	○	○	○	○	○
11	Ricola	1930	○	○	○	○	○	○	○	○	○	○	○	○	○
12	Jura	1931	○	○	○	○	○	○	○	○	○	○	○	○	○
13	Fralisa	1934	○	○	○	○	○	○	○	○	○	○	○	○	○
14	Filtrox	1938	○	○	○	○	○	○	○	○	○	○	○	○	○
15	Philatus	1939	○	○	○	○	○	○	○	○	○	○	○	○	○
16	DC Swiss	1940	○	○	○	○	○	○	○	○	○	○	○	○	○
17	Ruegger	1942	○	○	○	○	○	○	○	○	○	○	○	○	○
18	Oetiker	1942	○	○	○	○	○	○	○	○	○	○	○	○	○
19	Falco	1945	○	○	○	○	○	○	○	○	○	○	○	○	○
20	EAO	1947	○	○	○	○	○	○	○	○	○	○	○	○	○
21	Selctron	1956	○	○	○	○	○	○	○	○	○	○	○	○	○
22	Plaston	1956	○	○	○	○	○	○	○	○	○	○	○	○	○
23	FSBA	1957	○	○	○	○	○	○	○	○	○	○	○	○	○
24	mason	1961	○	○	○	○	○	○	○	○	○	○	○	○	○
25	Sylvac	1969	○	○	○	○	○	○	○	○	○	○	○	○	○
26	Bachem	1971	○	○	○	○	○	○	○	○	○	○	○	○	○
27	LEM	1972	○	○	○	○	○	○	○	○	○	○	○	○	○
28	LNS	1973	○	○	○	○	○	○	○	○	○	○	○	○	○
29	Acutronic	1973	○	○	○	○	○	○	○	○	○	○	○	○	○
30	Thermoplan	1974	○	○	○	○	○	○	○	○	○	○	○	○	○
31	Komax	1975	○	○	○	○	○	○	○	○	○	○	○	○	○
32	Mikrop	1981	○	○	○	○	○	○	○	○	○	○	○	○	○
33	Dalimar	1988	○	○	○	○	○	○	○	○	○	○	○	○	○
34	Medaris	1997	○	○	○	○	○	○	○	○	○	○	○	○	○
35	UEblox	1997	○	○	○	○	○	○	○	○	○	○	○	○	○
36	Wyon	1999	○	○	○	○	○	○	○	○	○	○	○	○	○

Source: Table compiled by authors

Focus Comes in Different Forms

All of the SMEs included in this project adopted some form of a focus strategy. There were, however, a number of different ways of focusing. For the purpose of this research, categorizing those different ways was of great importance. Equally important to the authors was the provision of sufficient background regarding the ways in which companies arrived at their focus, and how it was then implemented. Just to state that SMEs were *focused in some way* was simply not sufficient to learn about this practice in depth.

The emphasis in this chapter is on the five major ways of focusing and organizing those strategies from less to more restrictive in terms of business strategy. While categorizing the different focus types, and matching companies with those categories, it became clear that some of these firms might be attributed to more than one single type of focus. For clarity, each firm was linked to one focus type only, recognizing that other observers might connect these companies and their focuses differently.

- Industry Focus
- Business Focus
- Competency Focus
- Technology Focus
- Market Focus

Focusing on a Single Industry

For most companies, the initial entry into some industrial activity provided the beginning of their focus, at least in terms of industry or product line. Many of the older companies in the sample began in a given industry sector and remained loyal to that sector for decades. This is called *industry focus* in the study and considered the

least limiting or restrictive kind of focus, since it allowed management to embark on multiple businesses, leveraging different competencies or technologies, as well as target different markets. For some companies, industry focus seemed to be more of a statement of mission or purpose. The following are examples from the research.

- **Sécheron** started in Geneva, in 1879, with the production of some electric equipment and appliances, moving into electrical motors and generators. The nature of the industry and company did not really change over decades, although the applications and customer groups did.
- **Burckhardt Compression** started as a machine builder in 1844 and by 1883 had moved to building compressors, the business sector that remains its focus today.
- **Ricola** was started in 1930 as an extension of Emil Richterich's bakery business and was always focused on herbal sugar candy.
- **LEM** started on founder Jean-Pierre Etter's kitchen table in 1972; he made devices and components that measured and sensed electrical parameters, a business that the company has stayed with.

Many of the companies cited began with focusing long before the term had entered business strategy discussions. None of these firms decided from the outset that they would focus on a given activity. They produced a product that found loyal customers and eventually stayed with that business. By continuously responding to customer orders, the focus came slowly, as the result of filling repetitive orders from a similar customer group. However, these companies often went on to eventually define their focus around many additional dimensions, as will be explained later.

Some of the younger companies, launched from the 1970s to 2000, came into being by formally declaring their mission or purpose. Those statements could be interpreted as a declared industry focus at the inception of the companies' journey forward. Industry focus, while being the first set of restrictions companies imposed on themselves, did not signify a narrowly targeted focus. Industry focus still left room for many later decisions, from customers, technology, and application to value chain and even material dimensions. It will emerge later in the analysis that some companies repeatedly sharpen their focus strategies, suggesting that by taking an industry focus approach alone, they did not consider themselves sufficiently focused.

The main interest here, therefore, is not on focus by chance but instead on those practices that resulted in a deliberate managerial process to achieve a clear focus. Only if expressly stated—intentional processes of focus are identifiable—can such approaches be instructive and offer a meaningful and value-added view for other companies, executives, and entrepreneurs.

Experience Leading to Business Focus

Pursuing an industrial activity over time and accumulating extensive experience was a possible way in forging a focus. Several companies, **Sefar**, **Plumettaz**, and **Jura** among them, started without an articulated focus strategy. They developed their

business exploiting opportunities along the way and eventually ended up with a clear focus.

An exceptional experience was offered by **Sefar**, a company that had been producing silk gauze materials for filtration and printing for about 190 years.

Sefar, earlier called Dufour & Co., realized the opportunity offered by the rise of industrial processing, such as flour milling, that required a high-quality sieving process. As the company evolved, additional applications for its silk gauze were developed. Over time, screen-printing was added, utilizing the same production machinery.

Sefar's focus began to be articulated around its evolving core competency of producing 'highly precise holes.' Defining its focus based on its experience of almost 200 years, allowed the company to stay clear of more fashionable or glamorous segments. Fabric produced for processes where superior quality would mean longer filter life and superior filtration results led Sefar to a focus based on its accumulated experience as guidance for directions to develop. Its focus did not change over its long company history.¹

Plumettaz offered the example of a company that had to evolve its focus over its history of almost 100 years. Starting in 1923 and quickly becoming a supplier of packaging machinery to Nestlé, Switzerland's largest food producer, the company was forced to refocus when the packaging machinery business was pulled in-house by Nestlé during the recession of the 1930s.

Plumettaz, looking for opportunities turned to the steep vineyards in its region and developed cultivating machines that could pull ploughs upward through the vineyards. The winching mechanism developed for the ploughs led to other opportunities eventually pointing the company to capitalize on its winching expertise and allowing it to move into cable-laying application. The Plumettaz experience demonstrates that once a core competency has been developed, it can be moved into other applications areas giving the company a new focus beyond the competency alone.²

Whereas the two previous examples show companies that either stayed with, or evolved, their focus over time, **Jura** demonstrates the experience of a deliberate shift in focus. Founded by Leo Henzirohs, who was a tinkerer concentrating on electrical appliances for home use, the company grew beyond coffee machines by adding irons, toasters, and even refrigerators and washing machines, all for the Swiss market.

When increasing international competition caused **Jura** to lose competitiveness, a new management team focused on its best-selling product, an espresso machine for home use, developed a new model and made this new line its best-selling and ultimately globally successful product. The exercise, which resulted in substantially reducing the product line and focusing on a single family of automated espresso machines for home use, represented an abrupt departure from Jura's previous business practices of offering a full line of home appliances.³

¹Adapted from Sefar company profile.

²Adapted from Plumettaz company profile.

³Adapted from Jura company profile.

The examples of **Sefar**, **Plumettaz**, and **Jura** demonstrated that there were not only different pathways towards reaching a business focus strategy; for example, inherited focus to respond to market changes or deliberate focus for greater competitiveness, but also different types of focus within those business strategies. While **Sefar** focused on a core competence based upon its production technology (holes), **Plumettaz** focused on the exploitation of a technology (winching) and **Jura** concentrated on a single machine and application (making espresso).

Consequently, the next section will offer a typology of focus, categorizing the different ways companies have found focus and describing some of their experiences with them. As indicated before, the authors recognize that any of these companies could also be seen as pursuing more than a single type of focus. For clarity's sake, the one company/one focus type representation was chosen.

Focusing Around Core Competency

Core competences have been a management concern ever since the concept was introduced by Prahalad and Hamel in 1990. The authors defined core competence as a “harmonized combination of multiple resources and skills that distinguish a firm in the marketplace.” Core competencies should provide access to a wide variety of markets, make a significant contribution to customer benefits through a product and be difficult for competitors to imitate.⁴

Among the companies researched for this book, several examples were found where a core competence served as the basis for building an entire company. The Prahalad and Hamel criteria were clearly met by two of our documented companies, namely **Sefar** and **maxon**.

Sefar leveraged its core competence of ‘highly precise holes’ into a large number of customer or industry application, all from a common technological base. Marketing its technical precision fabrics to a large number of user industries, such as electronics, graphics, medical, automotive, food, pharmaceuticals, aerospace, mining, refining and architecture, the company has managed to leverage a single technology into multiple customers groups.⁵

At **maxon**, emerging from a business of supplying components for electric shavers, a design team developed a range of small electric DC motors, including a patented process for an ironless rotor which doubled the efficiency of available motors and extended their product service life. The final step towards mass production came with the mastery and development of a special rhombic winding technology and the corresponding winding machine, which also became a patented process.⁶ **maxon**’s rhombic winding technology, and the development of automated winding equipment, proved to be a major breakthrough and a process that could not be copied by competitors, because the manufacturing equipment was not available on the open market. The resulting electric motors found their way into a large number of

⁴Prahalad CK, Hamel G (1990) The core competence of the corporation. *Harvard Business Review*, 68(3): 79–91.

⁵Adapted from Sefar company profile.

⁶Adapted from maxon company profile.

industry applications, from aerospace to medical, automotive, communication, consumer, instrumentation and industrial automation.

Other examples among the researched companies, *leveraging* a core competence include the following.

- **Komax:** wire stripping
- **Plaston:** injection molding
- **Burckhardt:** compression
- **Geistlich:** bone processing
- **Plumettaz:** winching
- **Sefar:** highly precise holes
- **Jura:** espresso machines

The success of this focusing strategy has depended on a company's ability to leverage its competence and technology into multiple applications, putting great emphasis on a skilled marketing and sales force that can reach into many application industries. To the extent that a company can be successful at establishing such a sales expertise, a higher business volume can be pursued, which will drive profitability and the ability to withstand competitive pressures.

Pursuing a Technology Focus

When companies define their focus strategy around a given technology, the resulting approach and business configuration differs. Technology is usually defined as applied science and may combine a number of tools, equipment, instruments, devices, and systematic skills to produce a desired effect. The acquisition of such a technology often accrues over time, can be proprietary, and can build a significant hurdle for others wishing to enter the same technological space. Mastering a technology is thus broader than just a product concept, is different from understanding a certain industry or customer group, and is usually part of a company's fundamental DNA.

Since mastering and maintaining a cutting-edge technology requires considerable resources, companies that pursue this course invariably attempt to monetize their technology into multiple markets or applications to maximize return. From the companies that took part in this research, two of which offer a clear example of this type of focus are featured here. Geneva-based **LEM**, although its products invisible to consumer's eyes, were nonetheless indispensable regarding a full range of power electronic applications. It was founded as a limited company in 1972, under the name of Liaisons Electroniques-Mécaniques LEM SA. In 45 years LEM grew into a global company with sales of CHF 321 million (2019) with a single-minded focus on exploiting its technology around power electronics.

LEM was a manufacturer of transducers for measuring and sensing of electrical parameters, such as current and voltage, used in a broad range of applications. Users relied on LEM for functionality in a wide range of applications, from variable speed drives for electric motors to power supplies for industrial electrical equipment. LEM transducers were used in AC/DC converters, uninterrupted power supply systems, micro turbines for wind and solar power generation and, increasingly, in a full range of electrical and battery applications for automotive industry. By monitoring electric current and voltage, electronic systems could optimize use and regulation of power, ensured safe operation and identified problems before they caused equipment failures.

Although LEM was focused on selling components, or transducers, the company had moved into many industry sectors where company or product-specific components were sold. Railway and trackside applications were the first segments penetrated. Later, industry applications, such as for robots for energy and automation, eclipsed the rail sector, followed by a wave of renewable energy applications in solar and wind. More recently, the automotive sector was gaining in importance. Given their different economic cycles (from early to late cycles), the variety of sectors provided for diversified businesses and stable sales while maintaining product focus.⁷

LEM's approach then was to exploit its technology in a multitude of application niches. By emphasizing standard components and placing them into a catalog, the company could offer a large number of components for different applications based on its main technology. This technology was at the base of the company since its creation in 1972 and continued to bear superior economic rewards.

EAO's journey to find its technology focus differed from LEM's. EAO had actually started in 1947 making electrical transformers when a customer brought a new idea to the attention of the company's founders.

One day, an electrical cabinet maker who sourced transformer from **EAO**, told them about problems he had with switches in his cabinets. They saw an interesting business opportunity since one of the founders knew something about switches and push buttons from his own work experience. Approaching the challenge with an innovative spirit, they developed a push button made from new plastic materials, with a small lamp fully incorporated, and finally miniaturized it to a new standard compact size. There were no such products with that combination of features on the market in 1958.

The lighted buttons found success, and the reaction of the EAO founders was: "Let's go and make some more." The suggestion of the electrical cabinet maker eventually led products around human-machine interfaces (HMI) that became the dominant business of EAO. Technologically, HMI buttons were at the intersection of mechatronics, electrical, mechanical, and software technologies. The plastic components had to be molded to a precision of 1/100 mm, placing great demands on molding operation and miniaturization.⁸

EAO grew as a company to CHF 130 million in sales producing some 30 million push buttons annually. These products were sold into a multitude of application segments, including railways, transportation, automotive, and machine automation. EAO has become exclusively focused on exploiting its technology for HMI applications, divesting earlier business segments.

⁷Adapted from LEM company profile.

⁸Adapted from EAO company profile.

Other technology-focused companies include the following.

- **Filtrox** on depth filtration technology
- **FISBA** on optical technology
- **u-blox** for positioning technology
- **LNS** with its bar feeding technology
- **Mikrop** on optical technology

Companies pursuing a technology strategy, as will be seen later, found easy entrance into exploiting their technologies into a platform leading to multiple product variations and multiple application segments. Doing this off a single technology makes for a narrowing of focus.

Focusing on a Single Market

Some of the SME companies decided to concentrate on a certain market. Markets are more narrowly defined than industries and allow for a concentration of efforts. Companies that follow this approach serve their markets with a bundle of products but, essentially, all of them focused on a selected target market.

During most of its long history, **Sécheron** had concentrated on equipment for the electrification of the Swiss Federal Railways, or **SBB**. The company focused on the electric traction of rolling stock, railways, trams, and metros. All of its three main businesses were thus directed at the rail business where the company could leverage its strong heritage in this sector.

Sécheron's component business involved the design and manufacturing of standard and customized components, as well as more complex subsystems, where the company integrated its own, or third-party, components into compact high-voltage enclosures convenient to supply and easy to install.

In the systems business, **Sécheron** had captured the position as the world's leading supplier of electrical equipment for DC traction substations with an installed base across many countries.

The business for on-board electronics was the smallest of the three businesses. Operated under the **Hasler** brand, for more than 120 years, the company was the market leader for speed acquisition systems, for speed displays and train data recorders. The market approach differed from the other **Sécheron** businesses in that it required a different sales and distribution network but was aimed at the same market, namely controlling rolling stock.⁹

Sécheron, and its three operating divisions, were all focused on a single market, namely for electric rolling stock or trains. The company was offering, however, a large bundle of products for this market, combining different technologies.

Felco, the producer of pruning shears for the agricultural market, with special emphasis on wine growers, offered another example of a single market focus. The

⁹Adapted from **Sécheron** Groupe company profile.

agricultural market used pruning shears for a number of activities, including pruning trees. With a focus on this market, Felco offered a large number of pruning products, from single hand to dual hand, from manual to power-assisted, but the main purpose always being used in an agricultural environment.

As the **Felco** story goes, a wine grower approached Flisch asking for a hand-held pruner for his vines. Since he could make such good tools, maybe he could also make one for his use in the vineyard. The first design, named Model 1, made of forged aluminium, interchangeable parts and of high durability, became an immediate success and other wine growers asked for the same. Before long, a growing business developed for these pruning shears that have become the leading product for Felco. The follow-on model, Felco 2, looked the same as the original model but was produced differently. It came coated with the now classic red handles. The Model 2 remained the company's bestseller since 1948 to this day, producing 3,000 per day, retailing at CHF 50, approximately three times the price of cheaper imports from Asia copying Felco's design.¹⁰

The Felco experience not only documents a strategy for a single market, but also shows that this concentration can reap considerable rewards when the business expands globally. However, it does not mean that an industry focus on agriculture or vineyards would result in sales to this market alone. The company's experience shows that its products were used in segments other than winegrowing and even for non-agricultural purposes. However, true to its focus strategy, the company usually abstained from exploiting such outliers.

Impressive is **Selectron's** path to its focus on in-train automation. The company at one time served three different markets, namely factory automation, building controls, and train electronics, yielding no significant synergies. Through efforts of concentration, Selectron navigated its way to focus on train electronics as its single market, eventually phasing out the other two.

Selectron's initial competitiveness as a supplier to the Swiss Railway was based upon its willingness to varnish the electronic controls and select ruggedized components to meet the stringent requirements for train operation. If the PLCs were not varnished, reliability of the equipment was not assured. Condensation caused by temperature differences as a result of tunnels, as well as dust collected from steady use, could result in short circuits in the system. Major automation suppliers were not interested in taking this extra step, forcing the railway operator to use heavy protection boxes instead. New European regulations (EN 50155) required that electronic controls withstand operating temperatures from -40C to +85C, compared to 0C to +50C for normal applications. Controls had to be vibration and shock proof, protected from interference and withstand humidity in tunnels, all of which would not be achieved from standard control suppliers.

The fact that in the past, to compete in the machine tool automation segment, the company had consistently reduced the size of its controllers helped to make its products fit into the tight spaces of railway cars. Efforts were concentrated on the railway automation segment since the Swiss Railways had placed a five-year contract to supply controls units for a large refurbishing contract for older trains. Stopping efforts in off-target segments freed

¹⁰Adapted from Felco company profile.

capacity in the development and sales departments needed to drive the effort in the railway segment labeled ‘In-Train Automation.’¹¹

Accounting for just 15% of sales in 2000, Selectron managed to grow a small train refurbishing business for the Swiss Railway of about CHF 2.5 million into a growing company of CHF 75 million in 2018, occupying a significant position in the international in-train control market.

Other single market-focused companies included the following.

- **Pilatus** on the aircraft market
- **Thermoplan** on the gastro market
- **Geistlich Pharma** on the dental market
- **Kuhn Rikon** on the kitchen and cooking market
- **Caran d’Ache** on the market for writing and drawing

Focusing on a single market provides, and necessitates, in-depth knowledge of the operating conditions of a company’s customers. Accumulating such deep understanding across a number of markets would dilute attention and spread scarce market resources across too many targets.

Five different ways of focusing have been described here; focus on either an industry, a business, a competency, a technology, or on a market. Each of these paths has its own value and will lead companies to advance into different directions. The next chapter will introduce a different focus category, namely the concept of customer franchise—a concentration on a single customer or client group—and will illustrate why this offers yet another perspective to these companies.

Open Access This chapter is licensed under the terms of the Creative Commons Attribution 4.0 International License (<http://creativecommons.org/licenses/by/4.0/>), which permits use, sharing, adaptation, distribution and reproduction in any medium or format, as long as you give appropriate credit to the original author(s) and the source, provide a link to the Creative Commons license and indicate if changes were made.

The images or other third party material in this chapter are included in the chapter’s Creative Commons license, unless indicated otherwise in a credit line to the material. If material is not included in the chapter’s Creative Commons license and your intended use is not permitted by statutory regulation or exceeds the permitted use, you will need to obtain permission directly from the copyright holder.



¹¹Adapted from Selectron company profile.

Focusing on a Customer Franchise

The concept of a customer franchise is relatively new to the marketing field and refers to the hold a company has on a given industrial user group. The group needs to be clearly defined and is best described as a group of professionals, or businesses, who perform a singular function. For a franchise to be effective, the products or services need to be crucial to the execution of the business activities of the industrial user group, the professionals, or other businesses. This is about the products that are really central to the business, not about a legal relationship.

This type of customer franchise concept is not to be confused with a consumer brand franchise often used in a business-to-consumer (B2C) marketing environment. That version of the franchise will be addressed later in the book. In this research, several companies were discovered to focus on customer franchises—supplying these businesses, or companies, with key equipment, components, or products.

Building a Customer Franchise Around Industries

Komax, serves as an example of the approach of building a customer franchise by targeting companies involved in cabling, or wire harnesses, used in a number of industries. Gradually, the Komax equipment for creating wire harnesses became central and essential to wiring firms supplying original equipment manufacturers (OEMs) with pre-manufactured wiring for easy and quick installation in assembly operations that had previously been done manually. As a result, a new group of companies—wire harness manufacturers—emerged.

Although the first **Komax** equipment was intended for a range of application segments, it was the automotive industry that emerged early on as a major user of Komax equipment. Wiring a car efficiently and to a highquality standard had always been a challenge. Automotive OEMs increasingly moved this capability to wire harness manufacturers who

assumed the role of Tier One suppliers. A compact car ‘consumed’ about 1300 wires, of which 25 percent were twisted, for a total length of 2000 meters. There were about 250 plug housings to connect and about 2300 crimp contacts. Weighing more than 30 kg, the harness cost about CHF 400 to produce. For a full-sized car, the numbers were about 50 percent to almost twice that.

The megatrends in the automotive industry contributed to a growth of wiring. Additional safety features required more sensors to connect. The growing ‘electrification’ of automobiles contributed to a marked increase in cabling per vehicle. Increasing complexity and ever more power supply systems required more automation and thus, more cabling. The increasing quality standards demanded more automated solutions. All of this tended to increase the market for automated wire processing and equipment, such as the ones produced by Komax. Given what wire processing machinery could do for the manufacturers of wire harnesses, it was no surprise that harness manufacturers for the automotive industry were the largest customer group of Komax.¹

Once **Komax** had established a firm position for its cabling equipment, the company began to expand its role with cablers by continuously enhancing its services, moving along the cablers’ internal activity cycle. This expansion was executed through a series of acquisitions that brought additional equipment providers in-house.

Komax’ strategy of focusing on wire processing systems came with an expanded scrutiny of its industry that created many growth opportunities. The company analyzed the entire wire harnessing production cycle and the time spent on each step. While important from an efficiency point of view, cutting, stripping and crimping, the core activities of Komax systems, accounted for only 20 percent of the time needed to create a wire harness in the automotive industry. Routing and pre-assembly / taping accounted for 28 and 25 percent, respectively.

New insights came from investigating the entire value chain of its customers, going beyond what had been the focus of the initial wire processing systems. The strategy was now clear that Komax wanted to expand the ‘share of wallet’ of its main customers and enter other value chain steps previously left to other companies. Between 2013 and 2017, Komax grew its wire processing business from CHF 254 mio to CHF 409 mio, with more than 80 percent originating from the automotive sector alone.²

Building a Customer Franchise Around Institutions

Thermoplan, with its automated coffee machines geared for the hospitality industry, pursued its own version of building a customer franchise among coffee chains, restaurateurs, and institutions.

From inception, **Thermoplan** was following a business-to-business (B2B) model supplying professional kitchens, restaurants and hotels. This model was maintained, and the bulk of its equipment went into professional use, setting the company apart from other espresso machine suppliers, such as Jura, another Swiss company focusing on espresso machines

¹Adapted from Komax company profile.

²Adapted from Komax company profile.

for in-home use. With Thermoplan's two main lines designed for either a 150 cups per day or 500 cups per day environment, the company clearly had professional users in mind. Today, about 50 percent of Thermoplan sales were to customers purchasing dedicated custom-made coffee machines. The Starbucks volume was put at 30 percent of sales. The other half of company sales were made with its standard Black & White Model Range, now in its 4th generation, distributed to hotels and restaurants in a B2B environment.³

For companies pursuing the focus on a given customer franchise, a broad product line is necessary to provide an enlarged service. The analysis of a customer's activity cycle, whereby each step in the manufacturing process is analyzed to probe for an enlarged footprint, offers insights into ways to become increasingly important and, thus, indispensable to the customer. **LNS** also moved along this path to enlarge its business for bar feeders.⁴

By the late 1990s, **LNS** had developed the largest global sales network for bar feeders. With margins declining due to emerging competition, the company began to think about ways to monetize its large sales force by piggybacking on related products. At this time, Turbo Systems Inc., a US-based company selling chip management systems to the same customer base using **LNS** bar feeders, approached **LNS**. Chip management systems were also engineered into the OEM machines and automatically collected the chips created from machining the metal bars. The US company had about the same amount of sales as **LNS** but did not have its own sales force.

Integrating Turbo Systems chip collectors with the **LNS** sales force proved to be a major challenge and required quite a bit of re-engineering as chip collectors were more difficult to adapt to various CNC machines, a necessary step for **LNS** to take those products global. It took about five years until the **LNS** sales force was comfortable selling Turbo Systems chip collectors to their bar feeder customers. In 2002, **LNS** acquired Turbo Systems. Today, chip collectors accounted for about 30 percent of global **LNS** sales with about 10,000 units sold annually. In 2011, **LNS** took another step in acquiring an Italian company, a manufacturing of air filtration systems, that could be attached to the same CNC machines using bar feeders and chip collectors. Work holding and coolant management systems were completing the strategy of a one-stop offer for CNC machine operators.⁵

Companies that built strong customer franchises benefited from close connections to their customers and could exert considerable market leverage due to their importance to a customers' business. Enlarging the role in its customers' business puts pressure on the supplying company, as a broader set of products, and at times even additional technologies, require more resources. At the same time, it serves as a powerful competitive deterrent.

³Adapted from Thermoplan company profile.

⁴See **LNS** company profile.

⁵Adapted from **LNS** company profile.

Building a Customer Franchise Around Professional Groups

An alternative use of the concept of customer franchise is the building of a market position around a professional group, working either independently or as part of a company. This is particularly important when the target customers become so reliant on the supplying company's products that they can specify the supply source. Several of the researched companies have succeeded with this type of focus. Among those are Max **Felchlin** focusing on chocolatiers worldwide, **Bachem** on researchers at Pharma companies, and **Medartis** with its trauma implants concentrating on orthopedic surgeons.

With its couverture products, **Felchlin** focused the enterprise on the world's pâtissiers and chocolatiers, cementing a hold on that professional group not only by producing specialized products but also by offering a unique chocolate university where specialists from all over the world came to learn the latest techniques.

When Max **Felchlin** created his honey trading business in 1908 in the town of Schwyz, there were few indications that this little trading company would someday dominate the world of pâtissiers and chocolatiers with its Couverture chocolate. The Felchlin's created the foundation for a company that professional creators of pralines and other chocolate specialties would all over the world come to rely on for a key ingredient for their creations. The company grew, step by step, to encompass about 150 employees with sales estimated at CHF 60 mio, earning the highest praise for its quality and creativity. That in the land of large global chocolate companies, a small niche competitor should survive and blossom over more than 100 years deserves special attention.

Because Felchlin marketed complex products that required considerable explanation for a given selection of tastes, and how to apply them, Felchlin created Condirama in 1988, located in Schwyz and equipped to show professionals how to do it right. The school attracted 1000 to 1500 visitors annually. Swiss customers enrolled in one-day courses and did not require overnight stays. International customers, however, enrolled into one-week courses requiring a residential period. Condirama was run as a cost center. Swiss-based customers, when ordering products, received points, a form of frequent flyer miles, which could then be used to gain access to the courses at no additional cost. International customers, or users, were typically sponsored by their importers for the trip, and Felchlin covered local food and lodging costs during their stay.⁶

Bachem had built an entire business on the model of serving a distinct customer group in the pharmaceutical and life sciences industry. When the company started, research scientists had to create their own peptide research products. Following its own 360-degree business model, Peter Grogg, the Bachem founder, and a former lab technician, realized that a new industry could be created by stepping in and taking over this part.

Ever since its founding in 1971, **Bachem** had taken the lead in creating a business model that was new in the life sciences industry. Up to that time peptides had been produced internally by each company, Bachem created the market for a merchant supplier doing business with multiple life sciences customers. Over time, the peptide supply moved from being almost

⁶Adapted from Max Felchlin company profile.

entirely captive to about 70 percent merchant based, a major change for the industry. Bachem articulated its approach as the 360-degree business model by surrounding the entire life sciences product and research process with products and services at all steps, ranging from initial research to include pre-clinical development, clinical development and the supply of peptide drugs up to commercial scale introduction.

To the research community, Bachem offered its 6,500 products, all made in-house, available from stock and to be ordered through a web shop. It represented the largest such product line in the industry. To the pre-clinical development teams of biotech and pharmaceutical companies, Bachem was able to offer custom-made peptides for the extensive panels needed in the process of further refining target compounds, involving close partnering with life sciences companies. During clinical development, when the target compound had been identified, Bachem engaged in close collaboration around the optimization process needed for development of formulations, scale-up of production and eventual validation. In the launch phase of a new drug development project, Bachem was able to act as the contract manufacturing organization by providing manufacturing up to full-scale volumes on a flexible basis, particularly important to customers in early launch when required volumes were difficult to forecast.⁷

Medartis, a relative newcomer to the world of orthopedic and trauma implants, focused its entire marketing on orthopedic surgeons, offering not only implants but also surgical aids, training, education, and support, thus becoming an indispensable partner to the surgeon.

The **Medartis** business model ran along three different but coordinated tracks involving professional training, placement of surgical sets in hospitals, and billing for the actual use of implants after surgery. Through the partnership with the International Bone Research Association (IBRA) formed in 2004 in Zurich by eighteen clinicians, a large number of educational programs and training programs were offered that treated the indications covered by Medartis implants. Offered were symposia, workshops and satellite-based events that had attracted more than 12,000 participants since 2008.

Surgical sets were placed through Medartis in cooperating hospitals, consisting of surgical instruments and implants for a large number of different surgical procedures. These sets represented a significant investment by Medartis as sets were placed on consignments and did not immediately result in direct billings. The third and final part of the business model was based upon actual use of implants and surgical instruments from sets on consignment. When kits were replenished, the used portion was billed to the hospital and represented Medartis actual sales volume.⁸

Companies such as **Medartis**, **Felchlin**, and **Bachem**, marketed directly to their respective customer franchise. However, the purchase orders, shipments, and invoice/billings were made to the companies that employed these professionals. Having direct access to professionals and being able to explain their products to the using professional, enhanced the hold these companies could exert on those professional users. It promoted customer loyalty and preference over the long term. An expanded service offering, going beyond physical products, was also found to be a prerequisite to make this work. Explains Willi Miesch, CEO of Medartis, *It is best*

⁷Adapted from Bachem company profile.

⁸Adapted from Medartis company profile.

*to control selling, education and training to direct the business. What is essential is exercise influence control.*⁹

Adopting a Solution-Based Customer Franchise

In the previous focus strategies, the companies discussed brought products, or technologies, to a given industry sector or customer groups. Some companies have, as an expansion and partly as a defensive strategy, developed entire systems, moving from product-based offerings to a systems business. The firms enhanced their core product with other offerings to combine them into a complete system while always maintaining the same customer focus.

Lantal, the specialty textile manufacturer with a heavy emphasis on the transportation sector, is a case in point where the systems focus was implemented step-by-step to move from textiles to airplane seat covers to other parts of the cabin interior.

The more customers **Lantal** was able to win, the more likely some of these customers were to ask whether it could also offer the right carpet, as the quality of its core products was very good. When the opportunity emerged to take over a carpet weaving mill in nearby Melchnau, which had run into difficulties, owner Urs Baumann decided to buy it in 1985. From that year on, the company could offer not only seat covers but also carpets from the same source.

It is important to know that a carpet machine could only be used for the production of carpets and not for other fabrics. For airplane seat covers, flat weaving was used, which was completely different from carpet weaving or plush/velvet weaving applying different technologies, employing different machines and utilizing different processes. In addition, Lantal produced handmade carpets for very special purpose applications. Overall, Lantal became the only company in the world which was able to offer products based on four different production technologies from one source: carpets, velvet, flat woven and handmade carpets. Thus, Lantal was able to completely plan the entire interior and to cover every product within a cabin while its competitors could only offer individual products and had to cooperate with other suppliers to offer broader solutions.¹⁰

To qualify as a complete solution supplier, Lantal had to expand beyond its traditional weaving technology by adding new capabilities, either through acquisition or expansion, in an industry where suppliers usually concentrated on one technology only. This added complexity to its business, which was partly offset by training its weaving staff on multiple machines to be able to reassign them as demand required. Such manning flexibility could only be achieved with a highly qualified staff.

⁹ibid.

¹⁰Adapted from Lantal company profile.

Employing a System-Centered Approach

Different pathways were chosen by **Komax** and **Oetiker**, two companies with a concentration on the automotive sector. Komax, already in the cabling equipment business with cabling companies as its main customers, added downstream equipment with which customers could supplement their cable harness producing lines, thus offering a complete system solution.

The majority of **Komax** customers were wire harness manufacturers who processed individual wires, still predominately by hand, into a wire harness that was delivered to the automotive companies (OEMs). Komax offered these companies a wide range of solutions and systems for automated and more efficient processing of wires, as well as for taping and testing the harness. Komax equipment was used in the cutting rooms, at the pre-assembly stage, and during taping and testing. Komax also supported its customers along the entire value chain, from planning to delivery, with the Komax MES. This software automated planning, controlling, monitoring, and analysis of all resources and production processes. This had the effect of optimally deploying machines, materials, and employees with the goal to complete deliveries in line with deadlines and at the specified quality level.¹¹

At **Oetiker**, the company was producing the clamps used in large numbers by automotive OEMs and Tier One assemblers. While Oetiker produced these clamps in its own plants located around the world, the company began to acquire other firms that offered clamp installing tools.

Since **Oetiker** produced clamps needed to be assembled in large quantities into different parts by automotive sub-assemblers, the company used acquisitions to bring together a set of tools and equipment that could be used for the assembly of clamps. For this purpose, Oetiker acquired Allert in 1997, since 1980 active in fastening, for the automotive sector, as well as supplying hinged steel belt conveyors. Allert continued to operate under its own brand name and was kept as a separate legal entity in the form of a fully owned subsidiary.

Levi Peterson, a Swedish company active globally in engineered fastening devices specialized for commercial vehicles, was acquired in 2014 and has operated since then as Oetiker Sweden AB, combining sales and production operations on the same site. Also, in 2014, Oetiker acquired Rostra Tool Company, based in Connecticut, US. Rostra, with a 150-year history, marketed its flagship brand 'Sargent Quality Tools', hand tools for crimping, pressing, cutting and stripping to wholesale distributors and other industrial users. For Oetiker, the hand tool lines added to its system approach serving clients not only with connecting solutions but also the required installation tools. Rostra also held a strong position in the PEX plumbing connection market, another important strategic objective for Oetiker. The company was now operating as Oetiker Tools, but was keeping the Sargent brand names for specific products.¹²

Becoming a system supplier brings new complexities. Whereas a product supplier can exploit a single technology into multiple application markets, the system supplier is confronted with *leveraging* additional technologies, or products, into a single

¹¹Adapted from Komax company profile.

¹²Adapted from Oetiker company profile.

user segment. This requires a focus on one, or few, customer groups, as systems tend to be narrowly engineered from an application point of view. Furthermore, the added business expansion favors larger firms, usually from CHF 100 million and more.

Consumer Franchise Focus

As mentioned previously, the building of a consumer brand franchise in a business-to-business (B2B) environment was a more commonly known concept of franchise building. The documented firms who were mostly B2C did engage in such brand marketing activities, and those firms could be said to have been successful at building such franchises. We describe the brand franchise building activities in Chap. 13 by putting the spotlight on the global branders **Ricola**, **Jura**, **Caran d'Ache**, and **Kuhn Rikon**.

Contrary to the B2B customer franchise builders, the consumer franchise builders target a broader sector of the market. To make this form of focus work required a single brand name and brand image building that connected with the target consumer segment.

Caran d'Ache and **Felco** covered both professional users and individual consumers. For Caran d'Ache, the individual consumers represented the larger group, whereas for Felco the home users, or do-it-yourself (DIY) gardeners, were a smaller group compared to the professional wine growers. That means that those two companies had to manage both forms of franchise building. Among the research group, however, these were exceptions.

Plaston also marketed to both industrial customers for the tool storage boxes and individual household customers for its air washing products. Using a separate brand name, **Boneco**, made Plaston a dual brand company.

The two previous chapters have outlined the many different ways SME management chose to focus their businesses. This description might have created an impression that company managers select their focus in the form of a deliberate process, getting to their desired position in a single step. The next chapter will show that for many SMEs, the focus is a journey, not the result of a singular decision. How such a focus journey is navigated has a lot to do with their eventual success.

Open Access This chapter is licensed under the terms of the Creative Commons Attribution 4.0 International License (<http://creativecommons.org/licenses/by/4.0/>), which permits use, sharing, adaptation, distribution and reproduction in any medium or format, as long as you give appropriate credit to the original author(s) and the source, provide a link to the Creative Commons license and indicate if changes were made.

The images or other third party material in this chapter are included in the chapter's Creative Commons license, unless indicated otherwise in a credit line to the material. If material is not included in the chapter's Creative Commons license and your intended use is not permitted by statutory regulation or exceeds the permitted use, you will need to obtain permission directly from the copyright holder.





Focus Does Not “Just Happen”

For many of the sample companies, the focus did not come as a result of an elaborate, expressly stated strategy process. They did not engage consultants to ask them what to do. Nor did they engage in any extensive internal meetings. They also did not pour over extensive customer data. No statistical or Big Data analysis was employed. Yet, it did not simply fall into their lap, either! Focus takes effort.

Finding Focus Is a Journey

This research will disappoint those readers who believe that focus consists of one decision where companies hit directly upon the right, and final, combination. Rare is the experience of **Ricola**, where the company embarked almost from the beginning on a focus, which is still being followed today. For most companies, the focus practiced today was settled on after several steps and, at times, only after some painful decisions. The experience of **Jura** described earlier, in Chap. 8, is a case in point, where the management’s focus decision meant eliminating most of the company’s previous product line in order to exclusively concentrate on automated espresso machines.

While first developing their business, many company founders followed a narrow path, sometimes tempted to move into different directions once they discovered a potent development or product line. When founders succeed while still moving in their initial direction, they can sometimes get carried away, perhaps even thinking themselves invincible, only to realize later that the risks of losing focus can threaten their entire business. Focus can be likened to pruning a tree or learning how to say no. When some companies face a proverbial crisis of opportunity, returning to selectivity can be difficult. Invariably, this involves selling parts of the business, or company, to narrow the focus on other parts. **EAO** illustrated this process.

When the second generation at **EAO** with Kurt Loosli, Jr., joined the company, the product portfolio included a wide range of products. Older generations of transformers were produced next to a variety of platforms of command and control devices, primarily illuminated push buttons. The company decided to sell off all non-core businesses, including transformers,¹ and to concentrate exclusively on command and control devices. The company adopted a new vision of completely opening the range of switches to become a leader in HMI products, a business area that had not yet completely evolved. Leadership for EAO did not mean to be the largest in volume but the best in quality, fully addressing all possible interfaces based on the three human senses of feeling, hearing and seeing, while strongly focusing on applications within most demanding environments.²

EAO was thus spinning out its older, initial product line to concentrate solely on its new opportunities in HMI interfaces, the source of all of its business today. The company had moved from the initial transformer business to a combination of transformer and HMI devices, to then become solely focused on the latter by dropping the first business.

For its first 30 years, the journey of **Komax** encompassed its original cable wiring equipment which grew rapidly and was focused on the automotive industry. Forays into other industries, while looking at first promising, did not materialize and the company returned to a more singular focus by divesting its new ventures.

Around 2005, **Komax** was also looking at other industry applications for growth. Two major sectors were targeted, the medical sector and the photo voltaic (solar) sector. Both offered some of the features that demanded Komax-type wiring machinery, and both were more heavily into assembly automation. While both the medical and the photo voltaic sectors experienced considerable growth early on, exceeding growth in the industrial cable wiring sectors, long-term success proved difficult to secure. The experience during the financial crisis of 2008–2009 might have contributed to the search for alternatives to the wiring business, particularly in the automotive sector. Komax experienced a sales decline of as much as 55 percent from automotive customers during that period, whereas sales in the solar and medical segments remained relatively stable.

In the medical sector, Komax acquired Ismecca, a company active in assembly automation and located in La Chaux-de-Fonds, employing about 120 people, with sales of about CHF 42 mio. Although initial results were promising, the Medtech business never did take off as expected. Similar developments were registered in the solar business. In 2013, Komax reviewed its strategic options leading to the decision to step out of both segments. At that time, wiring systems accounted for 75 percent of sales, the rest going for Medtech (20 percent) and Solar. Both segments had a much lower profitability than the core wiring segment. The solar business was sold as part of a management buyout, MBO, in 2014 and the medical business was sold in 2016 to an Italian buyer.³

Filtrox underwent a more drastic refocusing. After steady growth and expansion from filters into equipment and processes, the company reached a point where carrying on along both vectors had reached its limits.

¹The spun-out transformer business continues to this day under different ownership.

²Adopted from EAO company profile.

³Adapted from Komax company profile.

For decades, **Filtrox** had two large business segments: Filter Media and Machines & Plants. Machines & Plants had two further parts. One was media-carrying equipment, which was the smaller part and accounted for about 10 to 20% of sales. The other part was systems that did not require any filter media. As a result of acquisitions and private investments, Filtrox had grown strongly in the 1990s and at the beginning of the 2000s. Filtrox production covered a broad portfolio, from machines such as wine presses to depth filters for various applications. The company realized that Filtrox was no longer able to cover such a large portfolio and stay innovative. Every product had to be improved constantly, a costly process. In addition, the filter systems for breweries were getting bigger and bigger, and to handle such large individual projects became difficult for a small firm in terms of risk and resources.

If the product portfolio is too broad, we can no longer invest into enough R&D for all products. Then we'll stay technologically stationary and will be overtaken at some point. If we are to remain innovative, we have to specialize (Rusch, CEO).

Filtrox decided to divest the engineering part of the company. The main reason for selling this business unit was its profitability, which was significantly lower than that of Filter Media. In addition, they wanted to further minimize risk, since they had pursued large individual projects in the Non-Filter Media sector and thus had corresponding longer cycles. The markets had diverged and there were too few synergies between them. Plant construction followed a different logic than the filter media business. One was a classic distributor business, the other a direct business which needed a different approach and other people in sales. Filter Media were considered core business. Everything not related to this core business was sold in 2012. In the process, the company lost almost half of its turnover and, in St.Gallen, employment was reduced from 150 to 90. After the split, Filtrox became more innovative and grew faster than before, achieving double-digit growth in its core business. All resources could now be directed to one business area, whereas in the past it had to be split between two. In 2020, Filtrox had employed more staff than before the spin-off, but fewer in Switzerland. Of the 350 employees worldwide, 90 were located in St. Gallen.⁴

It's a bit of a special story, a company that develops in this way and then almost cuts itself apart, virtually taking out a large part of the company as a whole so that the rest can develop better. Everybody prefers to get bigger and bigger. But this cut was necessary to generate growth again (Rusch).⁵

Employing Multiple Layers of Focus

Thus far, the various types of focus have been addressed as if they were singular choices. The typology of focus can be based on industry, business, core competency, technology, and market or a customer franchise, including solution and systems. Most companies researched were employing more than one type of focus, thus layering several focus types together for optimal configuration. Moving from an industry type to a solution type focus greatly affects the breadth of choices offered to customers. No SME can afford to be active in all industries, enter all markets, develop all technologies, in addition to expanding to a customer franchise model at the same time and offering complete solutions for all these pathways. The key is restriction, elimination, and reducing choices to *focus on the right focus*.

⁴Adapted from Filtrox company profile.

⁵Ibid.

As will be covered in later chapters about Segmentation and Product Building Choices, there exist additional types of focus steps that cover the above aspects, implying that some firms layer a multitude of focus strategies to arrive at a competitive approach that is compatible with their resources and skills.

Reaping the Benefit of Focus

The sections about focusing have highlighted the benefits that stem from concentrating resources on a few core areas, which are defined by industry, technology, customers or wrapped around solutions, and a core customer franchise area. Particularly for SMEs, where resources are always tight, bundling them all in a single area makes the company more competitive.

As many of the documented firms manifest, the focus was almost a given during their early history. Many then succumbed to the notion that this focus might be too narrow and that several legs to the stool might be a form of hedging bets. After a strong start, companies such as **Komax**, **LEM**, and **Filtrox** expanded their market activity. Many of the truly focused firms investigated reached a state of focus only after such an expansion period. The divestments that often followed resulted in a substantial reduction of overall company size and sales, soon to be offset by rapid growth in the chosen core area.

At some companies, **C+M**, **Plumettaz** and **Rüeger**, for example, that process has not yet been completed and the width of their businesses suggests that a further tightening of focus might occur down the road.

In 2018, **Plumettaz** sales to the Telecom industry amounted to about 50 to 55 percent of total, whereas the other industrial applications together accounted for about 20 percent of sales. The rest came from the railroad segment (oil circulators) and from some remaining agricultural business. Denis Plumettaz, its Executive Director, called this their four-legged-stool strategy.⁶

Cendres + Métaux (C+M) could look back to a storied history of more than 130 years. Started as a small operation attached to a local pharmacy, the company gradually expanded its operation. Processing and machining precious metal parts gave it an entry into the watch industry and, later on, into the production of dental components used for crowns. Growing steadily over time to reach sales of about CHF 146 mio (2019), the company spread internationally and employed about 350 at its main operations in Biel/Bienne. The company had evolved into a medical component business, accounting now for more than two thirds of sales.⁷

Although a company might adhere to a given focus at one time, changes in the market or industry might require an alteration. This suggests that a chosen focus needs to be consistent with the prevalent megatrends that drive an industry sector. Once they change, a major redirection may become necessary. **Plumettaz**, one of the

⁶Adapted from Plumettaz company profile.

⁷Adapted from Cendres + Métaux company profile.

smaller firms cited above, found its agricultural plow-pulling market for vineyards disappear when the wine industry adopted the practice of letting the grass grow freely in the vineyards. On the other hand, companies such as **Jura** and **Thermoplan** benefited from hitching their fortune to the growth of the espresso and latte wave swapping over from Italy and literally circling the world.

Lessons from Focus Journeys

The loss of focus often comes as a result of opportunity pull, and particularly firms with strong technologies in multiple markets can easily succumb to the *crisis of opportunity*. For those who have found their way back to focus, or who want to avoid losing it again, there is just one important element to remember: Saying No! Saying no in order to avoid straying from the chosen path of staying focused is both an art, a skill and a resolve that needs to be practiced time and time again.

Focus determines the market space where a company qualifies to play or where the firm intends to play. Observing the 36 researched firms, the rule appears to be: play in one market space only. Those who play in multiple spaces clearly are the exception. When a change of focus becomes imperative, many companies take the difficult step to divest the operations from their earlier focus phase to insure that at any one time, only one market space remains in focus. This is a major difference from larger companies that may operate multiple businesses, competing in multiple market spaces and organizing themselves around several divisions.

Focus alone, as described in this chapter, is not singularly sufficient to narrow the activities of SMEs as documented. Given the chosen market space that is the center of focus, that market space still needs to be subdivided into segments. The researched companies confirm that it is not good practice to take on the entire market space for which a firm qualifies. Instead, further choices restricting activities need to be made.

The process of finding focus around a given activity, or part of the market, tends to make a big company out of a small company. That might sound counterintuitive, but it cuts to the heart of the purpose of focusing. SMEs can, by focusing, overwhelm even larger companies if the SME manages to put more effort, more products, and more variations into a well-described market space than a larger company. The resources of the larger company deployed outside the narrow, focused area of the small company often do not automatically yield a relative competitive advantage for the larger player. This is the point when SMEs can assume the stature of a giant. To find such a niche is one of the core strategic tasks for SMEs.

The discussion of focus in this chapter concentrates on outward-directed focus, as reflected in market activity. There are other areas of focus dealing with inward operations, ranging from purchasing, production, and other value stream activities. Those types of focus will be discussed in the appropriate chapters later on and will offer a chance to delve deeper into the concept of layering when both internal focus and market external focus are combined into a larger bundle.

The next chapter will discuss segmentation and segment choices. Clearly, there is some overlap between focusing and segmenting, which will be delineated and clarified to demonstrate why it makes sense to treat them separately.

Open Access This chapter is licensed under the terms of the Creative Commons Attribution 4.0 International License (<http://creativecommons.org/licenses/by/4.0/>), which permits use, sharing, adaptation, distribution and reproduction in any medium or format, as long as you give appropriate credit to the original author(s) and the source, provide a link to the Creative Commons license and indicate if changes were made.

The images or other third party material in this chapter are included in the chapter's Creative Commons license, unless indicated otherwise in a credit line to the material. If material is not included in the chapter's Creative Commons license and your intended use is not permitted by statutory regulation or exceeds the permitted use, you will need to obtain permission directly from the copyright holder.



Part V

Marketing Practices

The emphasis here is on the marketing processes as being distinct from the focus choices, which were dealt with in the previous Part IV. No business can survive without fully implementing sound and effective marketing. However, for small and medium-sized companies, such as the ones researched here, their resource profile dictates a careful approach and a clear sense as to where to put the emphasis. A clear segmentation approach helps target marketing resources and allow smaller SMEs to be competitive against larger players, anywhere in the world.

- **11 Segmentation Choices**

At the outset of this chapter, the need to treat segmentation as distinct from focusing is explained, why both are important, and why both have to be addressed. Successful segmentation implies choices and carving out a segment from a market space is something that requires skill and attention. Different types of segmentation practices by the researched companies are presented, ending with the description of what a true niche segment strategy entails. A link between segmenting and organization is also made.

- **12 International Sales and Distribution Strategies**

This chapter covers the history of the international market development of the researched firms and, additionally, how these companies established agent networks, built sales subsidiaries worldwide, or enlisted partnerships, as well as how they reacted to constantly changing market developments that required adjustments to their distribution networks.

- **13 Marketing and Sales Processes**

No different from many other larger companies, SME marketing, and sales processes have undergone constant changes. The chapter details how the researched SMEs dealt with the tension between marketing and sales, how they differentiated the B2B from the B2C environments and professionalized their marketing organizations over time. Examples from adopting key account systems and enlisting lead customers are also included.

Segmenting Markets and Selecting Segments

Segmenting markets is a critical analytical step and directly related to the selection of target segments. The choice of a focus strategy as delineated in the previous chapter is a precursor to segmenting markets, related but different. The focus choice is a higher-order activity; segment selection is more granular. Just because a company settled on a given focus does not automatically determine the segment choice. Just as for focus choices, segment choices are needed to prevent resources from being spread over too many activities.

Many of the documented firms were very clear and specific about their chosen segments, just as they were equally clear about the type of segments in which they would *not* engage. The segment was sometimes delineated to separate industrial from consumer markets or distinguish between professional users and home users. In some instances, the selected segment was quite narrow, utilized for products with very specific requirements.

Focus does not eliminate the need for segmentation!

Defining and Segmenting Market Space

To give market segmentation traction, companies have to be able to define their market space in creative and penetrating ways in order to make sure that the selected segments are consistent with how the segment is defined. Time and time again, the successful firms in the research sample demonstrated that their market space definitions served as powerful drivers for their segment selection strategies. **Felco**, the producer of handheld shearing tools, offers a good example.

Felco segmented its market space neither by crop (such as grapes), nor by application (such as electrical industry) alone, but by the function performed by its tools. The tools were offered for right-handed or left-handed users. There were tools for lopping bigger branches,

cable cutters, pruning saws, knives and even electric pruning shears. They included tools for electricians in the Netherlands, rose cutting in Ecuador, the garlic industry in the US or for cacao pruning, which took place twice annually and needed replaceable blades. Aside from function, particular attention was paid to ergonomics and user specifics: left hands and right hands, large hands and small hands and power-assisted tools were part of the portfolio as well.¹

Initially, we were only responding to demand suggesting so many uses for our tools (Nicolet, CEO).

Defining its market around the *cutting* function, **Felco** could, over time, define a number of cutting segments based upon its experience, client contacts, and business development. The majority segment that became the focus for Felco activities led to many product variations, but all derived from a single source—the function of pruning.

Felco's product line for its main functional segments of pruning shears, loppers, cable cutters and pruning saws is extensive. For pruning shears alone, 24 different models were offered, and for loppers 14. Five different models of pruning saws were marketed. For the function of pruning and grafting, the company offered 13 knife models; power tools (three models) were also part of the product portfolio. Several accessories were included to complete the portfolio, from sharpening tools to holsters.²

Felco demonstrates an important Follow-On Strategy resulting from segment selection. Once targeted, many of the researched firms crammed their selected space, or segment, with a large variety of product versions. At Felco, it was 24 models of shears for one function, pruning, subdividing the segment users into several narrower categories, and producing models for each. For the lopping function, usually involving the use of both hands, 15 models were offered. This cramming strategy, often for small segments or market niches, was one of the recurrent practices observed by the firms in the sample.

The company also illustrates how the identification of a segment function with the final professional user—the worker in the vineyards—builds a strong connection to the product, creating a powerful customer franchise around a tool crucial to the vineyard worker. Adding additional accessories for the user complements the customer franchise and tends to create long-lasting bonds with him or her. In the final analysis, a company such as Felco comes to the point of *owning* the professional group using its tools.

In some circumstances, the market space can be defined around product characteristics, which can lead to further segmentation. **Ricola**, producer of herbal candy, defined its market around taste, as well as packaging features.

¹Adapted from Felco company profile.

²Ibid.

The **Ricola** assortment remained focused on its core herbal candy business segment. It consisted of two types: sugar and sugar free (sweetened with Stevia or artificially sweetened). The company offered some 25 different tastes but not all were sold in all markets. Aside from taste segmentation, Ricola offered its products in a wide variety of packaging alternatives that substantially added to the number of 300 to 400 Stock keeping units (SKUs) offered.³

Subsegments to Define Target Customers

In the previous section about focus (Chap. 10), **Jura** served as an example of a company whose management changed its focus from being a full-line builder of small electric home appliances to a supplier of espresso machines for home use exclusively. The change of its focus did not stop there. A very specific segment was further targeted, in order for the company to distinguish itself from competing espresso machine makers.

Jura focused on fully automated in-home coffee machines from ground coffee only, i.e. the bean-to-cup types. Other competitors, including SAECO, de Longhi, Krups and Nivona, all of them larger than Jura, also offered capsule-based machines; some were into small home appliances beyond coffee. When it came to the specific application segment, Jura focused strictly on the in-home-use segment and consistently stayed away from institutional markets, such as hospitals, restaurants, offices or canteens. More recently, some expansion has been observed into the area of small and selective office types, such as offices of law firms. Within its home segment, the focus was on the top segment. Jura aspired to offer exclusively the most demanding machines and left the low-priced machine segment to competitors. Jura was the only player in this field that operated such a clearly articulated segment strategy.⁴

Jura's segmentation experience demonstrates that a focus strategy alone does not eliminate the need for further segmenting the market in order to guide the effort to very specific customer segments. Although Jura is a company smaller than many of its larger, international competitors, it is the largest in its chosen segment. All of its marketing and sales activities are centered on its chosen segment. Absolute size of sales alone is not critical; the relative size in a chosen segment can determine market success.

Redefining its market space was also a factor at **Pilatus** which followed a unique approach to the areas of general aviation and pilot training aircraft. The company pursued two segments (government and general aviation), grew them over time, and connected the two via related technologies.

Government Aviation was **Pilatus'** initial segment and historically its largest one. This segment comprised its military training models, such as PC-7 MkII, PC-9 M and PC-21 military pilot trainers as well as complete support systems and simulators. The company claimed global leadership in this specific sector. Accounting for about 35 percent of sales,

³Adapted from Ricola company profile.

⁴Adapted from Jura company profile.

deliveries to this sector were characterized by a different sales and decision-making structure. After some tests on an improved version of the PC-7, Pilatus embarked on the formal development of a new generation of training aircraft to replace both ageing generations of PC-7 fleets and the PC-9 models. Named PC-21, the first models were delivered in 2008. The PC-21 was intended as a new generation of flight trainer, allowing military pilots to do much of their training on a single trainer and move directly into fighter jets. This resulted in substantial cost savings as the flying conditions of a military jet could be experienced on the PC-21. For this to work, the cockpit layout of the plane allowed for the installation of advanced avionic configurations similar to those experienced in advanced military aircraft.⁵

The Pilatus approach to the military training market was unique. Where, initially, there were several segments, each comprised of ever more sophisticated aircraft, the company collapsed the three or four separate segments into a single one, developing a model that combined the functions spread over several previously separate segments. The market turned out to be oversegmented and presented an opportunity to agglomerate them into a single segment with substantial benefits for the government users.

Pilatus took a segmentation path that was completely opposite to that of the general aviation market. The company management realized that in between its main segment of supplying turboprop-powered single-engine aircraft, piloted by owner-operators, and the next level up, twin-jet executive aircraft, piloted by professionally licensed pilots, a significant market gap existed that could be exploited if the main aircraft characteristics of both existing segments could be combined, creating a new, third segment, in between.

Pilatus General Aviation segment included sales to the civil sector and comprised the large programs around the PC-12 turboprop single engine executive aircraft, with more than 1,700 planes delivered since 1994. The commercial and operational success of the PC-12 cemented Pilatus' reputation as a builder of general aviation aircraft. In feedback solicited from users for ideas for a next generation model, pilots requested more speed and range while keeping the rugged landing strip performance. Thus, Pilatus began development work in 2007 on a new model that was to result in the PC-24, a twin-engine small executive jet that retained much of the PC-12 turboprop performance. Powered by two rear-mounted jet engines and seating up to ten passengers, the cockpit was laid out for two pilots. However, the advanced cockpit configuration reduced pilot workload allowing for single pilot certification. The PC-24 was the first business jet equipped with a sizeable cargo door. Designed to operate from both short and unpaved airstrips, the PC-24 came equipped with landing gear to smooth out uneven surfaces and wheels to prevent sinking in on soft surfaces.⁶

The immediate resulting success in selling out the company's aircraft building capacity in record time signaled that spotting this new segment had been an excellent strategy.

⁵Adapted from Pilatus company profile.

⁶Ibid.

Playing the Product Features Game

Two companies offer a view on how to play the product feature game once a general technology focus has been adopted. Both **Rüeger** and **Sylvac** concentrated on two different sectors of the measurement business. Having found that products could be used in a myriad of industrial and artisanal applications, both companies pursued a strategy of occupying the space with a large number of product variations and features.

Rüeger, offering a full range of temperature measuring instruments, expanded considerably beyond its original temperature gauges. To the bimetallic temperature gages gas thermometers, HVAC temperature gauges, thermometers for marine diesel applications and thermowells. More complex, further products included temperature probes with transmitters or multipoint sensors for use in many types of reactors. Temperature gauges represented more than 80 percent of company sales. Related to temperature instruments was a line of pressure gauges. And finally, the company also produced instruments on an OEM basis used mostly in the food industry. All of those products leveraged Rüeger's core technology around temperature gauges. In its application space, Rüeger offered one of the most extensive and differentiated product lines.⁷

Sylvac, originally starting out with hand-held tools for measuring, had steadily innovated beyond calipers. Digital indicators were added, and the product line included micrometers, internal measurement instruments, measuring benches and height gauges. More recently, Sylvac pioneered the area of connected metrology offering Bluetooth connections for its tools. Scanners for optical measurement, ranging from vertical to horizontal and equipped with zooming, was a first step into the instrument or equipment segment with considerably higher price points. Sylvac developed its own software and electronics to go with all its tools and instruments.

Both **Rüeger** and **Sylvac** maintained extensive catalogs containing a large number of standard products. The Sylvac electronic product line alone covered some 300 pages of materials and specifications. Clearly, these companies practice the cramming game discussed earlier, competing on a maximum number of product variations. Invariably, playing this game leads to a complex supply chain and small batch production volumes.

Targeting Multiple Segments

As companies move their market coverage beyond a single segment, complexities increase. The move into multiple market segments need not be accomplished at once but might arise from business developments, or reactions to changing market conditions. **Plumettaz** is a case in point where the leading segments changed over times, and yet there was always a dominating segment supported by the company's core technology.

⁷Adapted from Rüeger company profile.

Over its close to 100-year history, **Plumettaz** experienced significant shifts in the composition of its sales, all stemming from responses to opportunities in new market segments. Starting out in the food industry with packaging and labeling, the company moved heavily into the wine growing industry developing new equipment and pioneering the capstan-type winches. Learning how to mount winches on tractors, jeeps, or other vehicles, Plumettaz compensated the decline in the wine-growing segment with new equipment for lifting or pulling for non-agricultural applications. As the fiber optics opportunity developed, Plumettaz responded again and innovated beyond its core to develop cable-jetting skills. In 2018, Plumettaz sales to the Telecom industry amounted to about 60 percent, the other industrial applications accounted for about 25 percent of total sales.⁸

In the discussion of focus strategies, it was pointed out that firms who were able to leverage a single technology with multiple applications were well positioned to enter multiple segments. Such strategies were particularly successful when the additional cost of adding another application segment did not present a major hurdle.

At **u-blox**, it was soon found that the company's technology of embedding positioning and wireless communication into semiconductors for applications around GPS systems had great potential in many other sectors, both industrial and consumer. Confronted with such a *crisis of opportunity* at the company, a strategy had to be developed about how to go about the selection process in order to guide its business and set limits to prevent overextension.

The focus of **u-blox** was the segments of industrial, automotive and consumer applications. The industrial segment, about 55 percent of sales, included a wide range of applications, from fleet tracking, to cargo monitoring, street lighting, and to medical devices, based upon the company's 4G and 5G cellular systems-based modules. With the Internet of Things (IoT) appearing, volume in this segment was increasingly driven by this new megatrend. The automotive segment accounted for about 30 percent of company sales. The increasing technical requirements for Cm-level-precision positioning and secure Vehicle-to-Everything Communication needs were driving this sector where u-blox was a leader in bringing new generations of products to market. Electric vehicles and autonomous driving were also dominant growth factors.

The consumer segment, accounting for about 10 percent of sales, was driven by an increasing demand for smart technology in sport and fitness equipment, people and pet trackers, action cameras and robotic lawnmowers, as well as consumer drones. Concerning the selection of applications and customer requests, the company needed a minimum of units per year to bring a new application on stream. As a result, u-blox did not focus on small unit applications.⁹

The challenge of making selection decisions around a company's *crisis of opportunity* such as chasing more segments than might be good for the business did not only occur at **u-blox**. Other firms, **maxon**, **LEM**, or **EAO**, for example, all faced similar issues.

⁸Adapted from Plumettaz company profile.

⁹Adapted from u-blox company profile.

In the case of **Sefar**, it was a technology change in manufacturing, allowing the company to move from silk fabric to synthetic fibers, moving it beyond flour sieving, traditionally its major segment.

In the 1960s, synthetic fibers began to replace silk until finally, in 1990, the production of silk bag cloth was discontinued. It is possible to apply various chemical coatings on synthetic fibers, which meant that refinement was added as a new production step. The fields of application for **Sefar** fabrics became ever wider. Synthetic fibers, being superior to metal filters, allowed for filtration applications in the automotive industry. After great efforts, Sefar managed to make this area one of its most important business segments in the 21st Century.¹⁰

For Sefar, the target industries included the chemical, minerals, food, environmental, life science and machinery and equipment industries. The applications, or tasks to be performed, increased in step with an ever-growing number of different materials. How an expansion into multiple segments impacts on the marketing and sales processes will be discussed in subsequent chapters.

Market vs. Technology Segments

Bachem, producer of peptides used in chemical and pharmaceutical research, served two major user segments, namely the research segment and the good manufacturing practices (GMP) segment, intended for use in pharmaceutical products. Although the two segments operated under different rules, the company could still leverage its technology across both.

For the research segment, **Bachem**'s original market entry, no GMP specifications were required since these products were not for human consumption. This was a catalog business organized around basic building blocks. The peptides ordered for research could also be client specific. Main customers were university and pharmaceutical research departments. Business was conducted through a catalog and the product line topped 6,500 items.

The GMP segment, or pharmaceutical products segment, accounted for about 90 percent of Bachem sales. These peptides were intended for medication for humans. They could be used in clinical studies, either for phase I, II or III. Once specified for a trial, sales are stable. The product was owned by the pharma client and typically was custom-made. Sales were made under supply agreements, a forecast made by the purchasing customer, and included supply chain management commitments. Growth in this sector was directly dependent on pharmaceutical and biotech companies' research activities and clinical trials for new products.¹¹

Technologically, the market for peptides was divided into synthetic peptides and biologically derived peptides. **Bachem** was traditionally a synthetic peptide

¹⁰Adapted from Sefar company profile.

¹¹Adapted from Bachem company profile.

producer. With its business growing, Bachem attempted to enter the market for biologically based peptides given the similarity and overlap of its customers.

The market for peptides was divided into two major users, as well as two technology segments. At one time **Bachem** tried to enter the biologically based sector but had failed and was now limiting itself to synthetic peptides only. There were significantly different manufacturing processes between the two areas, with biologically derived peptides dominated by companies such as Novo of Denmark. The same limitations applied to the entry into the synthetic field by biologically based companies, such as Lonza, who unsuccessfully tried to enter the synthetic sector. The result was essentially two classes of competitors who did not directly compete with each other.¹²

The experience of Bachem, and other players in the peptide industry, demonstrates the limitations of segment expansion. As documented by other multiple segment firms, the requirement for success was closely linked to the exploitation of a common technology. Even when the customer base was the same, the players could not leverage successfully across technology boundaries.

Selecting Quality and Premium Price Segments

Most markets are characterized by some form of price or quality segmentation. Typically, the lower price segments yield higher volumes, but require a more cost-competitive supplier. Many of the Swiss SMEs are not cost leaders and attempt to make up for their cost disadvantage through moving into the top-quality and premium price segments. When doing so, it will be necessary to demonstrate, or support, quality claims with relevant information. The challenge then becomes how to operationalize the quality differential such that the price differential is more than compensated for. **Caran d'Ache** offered an example how to achieve this:

With its prices about 20 to 25 percent above major competitors, **Caran d'Ache** was challenged to justify its price premium in terms of superior quality. Only perfection in its products allowed it to render a lifetime guarantee for its writing instruments. The company combined sustainability processes with superior quality and was able to claim superior quality along a number of dimensions. Its built-in 'airbags' worked as shock absorbers when pencils are dropped. Single pencils could be ordered to refill its boxes and the pencils boxes themselves could be reused for other purposes. The company used twice as much gold as its competitors to plate and emboss its pens, as well as offering repairs or refills. All of these elements contributed to lowering the lifetime cost to the user while adding superior functionality and durability.¹³

The optical component supplier **Mikrop** deliberately chose to pursue a premium quality and specifications segmentation, staying away, on purpose, from the lower-quality, albeit high-volume, segments, which were crowded with many competitors.

¹²Ibid.

¹³Adapted from Caran d'Ache company profile.

Soon after its launch in 1981, **Mikrop** quickly positioned itself as one of the leading providers of specialized micro-optics for industrial image processing and medical technology applications. Mikrop focused on high-end optics with a diameter between 0.3mm and 15mm and was widely regarded as a top-quality manufacturer in the industry, where only a handful of companies worldwide could offer micro lenses of matching quality. This systematic focus on a global niche proved to be the right strategy. Mikrop realized that the company's strength was in optics of very small diameters and also realized early on that it did not make sense to go into other, less specialized segments with fierce competition. The company focused on high quality products paving the path to a position as one of the most sophisticated suppliers of high-precision optics globally. Due to the relatively small size of Mikrop's niche, bigger players were reluctant to enter its market.¹⁴

Key to a successful niche strategy is its relatively small size, rendering it unattractive to larger players. By concentrating on the small niche, and by delivering a full product line to service to that segment, the niche player can always outdo the generalist by offering products in every possible variation.

Moving into High-Volume Segments

Pursuing high-end segments, both in terms of quality and function, worked for most of the SMEs covered in this research. There were, however, also exceptions, such as **Burckhardt Compression**'s successful strategy of demonstrates. The company found itself competing mostly in a small segment, leaving the majority segment to larger international competitors.

The global installed base of high-performance compressors was estimated at about 75,000 installations. **Burckhardt**'s installed base amounted to about 5,500 operating compressors, made up of 300 hyper compressors of the highest performance in terms of pressure, as well as about 4,700 labyrinth compressors and 500 process gas compressors, all made by the company itself. In addition, some 70,000 process gas compressors were in use worldwide made by competitors, mostly large international firms.

Burckhardt did not really compete in the process gas compressor market. CEO Vogt convinced his team to move into this lower segment that was very large and could be considered a must win segment for Burckhardt. Entering this segment meant selling to for Burckhardt novel user segments, the Oil & Gas, refinery and chemical sectors. Burckhardt could leverage its oil-free technology and vibration-reducing models where the company possessed a unique advantage.¹⁵

Burckhardt Compression entered the higher-volume gas process compressor market with the technology of its top-of-the-line high-performance machines. This way the company avoided building a lower-quality piece of equipment, steering clear of a trading down strategy. The move turned out to be highly successful and contributed substantially to later growth.

¹⁴Adapted from Mikrop company profile.

¹⁵Adapted from Burckhardt Compression company profile.

Niche-Within-Niche Segments

DC Swiss, a specialist tool manufacturer located in the Jura region, epitomizes the execution of a niche strategy that is so delineated and chiseled, that it qualifies for the *niche-within-a-niche*, or *focus-within-focus* description. The company specializes in threading technology. Threading was a manufacturing process; threading tools were used to create screw threads. Compared to other manufacturing processes, such as milling or turning, threading was more complex.

Throughout its history, **DC Swiss** remained focused on threading technology and the tools needed to produce high quality threads for demanding applications. Threading tools were a niche in a much larger space of all kinds of cutting, machining, grinding, drilling, reaming, and milling tools. DC Swiss competed with a number of larger companies and was the only Swiss company focused exclusively on threading. Competitors were larger, but often carried a more limited number of threading tools. Threading technology competitors existed in Germany and Italy, a few specialists operated in Japan, but no direct competitors came from the US. There were also some broad-based global tool manufacturers, that did not specialize in threading and carried basic threading tools only.¹⁶

With a sales volume of less than CHF 30 million focused entirely on the threading segment of the large, global, tool market, further subsegmenting would seem to be unnecessary. However, the company embarked on a segmentation with even more granularity to provide more focus to its operation.

DC Swiss adopted a strategy of *focus-within-focus* by dividing its business into two parts. **DC Thread** was the unit tasked with pursuing standard applications for standard sized threads of 3 mm and larger, including some MEGA applications of up to 160 mm. Part of the product portfolio of this unit were a complete range of taps, roll taps, thread mills and thread whirls for the full range of materials from stainless steel to composites. The company offered several thousand different products in this segment.¹⁷

DC Nano was the new unit tasked with pursuing threading technology for sizes of 0,3 mm to 3 mm. These smaller diameter threads were viewed as contributing more value-added, resulting in better margins for the company and safer from copying by competitors. DC Nano could offer the full range of tools, such as thread cutting, thread forming, thread whirling, plug gauges and thread ring gauges, including soft rigid tapping and tapping chucks, all focused on the small diameter segment. DC Nano had a product portfolio of several hundred items. These tools were sought after by watchmaking, aerospace, optical, automotive, energy and medical sectors.¹⁸

The **DC Swiss** strategy of taking a subsegment and concentrating even more on the nano-sized segment by moving to where few competitors were willing to follow meant developing an expanded product line of several hundred specialty tools.

¹⁶Adapted from DC Swiss company profile.

¹⁷Ibid.

¹⁸Ibid.

Added to the thousands of tools from its standard segment, the company is an example of the *cramming the market space* strategy that makes it very hard for larger competitors to follow. The dual approach was made possible through the common manufacturing and technology strategy serving both segments.

An astute reader will probably raise the question of critical mass, whether a company did not need to be of a certain size to compete. The question may have to be posed differently: Is it critical mass per company or is it per segment? Although one of the smaller tool companies competing worldwide, DC Swiss had *giant status* when it came to the threading segment; it had even more so when looking at its product line relation to others in the nano-threading tool segment.

Organizing Around Segment Choices

The previously cited example of DC Swiss makes clear that if several segments were served, dedicated organizational units could provide traction to the focus strategy. Breaking out DC Nano from DC Thread within DC Swiss allowed for the yet smaller but new product line to be given sufficient internal attention in order to grow and not to get pushed aside by concerns of the dominant segment.

This close connection between focus, segment selection, and company organization could also be observed at **LEM**.

Although **LEM** was focused on selling components, or transducers, only, the company had built up over time a wide range of industry sectors where company or product specific components were sold. Railroad and track side applications were the first segments penetrated. Later on, industrial applications, such as for robots, for energy and automation, eclipsed the rail sector. More recently, the automotive sector was gaining in importance. In response to this development into multiple segments LEM reorganized itself by separating the automotive component business from other industry applications. Although initially accounting for only about CHF 5 mio in sales, the segment grew faster than other parts of the business and reached CHF 50 mio by 2018, accounting for about 20 percent of LEM sales.¹⁹

The experience at **LEM**, **DC Swiss**, and other companies suggests that focus or market segment selection strategies alone will not be fully successful unless followed-up with organizational changes that provide sufficient attention to emerging segments.

Observations on Segmenting

This section moved from focus, or market space selection, to segmenting the space and, eventually, picking specific segments for targeting. It is important to understand that focusing on a market space (e.g., industry, market, technology, customer

¹⁹Adapted from LEM company profile.

franchise, or solution) alone is not sufficient, but an SME also needs to further narrow its range of activities on a few coherent market segments.

Companies may employ creative ways of defining their chosen market space and its dimension for segmentation. Such creativity, or market vision, helps in defining specific segments for action. Insights for segmentation stem from a unique definition of the market space dimensions. To the extent that a company may have adopted a nonstandard way of defining the market space dimension, a company can earn a competitive advantage. Multiple segments may be selected as long as they stem from the same market space, otherwise dilution of effort may occur.

SMEs gain from narrow definitions of the chosen segment, or segments, when they follow-up with a market-cramming approach, filling their chosen segment with a large number of product variations, or models. By dint of such a strategy with a more dedicated, more refined offer, the SMEs can outperform their larger competitors that do not specialize within the selected segments. In this David vs. Goliath battle, SMEs can achieve higher market share and sustain their market position in the chosen segment. Reversing the tables, David actually becomes Goliath.

Open Access This chapter is licensed under the terms of the Creative Commons Attribution 4.0 International License (<http://creativecommons.org/licenses/by/4.0/>), which permits use, sharing, adaptation, distribution and reproduction in any medium or format, as long as you give appropriate credit to the original author(s) and the source, provide a link to the Creative Commons license and indicate if changes were made.

The images or other third party material in this chapter are included in the chapter's Creative Commons license, unless indicated otherwise in a credit line to the material. If material is not included in the chapter's Creative Commons license and your intended use is not permitted by statutory regulation or exceeds the permitted use, you will need to obtain permission directly from the copyright holder.





Although all companies researched in this study show extensive international market involvement, the strategies, as well as patterns of involvement, differ substantially. These differences relate to the geographies of the company's first exports, as well as the legal forms that were adopted, ranging from agents and distributors to wholly owned subsidiaries. As shall be addressed, some of these differences have to do with the firms' size and resources.

There are, however, some general patterns common to most of the sample companies. First and foremost, all the firms began their exporting operations early on in their development. Second, a key role was played by the company founders who traveled extensively to develop their businesses.

The development of some of the older firms was often impeded by wars and considerable fluctuations in currency values. Although these events impacted larger firms too, their relative impact on the smaller SMEs was more pronounced and required considerable managerial and entrepreneurial ingenuity to overcome.

Early Pioneers of International Expansion

Sefar's founder Pierre Dufour, who started the firm in 1833, making it the oldest firm in the research sample, undertook his first business trip to the USA just 2 years later.

As early as 1835, Pierre A. Dufour made his first business trip to the United States and succeeded in winning customers there. At that time, a trip to America could still be described as a real adventure. The crossing by ship took almost thirty days and was not without danger. In 1839, Dufour made his second trip to the US. Because the demand for silk bag cloth was greatest in industrialized countries where large, modern mills operated, the US became an important market. At the end of the 19th Century, half of the production of Swiss silk gauze

went to the US. Swiss silk gauze was more expensive than that from other countries but of superior quality due to a special weaving technique and experienced weavers.¹

Although these documented early trips of Dufour were to the USA, it can be assumed that he also traveled within Europe for business. As the company grew, and since international customers accounted for the largest part of its sales, management undertook the next big step and created a more permanent presence in the USA, followed by other operations in France.

In 1900, Dufour & Co. founded its first subsidiary in New York. When the French producers of silk gauzes began to threaten the Swiss with their cheaper products, the Schweiz. Seidengauzefabrik AG Thal, in consultation with the its Zurich sister company, went on the offensive. In 1911, it established a weaving plant in Panissières, France, headed by Hermann Tobler. Later, other rival companies were bought out. In 1929, the subsidiaries of SST and SSZ in the North American market merged into a stock company under the name Tobler, Ernst & Traber, Inc. Because of the reliance on imports and exports, both World Wars hit the company hard, but it managed to recover both times.²

The international expansion of **Felchlin** was partially affected by its traveling owner, although these developments did not always take the form of a deliberate strategy.

Entry into Japan came about in an ad-hoc manner. As part of his extensive travels, Max **Felchlin**, Jr., visited Japan in the 1970s. Given his talent for writing, he authored articles in the *Neue Zürcher Zeitung* (NZZ) about Japanese food and nutrition. Siber Hegner, a large Swiss exporting company with a major presence in Japan, at that time was looking for a hazelnut bakery filling to sell in Japan, so Felchlin was contacted and business developed. A Felchlin Club was established where Japanese traditional confiseurs could learn about Western style confiserie. As a result, Felchlin was present very early during the rise of the Japanese confiserie and pastry scene that today had eclipsed those of Europe and France and was now recognized as leading worldwide.³

Felchlin's entry into the US market came about as a result of a contact from a potential US customer with the firm and was unrelated to Max Felchlin Jr.'s extensive travels to the USA.

Bakery fillings, **Felchlin's** main product for decades, were hard to export as moisture problems posed packaging challenges. As it turned out, "the US came to Felchlin": A young chef acquainted with many Swiss and Europe-trained chefs in the US, let the company know that "we could sell European raw materials to the US market." An importer was appointed and, step by step, the business expanded.⁴

¹Adapted from Sefar company profile.

²Ibid.

³Adapted from Max Felchlin company profile.

⁴Ibid.

Entrepreneurs at other companies were also actively engaged in opening up markets, first in Europe and later overseas. Most of their trips took place after WWII and were often undertaken by car. Fernand **Plumettaz** traveled extensively to France to visit wine growers and campaign for his “Plumett” branded equipment. At **Ricola**, founder Emil Richterich, and later his son Hans-Peter, made frequent trips abroad to visit trade fairs and recruit potential distribution partners. At **Felco**, founder Felix Flisch personally traveled to agricultural centers in France, Germany, and the Benelux countries to demonstrate his tools.

Another pioneer traveling personally was Urs Baumann who took over **Lantal** from his father in 1964. With a passion for the aviation industry, he restructured the weaving company with special attention to the US market.

With limited knowledge of English, he went to the US and, in 1972, opened two sales offices there. Then, in 1979, the company made the courageous decision to open its own factory in Rural Hall, North Carolina, which produced mainly for the American market. North Carolina has always been most famous for textiles because most of the textile companies are located there. The subsidiary in the US was an independent operation but was still strongly embedded in the corporate strategy. The internationalization of the company called for an internationally comprehensible name and therefore the weaving mill became Lantal Textiles in 1996.⁵

These, and other, stories of the sample companies demonstrate that international expansion was taken very seriously and was deserving of personal attention by the company founders. Company leaders made a point to be personally present at international trade fairs and to meet with customers abroad, and it was their personal commitments that drove the international expansion of their firms. Once initial contacts were established, formal distribution networks had to be built and maintained.

Relying on Distributors and Agent Networks

It was primarily the smaller firms who relied on agents or distributors to cover their respective markets. Too small to justify sales subsidiaries, the smaller SMEs built far-reaching networks consisting of dozens of agents who also carried other, and at times competing, products to the target markets. The experiences of four smaller companies (**Rüeger**, **DC Swiss**, **Sylvac**, **Plumettaz**), all in the CHF 25 to CHF 40 million sales range, were selected to illustrate this type of distribution strategies.

Rüeger, focusing on temperature measurements in mostly industrial processes, covered the world market, except for the USA, through a network of independent agents appointed for individual markets or countries.

About 60 independent agents located in many different countries supported this sales effort. Typically, the agent handled the selling, **Rüeger** quoted prices for the agent who sold and

⁵Adapted from Lantal company profile.

delivered the instruments to the customer. In the company's experience, the quality of its agent network was uneven, with only about a third earning the label excellent. Geographically, more than 80 percent of Rüeiger sales were destined for the export market. Europe accounted for about 40 to 50 percent of sales, and Asia about 35 percent. Rüeiger was not active on the US market due to different technical specifications.⁶

DC Swiss, focusing on the narrow segment of threading tools, was also using independent distributors as the backbone of its international distribution effort. However, the company augmented the agent network with a subsidiary in one key market, a logistics center for the EU, and a franchise operation in another key market. Due to its small size, it entered a collaboration with another Swiss company to serve the Chinese market.

Given the limited market opportunity of the Swiss market, **DC Swiss** was early in the export business. Currently, about two thirds of sales were exported. The company built up about 30 exclusive distributors, appointed per country, with some being responsible for more than one country, in total covering more than 50 countries. About 65 percent of company sales went through its distributor network, the rest direct to end users.

To strengthen its market coverage and logistics support, the company created a subsidiary in Cologne, Germany, to handle logistics to EU countries. The distribution operation in the UK was structured as a franchise. In Italy, an important market for threading tools, the company operated its own subsidiary. To help with expansion in China, DC Swiss entered into a collaboration with URMA, a Swiss producer of reaming tools, who had set up a company in China in 2008. Geographically, DC Swiss sales outside of Switzerland were largely focused on Europe, where more than 80 percent of its exports were shipped, with still smaller percentages to the rest of the world.⁷

Sylvac, focusing on both manual and digital measurement devices, utilized a mix of distribution channels that includes not only independent agents but also collaborations with other companies in similar circumstances. In addition, Sylvac engaged in extensive OEM arrangements for about half of its sales.

For distribution, **Sylvac** relied on an extensive global network of more than 60 independent agents covering most markets with substantial manufacturing industry clusters. A team of half a dozen technical sales representatives maintained connections to the agents. In two European markets, France and Germany, Sylvac collaborated with Trimos SA and owned part of the distribution operations. The China operation and OEM sales from there were fully owned by Sylvac. The vast majority of Sylvac sales were exported. European markets accounted for about half of sales, the US about 15 percent, Asia-Pacific about 20 percent and 15 percent were accounted for by many other smaller markets.⁸

⁶Adapted from Rüeiger company profile.

⁷Adapted from DC Swiss company profile.

⁸Adapted from Sylvac company profile.

Plumettaz, a manufacturer of cabling equipment, also maintained an extensive agent network but had augmented it by selective subsidiaries that also engaged in some production or assembly.

Global sales at **Plumettaz** were made through four international sales subsidiaries in the Netherlands, Singapore, China and, most recently, in the US. The company also maintained some 50 distributors across the world. A small number of international sales managers kept close contacts with key clients and supported agents from the company base in Switzerland.⁹

Maintaining global market coverage through agents was generally viewed as challenging. The quality of the agent networks was not uniformly high, and control over the distribution channel was less effective than it would be with a network of wholly owned subsidiaries. Despite these difficulties, it is nevertheless impressive how small firms with limited resources can deploy globally. None of these companies would have survived if they had not extended their geographic coverage given that they were focused on very narrow market niches.

Agent or independent distributor networks were not only the choice for smaller companies, but also common among companies starting out and, in some cases, remained the main sales network even after the company had grown. **Caran d'Ache**, producers of fine writing instruments, which are distributed globally, exemplifies a company that has adhered to its traditional network over a long period of time.

At **Caran d'Ache** distribution in international markets was made through a few selective subsidiaries in Japan, Germany and France. The vast majority of the 90 markets were served through independent distributors. Some of these distributors had been working with Caran d'Ache for generations and were selected and appointed partly on the basis of their fit with the Caran d'Ache philosophy. Shipments were made from the Swiss base within 48 hours of order and all invoicing took place in Swiss Francs. To build more sales abroad, the company engaged in shop-in-shop sales, as well as in duty free zones at airports. In China, the company collaborated with a partner around an art center concept.¹⁰

Building Distribution Partnerships

The task of finding and appointing suitable distributors or agents takes time. Some companies have tried to use partnerships as a means to arrive at quick market coverage. This process invariably requires relying on other, larger firms, who can cover multiple markets and thus offer instant distribution to an SME. As we can see from the examples of **Medartis** and **LNS**, the OEM distribution arrangement can lead to conflicts of interest between the exporting SME and the OEM companies that are expected to provide the sales arm.

⁹Adapted from Plumettaz company profile.

¹⁰Adapted from Caran d'Ache company profile.

When **Medartis** first went to market (in 1997), the company tried to leverage its connections to the Straumann Dental company using the Straumann distribution system. Medartis quickly realized that this did not work and began to build its own distribution system based on sales subsidiaries and distributors not related to Straumann Dental. International expansion began in 2002 with the opening of sales offices in Germany, Austria and France. A number of sales subsidiaries followed in the UK (2003), the US (2004), Mexico and Poland (2008), as well as in Australia and Spain (2010). The most recent sales subsidiaries were formed in 2018 through the acquisition of a local distributor in Brazil and a new operation in Japan. In addition to its 11 sales subsidiaries employing about half of Medartis staff, Medartis products were also sold in 40 countries through 35 distribution partners, collectively accounting for about 15 percent of sales.¹¹

Medartis needed access to orthopedic surgeons and was not well served by the Straumann Dental distribution network which was geared toward dental surgeons. This experience demonstrates that the best distribution network needs to reach the exact and specific sales targets. No matter how willing, a partner who is not already serving those targets is not likely to provide a strong sales effort, because that partner would need to learn a different “language” and visit targets not already on its customary visiting lists.

That partnerships with OEMs visiting the required target companies are not a guarantee for success was experienced by **LNS**, manufacturer of bar feeding equipment.

LNS bar feeders were not stand-alone equipment. Instead, they were engineered to be plug-compatible with a range of OEM machine tool manufacturers, such as for lathes. *Leveraging* the connection, LNS first sold through the machine tool OEMs, making them sole agents. This did not work in France or in the US market as there was a conflict of interest between OEMs and equipment dealers. OEMs did not like the fact that LNS bar feeders would fit with any equipment, not just their own. While an OEM machining center might sell for CHF 250,000, a bar feeder sold on average for CHF 25,000. For dealers, on the other hand, these were peripherals, offering them extra income at even better profitability than selling OEM machines. Eventually, LNS switched its sales strategy to go directly to dealers, eliminating OEMs. To support sales into international markets, LNS began to create its own sales network to better control its markets. The entry into Japan was in 1978 and the US sales network was created in 1982. As international sales developed, a need for company branches arose, starting in 1984 in Los Angeles (US), followed by France and Italy in 1990, the UK (1992), Malaysia (1994) and Korea (1999).¹²

LNS demonstrates that a prime reason for moving to one’s own sales network was control over its sales effort. Control is maximized through a salesforce in the company’s employ. This is, of course, very difficult to reach for small firms which, at best, can employ regional managers who stay in touch with the distributor network, but this does not assure control down to the customer contact level.

Felco, the producer of agricultural cutting tools, leveraged a partnership with a large international firm to expand its own distribution coverage.

¹¹Adapted from Medartis company profile.

¹²Adapted from LNS company profile.

In 2014, **Felco** entered a wide-ranging partnership with Stihl of Germany, world leader in power saws and lawn care machinery. Stihl, who was into cutting big trees, wanted access to Felco technologies and products for the cutting of small trees and branches. Felco agreed to a partnership that offered important benefits for both companies. Stihl obtained access to Felco's various technologies on an OEM basis and, in return, Felco obtained access for its tools through Stihl's 40,000 points of sales, worldwide. The products marketed through Stihl were being co-branded but produced by Felco.¹³

As seen from the experience of companies starting out with either independent distributors or agent networks, or having relied on OEMs, the preferred channel in the end is a fully controlled network consisting of sales subsidiaries. The next section will explore how this was accomplished by some of the firms in the research sample.

Creating Subsidiary Networks

The histories of many SMEs in this book confirm that although starting out with agents, wholly owned subsidiaries came later, replacing independent distributors in key markets. This development took some time and companies with that construct tended to have sales above CHF 100 million. These companies were able to cover the world market, or their relevant part of it, deploying around a dozen sales subsidiaries in their key markets. In most instances, no more than 15 subsidiaries, based worldwide, sufficed in being present in 75–80% of the market a company served.

Ricola, the herbal candy producer, began to export in the early 1940s to Germany and France. Relying on international distributors at the early stage allowed Ricola to concentrate on production, leaving local distribution, marketing, and selling to external partners, one country at a time. The network included over 50 distribution partners worldwide.

Those distributors were important to **Ricola** because in the early growth phase of the firm production was a constant constraint. Relying on distribution partners who took responsibility for distribution in their countries, allowed Ricola to focus on its production bottleneck. In the 1960s, the major export markets were France and Germany. In those countries, and in Switzerland, Ricola became the market leader in its category. In the 1970s, Ricola initiated considerable marketing activities in Japan, Hongkong, Taiwan and Singapore. In 1980, the subsidiary Ricola US took up operations but the company had already been present in the American market since the 1960s. In China, Ricola's presence goes back about 30 years with a strong track record and its brand well-known there. Ricola was exporting 90 percent of its production and converted a number of local operations into subsidiaries, seven in total, mainly in the US, Germany, France, Italy, UK, Canada and Italy. Major changes also took place in the Chinese markets where the company changed its initial long-running export relationship with a Swiss-based trading company to deal directly with a Chinese partner. This resulted in a substantial expansion of its point-of-sale (POS) across all regions of China.¹⁴

¹³Adapted from Felco company profile.

¹⁴Adapted from Ricola company profile.

Jura Espresso Machines went through a similar transformation of its distribution network. As its marketing strategy, under the “House of Jura” brand, required that Jura coffee machines were not placed next to those of any other competitor, stricter control over its distribution network became a key element of the company’s strategy.

For **Jura**, the company did not want to be placed as one among 20 other coffee machine brands, just anywhere on a retailer’s shelf. To avoid this, the company engaged a strict control of the POS environment, from controlling dealer needs, controlling how customers were to be treated and teaching how to sell the Jura line. This focus, Jura believed, could only be achieved with a single line of espresso machines on display. Jura had thus reduced the number of selling points globally from 11,000 POS at one time to presently only about 7,000 POS. At the same time, efficiency per POS substantially increased. Global distribution was achieved by a combination of company-owned sales subsidiaries in key markets in Europe, North America and Asia, combined with national dealerships selling through retailers. Although distributor sales accounted for only about 30 percent of global Jura sales, this segment experienced the fastest growth.¹⁵

Even for a company such as **Jura**, a complete reliance on sales subsidiaries for all markets was not considered. With the economic development of some of the markets still being served by distributors, it was likely that some of those would eventually be converted into sales subsidiaries.

The strategies pursued by two electronic component companies, **LEM** and **u-blox**, who started to build their networks over the past 20 or 30 years, show that companies continue to employ a mix of distribution forms, combining company-owned distribution with agents or catalog businesses.

At **u-blox**, sales to OEM customers were in the hands of three crews with regional concentration on Europe, North America and Asia/Pacific. These teams could count on the support of 13 sales offices and about 50 distributors in key countries. The opening of international sales offices started early with u-blox opening US and Asia offices in 2001. In 2018, sales were about evenly divided between Asia/Pacific (35 percent), Europe/EMEA with 32 percent and the Americas with 32 percent.¹⁶

According to **LEM**’s business model, the company aimed at going direct to countries or markets, accumulating annual sales CHF 4 million or more. At that level, LEM was able to justify establishing a sales subsidiary. Below that threshold, the company was selling through distributors and catalogs. The need to be close to customers led to the establishment of more than 20 sales offices across the world.¹⁷

With sales ranging between CHF 300 million and CHF 400 million, both LEM and u-blox were in a much better position to field their own distribution and sales

¹⁵Adapted from Jura company profile.

¹⁶Adapted from u-blox company profile.

¹⁷Adapted from LEM company profile.

forces. The same was true for other companies in this research, for example, **Komax**, **maxon**, and **Oetiker**.

Market Entries Around Manufacturing Acquisitions

At some companies, the buildup of international distribution networks went hand in hand with the acquisition of foreign companies and their operations. Once a company with manufacturing operations abroad was acquired, the SME usually obtained market access, base sales, and distribution outposts around the newly acquired operation.

Two companies can serve as examples here—**Filtrox** and **Bachem**—which used an acquisition strategy to build, among other things, a sales network. The creation of production capacities will be discussed later when looking at the manufacturing footprint of the researched companies.

In 1984, Toni Rusch became managing director of **Filtrox**. His prior experience was in the chemical industry where he developed a strong international orientation. Filtrox was still relatively small. With exports important, Filtrox had only a single production site in Switzerland and no foreign subsidiaries. Rusch fostered the international expansion and, in the following years, whenever an opportunity arose, Filtrox took over smaller competitors and eventually become number two in the global market. In 1988, Filtrox acquired the UK company Carlson Filtration with around 60 employees. Carlson had a strong position in England and in the Commonwealth countries, where Filtrox had not been very active before. With a market share of over 50 percent, Filtrox became world leader in beer filtration. In 1998, Filtrox started a joint venture (JV) with a Czech company to produce filter sheets in Broumov, CZ. In 2001, it acquired another competitor, Papelera del Besos Placas Filtrantes S.L. in Barcelona, which had a good market position in Southern Europe. Finally, in 2013, it acquired the majority stake in Columbia Filter, in Mexico, to gain a better position in the North and South American markets.¹⁸

The **Filtrox** experience and development demonstrates how each acquisition, in the UK, the Czech Republic, Spain, and Mexico, provided market entry to specific regions or market segments and were the primary reasons to acquire these international firms.

Throughout its expansion, **Bachem** made several acquisitions that added to its global footprint. Most of the acquisitions were initiated by the companies approaching Bachem and offering themselves for sale, reflecting more of an opportunistic rather than a planned approach. Each piece of the puzzle was then integrated into the overall Bachem operation to expand its global sales footprint. Bachem began exporting early. Sales and marketing centers were first opened in Germany (1988) and in France (1993). The market entry into the US market had previously taken place with the opening of a subsidiary in Philadelphia. Up to that point, manufacturing had taken place only in Switzerland.

¹⁸Adapted from Filtrox company profile.

The first major acquisition came in 1996 when **Bachem** AG was able to acquire Bachem, Inc., located in Torrance, California. Bachem, Inc. was originally established in 1971 by Bachem's founder together with a local partner. The two separated over a business disagreement after one year, turning the US company into becoming Bachem AG's major global competitor. When the original partner wanted to sell, Bachem used the opportunity to acquire the entire operation in 1996 and integrate it into its own business, thus creating Bachem Americas, Inc. With the acquisition came also subsidiaries in Germany and in the UK. In 1999, Bachem was approached to acquire Peninsula Laboratories, also located in California. The company marketed different peptides, largely focused on immunology applications, which represented a new field for the company. After lack of success, Peninsula was prepared to sell and Bachem acted on this opportunity. Included in this acquisition was a subsidiary in the UK which was later integrated with the earlier operation acquired from Bachem, Inc., into a single Bachem (UK) Ltd. in St. Helens.

The series of acquisitions in the US during the period of 1997 to 1999 led to a realignment of marketing and sales operations in the United States with focus on two locations in California. Marketing and distribution operations for North America were managed through the Torrance unit. Sales to Japanese customers and to customers in China, Taiwan, Korea and other Asian countries were the responsibility of a unit recently (2018) opened in Japan. For some countries, Bachem signed distribution agreements with firms who stocked standard or catalog products.¹⁹

The positive experience with the integration of the acquired operations triggered a similar move in Europe where **Bachem**, in succession, first consolidated its UK units into a single operation and then moved the German operations from Heidelberg to Weil a.R. (on the Swiss/German border outside of Basel), while at the same time merging its French marketing operation into a single European distribution center in Weil. Marketing and sales responsibility for Europe, India, and the Near East remained in the company's head office location in Switzerland.

Cracking Difficult Markets

Many companies confirmed that entry into the Japanese market posed difficult challenges. It required perseverance and a special effort. **EAO**, who managed to establish its presence in the Japanese railroad market, gained an 80% market share for door opening push buttons as a result of custom solutions and an extremely high delivery responsiveness.²⁰

The example of **LNS** demonstrates that sometimes several attempts were necessary to successfully enter Japan. It required three attempts by LNS to successfully establish itself in the country.

Japan had long been an important market for **LNS**, but it took three attempts until LNS could finally establish a firm foothold. Japan was a market with a large number of installed CNC machines and lathes, all prospective 'customers' for bar feeders, served by local suppliers. In

¹⁹Adapted from Bachem company profile.

²⁰See EAO company profile.

its first attempt, LNS started by appointing a large Japanese trading company, specializing in all types of machine tools, as its agent. When results were disappointing, the Japanese agent suggested to form a JV. LNS founded Nippon LNS in 1991 as a JV, but results still disappointed in relation to the potential of the Japanese market. The breakthrough finally occurred in 2012 when LNS could acquire a Japanese company. Yoshida Tekko KK had been founded in 1981 and its owner wanted to retire. With more than 100 employees, the company specialized in producing chip collection and air filtration systems, two areas with a perfect strategic fit for LNS. Yoshida continued to serve its markets with its own systems, plus selling LNS bar feeders, which were sold to the same customer group. As an extra bonus, LNS was able to transfer Yoshida's advanced filtration systems to be produced in markets outside of Asia.²¹

A different route was chosen by **maxon**, which early in its development came to the attention of a major Japanese company. This contact, established at an industrial fair, eventually led to a key order that helped launch maxon in Japan.

At the 1970 Hannover Fair, **maxon** made contact with the Japanese firm Cannon which led to a visit by Cannon executives to the maxon operation in Switzerland. Long negotiations ensued and eventually Canon took out a license for maxon Motors which gave maxon an early entry into the Japanese market. In 1979, the relationship with Cannon resulted in a major order over CHF 8 mio for motors to be used in a tachometer instrument. The licensing agreement with Canon expired at the end of 1987 when maxon wished to market its products directly. The agreement had favored large volumes, whereas maxon preferred smaller volumes of specialized motors combined with a flexibility to react rapidly to changing customer requirements.²²

The US market also posed challenges for entry into some segments. **Acutronic**, one of the smaller companies in the research sample, needed to find a way to enter the US market, a *must-win* market for its product lines of simulators. In the end, only after Acutronic had established a formal base was it possible to participate in that key market.

Acutronic USA was founded in 1989 in Pittsburgh, PA. Because of the importance of the US Aerospace and Defense (A&D) industry, it was essential to be active in that market. However, due to US regulations regarding confidentiality in the A&D industry, the Swiss and US entities had always been separate from each other. Hence, development and construction existed at both locations and worked independently from each other. While these duplicate structures made no sense economically, they were necessary and meaningful from a political perspective. Acutronic USA was staffed only with US citizens, not even the Swiss flag was flown in front of the Pittsburgh office. Customers typically did not know that Acutronic USA was owned by a Swiss company and considered it a US business. Through the US entity, Acutronic was able to serve all the important customers within the US A&D industry.²³

²¹Adapted from LNS company profile.

²²Adapted from maxon company profile.

²³Adapted from Acutronic company profile.

Entering China also presented many firms with particular challenges. Two strategies, different in intent, can be discerned. One set of companies used China as a workbench to source products or materials. Those strategies will be further discussed in the section about Sourcing. A second set of strategies dealt with entering China as a market. Many companies have achieved significant market presence in China by establishing local sales offices. The experience of **Plaston** combines both challenges, China as a workbench and as a market.

When In 1994, Hilti, a major customer of **Plaston**, disclosed plans to establish a production facility in China, requiring Plaston cases to be produced there, the Plaston management decided to take up the challenge. Within a year, case production was installed in a local state-owned enterprise. However, operation at the newly established Plaston Zhanjiang Ltd did not proceed smoothly. Plaston faced numerous challenges in dealing with government regulations, power outages and staffing requirements set by the state-owned business. At times, it took ten people to produce a single case. After just three years, the decision was made to close Plaston Zhanjiang Ltd.

This first venture into the Chinese market cost Plaston dearly but it also provided the company with an invaluable experience. After this false start, Plaston did not give up its ambition to gain a foothold in China. A breakthrough came in 2004 with the construction of a wholly owned production facility in Jiaxing near Shanghai. The production manager of the Plaston factory in Widnau, Switzerland, moved to Jiaxing to become the new plant manager there.²⁴

Managing Changes in the Distribution Channel

Distribution channels can be subject to changes due to technology and competition. Even the best laid distribution schemes can become obsolete and will force companies to respond, regroup, and rebuild.

A case in point is **Fraisa**, manufacturer of metal cutting tools. Its sales and distribution were initially centered on Switzerland. Exports were handled through dealers and distributors who carried a large number of different tools in their assigned territories. Fraisa did not engage in any direct sales. These tool distributors, or agents, were all resellers of a full range of tools, including those of other manufacturers. All through the 1980s, Fraisa built up an extensive international network of resellers.

A first change in **Fraisa**'s distribution model was prompted by the bankruptcy of its dealer in Lyon, France. Fraisa, to avoid a loss of CHF 300,000, took over the Lyon dealer in 1984. With this first foreign subsidiary direct customer support was now provided in France. Then, at the beginning of the new century, the market for cutting tools had changed fundamentally compared to the 1990s. On the one hand, big distributors started to bring lower priced private label tools to the European and the US markets, mainly copies of other tools, but produced at significantly lower costs in Asia! On the other hand, real global companies were arising, partially by organic growth but to a large extent by acquisition, the biggest of them being the

²⁴Adapted from Plaston profile.

Swedish Sandvik group. Others included the SECO group and the German Walter Group. From then on it was no longer a business of millions but of billions instead.

Fraisa took another step in 1988 with the foundation of Fraisa Deutschland GmbH, taking over a small distribution company with an attached workshop for special tools and the re-sharpening of cutting tools. The Italian subsidiary was founded in 1992. As trade barriers started to be reduced and Fraisa European competitors started to enter Switzerland, expansion into European markets became a necessity. As a result, Fraisa found itself suddenly confronted with low-priced Asian products imported into its own customary markets and no entry barriers to contain this trend. With its reseller-model in danger, the company was looking to defend its business in ways that could not be easily copied by, or sourced from, Asian products. Sales of Fraisa tools now took place worldwide through multiple channels: the company-owned sales units in Switzerland (including Asia and South America), in Germany, Hungary, Italy, France (Benelux and Iberia), the US (North American region) and China (for China and Taiwan). In addition, sales and support services were rendered through a network of independent dealers across a large number of countries.²⁵

The Fraisa experience proves that unexpected developments can wreck the best laid distribution plans, forcing companies to jettison long-cherished arrangements and quickly open new channels. Failing to do so can clearly risk the business.

Reflections

The practices described in this chapter were not always of the SMEs' own choosing. While control over distribution channels allowed for close management of the messaging targeted at the customer, as the case for **Jura**, smaller companies (e.g., **DC Swiss**) were not in a position to do this because their sales per country, or market, were too low and did not cross the threshold to make such a control economically viable. Companies making tools, or consumables, that were widely dispersed across many different user industries, did not easily reach critical mass necessary for fielding country-specific and fully-owned distribution.

Companies with higher sales per country were able to articulate their own distribution and sales strategies, indicating that clear thresholds exist when a company-owned sales unit could be implemented (**LEM**). In contrast, those firms selling major equipment with higher sale amounts *per deal* were more likely to field direct sales (see **LNS** or **Pilatus**).

Also noticeable are the geographic patterns observed in the international expansion of the firms. While most companies expanded to other European countries first, there was a different pattern seen among older companies, who made their first overseas jump to North America (see **Sefar**), compared to companies founded more recently, which tended to favor Asia, and China in particular, for expansion at a relatively early stage in their development (**Sylvac**). This shift in prioritizing Asia over North America reflects the geopolitical and economic shift in the global economy over the past decades.

²⁵Adapted from the Fraisa company profile.

Open Access This chapter is licensed under the terms of the Creative Commons Attribution 4.0 International License (<http://creativecommons.org/licenses/by/4.0/>), which permits use, sharing, adaptation, distribution and reproduction in any medium or format, as long as you give appropriate credit to the original author(s) and the source, provide a link to the Creative Commons license and indicate if changes were made.

The images or other third party material in this chapter are included in the chapter's Creative Commons license, unless indicated otherwise in a credit line to the material. If material is not included in the chapter's Creative Commons license and your intended use is not permitted by statutory regulation or exceeds the permitted use, you will need to obtain permission directly from the copyright holder.



The Marketing vs. Sales Debate

Although marketing and sales are closely related to distribution, the topic of the previous chapter, these two activities have been separated here in order to give both disciplines, and how they have been pursued by the sample companies, the special attention they deserve. Despite the fact that sales are generally regarded as a subelement of marketing, in practice, many firms separate the two organizationally and treat them at equal levels. Additionally, in consumer-oriented companies, marketing occupies a special stature due to its brand-building role. In most business-to-business (B2B) companies, those selling to other companies, it is sales that take the lead. Among the 36 researched companies, only a few can be categorized as predominantly business-to-consumer (B2C), selling directly to consumers (**Jura**, **Caran d’Ache**, **Ricola**, **Kuhn Rikon**). On the topic of branding and marketing, most of the examples will feature these companies.

B2C SMEs Engaging in Global Brand Building

Practices among the B2C companies vary considerably depending on size. Companies with sales above CHF 300 million, such as **Jura** and **Ricola**, can engage more directly with consumers worldwide and mount truly global campaigns. On the other end of the spectrum are companies like **Kuhn Rikon** and **Caran d’Ache**, both of which engage in brand-building activities but also emphasize different tools. However, none of these companies compete solely on classical marketing brand building.

For Swiss SMEs, the concept of brand value was central to their competing. Consumer products, often not sufficiently protected by intellectual capital in the form of patents, faced imitators at every step, particularly if they were commercially successful.

Developing and nurturing a global brand can protect the company from imitation by low-cost competition; it also helps differentiate the firm and justify the higher price inherent with products produced mainly by the high-cost Swiss base. Such a brand defense strategy was employed globally by Jura marketing its espresso machines.

Jura espresso machines were subject to imitation and copying, and Jura believed that a strong brand was much more difficult to copy. Around its product line focused on the best coffee, most attractive design and ease of use, the company built what it called “The House of Jura”, combining a strong brand, controlled distribution and outstanding service on its machines. Since 2006, Jura has collaborated with the Swiss tennis star Roger Federer as the main spokesperson for the brand. Jura saw a strong brand image as security for its customers that the product would live up to expectations. Jura’s worldwide identity helped to strengthen the brand wherever customers travelled, be it for business or for leisure activities. The global identity was not created for the sake of standardization but rather to signal consistent quality and to facilitate customer perception of the Jura brand.¹

Ricola also emphasized and articulated its brand values. Similar to Jura, where its spokesperson Roger Federer allowed for a connection to Swiss quality and Switzerland, Ricola included *Swissness* as part of its own brand value.

Ricola’s brand values were focused on the consumer. The company summarized them as functionality (good for your throat), enjoyment (in terms of good taste, not as a medication) and *Swissness* for its heritage. These three values were essential for the Ricola brand expression and if any given product did not contain those three, it could not be a Ricola branded product.

Organizationally, Ricola had moved over time from having its distribution partners play a major role in supporting the brand locally, to centralizing this task, a process that had already progressed very far at Jura. The recent emergence of social media also strengthened the drive toward centralization while making this tool a critical element in promoting the Ricola brand.

Maintaining the core values at Ricola was the responsibility of brand management. Originally, the company had relied more on its distribution partners in the countries to position the brand locally. Over the past years, brand management became an increasingly centralized task to avoid different interpretations of the Ricola brand by different partners, and to make more global brand marketing campaigns possible. A special role was played by social media, with Ricola market research engaging consumers on a daily basis to take the market pulse. In fact, until 2005, the company had little direct contact with consumers. The arrival of social media changed all that. The Ricola brand values were very much focused on the consumer and social media would signal to the company if changes were taking shape. Ricola would then adapt its product assortment.²

¹Adapted from Jura company profile.

²Adapted from Ricola company profile.

The impact of social networks and the Internet also caused **Caran d’Ache** to change its marketing and brand-building strategy. With a long tradition of marketing its products globally through independent distributors, the emergence of online sales as an important tool offered a new, more central, role to the company’s marketing operation. Another important element was the development of concept stores, and the first one was opened in Geneva, where company employees could have direct customer contacts and provide feedback to the central marketing staff.

Caran d’Ache invested about 10 percent of sales in marketing activities. The company believed that 80 percent of the population would search for products and product information online and then go to a store. The company opened its own e-shop on the internet.

The most recent development was building concept stores. The company came to the conclusion that its own retail store was needed in Geneva, as much for marketing as to understand the retail environment by engaging directly with customers. Feedback meetings were held on a monthly basis between retail and marketing staffs. The Geneva store was run by Caran d’Ache employees. Other concept stores were franchised with partners in Berlin and Tokyo.³

With a traditional distributor network in place, direct feedback from customers was difficult to obtain. Smaller Swiss companies, in particular, were looking for such direct contact. Given that Switzerland is in itself a travel destination for global tourists, such opportunities exist in key tourist locations such as Lucerne and Geneva.

Kuhn Rikon, producer of pans and cooking utensils, and one of the smaller players among the researched SMEs, focused on B2C marketing and tried to compensate for size with marketing innovations. The company was recognized by the Swiss Marketing Association for its success in brand marketing.

Kuhn Rikon aimed at “selling stories, not products.” Lack of brand power on an international basis had to be compensated by being quicker on innovations. On the distribution side Kuhn Rikon practiced multi-channel marketing. The traditional retail channels such as Migros in Switzerland or William Sonoma in the US, were enhanced through direct sales on TV shopping channels. These TV programs were particularly strong in the UK, Germany and the US, and allowed for demonstrating, and telling about, the products. Online shopping, such as through Amazon and Alibaba Tmall, also became more important, where independent distributors stocking Kuhn Rikon products manned their own “store.” Kuhn Rikon did not sell directly on Alibaba.⁴

The identification of products as *Made in Switzerland* has been made more restrictive under recent regulations.⁵ These changes had considerable impact on Kuhn Rikon, where parts of its product line continued to be produced in Switzerland

³Adapted from Caran d’Ache company profiles.

⁴Adapted from Kuhn Rikon company profile.

⁵Swiss confederation SME portal for small- and medium-sized enterprises. www.kmu.admin.ch. Accessed February 2, 2020.

and others were sourced from external producers, largely from Asia. The company therefore had to adapt its brand marketing globally to fit the new regulations. To get around it, the label *Swiss Designed* was introduced for a segment of its product line, a solution also adopted by other SMEs.

The debate about what constituted *Swiss Made* was of considerable importance to **Kuhn Rikon**. After out sourced products from outside of Switzerland could no longer be advertised as *Swiss Made*, the company, after several false starts, moved towards a differentiated labeling of its product line. The cookware made entirely in its Rikon factory continued to be labeled as *Swiss Made* and the use of the Swiss flag was authorized. The company's kitchen gadget and utensil line could no longer be sold under that label, even if the items were brought to Switzerland and packaged there. Like other firms, Kuhn Rikon changed to label its products as *Swiss Designed*, but had to forego the use of the Swiss flag on its packaging.⁶

Professionalizing the Marketing Process

The migration from selling to marketing and branding was a slow process for most SMEs. Starting out with a technical innovation and dependent on personal selling by the company founder, marketing departments, considered standard today, were slow in coming. Clearly, the B2C companies took the lead. The trigger was often the need to break through the distributor-monopolized contact with local consumers and the sheer difficulty for the Swiss exporter to gain significant customer insights to guide the operations. **Felco** is a case in point. Focused more on B2B users in the agricultural sector, the company also has had a sizeable following among home users, thus making direct consumer knowledge important.

For the first 50 years of its history, there was no formal marketing function or department at **Felco**. The major customer and trade facing activities were selling through distributors, and the building of a related network of independent distributors in many countries. Starting in 1989, in some key areas, Felco set up its own sales subsidiaries, such as in Belgium for the Benelux region, France, Australia, Germany, Canada (2011) and the US (2012). In 2009, Felco created a sales subsidiary in South Africa with 40 percent ownership from local partners. The decision to create a formal marketing department was taken by CEO Laurent Perrin around 2008 when the company realized it needed to better understand its customers. Focus groups and research determined that while the brand was well known and its products were highly appreciated, the company was not viewed as innovative nor was it perceived as listening enough to its customers. When the company realized how many vineyard workers developed muscular problems, the idea of a cordless battery-operated pruner emerged.⁷

⁶Adapted from Kuhn Rikon company profile.

⁷Adapted from Felco company profile.

It's All in a Name

Even the brand name itself can become part of the story a company can utilize to support its global brand image. Possibly, the most unusual story behind its brand name was represented by **Caran d'Ache**. The early founders of the company explained the origin their brand name as follows.

The company adopted the pen name used by the widely known Russian-born French illustrator Emmanuel Poiré (1858–1909), who drew under the pseudonym of **Caran d'Ache**, as the company name and as of 1924 branded all of its products under this name. The appropriated name was related to the Russian term *karandash* for pencil with had its origin in the Turkish language *kara tash* for black stone, the origin of graphite.⁸

Some of the SMEs researched struggled with the adaption of company names to foreign tongues and, in the interest of simplicity and catchiness, changed their name or that of their brand. **Plumettaz**, the cabling equipment maker based in Aigle (VD), early in its history found that customers outside of its Swiss Romandie region mispronounced its name, eventually settling on Plumett as the brand name for its equipment.

Similarly, **Lantal** as a company name was established to be easier to remember internationally. And finally, there was **Sefar**, found that the name resulting from a merger of several companies, **Seiden-Fabrikanten Réunion**, or Silk Manufacturers Union, was too cumbersome and shortened it to Sefar. A similar shortening of the name was practiced by Emil **Richterich & Co. Laufen** into **Ricola**. After all, the name is important!

Marketing and Selling in a B2B Environment

The majority of the researched SMEs operate in the field of B2B. Their customers are not the end users but other, usually technically trained individuals, who incorporate the SMEs' products into other technical solutions. These SMEs are marketing components, parts, modules, or subsolutions that are often critical to the production process or the final products of their customers. Marketing is therefore driven by *technical sales*, which can take various forms. Much of the success of these firms depends on the effectiveness and professionalism of the technical sales effort.

Selective information indicates that many of the early founders also had a strong bent for salesmanship. To go out and face prospective customers, risk being turned down and literally go door to door, were skills some of the early founders possessed. They must have been good communicators because this required them to explain and justify technical improvements to a skeptical audience, often one that was not trained in the of the founder's technical skills. Examples such as **LNS** founding partner

⁸Adapted from Caran d'Ache company profile.

Scemama, **Plaston** founder Frei, and **Bachem** founder Grogg are typical for founder personalities with that skill.

Even today, company owners or CEOs often play the role of CMO by spending a considerable amount of time with customers, visiting them and walking through their plants. **Komax** founder Koch spent considerable time in the plants of his customers, suggesting different ways to improve their operations and gathering new ideas for himself. Attending international trade fairs was another preferred way to meet existing customers, recruit new ones, and exchange information.

Application-Driven Sales

When application-specific selling is critical, SMEs tend to decentralize their sales effort to be closer to the customer. This is particularly true when the engineering task of the product, system, or module has already been completed and the next step is to show customers how to apply this within their own operations. The extent of decentralization varies from company to company.

Sefar employed a large sales force across the globe. The sales force also played a role in application development.

Sefar employed hundreds of technically savvy salespersons. The 26 national subsidiaries also had the task of knowing which industries produced what. It was the task of the sales force to understand how customers handled the filtration processes and to see how Sefar could help. Thus, they understood customer needs and also approached customers on their own. There were lists of strategic industries for every country, which the national subsidiaries had to target. As a result, most of Sefar AG's products and services have been developed in collaboration with customers or were developed almost exclusively in response to specific customer problems.⁹

At **Oetiker**, the manufacturer of clamps and systems used by tier suppliers to the automotive OEMs employed a globally dispersed sales force with deep application know-how in customer operations, who service the thousands of company customers throughout the world.

At **Oetiker**, sales operations were in the hands of a number of application managers, not product managers, who were globally distributed and held regional responsibility. The application managers' task was to spot opportunities and in some cases anticipate as well. The starting point was always the client's needs. Some of these application managers were based at production locations, with the majority operating from simple sales offices only. This distributed sales and customer service operation allowed the company to interface with customers in their own culture and language which Oetiker considered a competitive advantage as many products were in need of customization.¹⁰

⁹Adapted from Sefar company profile.

¹⁰Adapted from Oetiker company profile.

At **LEM**, where sales were partially made from a catalog of components, there remained a need to be close to the specifiers at the individual customers in many different application settings. Maintaining a distributed sales force enabled the company to adapt easily to the specific national and cultural sales settings.

The need to be close to customers led to the establishment of more than 20 sales offices across the world. Its global customer base demanded seamless service worldwide. **LEM** also had to accommodate different selling cultures. In the US Rust Belt, or Midwest, the sales approach was traditional, whereas in Silicon Valley there was a different kind of engineering thinking. This meant LEM had to use two different sales groups to accommodate different sales dynamics by market segments and geographic region.¹¹

Employing Key Account Systems

In cases of large customers which operated in a number of geographic territories, larger companies in the sample also employed Key Account Management (KAM) systems for coordination purposes. Typically, these KAM managers were located at the head office from where they coordinated application or sales teams which were deployed regionally. **Komax**, manufacturer of cabling systems, was a case in point.

Komax sales reflected the worldwide distribution of wire harness producers, particularly those devoted to the automotive industry. All sales and service organizations were company-owned firms, engaged both in sales and service. Sales to global key accounts were coordinated from the head office in Switzerland. Customers were offered a single point of contact for their business with Komax. Only about 2 percent of Komax Group sales were to Swiss customers. Europe accounted for the largest share with about 50 percent, followed by Asia/Pacific with 20 percent, Americas with 15 percent and Africa with 10 percent.¹²

In the case of **Lantal**, location of sales offices and KAM were combined. The company operated sales offices in Seattle to leverage proximity to Boeing, as well as a sales office in Toulouse to serve Airbus.

When an engineering solution had to be finalized upon customer order, requiring considerable design engineering for each product up front, the sales effort was centralized. This was the case for engineering intensive firms, such as **Burckhardt Compression**.

At **Burckhardt Compression**, new machine sales, although global in nature, were from the Swiss base where most of the technical expertise was concentrated. The sales process was highly technical and required considerable know-how regarding the various processes and required installations. The center of competence for sale was thus maintained in Switzerland, with a few sales experts stationed in the US and China. The footprint and organization for the service business was different and more decentralized.¹³

¹¹Adapted from LEM company profile.

¹²Adapted from Komax company profile.

¹³Adapted from Burckhardt Compression company profile.

In contrast, **Sécheron** decentralized its sales activities by placing considerable resources into local markets. The company credits its success in Asia with this redeployment.

EAO, manufacturer of push-button systems, was long geared toward international sales, covering some 50 countries or regions. It adopted the model of direct sales combined with a dispersed sales force.

The **EAO** business model relied on direct sales. Eleven sales companies across the world assisted in this model, resellers were excluded. A sales force of about 50 people, spread out and dispersed geographically, tended to the customers. EAO was of the view that sales contacts needed to be held by people rooted in local customs. The globally spread sales force kept in touch with sales call-ins every three months and an annual two-day sales meeting. Direct links among sales teams and sales companies were encouraged to avoid that connections had to go through the center in Olten. Global segment managers were in place, important for segments such as railroad that was global in nature. Data needed for the sales force, such as the company's CRM system, were cloud-based and could be accessed globally by all members of the sales teams. They were asked to register all complaints in the system, as well as any opportunities spotted.¹⁴

How complex a global sales force and its management can become is best illustrated by **u-blox**. The company marketed its positioning modules and components only through OEMs. The company did not market GPS products as naked products, nor did it market to end users.

At **u-blox**, sales to OEM customers were in the hands of three crews with regional concentration on Europe, North America and Asia/Pacific. These teams could count on the support of 13 sales offices and about 50 distributors in key countries. The opening of international sales offices started early, with u-blox opening US and Asia offices in 2001. In 2018, u-blox geographic sales were about evenly divided between Asia/Pacific (35 percent), Europe/EMEA with 32 percent and Americas with 32 percent. Sales to Switzerland, the head office location of the company, accounted for less than one percent. Coordination of the sales effort was largely the responsibility of the newly created position of CMO. Sales teams and their members traveled extensively. The sales teams worked on requests for products placed by OEMs. u-blox sold components and chips, with the former accounting for the majority of sales.¹⁵

Global Sales Practices in the Medical Cluster

For SMEs that are part of a *medical cluster*, it is important to alert readers to the special practices these firms followed. **Geistlich** und **Medartis** demonstrated similarities in their sales approaches by adopting a special form of focus on specific customer franchises or professional groups. The need to get close to these professional groups, dental and orthopedic surgeons, required the fielding of a highly specialized sales force that could access the practicing surgeons directly.

¹⁴Adapted from EAO company profile.

¹⁵Adapted from u-blox company profile.

In line with the company's orientation, a specific business model was required. **Geistlich Pharma** customers were dental surgeons located all over the world. In order to reach dental surgeons, the company put its emphasis on direct sales and meeting customers at conferences, actually conducting its business without a formal sales force. Surgical procedures could be demonstrated during those conferences. To support the educational effort that went into communicating the use of biomaterials for bone enhancement, the Osteology Foundation was created in 2003. A second foundation, the Osteo Science Foundation, was established in 2013 and also supported by Geistlich. The company efforts did not only help the sale of its products, but contributed greatly to the increased use of regenerative bone materials globally. Geistlich dominated this niche in whose creation the company had played a major role in the first place.¹⁶

In order to reach its chosen customer franchise of orthopedic trauma surgeons, **Medartis** preferred a direct sales force for most of its customer contacts. For a company with about 550 employees globally, some 200 were in its field sales force, employed full time by Medartis and based on its international subsidiaries. The deployment of such a large field sales force, coupled with an industry and company experience averaging 11 years, gave Medartis the needed control influence over the sales process, surgeon education, and surgeon training.

International expansion at **Medartis** began in 2002 with the opening of sales offices in Germany, Austria and France. Other sales subsidiaries followed: in the UK (2003), the US (2004), in Mexico and Poland (2008), and in Australia and Spain (2010). The most recent sales subsidiaries were formed in 2018 through the acquisition of a local distributor in Brazil and a new operation in Japan. In addition to its 11 sales subsidiaries employing about half of its staff, Medartis products were also sold in 40 countries through 35 distribution partners, collectively accounting for about 15 percent of sales.¹⁷

SMEs in the medical cluster that developed cutting-edge technology would not be able to achieve the needed sales volume to monetize such development without a large field sales force of highly skilled professionals capable of gaining the confidence and trust of the surgeons. For these firms, the global sales force accounts for as much as one-third of their total head count.

The Importance of Lead Customers

A review of the sales histories of many of the SMEs points to the important role played by a lead customer. A lead customer is not merely a customer who became an early buyer but is also one that resonated in the industry and literally *put the company on the map*. Some of our SMEs showed considerable skill in grabbing such opportunities and often outdid much larger competitors who were not willing to go the extra mile to satisfy a special request. The examples given below show that a

¹⁶Adapted from Geistlich company profile.

¹⁷Adapted from Medartis company profile.

lead customer can emerge at any time during the development of an SME, be it at the beginning, in mid-career, or during times of distress.

Wyon, producer of specialty batteries, was still in the process of troubleshooting its prototypes when an Australian company arrived at its doors to eventually become not only a lead customer but a launch customer.

In 2001, the **Wyon** founders had the first prototypes, still not optimal and with some faults, when a representative of a large Australian company and worldwide leader for cochlear implants, appeared on the stage. The company had been looking in vain for a supplier to produce rechargeable batteries for their purposes. At that time, they were still collaborating with Phonak, a leading Swiss hearing aid producer, who recommended to approach Wyon. The Australians came to Appenzell when Wyon was still operating out of a garage. Wyon convinced them that they were the right partner and commenced the development of a first prototype. CEO Philipp Wyser explained the specific market niche of Wyon as follows:

If you go to a battery manufacturer and say that you want a special shape, then the first question is: 'In what quantity?' The Australians only needed 30–40,000 batteries a year, and then the battery manufacturer typically said: 'Here you have my catalogue, choose a standard battery. If we're talking about a million a day, we'll make a special one for you.' They just don't do that, it's not worth it for them to change their equipment for 30,000 units. *In principle, this is also part of the market niche we have worked on, that we are somewhere where others don't want to go* (Wyser, CEO).

Wyon targeted the implant hearing sector because the normal hearing aid sector was simply not yet 'ready' for rechargeable batteries, as audiologists partly earned their money selling replacement batteries. In 2005, Wyon moved out of the garage, rented the first commercial premises and started with serial production for their first customer.¹⁸

By going the extra mile, Wyon was able to compete in a niche that the large battery producers were unwilling to invest in. To be able to grab such an opportunity and become a reliable supplier is a typical game where many Swiss SMEs excel.

FISBA chose to take the route of an exclusive OEM arrangement, one that lasted from 1965 to 2016. The OEM arrangement, while providing a steady customer over decades, came with restrictions and exclusivity and was eventually terminated. Having matured, FISBA could develop beyond its lead customer and find new business.

In 1965, **FISBA** initiated a cooperation with **KARL STORZ**, a large German endoscope producer, for which it exclusively produced micro-optics. For a modern endoscope to provide brilliant images of hidden body cavities the key parameters were light intensity, depth of focus, magnification, contrast, and resolution. FISBA focused on design, its traditional strength. FISBA tried to develop customized designs and then to become the manufacturer of the product. As a result of this cooperation, FISBA's business grew at a steady pace. Three times FISBA expanded into new production facilities, serving as "extended work bench" and strategic supplier in micro-optics for **KARL STORZ** until 2016.¹⁹

¹⁸Adapted from Wyon company profile.

¹⁹Adapted from FISBA company profile.

Plaston, expert in producing plastic components through injection molding processes, had been operating for a good 20 years, producing components for both industrial and consumer applications, when the company was contacted by Hilti, a large global company in the power tool market. Hilti, located in nearby Liechtenstein, had decided to close its in-house plastics laboratory and offered Plaston its equipment for sale. The companies were located only about 30 min from each other by car in the Rhine River Valley, on the Eastern border of Switzerland.

Hilti had just made the decision to close its in-house plastics laboratory and had offered its surplus equipment to **Plaston**. During a visit to the Hilti warehouse, Hans Frei, the Plaston founder, discovered piles of red metal cases used to package Hilti power tools. “These cases could also be made out of plastic” said Frei. Hilti replied, “We already have enough problems with our power tools, we don’t want to add more problems with the cases.” Frei did not take no for an answer and for the next two years, he, his son Roland and a small, dedicated team worked hard to create a series of prototypes with the hope of impressing the people at Hilti. Maybe it was the constant pressure, but Hilti finally agreed that Plaston could produce cases for one of their power tool models, at Plaston’s own risk. Eventually, Hilti’s decision to sell their complete line of products in specially designed Hilti red cases was both a confirmation and a challenge for Plaston, because the scope of this project went beyond everything Plaston had ever experienced before. Three more product lines for Hilti would follow in 1980, 1990 and 2005. By 2010, 40 mio cases were sold and the fifth generation of cases was in development.²⁰

The persistence of Plaston founders and family paid off handsomely, providing the boost the company needed to launch an extended period of growth. Eventually, many other companies turned to Plaston for similar products, but Hilti remained their largest customer. The red plastic cases for Hilti power tools can be seen on building sites all over the world.

Even well run, growing and profitable companies can profit from the emergence of a single lead customer as demonstrated by **Thermoplan**. Started in 1974 by Domenic Steiner, the company had grown from the business of installing institutional kitchens to producing cold cream and milk foam whipping equipment for use in coffee bars. After some business associates had suggested that Thermoplan try to combine its equipment and build it into a fully automatic espresso machine, the company brought its prototype to a fair in Basel.

Official market introduction took place at the Basel fair in 1997 where **Thermoplan** as a newcomer for automatic professional coffee machines, caused quite a stir. Adrian Steiner, later to become CEO of Thermoplan, remembered the situation at the Basel Fair exhibition booth.

The Thermoplan team manning the booth was visited during the fair by three guys from Seattle: Peter, Paul, and Larry. They were intrigued by the Thermoplan solution and informed the team that they were from a coffee chain named Starbucks, a company that was not known to the Thermoplan team at that time! The Starbucks team let the Thermoplan

²⁰Adapted from Plaston company profile.

team know that they were looking at some 14 different machine suppliers and required a machine that could deliver both speed and consistency (Steiner, CEO).

After an evaluation of several machine suppliers, Starbucks included the **Thermoplan** as one of three suppliers in its six months' testing phase and allocated to Thermoplan a site in Vancouver, Canada. As Steiner recalled: "This was not the typical Rössli in Switzerland." Over the six months' pilot testing phase, Thermoplan managed to constantly adjust and improve its machine, impressing Starbucks with both flexibility and performance. This was the time when coffee tastes in the US began to change and the preference for coffee latte was just about to take off. In 2000, Thermoplan signed a long-term, exclusive, global supply contract with Starbucks for all its coffee shops. At the time of this negotiation, Thermoplan had about 35 employees. For Thermoplan, just two things mattered in this contract, the rest was viewed as legal jargon. First, the purchasing terms were in CHF and not in USD, eliminating any currency risk. Second, payments were to be made within ten days after invoicing. This was critical for a company that was sourcing most components from small local suppliers and could thus provide financing to them.²¹

The willingness to take the plunge with a lead customer, such as Starbucks about to roll out its stores worldwide, when the company was still very small, proved to be decisive to allow Thermoplan to grow its business to CHF 300 million in less than 20 years.

Selectron, a producer of in-train electronics, was a last example: When new management took over in 2000, the company had been in decline for its last 10 years of operation and was slated to be liquidated. The newly appointed management was actually able to engineer a complete turnaround from industrial electronics to in-train electronics by capitalizing on its relationship to the SBB as its initial lead customer, and later by riding the coattails of Stadler Rail, a newcomer who grew to a dominant player in the suburban train segment.

Selectron's competitiveness as a supplier to the Swiss Railway was based upon its willingness to varnish the electronic controls and select ruggedized components to meet the stringent requirements for train operations and the fact that in the past, to compete in the machine tool automation segment, the company had consistently reduced the size of its controllers, which helped to fit items into the tight spaces of railway cars. If the PLCs were not varnished, the reliability of the equipment was not assured. Condensation caused by temperature differences, as well as dust accumulated from steady use, could result in short circuits in the system. Major automation suppliers were not interested in taking this extra step and would force the railway operator to use unwieldy protection boxes instead.²²

The successful fulfillment of the SBB's contract for retrofitting refurbished rail cars with in-train automation control systems led to further developments that helped **Selectron** to latch on to OEM train builders for new equipment. In Europe, half of the new train market was dominated by three large international players who all had their own in-house train automation departments and were not interested in an external niche supplier. The other half of the market, supplied by smaller, regional train builders, was dependent on sourcing in-train electronic control systems and at

²¹Adapted from Thermoplan company profile.

²²Adapted from Selectron company profile.

the same time hesitant to do so from the larger integrated companies who were also their main competitors. By supplying Stadler Rail, the emerging leader among this second segment, Selectron was pulled into the market as a new equipment supplier. What was once a small business of just about CHF 2.5 million grew into a sizeable international business of CHF 70 million. Stadler remained the largest customer, albeit Selectron could gain other customers as well. A company slated for liquidation was rejuvenated through its close relationship with its lead customer Stadler.

Review

B2C SMEs generally followed branding practices that were widely followed in consumer marketing. SMEs in this segment, however, were challenged to operate with relatively smaller budgets, thus requiring innovative branding practices that conserved their limited budgets (**Caran d’Ache, Felco**). **Jura** and **Ricola**, larger and thus able to invest greater resources into brand building, could aim for globally oriented campaigns, though both companies also chose tactics that respected their limited resources.

The B2B set of SMEs emphasized selling through a professional and technically trained sales force that could also solve customer problems (**Medartis, Geistlich**). This more consultative style of sales representation called for a globally dispersed sales force (**LNS**) with heavy reliance on key account selling (**Komax, Lantal, u-blox**). In order to facilitate new product introductions, lead customers proved helpful to open doors elsewhere once they were fully satisfied (**Wyon**). The lead market concept was particularly important for smaller companies, since it conserved on the expensive selling resource by focusing it on one, or a few, target customers prior to expanding market coverage to a greater number of prospective clients (**Thermoplan, Selectron**). In some instances, these relationships became quasi-institutionalized and continue to last for long periods (**Plaston, FISBA**), serving the SME as anchor points for further market expansion.

Open Access This chapter is licensed under the terms of the Creative Commons Attribution 4.0 International License (<http://creativecommons.org/licenses/by/4.0/>), which permits use, sharing, adaptation, distribution and reproduction in any medium or format, as long as you give appropriate credit to the original author(s) and the source, provide a link to the Creative Commons license and indicate if changes were made.

The images or other third party material in this chapter are included in the chapter’s Creative Commons license, unless indicated otherwise in a credit line to the material. If material is not included in the chapter’s Creative Commons license and your intended use is not permitted by statutory regulation or exceeds the permitted use, you will need to obtain permission directly from the copyright holder.



Product Building Choices

For exporting SMEs, their product mix invariably plays a central role in their success. For most of these firms, building and designing products constitute the core activity and, therefore, a good part of the research and the interviews focused on this process. This section will highlight five elements that repeatedly turned out to be central to the companies' strategies. The following are the five elements.

- **14 Production Footprint Choices**

How do SMEs decide on arranging their production footprint, trading off production in Switzerland versus offshoring? How do they decide on component sourcing? And, how do they deal with asset plays related to production?

- **15 Production Process Choices**

How do SMEs *arrange their factory floor* and what kind of processes, proprietary, or other, do they employ, including the extent of automation?

- **16 Product Design Choices**

How do SMEs deal with the tradeoffs between functionality, design, and ergonomics to compensate for a high-cost production basis?

- **17 Product Line Choices**

How do SMEs deal with requirements for product line depth versus breadth, and in particular, how do they manage to use platforming and modularity to maximize product variations and increase the number of stock keeping units (SKUs)?

- **18 Supply Chain Choices**

To what extent do SMEs consider involvement in production a necessary element of their strategy and how integrated is their own value chain?

The documented SMEs have made very distinct choices relating to these questions. It should come as no surprise to the reader that these choices are often quite different and are closely related to the focus and segment choices discussed in earlier sections. All of the researched companies, however, have found a combination of the issues above that will eventually contribute to their competitiveness on world markets, even if the combinations chosen are not identical. At the end of this section, *strong combinations* of the above practices will be pointed out.



Of the sample companies below, about half of them maintained an exclusively, or predominantly, Swiss-based manufacturing footprint. The other researched companies exhibited varying degrees of production delocation—ranging from partial assembly to full production, having a distributed footprint with largely international production or, in a few cases, moving all the way to full offshoring.

Exclusively Swiss-Based Production

An exclusively Swiss-based production footprint was maintained by 12 out of the 36 companies researched. Exclusively meaning that all production and final assembly steps took place in Switzerland except for material or component purchases of elements not available locally. The majority of these companies were on the lower sales volume range, although several of them belonged to the above CHF 300 million range.

Three companies, that can be considered part of this *purist* group, are featured below.

DC Swiss operated two manufacturing sites, both in the Jura Bernois. The main site in Malleray produced all finished tools since 1962. In 1990, a second site was opened in nearby Bevillard, taking over an existing building site producing tool blanks only. This allowed a further expansion of manufacturing space for finishing tools in Malleray. Between the two sites, the company produced more than 5,000 tools daily, or about 1 million tools annually. The average net revenue per tool amounted to about CHF 20. DC Swiss had several thousand SKUs, of which most were considered standard. The company operated a modern machine park with many CNC machines for grinding tools to specifications. Acquiring new production equipment represented some of the major investments beyond building construction.¹

¹Adapted from DC Swiss company profile.

Felco's production base was still in Les Geneveys-sur-Coffrane, the same village in the Jura Bernois where the company was originally founded. The site in the central part of the village had been expanded several times to include a number of different and adjacent buildings. The factory produced about 5,000 units of different tools per day. The key aluminium handles were produced by a separate, company owned, producer in the Canton Jura. Eric Perrin, son-in-law of company founder and CEO of Felco from 1974 to 2002, strongly believed in investing in people and keeping local jobs in the Jura region. Aside from some exceptions, no production was moved offshore, such as to China. Some accessories were also sourced abroad.²

Caran d'Ache was committed to remain and produce in Switzerland, eliminating the option of moving across the border into nearby France. The label 'Made in Switzerland' required a Swiss production site. With about two thirds of company staff involved in production, finding the right talent was important. In the Geneva region, there was access to talent steeped in manufacturing products from metal, such as for watch making. But for many of the Caran d'Ache processes, staff had to be trained in-house with retention being an important consideration. On average, employees had been with the company about 15 years with some for as many as 40 to 50 years. Although the company participated in apprenticeship programs, for core manufacturing processes only in-house training would suffice as there were no other employers with similar needs in the region.³

Management at these smaller companies was conscious of the cost penalty incurred, compared to international competition, by maintaining their production in Switzerland. By engaging in step-by-step automation, they tried to compensate their cost-differential through higher productivity per man-hour. In addition, they believed that they are gaining substantial quality benefits through a specialized and highly trained labor force that more than justifies the Swiss location. Last but not least, by remaining in Switzerland, they were able to use the label *Swiss made* as a quality symbol, which would justify a premium price in most markets.

Among the larger companies in the sample, **Jura**, although having outsourced its production, used a Swiss-based contract manufacturer for its entire output, allowing the company to trade under the *Swiss made* label. **Ricola** remained attached to its location in Laufen for its entire production. The company's production was organized into two long shifts with most of the employees recruited locally. The efficiency of the production operation, including automation and robots, allowed Ricola to compensate for otherwise higher salary costs compared to neighboring countries. From its inception, **Thermoplan** had relied on local Swiss suppliers for its components, made to specifications as per Thermoplan engineering designs. At its Swiss base in Weggis (SZ), Thermoplan concentrated on assembly operation and quality assurance, since more than 90% of its sales went into exports. All three companies had organized their business systems in such a way that they could achieve global competitiveness despite operating from a Swiss base.

²Adapted from Felco company profile.

³Adapted from Caran d'Ache company profile.

Modified Swiss Manufacturing

Although maintaining a mostly Swiss-based manufacturing footprint, some companies found a need to offshore some assembly processes for marketing and cost reasons. These arrangements typically dealt with parts of the product line only. Three firms featured here belong to this category. All of them have their main manufacturing site in Switzerland: **Sylvac**, **EAO**, and **Pilatus**.

Sylvac made different manufacturing arrangements for its own branded line, compared to its OEM branded line which went mostly to Asian distributors.

All products sold under the **Sylvac** brand name were assembled in Switzerland and the company had no plans to produce in China beyond its OEM business, which was not sold under the Sylvac brand. The China operation near Shanghai had a dual role. First, it was to help with the sourcing of components to be sent to Switzerland. Second, it was as an assembly point for those tools traded through OEM arrangements in the Asian region. Concerning the calipers product line, the company sourced blank calipers abroad and finished them in Switzerland.⁴

Mikrop, a leading manufacturer of high-end micro optics, maintained its main production base in Switzerland. However, the relatively high cost of conducting business in Switzerland was regarded as a disadvantage. Labor costs and building costs, for example, were significantly higher than in other European countries. In addition, an extraordinary phase of appreciation of the Swiss currency meant that Mikrop could only benefit to a limited extent from cheaper purchasing prices abroad. To counter the high costs in Switzerland, Mikrop outsourced part of the production to Serbia. This facility was used for the production of standardized, basic products.⁵

EAO maintained a major assembly operation at its main location in Olten where the company also managed sourcing of parts and components. Three assembly points for specific products were maintained in Germany, the USA, and China.

Among its four manufacturing operations, the **EAO** Swiss plant in Olten was a major assembly point. The operation in Germany carried out the assembly for automotive applications and off-road vehicles. The US assembly operation was geared towards public railways projects where local content was important. China was described as the 'work bench' for assembling standard products based largely on imported components, as well as serving local Chinese customers with localized HMI products.⁶

Pilatus, the company with the largest Swiss-based manufacturing footprint among the researched companies, had a sizeable workforce of close to 2000 employees on its main site in Stans. Pilatus manufacturing operations had been expanded continuously over the years. Production has gone from 50 units annually around the year 2000 to about 125 units annually today. Half of its employees were involved in manufacturing operations. Planes destined for US delivery were

⁴Adapted from Sylvac company profile.

⁵Adapted from Mikrop company profile.

⁶Adapted from EAO company profile.

customized in its Colorado operation in the USA where more than 200 employees, worked mostly on general aviation models.

Swiss and International Production

About one third of the companies established substantial production capacities outside of Switzerland. The Swiss base remained significant, but for some parts of the business the international production assumed a much greater role than in the previously cited companies. The triggers for the internationalization varied. While some companies were more driven to remain cost-competitive, others followed the demands of their customers, or acquisitions abroad came with production assets. Both **Rüeger** and **Fraisa** moved some basic manufacturing operations abroad to Asia and Eastern Europe, respectively, in order to save costs and remain competitive.

At **Rüeger**, manufacturing of its instruments had always been central to the development of the company. At its plant, Rüeger manufactured core components on the basis of its own temperature measurement technology. Production processes and equipment were designed and built by the company and could not be acquired on the open market. As the company expanded in Asia, final assembly of its instruments was moved into Malaysia, where standard products were also produced. For the pressure gauge segment, products were sourced externally as that market had commoditized and could not be served any longer from the high-cost Swiss base. These policies were reflected in the headcount of the Swiss operation. Whereas employment 20 years ago was 120, it had now shrunk to about 70, with about 45 in production.⁷

Fraisa's manufacturing footprint had undergone both expansion and contraction over time, while becoming increasingly globalized. Manufacturing operations at its Bellach plant in Switzerland was now the only production point in Switzerland with two others closed during the crisis years. The operation in Hungary, first started in 2002 and expanded in several steps, comprised more than 150 employees today and produced around 55 percent of Fraisa standard tools. Since the Swiss Franc gained more and more strength over the years, Fraisa's good economic situation had largely to do with the internationalization of its production.⁸

Other than establishing a weaving plant in France in 1911, **Sefar** did not engage in any large-scale production abroad until the mid-1990s when distributors were acquired, and Asia emerged as a major market. The imbalance between cost accruing in Switzerland and sales taking place abroad was a major issue for the company.

The most important step at **Sefar** was the construction of a weaving plant in Thailand in 1996, to meet increasing demand in Asia, followed by the establishment of a new weaving plant in Romania in 2007. Following the opening of the production sites in Thailand and Romania, the remaining production sites in France were closed. In 2018, the volume of tissues produced abroad was 40%. However, the majority of weaving machines were still operated in Switzerland. The expansion of production abroad was driven by the objective of

⁷Adapted from Rüeger company profile.

⁸Adapted from Fraisa company profile.

reducing the imbalance between the country generating the largest portion of costs (Switzerland), and the countries generating yields. Even in 2018, only 2–3 percent of its sales volume came from Sefar’s Swiss customers while more than half of the costs was accrued there. This mismatch had become a great challenge when the Swiss Franc began to appreciate strongly in the 1970s, and even more so later on.⁹

The experiences of **Sécheron** and **Burckhardt Compression** were based upon shifting component manufacturing and assembly for their entire operations, but in opposite directions. On the one hand, Sécheron moved parts of their manufacturing to Eastern Europe but assembled at its Swiss site in Geneva. Burckhardt, on the other hand, acquired local assembly operations abroad and supplied them with key components, amounting to about 80% of the final product. Sourcing the rest locally, plus saving on assembly labor costs, made the final product more competitive.

At **Sécheron**, the Geneva site continued to be used for final assembly and testing of components, as well as research. This meant that customers took ownership of products in Geneva, projecting the *Swiss Company* and *Swiss made* image. Head count there varied, ranging from around 240 to 280. Major changes took place in Sécheron’s Prague components manufacturing operation. At the time of starting the turnaround in Geneva, the new owners realized that they also had to accomplish a turnaround in Prague. The operation there, formerly a site under Communist control, needed to be moved into a Western-style performance culture with the infusion of young people. The operation in Prague was brought to a European level in terms of costs, even while currency values moved substantially. Starting out with a workforce of 230, the Prague operation first declined to about 170 and then grew back to 550.¹⁰

By the end of WWII, employment at the **Burckhardt** factory in Basel and other locations topped 500, a number that stayed constant until the business was merged into the Sulzer Group. This merger brought about the consolidation of all manufacturing activities in Oberwinterthur where employment amounted to about 330 persons at the time of the MBO, with another 100 in international operations abroad. About 80 percent of all manufacturing took place in Oberwinterthur. Burckhardt was able to acquire the compressor business in India run by Sulzer Group in 2005. Additional assembly facilities were opened in Korea in 2015 in the vicinity of a shipbuilding cluster, as well as in Waller, Texas, to assemble compressors destined for the North American market and for customers where local assembly was important. The US plant sourced the critical components from Switzerland, and the rest, about two thirds, from US suppliers. Through the acquisition of the leading Chinese piston compressor manufacturer, Burckhardt gained access to the Chinese local market through assembly of its own compressors and as a sourcing point for components to be used in its Swiss and US assembly plants.¹¹

Acquisitions led to additional manufacturing assets for some companies. **Filtrox** acquired the operation of a smaller competitor in the UK, then entered the Czech market through a joint venture, and finally acquired a filter producer in Mexico to

⁹Adapted from Sefar company profile.

¹⁰Adapted from Sécheron company profile.

¹¹Adapted from Burckhardt company profile.

supply the US market. The result of these acquisitions was a shift of employment toward the foreign operations.

Major customers can also have an impact on the manufacturing footprint as the experience of **Plaston** demonstrates. Two of its major customers for plastic packaging systems drove Plaston to localize production in Eastern Europe and in China, posing considerable challenges for a medium-sized company.

In 1985, Bosch became **Plaston**'s second key account for packaging systems, after Hilti. In the early 1990s, Bosch inquired if Plaston would consider producing the cases closer to its factory near the Czech border. The project in Sluknov rapidly took shape. Plaston acquired an existing 5,000 m² production facility in 1995 and soon began to produce their first cases. To this day, this plant has continuously operated production in three shifts.¹²

The decision to produce in the Czech Republic strengthened the relationship with Bosch. Building electrical appliances involved considerable assembly work, and the Sluknov location offered both a qualified and cost-competitive labor force. Lower manufacturing costs, combined with items purchased in Eastern Europe, allowed Plaston to establish a foothold for its Boneco air treatment products in the competitive US market.

The experience of the companies that expanded their production footprints abroad demonstrated that this was done either to protect the cost competitiveness of their business or to hang on to key customer relationships, leading to additional business. In general, the Swiss production base remained intact although it did not grow as additional workforce growth took place abroad. In all cases, the success of international expansion contributed to the health and sustainability of the Swiss production base.

Globally Distributed Production

A few of the larger SMEs surveyed moved beyond their Swiss production base to build true global networks, with varying roles for the Swiss home base. These companies had sales in the range of CHF 200–500 million. Typically, they built production networks with distributed production mandates, usually specializing on parts of their product line, or they created supply networks in the vicinity of a global customer base.

LNS, the producer of machine tool peripherals such as bar feeders, grew from a single-site operation in Switzerland through acquisitions of manufacturers of other peripherals that were then integrated into a coherent international sales strategy.

At **LNS**, the establishment of Japanese, Taiwanese and Chinese manufacturing centers, and the acquisition of Turbo Systems in the US, led to a complete realignment of manufacturing mandates through the LNS group of companies. The supply strategy was based on

¹²Adapted from Plaston company profile.

manufacturing in three regions, with the Asian production centers concentrating on supplying Asian markets; the US, with a staff of 150 across two production sites, on North America; and, the European factories in the UK, Italy and Switzerland concentrating on supplying European customers. At the Swiss site, the regionalization strategy impacted on staffing levels. Employment dropped from a maximum of 130 to about 80 employees now. For production staff alone, employment dropped from a onetime high of 100 to about 30 as the Swiss site concentrated on the assembly of the advanced bar feeder systems with some parts supplied from the Chinese operation. Overall, the Swiss site produced only about 10 percent of the LNS Group revenue. Engineering activities for bar feeders were carried out in Switzerland, Taiwan and the US. Since the key elements of engineering and design were concentrated in Switzerland, LNS traded under a *Swiss Engineering* label.¹³

Although **Komax**, the supplier of cabling systems, also pursued a strategy of assembling a number of peripheral equipment, similar to LNS, the impact on the Swiss manufacturing base was not negative and did not hinder Swiss employment growth while the production site experienced continued expansion.

Komax operated 19 production sites of different size, mandates and tasks. By far the largest production site was its Swiss plant in Dierikon (LU), subject to a major CHF 70 million expansion for 2019–2020 and was the center for standard equipment and systems. Sites in Germany focused on customized equipment or systems, such as for solutions and client-specific systems, for taping and for testing equipment. The site in Hungary concentrated on development and production of solutions of high voltage cables for electric mobility. The operation in Japan was dedicated to benchtop machines and the China operations were mainly for the Asian market. Other production points were for engineering and assembly of testing systems for the local markets. These sites were located in countries where wire production was concentrated, such as Turkey, Bulgaria, Rumania, Mexico, Brazil, Tunisia and Morocco.¹⁴

What separated Komax from LNS was that Komax did not move Swiss-based manufacturing mandates to new acquisitions abroad which manufactured new and different elements not made at the main site in Switzerland. A different strategy was again pursued by **Bachem**, where production mandates were assigned to different locations on the basis of regulatory approvals and geographic market assignments.

Although **Bachem** covered the world market with its product supply, manufacturing was concentrated at six locations in Europe and North America that also doubled as development and marketing locations. Production of chemical substances ranged from milligram amounts for pre-clinical work to tons for active pharmaceutical ingredients (API) or key intermediates. Equally, the company possessed capacity to produce small molecule generics and new chemical entities (NCE) in multiple tons. By far the largest production site was in Switzerland (Bubendorf) where Bachem has produced since 1971. Production API was current good manufacturing facility (cGMP) approved by the US Food and Drug Administration (FDA), allowing for shipments to many countries and into the important US market. The Bubendorf site also produced research products listed in the Bachem catalog and was approved by the Japanese Ministry of Health for deliveries to Japan. A second Swiss site in Yvonnaz focused on APIs and complex organic molecules. The two sites in the United States

¹³Adapted from LNS company profile.

¹⁴Adapted from Komax company profile.

were also FDA approved for cGMP and one site was approved for deliveries to Japan. The UK site concentrated on producing non-cGMP research products.¹⁵

Two companies, **Oetiker** and **maxon**, had adopted strategies of exporting entire product lines, or parts thereof, with different impact on their main Swiss sites. In the case of Oetiker, the strategy led to a slimmed-down production of key elements needed by international sites, whereas maxon duplicated parts of its production elsewhere for capacity growth but continued to maintain its Swiss production volume and employment. “maxon does not transfer production, we duplicate it elsewhere,” Eugen Elmiger, CEO maxon has said.

maxon maintained its largest production and development base in Sachseln (OW), employing about half of its global workforce. The Swiss operation engaged in all manufacturing activities, including assembly, for which the company also employed some home workers in the region, mostly women who tended to have higher manual dexterity than men. The Swiss operation also tested assembly and production lines before they were added to overseas plants. As maxon grew in headcount at its Swiss plant, so did the difficulty of hiring staff. The Canton of Obwalden (OW) offered only a small labor pool and with a lack of expansion capability the company risked having to extend delivery times and losing flexibility. In response to this growing trend, maxon decided to open a manufacturing plant in Sexau, near Freiburg in Germany, with concentration on gears. The gears were first developed and designed in Switzerland and then transferred for production to Sexau. With expanding volume, the business unit for mechatronics and dental applications were also concentrated in Sexau.

The mentality in the Schwarzwald region of Southern Germany is similar to Switzerland, making collaboration and integration of operations easier (Elmiger, CEO).¹⁶

While **maxon**'s first move abroad was driven by a limited labor pool in Switzerland, later moves were a response to cost pressures as a result of Swiss currency appreciation that led to open manufacturing operations first in Hungary and later in Korea. It is notable how maxon compares costs between its different manufacturing operations, using the concept of and not cost per man-hour as in some other companies.

In comparison to **maxon**'s operation in Switzerland, wage costs in Hungary were about one-fifth while at the same time offering a sufficiently trained labor pool to recruit and build an operation. Starting small in 2001 with just a small team, the operation was expanded in several steps to account for a labor force of several hundred. The Hungarian plant engaged in production and assembly. Without access to the latest in winding technology. Growing business in Korea led to the creation of a production unit there as well. Growing out of a successful distribution business, the Korean operation began with the production of brushless motors as winding around iron was easier to accomplish. Later, a robotics operation for iron cores was added in 2013. On a comparative basis, labor costs in Korea were about one-quarter of the Swiss level. Despite the wage level differences, the Swiss

¹⁵Adapted from Bachem company profile.

¹⁶Adapted from maxon company profile.

operation was still competitive on the basis of profit-per-person, the key operating metric used at maxon.¹⁷

Oetiker Group adopted a different strategy. When the research team visited the company, they were received by Thomas Meier-Bickel, CEO and grandson of the founder, with the comment: “We are not a typical export company.” The company operated 12 foreign production operations, each with a number of production lines. Since most production took place in the currency areas of Oetiker’s customers, the distributed number of plants worked as a hedge against currency fluctuations centering around the ever-appreciating Swiss Franc.

At **Oetiker**’s head office location in Horgen (ZH), staffing was about 110 out of the global headcount of almost 1,900. Production activity in Horgen focused on core stamping tools needed for the 12 foreign production operations. Key tools were needed for the stamping operations, assembly tools and critical components for production machinery placed in the various foreign production operations. Production equipment was proprietary and engineered or adapted by Oetiker for its own needs. Most production plants were for clamps and a few were also producing tools needed to apply the clamps in assembly operations of Oetiker clients. Production was organized around process lines per product and the various production operations contained a different number of such process lines. The size of the production operations ranged from 70 employees for the smallest unit to 350 employees for the largest unit.¹⁸

Typically, the clamp operations were located near clusters of customers, the tier automotive suppliers. Main production centers were located in Europe (Germany, Spain, Sweden, Lithuania and Poland), in North America (US and Canada for four plants in total) and Asia with plants in China and India. The production centers all produced the most common clamps or lead products and some specialty clamps were produced in selective locations only according to local customer requirements.¹⁹

For Oetiker, its tier automotive customers required production in the vicinity of their assembly operations, thus making exporting from the Swiss home base logistically impracticable. The added benefit of such a distributed production footprint was the currency hedge against the continually appreciating Swiss Franc.

LEM, the Geneva-based electricity measurement company, also maintained a global manufacturing footprint similar to Oetiker. Since the company manufactured its components for a large number of clients, the company could concentrate its manufacturing in fewer places. Similar to Oetiker, its workforce in Geneva is small compared to the global total but, in contrast, had remained stable over time, albeit with a changing composition in skills and functions.

The largest concentration of **LEM** employees was in China with a workforce of about 900. China was first and important market for LEM, also turning into an important production point. China was rapidly becoming the largest single market for LEM with about one third of

¹⁷Ibid.

¹⁸Adapted from Oetiker company profile.

¹⁹ibid.

sales. More than half of LEM's production capacity was now in China. In Europe, the largest production center was in Bulgaria with about 260 employees. The Bulgaria expansion was both a response to bring the Euro-denominated sales and production in balance, as well as leverage the local technical university in Sofia for engineering talent. In the US, LEM maintained a customization hub to adapt modules to US standards in terms of software, cables, and other interfaces. Japan was still a small production base focusing on local product specialties as well as on sales to Japanese customers.²⁰

As a volume manufacturer of high-quality products, **LEM** produced on automated production lines combined with skilled assembly and testing. Although the company did not divulge production volumes, outsiders have estimated the output at more than 60 million units. In line with the evolution of LEM sales, its manufacturing set-up changed. When the company commenced operation in 1972, everything was Geneva-focused. With the founders' strong ties to the local community and government, relocating operations was not a consideration. However, given the increasing price pressure, relocating assembly lines into cost competitive countries accelerated during the previous and current decade. Geneva continued to employ a significant workforce of 280 with its composition changing over time. Gone were the high volume production and assembly lines. An ever-increasing number of staff worked in product management, R&D, industrial engineering, front-end innovation, marketing, supply chain management and sales. The Geneva site still produced the specialty components, was involved in prototyping and checked and verified new production lines set up elsewhere.²¹

A recurring theme of SMEs developing an ever more global manufacturing footprint was the impact on the Swiss main location. As documented, production in Switzerland, if maintained, focused on core components that were closely tied to the company's core technology. The establishment of foreign production allowed these companies to partially hedge against the continually increasing Swiss Franc in a way those producing only in Switzerland could not. However, the growing complexity of steering the global footprint also demanded a different skill base at the head office, moving from mere manufacturing to increasingly include engineering, prototyping, and development, as well as global marketing coordination. Even in cases where the mere headcount in Switzerland was maintained, it then encompassed very different professional groups.

The companies described in this section are in many ways miniglobal companies: global in market reach and coverage, and global in production footprint. They differ from the much larger multinational corporations in terms of size and focus around a single business, industry, or customer group. These companies, having grown to a size of CHF 200–500 million, would not have been able to grow to their present size without expanding their operational footprints beyond Switzerland. As a downside of this expansion, it is worth remembering a comment on colocation of manufacturing and development from the CEO of **Medartis**, Willy Miesch: *All relevant production and process knowledge was owned by Medartis. Co-location is important to us.*

²⁰Adapted from LEM company profile.

²¹ibid.

Offshoring Production Capacity

Only 2 of the 36 investigated companies (**Datamars** and **u-blox**) did not maintain any production capacity in Switzerland. Of those two, Datamars, the animal and textile identification company through radio-frequency identification (RFID) chips, had gone through a deliberate offshoring decision, moving its entire production outside of Switzerland. The company was included in the research nonetheless, because at one time it did manufacture in Switzerland. Datamars maintained four production plants as of 2017. Only a few central functions, such as development, financial services, and central management, were still located in Switzerland, employing about 80 people.

In 2007, because of financial distress, **Datamars** decided to open a factory in Thailand. Management believed that unless they produced in a low-cost country, they could not stay competitive in the long run. Datamars made this site its sole production site for all electronic components. All third-party production in Asia, as well as the remaining production in Switzerland, was moved to Thailand, which also meant some layoffs in Switzerland. The strategy was to reduce the production costs, insource everything to achieve economies of scale and capture the value-added of the production. Production in Thailand started with 20 people and by 2018 reached an employment of 560, becoming the largest location within the Datamars group. Production was partly on standard machines and partly on specialized machines developed and refined in-house. In addition, the production process involved a certain element of implicit knowledge not easily copied. As a result of this move, Datamars was subsequently able to ‘fight on price and market share’ and squeeze out other small players.²²

Another big change in the **Datamars** production footprint came with the entry into the livestock tagging sector. Livestock identification was still dominated by ear tags with the RFID chips molded into a plastic tag. The importance of the injection molding process for this product line triggered the company to create its own plastic molding capacity as a key process, something the company had previously wanted to avoid.

Datamars established three sites in the world where their plastic injection molding was created: Texas, Thailand and a new factory in Slovakia. Because plastic parts, such as ear tags, are more bulky than electronic components, Datamars split the production into three different locations in order to reduce shipping costs. In addition, the implantable identifiers were assembled in Spain. In the livestock business, there were also local finishing sites in all the important markets where the tags were customized according to national requirements, to be delivered to customers within 24 hours.²³

u-blox represented the most extreme model of all companies, the firm never produced any of its chips or modules in Switzerland. When starting out in the late 1990s with its first commercial product, production had to be outsourced to an

²²Adapted from Datamars company profile.

²³ibid.

international supplier in Germany because the company had no production capability. As the business grew, the company remained with its “fabless” operation, although the entire process was directed from its Swiss location where a significant number of employees took care of research and engineering coordination, marketing and sales, and administrative functions.

u-blox did not produce any chips or modules. Chips were designed by u-blox and sourced from several fabs in different Far East locations. They were shipped to an integrator company, Flextronics in Graz (Austria), for final assembly and direct shipment to OEM customers. The role of u-blox was to design all products and to ensure quality. The company had designed its own quality control methodology, testing 100 percent of output. Full traceability of manufacturers and suppliers was arranged to manage any kind of risk, political or otherwise. A dedicated supply chain unit was operating from the company’s location in Thalwil, Switzerland. This unit, headed by Wyss, one of the three founders and also serving as COO of the company, consisted of about 30 employees. Its location in Thalwil was internally referred to as the ‘Silverhouse.’²⁴

Colocating Production

Reflecting on the patterns for production footprint, the companies that find it effective to operate from a single production location are more likely to remain anchored to their Swiss production sites. The single-site companies benefitted from the colocation advantage, whereas the multisite companies partially pursued a cost-driven location strategy for some of their output or, in some instances, followed their customers to provide superior delivery service. The majority of the companies found a way to combine superior production technology with differentiation of their products to justify producing from a higher cost base, such as Switzerland. The importance of colocating all activities on a single site was articulated by **Felchlin**, who invested CHF 20 million into a new facility to achieve this.

Due to the vision of the **Felchlin** founders, sufficient land reserves were available to centralize all of Felchlin’s activities on a single site in Ibach (SZ). After the expansion of the cocoa bean roasting facility in 2012, Felchlin began the process of planning and constructing an additional building that allowed for the entire company to be located on a single site. To do so, Felchlin planned to vacate the old villa and adjacent buildings to move next to the Ibach site. Management considered proximity and close communication to be of special value for a small business.²⁵

For many of the Swiss SMEs in our research sample, the colocation argument combined with exploiting the *Swiss made* label could compensate for the cost advantage of offshoring.

²⁴Adapted from u-blox company profile.

²⁵Adapted from Felchlin company profile.

Open Access This chapter is licensed under the terms of the Creative Commons Attribution 4.0 International License (<http://creativecommons.org/licenses/by/4.0/>), which permits use, sharing, adaptation, distribution and reproduction in any medium or format, as long as you give appropriate credit to the original author(s) and the source, provide a link to the Creative Commons license and indicate if changes were made.

The images or other third party material in this chapter are included in the chapter's Creative Commons license, unless indicated otherwise in a credit line to the material. If material is not included in the chapter's Creative Commons license and your intended use is not permitted by statutory regulation or exceeds the permitted use, you will need to obtain permission directly from the copyright holder.



The Role of Proprietary Processes

One of the questions pursued in researching the SME cohort in this study centered around the arrangements of the factory floor. Given that these SMEs were exporters, manufacturing or assembling products and competing with usually larger companies across the globe, the question about how a smaller competitor can compete on a smaller manufacturing base is, of course, a central one. In many cases, it was not only possible to discuss this question with company management, but also to *walk the floor* and get a visual impression of the environment. As it turns out, it is the proprietary processes which are of crucial importance to many companies and contribute substantially to a company's competitiveness. Again, there were different approaches about how best to arrive at this special position. For technologically and engineering-driven companies, it should not come as a surprise that sometimes ingenious solutions were adopted. Some of those solutions are described below.

Designing Proprietary Production Lines

First, there are those companies that adapted off-the-shelf production equipment into a proprietary production line that move beyond the capabilities of the standard supplied equipment.¹

- **Ricola** acquired its production equipment from external suppliers, particularly for the extraction method applied and then tied each step into a continuous flow. Processes were proprietary and developed internally. This meant that any potential competitor acquiring the same equipment from an external supplier would still not be able to arrive at the same end results.

¹Summaries based upon company profiles.

- **Fraisa** production processes were becoming increasingly automated. Production lines were equipped with a combination of purchased machinery, developed with partners and suppliers, and combined into a unique production line. None of the installations could be bought off the shelf.
- **Kuhn Rikon**'s plant in Rikon focused on its long-established cookware business. This product line, accounting for about one-third of total sales, was entirely produced in Rikon using a modern, custom-designed, and robot-enhanced production line.
- **Caran d'Ache** likened its manufacturing process for graphite, the "dough" for pencil cores, to "cooking, similar to pasta or baking bread." It involved 35 different steps and the company owned about 800 different pieces of manufacturing equipment, many designed internally.
- **Oetiker** did not see itself as the typical exporter with a Swiss base. Production activity in Horgen focused on core tools needed for the 12 foreign production operations. Key tools were required for the stamping operations, assembly tools, as well as for critical components in production machinery located at the various foreign production operations. Production equipment was proprietary and engineered, or adapted, by Oetiker for its own needs.
- **Medartis** employed titanium exclusively as the material for its implants, posing some special production challenges. Medartis machined its screws (not milled or cut with water jets). The company developed its production processes to the point where machining time in titanium was as short as it was for stainless steel screws or plates, leading to important savings through efficiency. Machinery was first sourced from Switzerland, but the company later switched to a German supplier who offered better service, including even on Sundays as is required when the company moved to a 24/7 operation.

The story that surfaced at **Sefar** was more involved and gives an idea about how a proprietary production line, one that operated with external equipment, evolves in order to make it difficult for any competitor to duplicate. Over the more than 150 years of the company's history, there is a consistent pattern of production process innovations and improvements, beginning even in the first phase, when processes from standard hand weaving looms were replaced by modern mechanical weaving looms situated in a plant. The process of improving Sefar's weaving plant, however, did not stop there and the company management went to great lengths to protect its *process knowledge*.

Sefar typically bought standard weaving machines as developed by weaving machine builders. Then, Sefar further optimized the machines with parts from local manufacturers so that, in the end, the equipment was 10 percent more efficient and produced better quality than when originally acquired. Sefar considered production as one of the company's success factors. It did not patent its improved weaving technologies, instead it tried to protect its process innovations by keeping them secret. A weaving machine manufacturer was never

allowed to enter Sefar's machine hall. When Sefar bought a new machine, the manufacturer had to unload it in front of the factory.²

SMEs, as creators of superior products, are well aware that copycats might always duplicate their visible features. However, if there is something proprietary in the production process and one that is closely tied to the end result, the company may be able to prevent copying. This required companies to become skilled in the production process design and, in a manner of speaking, invade the territory of their machine suppliers.

Building Custom Equipment

In some cases, companies went beyond stitching together purchased equipment and built their own equipment. This was a step beyond, toward proprietary production lines, and further protecting the production processes by making the equipment unavailable in the open market. **Bachem** initially produced peptides with equipment acquired from specialized, open-market suppliers. Over time, the company developed its own manufacturing processes based upon in-house intellectual property (IP).

Geistlich, also active in the life sciences field, found that it had to literally invent the entire production process.

At **Geistlich**, production processes for biomaterials differed radically from the previous industrial production model and had to be developed. Careful selection of bovine bones was required, and bone or collagen sourced exclusively from monitored establishments. Highly effective cleaning and purification processes were installed. The production processes were subject to regular inspections by various independent institutions and government authorities. End products were subjected to meticulous sterilization in sterile pressure chambers, not only for manufacturing but also for packaging. All products were subject to individual manual quality control at the Swiss plant. The Geistlich manufacturing process was enhanced through complete in-house integration of all important process steps, as well as the accumulation of a large number of patents that were granted on its original products. The combination of these approaches made it very difficult for potential competitors to enter this space and was a prime reason why Geistlich could achieve dominance in this field.³

Although Geistlich developed its production process by integrating each step, the company still had a number of product-related patents that provided additional protection from competition.

That a proprietary process can work even when patents have expired is documented by the experience of **Rüeger**, as a small player competing globally with its engineered temperature probes.

Once the patent protection expired, **Rüeger** did not experience any duplications or imitations. The reason had to do with the difficult manufacturing process required for its

²Adapted from Sefar company profile.

³Adapted from Geistlich company profile.

temperature probes. Rüeger, over the years, developed a unique manufacturing process based upon its own machinery and equipment. This equipment was not available on the open market as it had been custom built by Rüeger. As a result, the manufacturing process became a significant barrier to entry, which protected Rüeger beyond the patent protection time. The know-how required for the production process meant that the company produced all sensitive components in its plant in Switzerland and sent them to other locations for final assembly.⁴

For **maxon**, producing millions of high-performing electrical motors, a core aspect of production was its winding process for rotor manufacturing.

Winding machines were developed and made in **maxon**'s Swiss plant with a team of dedicated production engineers. The process was patented and the equipment was not available on the open market. The equipment was constantly modified and improved, reaching Industry 4.0 standard. Over time, the winding time of rotors was steadily improved from initially ten minutes, down to five minutes, later to one minute, and finally into the 12 second range with the latest generation of equipment.⁵

Developing winding machines internally meant that such equipment was not available on the open market, providing a significant protection against imitators or potential competitors.

Both **Oetiker** and **maxon** were also functioning as their own production line builders, combining proprietary production equipment with self-developed production lines at their head office plant in Switzerland and then shipping them to overseas production locations. **LEM** pursued a similar strategy in developing, piloting and engineering their production lines in Geneva and then making them available for their international production sites.

Installing Automation and Robotization

Many of the SMEs found that they needed to move increasingly into automation and robotization of their operations. The typical rationale was to escape the high labor costs incurred by the Swiss-based labor force. The adoption of process automation was usually undertaken step-by-step, rather than in one single, large fully automated production line. These are a few examples of this process.

- In 2017, **Ricola** produced 7 billion individual drops a year. The processes were highly automated.
- The production processes at **Fraisa** were becoming increasingly automated with equipment running 24/7, as well as on weekends, unattended.
- **Sylvac**'s Malleray site in the Jura focused on the hand-held measurement tools. Given that the company worked in small batches of lot sizes of 20 units, the

⁴Adapted from Rüeger company profile.

⁵Adapted from maxon company profile.

introduction of pick and assembly robots was intended to allow for output growth with stable staffing levels. Large assembly stations allowed for flexibility.

In several companies, the latest technologies, such as Internet of Things (IoT) have become commonplace, allowing companies to move into two- or three-shift production modes, while restricting the staffing to just one shift, work through weekends.

- At **Medartis**, a crew of about 75 was responsible to produce the entire Medartis portfolio on fully automated and robot-enhanced lines. The company operated on a 24/7 model with three shifts, with only one of those shifts being manned. IoT was implemented throughout. All relevant production and *process knowledge* was owned by Medartis.
- **Felco** operated an integrated production where every major step was brought in-house and all production was taking place under one roof, with the exception of its aluminum forged handles which were supplied by a separate subsidiary, which Felco also owned. Considerable investment was made into manufacturing automation across all production steps for parts manufacturing and, recently, even for some assembly steps. Only the final inspection remained a manual operation. Felco moved toward implementing Industry 4.0, providing regular status of all of its production machinery to the smart phones of supervisors. Applying the Five S methodology and SMED approach, it practiced TPM. The goal of all of this was to increase output while keeping its manufacturing staff at the same level.

How challenging it can be to move from old production methodologies to modern, automated ones, in addition to how to overcome the challenge of finding the best equipment suppliers, is demonstrated by **Filtrox**, producer of depth filters. Filtrox exemplifies how a company can, in a step-by-step process, move from mostly manually operated processes to automated ones and thus remain competitive from a cost point of view. The company management made sure that its manufacturing equipment would not be made available to competitors.

The basic method for the production of filter sheets has not changed over the last 80 years and was similar to the production of paper and cardboard. At **Filtrox**, this process was originally in the form of batch production. However, in the 1940s, Filtrox introduced a mechanical production process, using a second-hand machine from a paper manufacturer, which had to be converted to produce filter sheets. The wet production plant was then continuously developed further in an evolutionary process.

When the demand for filter sheets grew in the 1960s, Filtrox substantially increased production capacity, first by installing an enlarged sheet machine and, in 1972, expanding the sheet production line by enlarging the entire manufacturing plant. The new production line had a length of 72 meters and could produce six meters per minute. Subsequently, the production line was automated and improved considerably. In 2018, the entire line, the backbone of the whole company, could be run by a mere two people.

For **Filtrox**, it had always been difficult to find the right suppliers, because there were no standard machines for depth filter production. Furnace manufacturers and paper machine manufacturers were approached, and together with them, specific solutions for producing depth filters were developed. Frequently, the manufacturers had to sign a confidentiality and

exclusivity agreement preventing them from selling the developed solutions to Filtrox competitors. Not all manufacturers were willing to develop new solutions together with Filtrox instead of selling their own standard machines; it was typically niche players who became involved.⁶

Automating production processes allowed SMEs to remain cost-competitive. However, this could only be a sustainable strategy if the advanced engineering that went into these automation projects remained proprietary. At this moment, automation served the defense of cost competitiveness and allowed companies to grow production volume with a stable workforce.

Capitalizing on Long-Term Improvements

Experts have also observed that major competitive advantage comes from production or automation processes typically accrued from improvements that have taken place over an extended period of time and are based on extensive experience. Such improvements are not mere productivity gains based upon superior engineering but skill-based improvements that are extremely difficult to duplicate for outsiders. These long-term improvements, which subsequently become part of a company's manufacturing know-how, were observed at several of the researched companies, such as **maxon**, **Caran d'Ache** and **Rüeger**.

Open Access This chapter is licensed under the terms of the Creative Commons Attribution 4.0 International License (<http://creativecommons.org/licenses/by/4.0/>), which permits use, sharing, adaptation, distribution and reproduction in any medium or format, as long as you give appropriate credit to the original author(s) and the source, provide a link to the Creative Commons license and indicate if changes were made.

The images or other third party material in this chapter are included in the chapter's Creative Commons license, unless indicated otherwise in a credit line to the material. If material is not included in the chapter's Creative Commons license and your intended use is not permitted by statutory regulation or exceeds the permitted use, you will need to obtain permission directly from the copyright holder.



⁶Adapted from Filtrox company profile.



Designing for Durability

Designing and constructing superior products is expected to go hand in hand with creating products that work faster, offer greater precision, perform more functions, work more reliably, last longer, and are increasingly productive—all issues generally related to quality. Swiss SMEs lived up to many of these performance requirements. **EAO**'s push buttons, for instance, are engineered to sustain over 10 million touches over their lifetime. In terms of benefits delivered by their product, **Felco** had a very special way to determine it and thus operationalize quality.

At **Felco**, durability was a requirement for long-term use. Felco products were made to be turned over from generations to generations rather than to be disposed of soon. To achieve durability and allow the company to issue a life-long guarantee, only the most exacting manufacturing processes and materials could be used. Company values supported the creation of the best possible pruning products. Precision in cutting, or pruning, also guaranteed “quick healing of the pruning wound” resulting in better yields for the farmers.¹

In several instances, the researched companies added functionally enhanced design, or styling, that heightened their product's visual appeal. There is an additional element that comes through across our sample and, in some instances, makes the difference in a product's ultimate success—focusing on the actual end customer and how easy it is for them to use the product. This is sometimes also referred to as ergonomics. Felco's approach to ergonomics is addressed later in this chapter.

As mentioned, an important feature of the **EAO** push buttons is that they are engineered to sustain over 10 million touches over their lifetime. However, it was the attention the company management paid to the user that heavily influenced the company's product design concept.

¹Adapted from Felco company profile.

The **EAO** team proposing a new product was tasked to put five core value propositions on a single page and not to create a large book of technical specifications. The key questions to be answered were: “Who is pushing the button?” and “Why is this person pushing the button?” The user’s task and the user’s experience were always at the core of new products, ever since the two founding pioneers started **EAO**.²

Designing with Flair

Visual design is at the core of many of the B2C products which require superior design features to compensate for the higher costs of Swiss-made products. Such design superiority can be observed with **Kuhn Rikon** kitchen utensils and cooking pots and with **Caran d’Ache** pencil sets. In 2018, the Swiss government awarded **Felco** the Swiss Design Award for its distinctive red-handled products. With its textile products, **Lantal** was also using superior design to compete in its marketplace. Pictures of these products are depicted in some of the company profiles. The extent to which companies concentrate on design is best illustrated by the process undertaken at **Jura** and the role company management played in supporting it.

Design was at the core of **Jura**’s strategy. The company was at the forefront of detecting a trend where coffee machines became an aspirational product for high-end customers. Modern kitchens increasingly became an open area and an attractively designed coffee machine would be part of the total look. All features of **Jura** machines were originated, controlled and driven by the company. Its CEO, **Probst**, played the leading role in this process as he frequently travelled to international sites. He was fond of visiting automobile shows and he appears to have been influenced by modern auto design features. The **F90** model launched in 2000 was considered the model that most defined the design of future **Jura** machine generations.³

Ergonomics, Broadly Defined

The interpretation of ergonomic principles, adopted by some Swiss SMEs, is broad. It not only includes product usage but also goes all the way to include maintenance and the corresponding design for ease of maintenance. At **Felco**, product ergonomics was defined from the user’s point of view. This perspective was clearly defined, operationalized, and then translated into a superior product, which was in competition with products a third of its price.

In vineyards, plants had to be pruned during a limited time window, with professional pruners in large vineyards performing thousands of cuts a day. As a result, **Felco** pruners could withstand 10,000 cuts a day without causing injury to the user’s hand. Comfort in the pruner’s hand, as well as having a minimum weight and a spring for effort reduction, were critical. To achieve the best ergonomics possible, **Felco** offered products with differently

²Adapted from **EAO** company profile.

³Adapted from **Jura** company profile.

shaped handles, for different hand sizes and for left- or right-handed pruners, as well as handles that could tilt during the pruning action.⁴

The effectiveness of the principle of being user-friendly through ease of maintenance and operation was also demonstrated at **Thermoplan**, producer of fully automatic coffee machines, whose initial success came from solving a persistent problem in hotel and restaurant kitchens. In fact, the company applied the principle of ergonomics in three consecutive scenarios to propel itself into becoming a leading supplier of automated coffee machines for professional use.

Starting out in the kitchen installation business, **Thermoplan**'s founder Domenic Steiner regularly attended industrial fairs that attracted hotel and restaurant kitchen designers and operators. During his many exchanges with other fair visitors, Steiner learned that one of the notoriously difficult elements of any restaurant kitchen was the cream whipping equipment. As he had installed many of them himself, he knew them to be bulky, difficult to clean and with kitchen operators complaining that they were often a stumbling block to pass food inspections. Clearly, whipping cold cream was a 'pain point' for restaurant and hotel owners. This made Steiner look for a team to solve the problem. Together with a local mechanical workshop, known for its tinkering mindset and skills, they solved the aeration problem and in 1983 brought a cold cream whipping device on the market half the size of existing equipment, considerably more user-friendly, easy to clean and allowed for connecting a TetraPak cream container. This simple device branded 'S'Whipper' conquered the world. Within a few years, the company was represented in 60 countries.⁵

The success of **Thermoplan** leads to two more new product ideas that were both based on the idea of simplification, ease of use, and ease of maintenance for hot milk, lattes, and cappuccino coffees.

Launched in 1993 under the brand name of 'Faomino,' Thermoplan's new equipment was designed based on the same ease of use and maintenance principles as its cold cream whipper. In a short period, Thermoplan became global market leader for automatic milk foam production as required for the ever-growing popularity of cappuccino coffees and lattes in the US. As a result of its success, Thermoplan's name became associated the world over with hot milk foam.⁶

From there on, it was just one more step to design and launch a fully automatic espresso machine that would operate on the ease of use principle, for example, at the push of a button, easy to maintain and include both the cold cream whipper and hot milk foamer as modules. Up to that time, espresso coffee was prepared using Italian espresso machines that required several manual steps and an experienced operator. It was the same principle of ease of use, or coffee at the push of a button, that Jura had applied earlier for its in-home espresso machines.

⁴Adapted from Felco company profile.

⁵Adapted from Thermoplan company profile.

⁶ibid.

The principle of ease of use was further perfected by **Pilatus** regarding the world of *ease of flying* and *ease of maintenance* for executive and private planes. In its first 20 years of existence, Pilatus had largely produced training aircraft for military pilot training. In 1957, the company commenced the development of a small, all-metal, rugged transporter for civil use branded “Pilatus Porter PC-6.” Its major differentiator was the short takeoff and landing capabilities (STOL) for operation from unpaved and rough airstrips in remote areas. The rugged airframe was designed for low maintenance. Its simple structure allowed for repairs in the field. The highly energy-absorbent undercarriage with low-pressure tires allowed the plane to operate from more rugged terrain. Capitalizing on this experience, Pilatus began design work on a new civil aviation model named PC-12.

Conceived by **Pilatus** as the first single-engine light plane equipped with a pressurized cabin that could seat up to nine passengers and cover distances as long as 3,500 km, the PC-12 was to turn into a major success with over 1,700 deliveries since 1994. The PC-12 retained some of the takeoff and landing capabilities of the PC-6 with the ability to operate from unpaved airstrips. Specially designed landing gear arrangements allowed the PC-12 to utilize a large number of airfields most executive planes would be otherwise excluded from. Certified for single pilot operation, the PC-12 became the plane of choice for owner-flown executive pilots. The PC-12 was designed for ease of maintenance with the layout of the engine and other key parts easily accessible to mechanics for repair or replacement.⁷

Two elements stand out: first, designing the PC-12 so that it could be operated by one pilot, allowing licensed executives and business owners to fly without a professional pilot and, second, the construction allowing for ease of maintenance, reducing the operating costs on a flight-hour basis below that of other, lower-cost planes. These design principles were carried out once more into the launch of the PC-24, which was an executive jet that retained all of the elements related to ease of flying from the previous PC-12 model series. This was Pilatus’ first jet engine model. The prototype made its maiden flight in 2015, and the final certification was completed in 2017. First deliveries were made in 2018.

The **Pilatus** PC-24 cockpit was laid out for two pilots. The Advanced Cockpit Environment reduced the pilot workload to the extent that it allowed for single pilot certification. Single pilot certification meant that executives could use the plane for business purposes and, if certified, could use themselves and were not required to hire a professional pilot, substantially reducing hourly operating costs below competitive models. Up to that point, executive jets were typically flown by a professional flight crew of two.⁸

⁷Adapted from Pilatus company profile.

⁸ibid.

Design Thinking by Tradition

The principles followed in the design concepts of these Swiss SMEs are deeply rooted in their operational philosophies. Modern management literature is full of references to *Design Thinking* as a methodology for approaching winning product design.⁹ Many of the Swiss SMEs in this study preceded this management concept and had adopted it long before a name for the process was created and popularized. The design ideas for **Pilatus** executive jets, the **Thermoplan** coffee machines, and the **Felco** pruning shears could all make excellent examples in a *Design Thinking* workshop offered by many consultants today. These companies institutionalized the concept of *looking over the shoulders of their customers* a long time ago and perfected the results to their own benefit, thus adding value to their products and achieving premium prices on global markets. They are Design Thinkers!

Open Access This chapter is licensed under the terms of the Creative Commons Attribution 4.0 International License (<http://creativecommons.org/licenses/by/4.0/>), which permits use, sharing, adaptation, distribution and reproduction in any medium or format, as long as you give appropriate credit to the original author(s) and the source, provide a link to the Creative Commons license and indicate if changes were made.

The images or other third party material in this chapter are included in the chapter's Creative Commons license, unless indicated otherwise in a credit line to the material. If material is not included in the chapter's Creative Commons license and your intended use is not permitted by statutory regulation or exceeds the permitted use, you will need to obtain permission directly from the copyright holder.



⁹Brown T (June 2008) Design thinking. *Harvard Business Review* 85–92; Brown T, Katz B (2009) Change by design: how design thinking transforms organizations and inspires innovation. Harper Business, New York.

How SMEs deal with product line depth versus breadth requirements and, in particular, how they manage to maximize product variations, which increase the number of SKUs,¹ are a big challenge for all companies, large and small. For small companies with limited resources, the challenge is even bigger.

Adopting Modularization Strategies

Although Swiss SMEs, in general, follow a type of focus strategy, they have nevertheless found a way to offer the maximum amount of product variations, or models, in their chosen segment or market space. This poses a particular pressure on efficiency because companies are dealing with a large number of SKUs and a limited production volume at the same time. Modularization strategies, in combination with platforming, are used extensively to allow an efficient way to offer choice, as well as provide customers particular forms or models. Modularization strategy is a potent defensive strategy for Swiss SMEs against large, international competitors who typically offer a more limited choice in a given market space.

LEM, as a volume producer of high-quality products on automated production lines, combined skilled assembly and testing. Its product line was comprised of more than 2,000 separate models with prices ranging from a low of CHF 1.00 per unit to CHF 1,000 or more for selective components. Outsiders estimated the output at more than 50 million units.²

Although it was primarily the larger SMEs with electronic products, such as LEM, and components that availed themselves of the modularization, even smaller companies, such as **DC Swiss**, producer of specialized threading tools, used the approach to bridge depth of choice with efficiency.

¹Stock keeping unit.

²Adapted from LEM company profile.

DC Swiss operated two manufacturing sites. The main site in Malleray produced all finished tools and a second site was opened in Bevilard producing tool blanks only. Between the two sites, the company produced more than 5,000 tools daily, or about 1 million tools annually. DC Swiss tracked several thousand SKUs, of which the majority were considered standard. The company operated a modern and flexible machine park with many CNC machines for grinding tools to specifications. The marketing process was supported by an on-line tool shop and catalog that also contained a tool finder program for on-line search. This on-line channel had been constantly growing. Intensive use of the YouTube channel was also made with specific videos explaining the many different types of tools.³

At **DC Swiss**, the production process took place in two steps, beginning with tool blanks produced in large numbers and to be made later to specific requirements. The tool blank is the platform, the ability to machine thousands of product versions from it brings in modularization: to manufacture a large variety of items from a number of basic, modular choices.

The increase of product line depth—offering a large variety of products aimed at the smallest use variations—also causes challenges for customers. The development of product finder programs, as indicated by DC Swiss, is therefore a recurring topic among companies. Many of them are in the midst of launching such internet-based programs accessible only to their customers.

Employing Platforming Strategies

At **Komax**, maker of cabling machinery marketed into a number of industry user segments, the cabling technology became the platform around which a large number of model variations were created providing customer choice and leaving Komax with flexibility in the production process.

As **Komax** segment choices evolved over time, so did the complexity of its product line. At the outset, emphasis was on the functions performed by its equipment. Starting with wire stripping, crimping, and cutting and crimping, and then moving on to crimping to crimping, twisting and into harness manufacturing, the company's range of functions performed steadily increased. These functions were offered in either freestanding equipment or as modules that could be plugged into larger systems. In parallel, Komax was offering different product platforms by scaling the desired level of automation, ranging from 'essential' to 'advanced', to 'top of the line.'

Leveraging modularity around its core product platform, **Komax** built a large portfolio of equipment for each of the various functions. For wire stripping, eight different model families with different complexities, ranging from single wire to multiple wires, and different types of stripping technologies, were offered. For wire crimping, three presses were offered with increasing level of automation and complexity. The cutting and stripping operation, as well as the crimping to crimping function, were served with eight machine models each. For harness manufacturing, four machine models were in the product line, and two for wire marking. For wire handling, as many as 12 models were part of the product line. Additional products were offered for quality control, process control and service.

³Adapted from DC Swiss company profile.

Concerning platforms, or systems, these equipment modules were combined as needed and could be engineered to specific customer requirements.⁴

While the number of product combinations at Komax was limited to various machine models, the choices literally exploded once it was applied to electronic components. **u-blox**, producer of positioning communication modules and chips, started with a small set of products to embark on creating an ever-expanding product platform.

Initially, **u-blox** developed a first surface-mounted GPS receiver which was accomplished in the second year of the company's creation. After this first product, the company developed modules from purchased chips that could be integrated into different kinds of devices in need of communicating positioning information using the GPS. Over time, u-blox improved its products from one generation to another, constantly offering ever smaller form factors, reducing the amount of energy required and lowering costs for the user. Its products are offered in many different combinations and could be engineered to the specific requirements of a customer.⁵

At **maxon**, the application of modularity and product platforming reached even higher levels of combination.

Ever since the introduction of its first motor, **maxon** consistently introduced new product families with ever better and ever more efficient motors. The company built an extensive, modular product line where products could be configured from a website using available components. Actual configurations ranged from 12,000 to 15,000 variants, but theoretical combinations were "in the billions." The maxon product line covered motors which typically consisted of 30 to 70 components. Gears comprised another 20 to 50 components. Then there were controllers and sensors made up of several different technologies. Part of the maxon product line were accessories and ceramic components. All of these components and products were accessible to engineering designers through an online system allowing custom-specific configurations. Finally, the maxon mechatronic drive systems product line was built around the fact that such systems worked only if all components were perfectly synchronized. maxon was able to combine its product elements by integrating them into a mechatronic system resulting in a compact design and components configured for the customer's application.⁶

Although smaller in sales than maxon, **EAO** developed into a champion of modularization amassing about 15,000 individual components from which customers could compose their HMI products.

The entire **EAO** HMI model range consisted of a large number of variations and was built on the basis of about 15,000 individual components. From this large number of components, the number of possible combinations went into the millions. While not all theoretical combinations were in use, the possibilities were such that the company needed to assist customers in configuring their requirements. To address this complexity issue, EAO

⁴Adapted from Komax company profile.

⁵Adapted from u-blox company profile.

⁶Adapted from maxon company profile.

launched a digital catalogue, web-based and computerized, to make it easier for customers to select the right combinations. Some 30 percent of EAO sales were for customer specific combinations.⁷

The **EAO** product overview listed the following categories, from which different combinations were possible:⁸

- 24 different basic button types.
- 18 different functions provided (indicators, buzzers, etc.).
- Two types of designs (flushed, raised).
- 11 different protective designs.
- Eight different VAC ratings.
- Seven different mountings cutouts (diameter sizes, in mm).
- Nine different connection terminations (soldiering, etc.).
- Four different lens materials (aluminum, etc.).
- One form of markings (laser, engraving).
- 15 different approval standards (UL/UR, etc.).

The top seller among EAO products was the sound buzzer inside the seat belt closure to prompt the driver or passenger to put on their seat belt. Launched in 1996, the company was selling about 22 million units annually. EAO sold annually about 30 million human machine interface (HMI) units globally.

Combining Modularity with Platforming

The smallest company in the sample, **DC Swiss**, and one of the largest, **maxon**, are both featured in this chapter. That a larger company such as maxon was able to deal with an extensive product line and remain focused in purpose should not be surprising. That the smallest firm managed equally to go to market with an extensive line does raise questions about how this could be accomplished while staying competitive. How then do small firms manage to remain competitive globally under those circumstances?

The answer lies, as was pointed out, in the combination of applying modularity to the product line and in scaling this modularity into platforming to arrive at infinite variations in order to satisfy every possible client need. **DC Swiss** achieved this in a modular production process building upon basic, blank tools and postponing final design until later. This requires both great manufacturing skills and flexibility. Larger firms, such as **maxon**, and **EAO**, source many small components according to their specifications from multiple suppliers and assemble an infinite variety of possible end products. This requires a well-functioning supply chain that can depend

⁷Adapted from EAO company profile.

⁸ibid.

on many suppliers for different, engineered parts. By adopting these principles of modularity in combination with platforming, the SMEs in this research achieved efficiencies that otherwise were reached only by much larger companies relying on volume production. It was essential for the companies to follow the cramming principle pursued in their segmentation strategies as described earlier in Part V. How this impacts on requirements for supply chains is covered in the next chapter.

Open Access This chapter is licensed under the terms of the Creative Commons Attribution 4.0 International License (<http://creativecommons.org/licenses/by/4.0/>), which permits use, sharing, adaptation, distribution and reproduction in any medium or format, as long as you give appropriate credit to the original author(s) and the source, provide a link to the Creative Commons license and indicate if changes were made.

The images or other third party material in this chapter are included in the chapter's Creative Commons license, unless indicated otherwise in a credit line to the material. If material is not included in the chapter's Creative Commons license and your intended use is not permitted by statutory regulation or exceeds the permitted use, you will need to obtain permission directly from the copyright holder.





Models of Supply Chain Integration

Ever since the publication of Porter's seminal book *Competitive Strategy*, companies have become concerned with integration operations and their supply chain choices.¹ Should a company remain in manufacturing, and how far backward or forward should a company be integrated? Both are questions that management practitioners debate. The same applies to the management of the supply chain; to what extent can a company rely on suppliers for raw materials, parts, and components? As a result, the practices of the SME sample companies have been analyzed in light of these questions, in order to see whether there are any discernible patterns.

Of the 36 companies researched, all but 2 (**u-blox** and **Jura**) directly engaged in manufacturing to varying degrees. That means these companies all owned manufacturing assets, some of which might be located outside of Switzerland. For the purpose of this section, any manufacturing assets, owned anywhere, were taken as an indicator of manufacturing activity.

The extent of being involved in manufacturing stretched from fully integrated operations to assembly only, with some companies in the mid-range of integration employing a mix of activities. For the purpose of this analysis, it was therefore differentiated between the following categories (the authors' own terminology):

- The Integrators
- The Partial Integrators
- The Assemblers
- The Outsourcers/Fabless

¹Porter ME (1980) *Competitive strategy*. Free Press, New York.

Depending upon the extent of manufacturing integration, the companies also used their sourcing strategies for components, or subassemblies, to hedge against currency risks.

The Integrators

SMEs who operated in a fully integrated mode, covering all major steps of the manufacturing process internally, could be found in various industries. They included those firms attached to primary resources from agricultures, or other resources difficult to access, as well manufacturing companies with unique processes.

Early in its history, **Ricola**, the producer of herbal drops, expanded up the value chain as a way to ensure its supply of herbs, the key raw material for its products. The backward integration into herbs also impacted the logistics of warehousing and storage at the company's processing center in Laufen.

By the early 1980s, the success of **Ricola** sales began to outstrip its supply of herbs, which up to that time came mostly from the local area. The company launched an appeal to Swiss communities and schools, with disappointing results. Eventually the company connected with over 100 contract herbal farmers in the Swiss Jura and mountains, encouraging them to plant the herbs on contract. Ricola provided the seeds to the farmers. The total plantation area amounted to an equivalent of about 124 football fields and yielded 1,400 tons of fresh herbs each year. Herbs were dried immediately in the various mountain regions, then put in bags and shipped to the Ricola herb center for further sorting, drying, cleaning, and mixing with other ingredients. Each year, Ricola processed about 250 tons of dried herbs.²

Equally involved into sourcing its raw material was **Felchlin**, the chocolate couverture producer. This involvement was central to the company's strategy that relied to a large extent on processing selective cocoa beans not otherwise available on the world market. Felchlin's differentiation from major competitors rested on this practice.

Traditionally, the industry had treated all cocoa beans as being the same, essentially as a commodity. Aschwanden and his team at **Felchlin** decided to take a page out of other industries and develop a chocolate product line made from distinct, labeled and identified beans, such as was the case in the coffee industry. The Felchlin team went back to the roots of cocoa to identify special growers in South America who were small-lot farmers organized into cooperatives. This avoided the child labor issues, and Felchlin paid 10 percent above going fair trade prices. The resulting Grand Cru Selection consisted of single origin couverture, similar to single malt spirits.³

²Adapted from Ricola company profile.

³Adapted from Felchlin company profile.

Although sourcing was important, it was not sufficient for Felchlin's competitiveness. The manufacturing process, too, had to be designed and controlled to guarantee the right product composition and consistency.

All processing steps to arrive at the chocolate were made by **Felchlin** in its fully owned operation. Cleaning, roasting, milling, kneading, rolling and conching were the steps performed internally to meet the highest levels of fineness. Milk was sourced from the special UNESCO biosphere Entlebuch in Switzerland. After the expansion of the cocoa bean roasting facility in 2012, Felchlin began the process of planning and constructing an additional building that allowed for the entire company to be located on a single site. Felchlin planned to vacate older buildings to move next to the Ibach site. Management considered proximity and close communication to be of special value for a small business. The investment of the last building expansion was budgeted at CHF 20 million.⁴

Geistlich, the pharmaceutical company producing bone substitutes from natural materials, also found itself in a situation where control of the raw material was central, and the follow-on processing dictated a completely integrated manufacturing process.

At **Geistlich**, the production processes for a biomaterials company differed radically from the previous industrial production model. Careful selection of bovine bones was required, and bone or collagen was sourced exclusively from monitored establishments. Highly effective cleaning and purification processes were installed. The production processes were subject to regular inspections by various independent institutions and government authorities. End products were subjected to meticulous sterilization in sterile pressure chambers, not only for manufacturing but also for packaging. All products underwent individual manual quality control at the Swiss plant. This clean room environment differed radically from the environment of the old bone processing plants. The Geistlich manufacturing process established for the purpose of entering biomaterials was enhanced through complete in-house integration of all important process steps, as well as the accumulation of a large number of patents that were granted on its original products. The combination of these approaches made it very difficult for potential competitors to enter this space and was a prime reason why Geistlich could achieve dominance in this field.⁵

Among the manufacturers, **Felco** was an example of a completely integrated manufacturing company with most production steps being controlled internally.

Felco followed the policy of bringing key production steps in-house. As part of this strategy, Felco became the sole shareholder of Prétat in 1997, the only company specializing in aluminium forgings in Switzerland. Since nearly all Felco products came with forged aluminium handles, the acquisition of Prétat was of great strategic value. Prétat did half of its business as a captive supplier to Felco. The rest was with other customers, many of them outside of Switzerland. The company was founded in 1947 and had about 65 employees.⁶

⁴Ibid.

⁵Adapted from Geistlich company profile.

⁶Adapted from Felco company profile.

A high degree of integration was maintained among most of the manufacturing companies. Some, such as **DC Swiss**, **Fraisa**, or **Medartis**, would acquire raw materials and produce the final product in-house. There the raw materials were more of a standard type, such as different metals or types of steel, that were available on the open market. Differentiation was accomplished through the conversion into the final product, not so much from unique source materials.

The Partial Integrators

Several companies pursued a mix of sourcing versus self-production, insourcing semi-manufactured parts, and combining this with manufacturing the critical elements. In the case of these firms, differentiation was gained from preserving the difficult steps in manufacturing key components internally. The examples of **Rüeger** and **Sylvac** are highlighted below.

The **Rüeger** product line expanded considerably beyond its original temperature gauges. To the bimetallic temperature gages were added gas thermometers, HVAC temperature gauges, thermometers for marine diesel applications and thermo wells. More complex products added were temperature probes with transmitters, or multipoint sensors for use in many types of reactors. Temperature gauges represented more than 80 percent of company sales. Related to temperature instruments was a line of pressure gauges. And finally, the company also produced instruments on an OEM basis used mostly in the food industry. All of those products leveraged Rüeger's core technology. In its application space, Rüeger offered one of the most extensive and differentiated product lines. Some of these products were manufactured in large volume on automated or robotized lines, which allowed them to be produced in Switzerland.⁷

Sylvac had moved to insourcing basic caliper blanks from abroad to perform the more difficult finishing tasks, including mounting electronics, internally.

Concerning **Sylvac**'s calipers products line, the company sourced blank calipers and finished them. Given that the new rules surrounding Swiss-made required that 60 percent of the value-added, exclusive of R&D input (S/W), originated from Switzerland, Sylvac had to change its documentation for the calipers' product line. According to management, all catalogs had to be changed to eliminate the Swiss flag. Since the company image remained Swiss, this was not viewed as a big problem in marketing.⁸

Plumettaz produced in Switzerland and sourced most components locally. However, the Chinese sales subsidiary was also a source for some components produced in China, a practice that had been pursued by other companies as well.

Plumettaz's production facility and equipment was constantly updated and increasingly automation was used to remain efficient with a relatively complex product line. Most

⁷Adapted from Rüeger company profile.

⁸Adapted from Sylvac company profile.

production and sourcing were concentrated in Switzerland, with the Chinese subsidiary assisting in the sourcing of some components.⁹

Even when a production was completely moved abroad, as was the case for **Datamars**, the presence of a fully integrated manufacturing operation offered a competitive advantage. With the permanent expansion to Asia, Datamars became the only vertically integrated company designing and producing all key components of RFID solutions for the companion animal and textile identification markets.

The Assemblers

A few companies are specialized in the assembly stage of their operations, sourcing key components from a large number of local, sometimes international, suppliers. These companies sourced engineered parts or components, made to specifications of their own design, from extensive networks of suppliers. Both **Thermoplan** and **EAO** were following this strategy.

When **Thermoplan** was ramping up logistics, and production required to meet Starbucks' massive orders of thousands of coffee machines annually, the company benefited from its sourcing strategy. From its inception, the company had relied on local suppliers in Switzerland for its components, made to specifications as per Thermoplan engineering designs. Value chain activities at Thermoplan concentrated on purchasing components, assembly of machines, quality assurance and distribution via distributors, as more than 90 percent of its sales went into exports.¹⁰

The benefit of **Thermoplan's** strategy to concentrate on assembly only resulted in a more flexible production system in terms of volume, in addition to reducing the investments required to ramp up.

Within five years of receiving the Starbucks contract, **Thermoplan** sales had passed CHF 80 million and employment reached 130. By 2008, sales had doubled again to reach about 150 million and employment surpassed 200. Headcount of dedicated staff at component supplier companies were estimated to have surpassed 300. The level of 20,000 annual machines sold was reached in 2013.¹¹

To protect its proprietary designs for its coffee machines, Thermoplan controlled component design. The company achieved a significant degree of protection in terms of its competitive advantage, which rested on design and construction but not a particular manufacturing process.

Thermoplan constantly adapted its production system. The entire logistics system was fully automated. Difficult and complex to manage, the production system and machine design had

⁹Adapted from Plumettaz company profile.

¹⁰Adapted from Thermoplan company profile.

¹¹Ibid.

to be re-engineered for lower cost. For management, it was important to keep assembly and production in Switzerland as quality advantages outweighed potential cost disadvantages. Thermoplan could claim Swiss quality and *Swiss made* for its equipment. For OEM partner machines, the name Thermoplan did not appear, only the Swiss cross did. As sales grew, Thermoplan had to continuously enlarge its production capacity. In 2005, the company broke ground for its third factory expansion. In 2014, came the fourth factory expansion and an additional 50 jobs. A major logistics center was planned for 2020.¹²

EAO followed a similar strategy of concentrating on downstream activities while tightly controlling the costs and quality of its supply network.

The large number of elements at the basis of **EAO**'s modularized product platform with almost unlimited combinations required a dedicated value chain in line with the product line configurations. EAO did not produce its own plastic injection molding and metal stamping components. Instead, the company focused on four core value generators, on (1) product development with customers, (2) a dedicated expert supplier network, (3) automated assembling with in-line quality testing and (4) its worldwide sales and customer service network. The product parts were sourced from specialized suppliers, the majority from Switzerland or Germany. The all-important plastic components were sourced from Swiss injection molders. As a heavy user of tools and molds needed for its plastic material converters, EAO owned most molding tools, stored with suppliers for their use. Transferring these tools abroad would be slow. Consequently, plastic conversion operations and mold suppliers were largely based in Switzerland.¹³

The aircraft manufacturer **Pilatus** could also be categorized, to a large extent, as an Assembler. What mattered in the case of Pilatus was the fact that key components, such as avionics or aircraft engines, were sourced from USD currency-denominated suppliers, the USA in particular, providing a partial hedge in the case of the all-important CHF versus USD currency valuations.

Pilatus: Over the years, as the Swiss Franc began its steady rise compared to the USD or the Euro, the company maintained a considerable sourcing operation from local suppliers and subjected parts to a rigorous cost reduction engineering process. The sourcing of avionics systems and engines from North America helped partially with the currency exchange pressure.¹⁴

What is noteworthy for the Assemblers is their emphasis on exclusively engineered, designed, and quality controlled in sourced components, as well as on marketing and sales activities.

¹²ibid.

¹³Adapted from EAO company profile.

¹⁴Adapted from Pilatus company profile.

The Fables Two

Two of the researched companies, **Jura** and **u-blox**, did not own any manufacturing or even assembly facilities. Instead, they have outsourced this activity to a third party. In many ways, their business systems are similar to that of the Assemblers, except that they do not engage in assembly activities. The starting point for the two differs, but the end result is the same.

At **u-blox**, the company never did have any manufacturing capability and always had to source its products from external suppliers, as was covered in a previous section.

u-blox did not produce any chips or modules. Chips were designed by u-blox and sourced from several fabs in different Far East locations. They were shipped to an integrator company, Flextronics, in Graz (Austria) for final assembly and direct shipment to OEM customers. The role of u-blox was to design all products and to ensure quality. The company had designed its own quality control methodology, testing 100 percent of the output. Full traceability of manufacturers and suppliers were arranged to manage any kind of risk, political or otherwise. A dedicated supply chain unit was operating from the company's location in Thalwil, Switzerland.¹⁵

Several elements of **Jura**'s business strategy were instrumental in achieving rapid a growth and global expansion. Examining the key elements that contributed most to **Jura**'s success, the observer is struck by the company's focus approach which took place at several levels, from the product line, the marketing segment, the value chain, its branding strategy, its innovation approach and its sales and service models. In each of these areas, the company could be observed focusing further on particular subtasks within each element. A brief explanation of this process follows.

Jura CEO Probst was fond of saying that *No one can possibly run the entire distance alone and expect to reach their goal. There are runners for every stage of the journey.* Using this analogy for **Jura**, he concluded that the company could not, on its own, design and launch a new line of espresso machines while at the same time ramping up production. As a result, **Jura** entrusted the production of its new automatic espresso machines to a partner, Frismag, located in Eastern Switzerland, to become its exclusive contract supplier. But, supplier only, as product design and downstream marketing strategy remained the full responsibility of **Jura** and its staff. Frismag, a company larger than **Jura** with more than 2,000 employees, was shouldering the entire production capacity investment leaving **Jura** to use its resources for the downstream steps of its value chain.¹⁶

Delegating the production of its espresso machines, **Jura** could concentrate on the key steps of the value chain it considers most important and for which the company had both the talent and the resources: design and downstream marketing.

¹⁵Adapted from u-blox profile.

¹⁶Adapted from **Jura** company profile.

All features of **Jura** machines originated, were controlled and driven by the company. Its CEO, Probst, played the leading role in this process as he frequently travelled to international sites. He was fond of visiting automobile shows and he appears to be influenced by modern auto design features. The F90 model, launched in 2000, was considered the model that most defined the design of future Jura machine generations.¹⁷

Beyond its design, partners were chosen for selective features, or elements, of its coffee machines. One was for the water filtration mechanism installed in every Jura machine.

Jura's supplier and partner, Acquis, a Swiss-based filtration specialist, designed the CLARIS filter cartridge especially for **Jura** machines in such a way that the resulting coffee quality would be consistent, independent of the water source used. Jura did not believe that it made sense to develop its own filter. Instead, the company aimed at collaborating with the best in the field and having that partner produce a custom-made filter for its machines. The same approach was used for other machine elements. The role of design was also core to Jura's strategy. The company was at the forefront of detecting the trend of coffee machines becoming an aspirational product for high-end customers.¹⁸

Jura had originally produced all of its home appliances and moved to a focus on design and marketing only later in its history; the company offers an example of extreme, or multilevel, focus. Not only did the company focus on a unique market space, namely the automated espresso machines for home use in the top-line segment, but it also honed in on the value chain concentration—the key tasks of designing and marketing. This represented a form of focus on multiple levels and allowed the company to concentrate its resources on a very narrow set of activities, or tasks, aimed at a very narrow market segment. At **Sécheron**, management referred to this approach as “task focus.”

Reflections

The experience of the 36 SMEs demonstrates the importance of manufacturing in the firm's ultimate success. The vast majority, in fact 34 of the firms, owned their manufacturing assets even though their involvement could be anywhere from full integration to assembly only. The extent of manufacturing integration depended on the importance of proprietary production steps. If the proprietary steps were less important, or if there were no particular manufacturing skills involved, the companies moved toward assembly only or, in two instances, availed themselves of external contract manufacturers. When the latter was the case, the companies tightly controlled the engineering, quality, and design functions, while the sourced manufacturing components, or elements, remained proprietary to the originating company. As companies moved toward the lower end of the value-added chain

¹⁷Ibid.

¹⁸Ibid.

activities, the role of marketing increased versus that of engineering, design, and quality control, as did the necessary skill sets. All of the companies maintained a close connection to production.

Open Access This chapter is licensed under the terms of the Creative Commons Attribution 4.0 International License (<http://creativecommons.org/licenses/by/4.0/>), which permits use, sharing, adaptation, distribution and reproduction in any medium or format, as long as you give appropriate credit to the original author(s) and the source, provide a link to the Creative Commons license and indicate if changes were made.

The images or other third party material in this chapter are included in the chapter's Creative Commons license, unless indicated otherwise in a credit line to the material. If material is not included in the chapter's Creative Commons license and your intended use is not permitted by statutory regulation or exceeds the permitted use, you will need to obtain permission directly from the copyright holder.



Innovation Practices

For exporting SMEs, innovation is their lifeblood and central to business longevity. The stories that the research team collected from successful innovators demonstrate how innovation can become an almost daily routine, and not necessarily involving a large research staff. Once they found their market focus and target segment, the management of some of the larger and more mature companies was able to put considerable development resources into their market space. To be successful requires an open mindset, an effective process to turn ideas into products, and an organization that is able to repeat this feat time and again as a matter of course.

- **19 Sourcing the Defining Business Idea**

How did the founders come upon their central, defining business idea that drove them on to shape the destiny of their companies? Although many of the firms profiled in this book are known for their products as they exist today, it is rarely known how they arrived at these ideas initially. Even a rejected job application turned out to be the source of a thriving company! By putting a spotlight on the ideation process, the authors hope to trigger future generations of company founders to be more effective in identifying such ideas. A central idea described is the *Open Mind* or *Open Eye principle* that emerges from the many conversations and interviews.

- **20 Innovation Processes**

For SMEs to survive in the long term, the companies need to innovate at regular intervals. This chapter sheds some light on concepts such as product platforms and how companies can be innovative, not only with products but also with material innovation.

- **21 Organizing for Innovation**

Successful SME founders and managers did not return to the office after a long weekend to declare *Today is Innovation Day*. Innovation in these companies took place on a constant basis; for that to be possible, a company needed to rig its organization to produce innovations akin to operating an assembly line. How companies managed to do that across a variety of business models is also highlighted here.



The Defining Idea

A *defining idea* can be characterized as a particular business, or product idea, that becomes central to the life of an entrepreneur and to the success of a company. It includes the product, or product line, that carries the company to success, regardless of whether this happened at the beginning, in the process of founding the company, or later on in the life of the firm. All companies covered by this research benefited at one time from such a *defining idea*, whether it came as a sudden *Big Bang* or in incremental steps, early or later in the company's life, externally sourced or internally derived.

Needless to say, this central or *defining idea* came to the firms' management in different forms. It seemed important to categorize the forms in order to demonstrate how these ideas were capitalized on. Some of the most intriguing aspects of the interviews, as retold in the company profiles, center around the stories *behind* the origin of a *defining idea*.

Leaving Unresponsive Employer

Quite a number of researched companies were created as a result of an entrepreneurial manager leaving his former employer, striking out on his own and developing a successful firm. This was a path taken throughout the period researched, involving both the oldest firm in the sample, **Sefar**, as well as a few of the younger ones. Founder Pierre Dufour was an employee-manager who split from a business owner and partner to set up an enterprise of his own; he went on to create Sefar, which is still active today. The idea for the business came through the association with his previous employer and partner.

The Bodmer family had been active in the silk industry for decades and were one of the wealthiest families of Zurich. In the 1820s, they hired the young and enterprising Pierre

A. Dufour (1797–1842) from Lyon, the capital of the European silk trade at that time, as a trading traveler. On behalf of Heinrich Bodmer, Pierre Dufour searched for possibilities of producing silk gauze in Switzerland. In 1830, Dufour succeeded in weaving the first silk bag cloth on a converted cotton loom of a weaver in the small village of Thal, in Eastern Switzerland, and subsequently started the production of silk bag cloth. However, in 1833, Dufour and Bodmer split up and Dufour founded his own company in Thal under the name Dufour & Co., later to become **Sefar**.¹

More than 100 years later, in the Eastern part of Switzerland, a similar trajectory can be observed: two optical engineers leaving their employer, going on to create their own company and benefiting from their technical experience in the optical field. They were helped by a friend who supplied the necessary capital for the company that was to become **FISBA**.

In 1957, **FISBA** co-founder Waldemar Striezel was working as an optical engineer at Wild Heerbrugg in the nearby Rhine Valley and he wanted to start his own company with his colleague Henno H. Altherr. Wild was a precision engineering and optics company, which would be later sold to Leica, the large German manufacturer of optical microscopes. His friend Christian Fischbacher (1916–2006), who was running his own textile business, helped them and together they launched Altherr Striezel. A year after the launch, Christian Fischbacher acquired all shares of the company which was renamed FISBA.²

The story repeats itself, this time in the Western part of Switzerland, where engineers, building on their experience in a particular line of business, in this case measuring devices, developed improved products and started their own companies, in part due to unresponsive employers who had not been willing, or able, to capitalize on the new developments.

Hans Meyer left Tesa in 1972 and started, with some former Tesa colleagues, Trimos, a new company to produce a line of competitive measurement devices. He had separately started an engineering office in 1973 under the name of **Sylvac** where his son Hans-Ulrich developed electronic height measuring gauges. This operation was finally incorporated to form Sylvac SA in 1978 with Meyer father and son, plus some former Tesa managers, as shareholders. The main business of Sylvac consisted of selling electronic control units for measuring devices to Trimos, a company founded in 1972 and partially owned by the Meyers.³

Jean-Pierre Etter struck out on his own, founding **LEM**. Etter began by selecting just two of the patented ideas from the engineering consulting firm where he had worked previously for ten years, unsuccessfully trying to secure any large-scale adoptions of their inventions. With a view towards commercializing these ideas, he chose one which dealt with measuring electric current.⁴

¹Adapted from Sefar company profile.

²Adapted from FISBA company profile.

³Adapted from Sylvac company profile.

⁴Adapted from LEM company profile.

The experience of Paul Wyser, founder of **Wyon**, a producer of rechargeable batteries, is a more recent example of a manager leaving a technology-oriented company, the Swatch Group, when his business idea was turned down because it did not fit into the established corporate strategy.

Wyon founder Paul Wyser had worked for Renata, a company now part of the Swatch Group. Originally, Renata produced mechanical watch components. With the growing importance of quartz watches, Renata built up the production of button cells for watches and became world leader in that market. When Renata was bought by the Swatch Group, Paul Wyser became a member of the extended management. In the 1990s, the company considered producing rechargeable batteries for the mobile phone sector in Switzerland. However, Paul Wyser was skeptical about this project because Asian firms had already been producing such batteries for five years. Instead, he proposed producing batteries for new applications in the medical sector, a market which Swatch did not want to enter. Paul Wyser had many business contacts in the battery related industries, including hearing aid specialist Phonak and he knew that there was a demand for rechargeable battery solutions in the medical industry. Thus, the basic idea for the company came from there and Wyon was formed in 1999.⁵

The above examples (**Sefar, FISBA, Mikrop, Sylvac, Wyon**) demonstrate that in many established companies, projects for new business, or products, are often not pursued. Engineers or managers in those firms, who might not have seen themselves as entrepreneurs in a classical sense, were nevertheless entrepreneurial enough to move on and create new businesses. In the course of daily business, one might wonder how many such situations occur on a regular basis and how many opportunities might not be grasped and are overlooked?

Another set of ideas stemmed from distributors or sales representatives who realized that their product suppliers were not sufficiently responsive to the impulses of the customer base and thus took the initiative to create their own businesses. From the present research database, two companies were identified in which thriving businesses were created on the basis of filling a supply gap left unattended by existing suppliers. **Filtrox** furnishes an earlier story, **Acutronic** a more recent one to illustrate this point.

Hans Schmid, founder of **Filtrox**, had worked in Switzerland as a sales representative for Seitz, a German company and the inventor of depth filtration. Up until the 1930s, the Swiss beverage industry completely relied on imported depth filters. Presumably due to political developments in Germany and the threat of the borders being closed, Hans Schmid thought about founding a company for the production of filter media in Switzerland. In 1938, he signed a licensing agreement with a competing filter specialist from Germany to acquire the necessary expertise and went from being a salesman to being a producer.⁶

Leo W. Marxer (1931), who had worked for the US company Goerz Optical Co in the 1960s, won the contract to distribute Goerz motion simulators and founded **Acutronic** in 1973. The inability or unwillingness of the predominating American Motion Rate Table suppliers to

⁵Adapted from Wyon company profile.

⁶Adapted from Filtrox company profile.

customize their products to local needs (i.e., local manufacturing, metric, customer support) created a great window of opportunity for the new company. In the 1980s, after a few years of being a distributor for Goerz, Acutronic got the chance to deliver position tables and become a maintenance repair organisation (MRO) for the European Tornado jet program. This was the kick-start for Acutronic as a manufacturer. Acutronic grew out of the Tornado business and in order to best serve Tornado clients all over Europe, subsidiaries were set up in Germany, France and the UK. Acutronic specialized in developing a wide range of motion simulators tailored to the needs of its European customers and established itself as the major supplier of such simulators in Europe.⁷

The origins of the *defining ideas* for these firms demonstrate that the daily work experience and industry environment can be a potent source of winning business concepts. It is a matter of capitalizing on such business experience, which might come at a later stage in a manager's, or engineer's career, provided they are able to switch from an employee to an entrepreneurial mindset.

Capitalizing on Personal Experience

Some company founders leveraged their defining business idea from a personal experience gained outside their normal business activities. Whether a result of luck, serendipity, or simply of an observant mind, and although being rare sources of ideas, these instances nevertheless deserve attention. They demonstrate that winning business ideas can be encountered anywhere, be it while taking a bath, walking across a parking lot, trying to master cables for a disco music business, or capitalizing on an educational degree program.

Ricola founder Emil Richterich (1901–1973) finished his apprenticeship as a baker and confectioner and opened his own bakery in 1930. It was said that Richterich, working hard, often felt tired and began taking herbal baths to relax himself. He began to experiment with herbs as a hobby before he actually turned it into a business. As a master baker, he knew how to deal with sugar, thus creating herbal sweets, which he sold regionally and directly to retailers. Over time, Richterich developed as many as 80 different herbal sweets. In the end, it was the original herbal drop that sold best and Richterich began to focus on it.⁸

Komax founder Max Koch, as a teenager, in his spare time ran a mobile company 'Discotheque Facilities'. The constant rewiring and reassembling of his equipment gave him the idea that an automated process could help with the crimping and reconnecting of the wiring. While a student at ETH he developed a car-mounted speed-measuring device. To make connecting easier, he developed and built an auxiliary device to cut the many copper cables to the correct length. This device, and the experience running the earlier disco business, lay at the heart of the Komax business.⁹

⁷Adopted from Acutronic company profile.

⁸Adapted from Ricola company profile.

⁹Adapted from Komax company profile.

When Hans **Oetiker** (1918–2002) stepped out of his small workshop in a hillside in the town of Horgen, he was often bothered by the oil and gasoline spots left behind by cars parked in the driveway in front of his business. His quest for a solution that would prevent cars from leaking oil or gasoline eventually resulted in a thriving global business. His solution, for which he was granted a Swiss patent, was an ear-shaped clamp, referred to as an ear-clamp, for which he also adapted his stamping machine to allow for mass production of the clamps. The ear clamp was a global innovation that was to fuel the business for more than 25 years when a succession of follow-on clamp designs was introduced to the market. Over time, the company brought to market several generations of different clamps, which were partial improvements of earlier systems, or new models, for better inclusion in automatic clamping systems.¹⁰

In 1997, Daniel Ammann, Andreas Thiel and Jean-Pierre Wyss, three PhD-students at the ETH Zurich under the supervision of Professor Gerhard Tröster, decided to leave their academic studies to start **u-blox** for the purpose of developing and marketing electronic modules for producers of communications systems with early emphasis on miniaturized GPS-receiver-modules. The three students had studied an earlier invention and patent from the US. Realizing that then current GPS systems based on several satellites could take one to five minutes to be activated and required seven to eight to establish a true position, the student team found several algorithms to accomplish this faster, use less field intensity than previous systems, do with less electric field strength.¹¹

Although only the *source* of the initial *defining idea* is addressed here, in all company examples, a number of necessary additional developments and engineering steps were taken in order for the founders to develop a marketable product and bring it to fruition. As these founders refined their ideas, they were driven by ample curiosity and perseverance. But what is outstanding here is their ability to envision a business idea out of experience or observation. They literally stumbled over, or into, the concept. In all three cases, there was an added element of previous experience, or a skill set, which, combined with the “Big Idea,” created an eventual solution.

Walk-Ins as Innovation Sources

One of the first companies to be visited and interviewed was **Plumettaz** near Bex (VD). Going over the sources for the company’s many innovations and changes in product line, covering almost 100 years, Denis Plumettaz surprised in the interview with an unusual story regarding the history of his company’s success: “We are practicing the *Open Eye Principle* of innovation.” Digging further, the experience with the man in the Rolls Royce surfaced. In the 1970s, Plumettaz had equipped many British Land Rovers with winches, some of them used by the British defense forces to tow trucks and tanks.

¹⁰Adapted from Oetiker Group company profile.

¹¹Adapted from u-blox company profile.

An engineer at the British Defense Ministry, who had become familiar with **Plumettaz** and its winches, had a friend whose business was to trade in patents. The two must have discussed Plumettaz because the British patent seller showed up one day at the Plumettaz factory in Bex: *One day, a man drove in with his Rolls Royce and asked if we were interested in a patent that could improve gear box functions through a speed reducer for winching* (Plumettaz, Executive Director).¹²

The **Plumettaz** engineers were intrigued enough to send one engineer to the UK plant that owned the patent. An exclusive licensing agreement was signed and the Plumettaz engineering team improved the idea to create its own Tranquart or Quadrant drive. This improvement of the gearbox, combined with its capstan drive technology, was leveraged to enter the staging market for the ever-growing number of skyscrapers that required difficult window cleaning. The Quadrant technology allowed for a much better control of the speed of the suspended gondolas from where crews had to work. In 1983, a licensing agreement was signed with a US supplier of stage-mounted traction hoists. Eventually, Plumettaz was to build and ship tens of thousands of these Quadrant gearboxes.¹³

The *Open Eye Principle* invoked by Denis Plumettaz was meant to indicate that there were many good ideas out there that could be the foundation of profitable and competitive businesses, or product ideas, provided that those hearing about them maintained an open mind and did not fall victim of the often quoted *Not invented here* (NIH) principle. Once the research team's interest was piqued, it took a closer look at the idea sourcing practices in Plumettaz's history and found that the concept of the *Open Eye* had been employed by the company over decades, sustaining its innovation drive. Plumettaz and its innovation sourcing principles will also be returned to in a section below dealing with disruption.

The practice of capitalizing on new ideas at **Plumettaz** led to the firms' entry into the cable laying business. Again, there was a first request and then a workable engineering solution supplied, in addition to further requests that forced the company to continuously support improvements.

An opportunity arose from a business deal with the British Post Office. Owner of a large fleet of Land Rovers, the Post Office acquired **Plumettaz** capstan winches and retrofitted its Land Rovers for use in telephone cable laying operations. The conversion involved removing the front middle seat and installing a capstan winch in its place.¹⁴

From the telephone cable operations in the UK, it was a small step to the Swiss market, which led to a substantial growth in the cable laying business.

Plumettaz's entry into the telecommunications cable market began in 1980 with an initial order from the Swiss Telecom, then PTT, for three capstan systems for laying fiber optics cables. This was to be the beginning of a long-term partnership and a complete shift towards a new market segment. The laying of optical fiber cables posed unique challenges. While copper cables needed a manhole every 500 meters for access to join cables, fiber optic cables

¹²Adapted from Plumettaz company profile.

¹³Ibid.

¹⁴Adapted from Plumettaz company profile.

used longer intervals. But the typical cable pulling mechanism proved ill-suited to the more fragile fiber cables.¹⁵

As Telecom companies throughout Europe were looking for solutions, experimenting with different technologies to lay fiber optic cables, Dutch Telecom had developed and patented an air blowing system that used a compressor to blow air through a tube holding the fiber. Again, it was **Plumettaz** that was faster in adopting this new technology and integrating it with its winching systems.

In 1990, the Dutch company first offered this technology to a German competitor of **Plumettaz** who declined the offer. When approached, Plumettaz, however, quickly realized the potential for significant efficiencies offered by this new method. Whereas winching could do about 15 m a minute, blowing could do 100 m in the same time. Plumettaz took out a 20-year license for Europe and Asia. An entire new line of products was developed and branded Cablejet.¹⁶

Blowing cables was not to be the end of the line for **Plumettaz** and its cable laying business. Once Plumettaz learned to drive cable installations by blowing rather than winching, it was natural to go to the next step and develop systems that used water as a driver for moving larger cables. In the process, Plumettaz built an entirely new competence around the jetting of cables, a long way from its original winching only for agricultural applications.

Having been exposed to the Plumettaz story of “The Man with the Rolls Royce,” the research team’s minds were open and alert to detect other similar situations that did, in fact, lead to central ideas around which entire businesses could and would be built. As it turned out, there were many of these stories, some of which were the basis of strong new businesses. For two companies, **Jura** and **EAO**, a single, external suggestion managed to give their businesses an entirely new direction, eventually leading to substantial growth and transformation.

Jura, as early as 1937, had introduced an electric coffee percolator, which remained part of its portfolio for a long time. In 1976, Italian entrepreneur, Sergio Zapella, visited Jura to present his espresso coffee machine for in-home use. His company, SAECO, was the first to develop espresso machines for in-home use. Up to that time, the market was of the opinion that good espresso could only be made by professional machines in restaurants or coffee bars. When discussing the possibility of adding this SAECO machine to the Jura product line, the company’s own marketing team considered the machine to be too expensive to produce. Testing at home by the company founders Henzirohs, and some company managers, led to the consensus to import the Italian machine for the Swiss market. In the process, Jura helped improve the SAECO machine in terms of quality and functionality and in return was granted the exclusive distribution rights for the Swiss market. The effort was successful and later Jura was to become focused entirely on espresso machines for in-home use.¹⁷

¹⁵Ibid.

¹⁶Ibid.

¹⁷Adapted from Jura company profile.

At **EAO**, the Olten company specializing on push buttons owned its entry into this business to a customer's suggestion. Until that time, EAO was focused on transformers for electrical cabinets.

One day, an electrical cabinet maker who sourced transformers from **EAO**, told the company about the problems he had with switches in his cabinets. Thalmann, one of the two founders, who knew something about switches and push buttons, then developed a push button made from plastic materials, with a small lamp inside to light up. There were no such products on the market in 1958. The lighted buttons found success and the reaction of the founders was: "Let's go and make some more." The suggestion of the electrical cabinet maker, and the response of the two company founders Loosli and Thalmann, eventually led to the products around HMI that became the dominant business of EAO.¹⁸

For some companies, there were multiple events, or external sources, leading to new business ideas. For **Kuhn Rikon**, two different inventors came to offer their ideas to the company, both of which were accepted and implemented.

Kuhn Rikon's Duromatic, the pressure cooker with a spring valve to release pressure, was launched in 1949. It became a defining product, still accounting for some 20 percent of company sales (2017). The product resulted from a chance meeting between Jacques Kuhn and an inventor from Zurich. Realizing the value of this idea, Kuhn Rikon took out a license and combined it with a bayonet-closing device designed by Jacques Kuhn. A joint patent was issued for the closing device and the valve making the use of the Duromatic both simple and safe.¹⁹

Kuhn Rikon's entry into the kitchen gadget business was owed again to a contact with an external inventor. As the story goes, in 1982, an inventor from Biel showed up one day at Kuhn Rikon with a design for a can opener that cut underneath the can's rim and avoided common injuries from opening a can. The company saw potential in the idea and set up a licensing agreement. The product found quick acceptance and a Swiss retail chain ordered 100,000 units. Through a friend who had sourcing contacts in China, the can opener was improved in 1998, such that after cutting one could put the lid back on. The connection to sourcing the can openers in large quantities from China eventually led to all kitchen gadgets and utensils being source from there.²⁰

Felco, the producer of pruning shears, also capitalized on the suggestions of customers from two sources in order to redefine its business. The company had its start in pruning loppers, made for pruning trees.

As the story goes, a wine grower approached **Felco** founder Flisch, asking for a hand-held pruner for his vines. Since he, Flisch, could make such good tools, maybe he could also make one for his use in the vineyard? The first design, named Model 1, made of forged aluminium and interchangeable parts, became an immediate success. Before long, other winegrowers asked for the same. Soon, a growing business developed for these pruning

¹⁸Adapted from EAO company profile.

¹⁹Adapted from Kuhn Rikon company profile.

²⁰ibid.

shears that have become the leading product for Felco. The follow-on model, Felco 2, has remained the company's bestseller since 1948.²¹

A second story, surrounding the introduction of cable cutters, began in a similar fashion. Someone came and said: "You know how to cut branches, why don't you build a tool to cut cables?" In response, Felco created a complete range of cable cutters in 1952, based upon a unique triangular cutting approach that allowed cables to be cut but not bent. The Felco cable cutters were used in many different applications, including automobile tire production, aerospace production and even some large ones used emergencies by sailing crews.²²

Thermoplan, the makers of automatic coffee machines for the hospitality sector, hit a triple by capitalizing three times in a row on the suggestions of customers, each time giving the business an expanded direction. Founder Domenic Steiner entered the business of building and installing professional kitchens for institutional clients and the hospitality sector. Attending regular equipment fairs, Steiner heard about the problems faced by hotel and restaurant kitchens.

The first major idea came to Steiner during his many exchanges with other fair visitors. **Thermoplan** founder Steiner learned that whipping cold cream was a 'pain point' for restaurant and hotel owners. Together with a local mechanical workshop they solved the aeration problem and in 1983 brought a cold cream whipping device on the market. It was half the size of existing equipment, considerably more user friendly, and allowed for the connection of a TetraPak cream container. This simple device, branded 'S'Whipper,' conquered the world.²³

The second major idea came in 1991, at another kitchen equipment show, when Steiner realized that the emerging trends towards cappuccino and caffe lattes would be a new opportunity for equipment to produce hot milk foam at the press of a button. Launched in 1993 under the brand name of 'Faomino,' Thermoplan's new equipment was designed on the same principles as its cold cream whipper.²⁴

The third defining idea came in 1995 when Steiner, making his usual rounds at restaurant fairs talking to users of Thermoplan's cream whipping and hot milk foaming machines, was confronted with the suggestion that only coffee was missing from the mix. The development of an automatic coffee machine for use in restaurants and hotels, however, was to require a considerable investment. The project was not without risk as several professional automated coffee machines were already on the market. Domenic Steiner, the company's founder, nevertheless, decided to take this next step. Recruiting a suitable engineering team, the company worked on the project for two years.²⁵

By following up three times in a row on market suggestions and successfully engineering solutions for those "pain points," Thermoplan grew the business to an annual production of more than 20,000 coffee machines shipped, employed some 300 people, and generated annual sales of CHF 300 million. In a later section, the

²¹ Adapted from Felco company profile.

²² Ibid.

²³ Adapted from Thermoplan company profile.

²⁴ Ibid.

²⁵ Ibid.

company's use of codevelopment and alliances that contributed to the growth of the business will be featured.

Power of Customer Suggestions

The defining business ideas discussed in this section did not originate in classical research departments. These were external, customer supplied ideas, free of charge, but accepting these ideas required concerted action and effort on the part of company management. However, the question can be raised: How does a company have to organize itself in order that such external ideas are properly evaluated and their potential understood?

The impression that all a company needs to do is to wait for a customer to walk in with an insightful idea does not reflect the entire reality. There is no question that these ideas were important, but they only served as a trigger for the development of a workable engineering solution. At the companies, it sometimes took a considerable internal engineering effort to turn these ideas into the basis of sustained success. How the initial ideas were continuously updated, refreshed, and improved will be discussed in a following chapter.

Just Reading About It

Defining ideas do not always have to come from customers. Sometimes, new ideas can be gleaned from published materials or scientific journals, as was the case at **Geistlich**, the producer of regenerative biomaterials.

In the early 1980's, Peter Geistlich, CEO and Chairman of the **Geistlich** company, and an avid reader of scientific journals, came across an article in a US-based journal about synthetic bone materials for regeneration, to be used in dental surgery. At the time, bone replacement or enhancements involved bone grafts from the patient and required a highly involved procedure. However, it was essential for patients who did not have enough bone mass left in their jaws. One of the leading experts in this field was Professor Boyne from California. Peter Geistlich was immediately attracted to the ideas behind the article and was determined that bone augmentation for dental surgery could be achieved using material from natural bones. He sought a collaboration and engaged in joint research with Boyne.²⁶

Rejected Job Application

Sometimes, even a rejected job application can lead to a business idea. This happened to Peter Grogg, founder of **Bachem**, upon his return to Basel after a long stay in the USA.

²⁶Adapted from Geistlich company profile.

Upon his return to Switzerland in 1971, Grogg, the eventual founder of **Bachem**, immediately applied for a job at Ciba, his previous employer. However, the company did not even bother to respond to his CV and job application letter. Grogg knew that research teams at Pharma companies produced their own peptides based on amino acid derivatives, a process he was familiar with from his US experience. Without a job offer, but undeterred, Grogg offered researchers he knew at Ciba to produce peptide synthesis needed for their research projects, thus taking away their 'pain' and freeing them from a time-consuming job and allowing them to instead focus on their research work.²⁷

Grogg, getting no response for his job application, developed Bachem out of this, a highly successful company marketing its products globally to leading pharmaceutical research organizations and developing an entire industry sector as a result.

What would have happened if Ciba (today part of Novartis) had accepted Grogg's job application?

Exploiting Disruptions

When a customer walks in with a new idea, this turns out to be relatively benign and does not challenge the survival of the firm itself. When a competitor, or a new competitive constellation, is the source of the new idea, it is often referred to as *innovative disruption*.²⁸ Several of the researched firms had experienced such disruptions. Their response, and how to capitalize on such events, is an important element in the longevity of some of these companies. Featured below are three companies that suffered from such an *innovative disruption*; each confronted the challenge in different ways.

Plumettaz, producer of winches, has served as an example for the *Open Eye Principle* in terms of responding to customer ideas. The company had already demonstrated how to integrate new technology solutions into its winching business, which was entirely focused on the vineyard sector.

When regular plowing of the vineyards was abandoned, the need to winch plows on tractors up and down steep vineyards became obsolete. This change of agricultural method impacted heavily on **Plumettaz**, at that time largely a supplier for vineyards. The company's experience with the tractor-mounted self-propelled winches based upon its capstan technology was used to explore other applications of similar type. The nearest, and most obvious, was found in the forest industry. Collaborating with the regional forestry services, the Plumettaz design office created two types of capstan winches to be integrated with Land Rovers, the four-wheel drive vehicle popular in forestry services and used for hauling timber onto the road. The installation of capstan winches onto Land Rovers brought Plumettaz to the attention of British Leyland, the manufacturer of Land Rovers. An initial order to equip scores of Leyland trucks were followed up by further orders, swelling the order books of Plumettaz.²⁹

²⁷Adapted from Bachem company profile.

²⁸Christensen CM (1997) *The innovator's dilemma: when new technologies cause great firms to fail*. Harvard Business School Press, Brighton, MA.

²⁹Adapted from Plumettaz company profile.

As documented earlier in this chapter, **Plumettaz's** British connection was to prove important because it took the company out of purely agricultural applications and into new fields that changed the course of the company. By 1973, the anniversary of Plumettaz's 50th year, company sales for nonwine-growing use of its winches exceeded, for the first time, wine-growing applications. This was a trend that continued, and by 2018, wine-growing sales represented only a very small percentage of company activities. This was achieved because Plumettaz continuously grabbed opportunities—be they welcome or imposed—from external sources, incorporating them into its business. Without having done so over its decades-long history, the company would have suffered from mortal disruption years ago.

Disruption can also be caused when parts of a company's business are sold, which is the story behind **maxon's** development and later success. Created in 1963, under the name of Interelectric,³⁰ the company's first mandate was to produce shearing foils for Braun, the parent company's electric razor. When Braun decided to divest its electric razor business to Gillette in 1967, the business located in central Switzerland lost its main internal customer.

At **maxon**, an internal development team had begun work on further developing small electric motors intended for eventual use in Braun razors, stemming from a project undertaken at Braun even prior to starting-up the Swiss foil production. With the loss of its razor shearing foils business, the company owners asked the team to intensify the development of small electric motors which could be the basis of a new business orientation and capitalize on the earlier development of a hand-operated small appliance. In the short period of about two years, the design team developed a range of small electric DC motors, including a patented process for an ironless rotor which doubled the efficiency of motors available based upon standard technologies, as well as extended the product service life. The product range 'maxon' stemmed from a combination of the name 'Max Braun & Söhne.' The new line was launched in 1969, just two years after the sale of the shearing foil business to Gillette.³¹

One is reminded of the saying *necessity is the mother of invention*. The threat of innovation disruption is particularly acute for a company with an ongoing business facing substitution, or sidelining, through a larger company that could eliminate its competitive advantage. That this might happen once is one thing. But when it happens twice in a row, an SME is truly challenged to respond. Such was the case at **Fraisa**, the metal tool manufacturer which suddenly saw its business existence at stake. The challenge did not come from a competing toolmaker, but a company producing coatings for tools to extend their life. How Fraisa owners and managers responded is a stellar example of gutsy business survival decisions.

Fraisa's owner Hans Stüdeli was quick to react when, in 1980, Balzers, a Liechtenstein-based company, demonstrated a new technology for surface hardening of metal tools, extending their useful life. Already the first generation of this thin film coating technology,

³⁰The name maxon Motor was adopted only years later as company name. Its motors had earlier been branded maxon. Most recently, the company name was changed solely to maxon.

³¹Adapted from maxon company profile.

called PVD coating, extended tool life by a factor of 0.5, and coated tools could operate 1.5 times faster than standard steel tools. The 2nd generation extended tool life by a factor of ten and allowed to operate 2.5 times faster in comparison to uncoated tools.

Fraisa's owner was quick to see both the potential and threat of this new technology, and that this could radically change the tool industry. Fraisa became the first end mill manufacturer to adopt this new coating technology, which, since applied at the end of the tool production process, required Fraisa to understand vacuum coating technology. Fraisa thus became the first tool making company to adopt coating, while other firms in the same industry were hesitant to take the step. In addition, Stüdeli priced the coated tools at a premium of only 1.5 times the price of regular tools for the first generation, and 2.5 times for the second generation, something that other tool makers could not understand. They pushed Stüdeli in vain to increase his prices.

A customer who buys this tool will not soon buy another tool. If we do not adopt this new technology, another company surely will. Customers will save on machines by buying fewer machines. They will not save on tools because their speed was up. Self-cannibalization is better than being cannibalized (Maushart, CEO, quoting company founder Stüdeli).³²

A few years later, Fraisa was once more confronted with a threatening development, this time on the material side. Over time, materials harder than steel became increasingly used in the industry, changing the requirements for the tools used to work on them. Newer, harder metals required new cutting materials for the cutting tools. Fraisa had, at first, hesitated to respond, leading to a loss of competitiveness and loss of sales. A young development team was tasked in 1990 to find a response for the company.

Josef Maushart, a 25-year old engineer, who was later was to become CEO and owner of **Fraisa**, joined the group in 1990 tasked with developing hard metal tools. "We were behind, almost too late" he recalled. The team decided to respond by coming up with a next generation tool, leapfrogging developments and avoiding mistakes made by the pioneers. With a new industrial norm for hard metal to meet (DIN), the young team was able to present their first solution in Hanover in 1993, and tools for high-speed cutting for aluminum and steel at the Milano Fair in 1995. Despite the late start, the entry into the age of hard metals had been accomplished after all.³³

The examples of Plumettaz, maxon, and Fraisa tell us that even when a market appears lost, or an entire industry shifts, this can be the beginning of something new.

Borrowing from Other Industries

So far, the sourcing of ideas has relied on customers bringing in new ideas, unresponsive employers being left or disruptive developments necessitating new answers. There is, of course, another source of ideas: observing other industries and

³²Adapted from Fraisa company profile.

³³ibid.

transferring industry practices, not out of necessity but in order to capture an opportunity. Although this did not happen frequently among the researched companies, there was one example that does come to mind, **Felchlin**, the supplier of chocolate specialties for praline couverture. In its search for differentiation, the company adopted the Grand Cru story from the coffee industry, and the single malt approach for whiskey, and applied it to cacao bean selection and processing.

Traditionally, industry treated all cocoa beans essentially as a commodity. **Felchlin** decided to take a page out of different industries and to develop a chocolate product line made from distinct, labeled and identified beans, such as was the case in the coffee industry. The Felchlin team was intent on going back to the roots of cocoa and identify special growers in South America who were small-lot farmers organized into cooperatives. The resulting Grand Cru Selection consisted of single origin couverture, similar to single malt spirits. The process of moving into the Grand Cru product line was accelerated in 1999 with the launch of the single origin couvertures, eventually leading to some 25 different crus, differentiated into many different levels of cacao, flavor intensity, milk intensity, plus vegan or lactose free combinations.³⁴

To market these specialties, a new language had to be created. For that purpose, Felchlin leveraged the experience of the agricultural and winegrowing department of the University of Applied Sciences in Wädenswil. Together with the school, Felchlin developed a language to describe the taste differences of chocolate and cocoa beans.³⁵

The adoption of the Grand Cru strategy was not forced upon Felchlin, and its adoption was not triggered by any particular industry turmoil. What this process demonstrates is the richness of new ideas to be harvested by open-minded company founders willing to look beyond their own industry barriers.

Practicing the Open Mind Principle

Reviewing the many different sources of new ideas demonstrates the eclectic beginnings of many of the SMEs documented in this book. The *defining ideas* were gleamed through observations and did not come as a result of formal research or tabulating surveys. The ideas were not the result of planned research. Rather, the company founders connected the dots between a number of developments in the market where many others, confronted with the same realities, did not see any new business opportunities. The further development of these ideas still took time to accomplish, and once a business started to grow around that initial idea, more formal development efforts were added to support it. Keeping an open mind, open eyes, and even open ears was, and remains to this day, the principal means for the SME founders to launch their companies.

³⁴Adapted from Felchlin company profile.

³⁵Ibid.

Open Access This chapter is licensed under the terms of the Creative Commons Attribution 4.0 International License (<http://creativecommons.org/licenses/by/4.0/>), which permits use, sharing, adaptation, distribution and reproduction in any medium or format, as long as you give appropriate credit to the original author(s) and the source, provide a link to the Creative Commons license and indicate if changes were made.

The images or other third party material in this chapter are included in the chapter's Creative Commons license, unless indicated otherwise in a credit line to the material. If material is not included in the chapter's Creative Commons license and your intended use is not permitted by statutory regulation or exceeds the permitted use, you will need to obtain permission directly from the copyright holder.





Product Innovation Over the Long Haul

The extensive examination of the defining innovations, which were gleaned from the documented companies, was driven by the importance those early decisions had in shaping the companies. Most of these ideas were product innovations. The separation of the *defining ideas* from ongoing product innovations was based upon the need to show that following an initial *Big Bang* step, company management then had to refine these product ideas over time. While the first ideas were often generated from the outside and involved little or no formal research or development, the firms needed to engage in the constant renewal of their product lines in order to stay on top. It was observed that this is actually a different process: one that is most pronounced at those companies where the starting idea was built upon over a long period of time.

Among the oldest firms observed, product innovation was a process that never stopped and that allowed the firms to remain competitive on a global basis. Although this was often combined, or even led, by process innovation, to be addressed later, constantly renewed, improved, and reengineered products were a crucial part of the mix.

Examples of this long-term product improvement process were offered by **Sécheron**, the electric train component supplier, and **Burckhardt Compression**, producers of industrial compression systems. Both companies were more than 100 years old, and they continue to renew their products on a regular basis with internal engineering resources, some of them for customizing equipment for new sales.

Sécheron had captured the position as the world's leading supplier of electrical equipment for DC traction substations with an installed base across many countries. Sécheron leveraged extensive knowledge of the technologies used in railway components through extensive in-house engineering capabilities. Sécheron offered both standard and customized solutions and extended its market coverage to provide solutions for energy storage and recovery.

Sufficient resources were present to fund such internal development, and a group of about 100 engineers in Geneva, and elsewhere, were developing and improving its product line.¹

Over decades, **Burckhardt Compression** remained focused on oscillating compressor technology and relevant application segments, avoiding the larger rotating compressor segment. Even though this was a mature technology, the company still managed to develop and refresh its product line by steadily adding new and improved models for new or emerging application segments.

The forerunner of **Burckhardt Compression** recorded its first compressor sales in 1883 with a patent granted for its two-stage compressor. Burckhardt was able to develop a series of different compressor models that were both innovative and high in demand by industrial users. Over a period of about 50 years, the company launched compressors used in ammonia synthesis applications requiring very high-pressure levels. Burckhardt had always benefited from excellent in-house engineering talent that made the development of superior compression systems possible. To this product line, a family of labyrinth compressors was added when Burckhardt was acquired by Sulzer in 1969. The world's largest and highest performing compressor was installed by Burckhardt in 2007. This was followed by a new design for the Laby-GI for dual-fuel-stroke engines for large LNG tankers used for direct injection of boil-off gas into the diesel engines of the tankers.²

Reinventing at Regular Intervals

For most companies, a steady stream of new products introduced over time, at fairly regular intervals, was an assurance that the market position would be maintained. Also, indispensable was having a clear idea of the market space that the company wanted to occupy, one that would serve as a guide for the product innovation process. **Thermoplan**, maker of automated coffee machines for institutional users, serves as an example of this constant and steady process of renewal.

Thermoplan described its market space focus as the range of hot-cold-drinks-beverage, which signaled potentially moving beyond coffee. Although no plans were officially publicized, the company was known to work on tea and chocolate as possible future options. All engineering and development was performed at Thermoplan's location in Weggis, Switzerland. The number of staff employed in its development functions were estimated at about 20 percent of total employment, or more than 60 specialists from various of engineering and science disciplines. A design Center was maintained in the Canton of Valais where Thermoplan staff regularly met with customers.³

Thermoplan coffee machines were constantly improved since the launch of its B&W Generation One model. In 2007, Thermoplan was the first company to integrate a cold milk foamer into its fully automatic coffee machines. In 2011, the company followed up with a catering coffee capsule machine. The Telemetry System was introduced in 2014 allowing

¹Adapted from Sécheron company profile.

²Adapted from Burckhardt Compression company profile.

³Adapted from Thermoplan company profile.

customers to electronically monitor their machines' performance on their PC via ThermoplanConnect. LatteArtist was introduced in 2018 with its B&W4 generation machines allowing for the creation of artistic designs in the milk foaming phase of preparing a cappuccino or latte.⁴

Pilatus, producer of general aviation planes, had maintained its product innovation rhythm over decades, going back to the company's creation in 1939 and maturing into a new set of competences as the company accumulated new skills with each new product launch.

For **Pilatus**, growth from a maintenance role into assembling, or subcontracting of parts, into a full-fledged developer and builder of competitive training or civil aviation planes, including jets, was a step-by-step process. With each, the company gained valuable experience added to its already existing know-how. The ruggedness of its earlier training models was carried over into its civil aviation models. The experience gained in maintenance was capitalized by constructing planes for easy maintenance. The need to provide multiple variations of the same model series led to modularization. The experience with STOL in its PC-6, its first civil aircraft, was rolled over into its PC-12 and PC-24 executive airplanes allowing for the utilization of thousands of small and sub-optimally equipped civil airports in rural regions. Over time, Pilatus accumulated the experience needed to become a full-fledged airplane design and building company.⁵

At **Jura**, the maker of espresso machines for home use, the acceleration of its innovation rhythm and new product launch became a key strategy element.

Because competitors could quickly imitate espresso machines features, **Jura**'s strategy was to constantly improve on its machines. The intent was to stay one model generation ahead of the competition, becoming a moving target of perennial innovations. This led to an innovation rhythm of new machine models every year, and with new model sales consistently representing a major part of annual sales. Many of Jura's staff at its head office in Niederbuchsiten was devoted to this effort.⁶

Product Platform Innovations

For companies operating from established product platforms, the product innovation process often involved product generations or took the form of versioning—rapidly expanding the applications from a major product platform. The platform provided some guardrails for the direction of the innovation process, and the goal became to expand the number of items, or SKUs, to accommodate as many different application variations as possible. Companies pursuing this strategy tended to have larger development staffs and spend higher amounts on development as a percentage of sales.

⁴Ibid.

⁵Adapted from Pilatus company profile.

⁶Adapted from Jura company profile.

Among the researched firms, **u-blox**, **EAO**, and **LEM** serve as examples of how a potent product platform calls for constant renewal and development of ever more variations for ever more applications.

To drive its innovation, **u-blox** invested about 20 percent of sales in development. The company engaged not so much in research but concentrated on development. Applying technology to a particular function, the company wanted to be ready for the next technology phase. This meant to enter into extensive collaboration with universities and to be in constant contact with the market to correctly spot the latest trends. Only then did u-blox decide on the commercialization of new ideas.

If there was an innovation philosophy at **u-blox**, it could be described as applying new technology for its customers' use, not so much as inventing technology. This still challenged the company to be ready to move on to the next phase of an emerging communication technology as the fastest follower to apply the new technology. Thus, spotting trends was essential for the company to decide on what and when to commercialize. This philosophy of technology development was also evident in the product technologies adopted. At the outset, u-blox tended to acquire chips on the open market and adopted them, through modules, for its use. With more experience gained, the company did eventually shift to its own chips once the applications began to mature. The first u-blox chip set was brought to market in 2007. Others followed, in succession.⁷

For **LEM**, development was crucial to further develop the efficiency and quality of its components.

LEM invested about CHF 28 million annually into R&D (2019), or about 9 percent of sales. Product families were constantly improved, updated and functionally extended to keep pace with the changing requirements of its customer base. Product development was decentralized and had to be close to customers. Engineers for Huawei, China, had to be located in China and it did not make sense to make a loop through Geneva for each issue.⁸

At **EAO**, the process for new product configurations took place at each production site.

It involved different types of talents, such as mechanical and electrical engineers, specialists in material science and some software developers, as well as product managers and production specialists. The team proposing a new product was tasked to put five core value propositions on a single page, not to create a large book of technical specifications. The key questions to be answered were: 'Who is pushing the button?' and 'Why is this person pushing the button?' The user's task to fulfil and its experience was always a core value for new products ever since the two founding pioneers started EAO.⁹

Oetiker, producer of clamping products, maintained a steady flow of innovations once the initial clamp design had been launched. The innovations included assembly and installation tools to make the clamping installation process more efficient.

⁷Adapted from u-blox company profile.

⁸Adapted from LEM company profile.

⁹Adapted from EAO company profile.

Ever since the development of the first punching machine in 1947, company founder Hans **Oetiker** followed up with a range of new connecting systems at regular intervals. Oetiker supplied a full product line of clamps where the successive new models of clamps were driven by customer requirements, always keeping old models in the line-up, too. As a result, the product line became cumulative, all later clamp models being improved variations of earlier ones. Over the past ten years, the company brought to market several generations of different clamps which were partial improvements of earlier systems, or new models, for better inclusion in automatic clamping systems. Most of the Oetiker clamping products remained in production for many years and some were produced for its replacement parts business. Other than clamping and connection systems, Oetiker also brought new installation systems to the market. While the rhythm of new connection systems was managed from the center, the various locations, through their multiple direct contacts with customers, contributed ideas for new products or assembly systems.¹⁰

The innovation rhythm maintained at *platform* companies required close connections to their customer base, which was frequently maintained from international production or sales distribution points.

Innovating with Materials

While product-based innovations are much more visible and reflected in the offer of a company, innovations around materials take place more often behind the scenes. They are, nevertheless, very important to production-based industries, such as those reflected in this research. At times, material innovation can be central to the development of a firm, while missing a material change can mean a loss of competitiveness. Conversely, the ability of leading material changes can bring added competitiveness.

For most of the researched companies, the primary production materials did not change significantly. For a few, the production material did change over time, but at such speed that it was hardly noticed by outsiders.

- In the case of **Pilatus**, the aircraft manufacturer, the material originally used for airframes was wood; it then gradually changed to metals, mostly aluminum, but did so over the course of many years.
- At **Fraisa**, the machining tool producer, the change came largely in the materials its customers used, therefore forcing a change in the tool design.
- For **Kuhn Rikon**, the change was represented in the addition of its kitchen gadget line, which was made mostly of plastic materials, a change that was absorbed by using outsourcing for those products, allowing the company to continue with its aluminum-based cookware business in parallel.

¹⁰Adapted from Oetiker company profile.

For both **Geistlich** and **Sefar**, the change in materials substantially affected their business. In the case of Sefar, shifting from natural to synthetic fibers allowed the company to maintain its edge and gain new application segments.

When nylon was invented shortly before the Second World War, **Sefar** started working with synthetic fibers which required that new weaving techniques had to be developed. In 1945 nylon yarn was woven into gauze on a mechanical loom for the first time and in 1950, after lengthy experiments, the company succeeded in producing nylon fabrics that were more effective and durable than silk products. In the 1960s, synthetic fibers increasingly replaced silk until the production of silk bag cloth was discontinued altogether in 1990. Since it is possible to apply various chemical coatings onto synthetic fibers, Sefar added refinement as a new production step. The field of possible applications for Sefar fabrics also became more extensive. Synthetic fibers allowed for filtration applications in the automotive industry that were superior to metal filters. After great efforts, Sefar managed to make this area one of the most important business segments today.¹¹

Geistlich, producer of natural bone-strengthening materials, went into a totally new direction with products launched in 1986 and successively extended their use into broader indications for bone loss. The development process was centrally driven by the nature of the biotech industry and its controlled production environment. Building on the initial innovation, the company expanded its product and materials platform at regular intervals.

By 1986, **Geistlich** had launched two products: Geistlich Bio-Oss[®] and Geistlich Bio-Gide[®] to enhance jawbone structures for dental patients, enabling the insertion of implants where previously prevented by insufficient bone support. After the successful entry into the dental regeneration market, Geistlich launched Orthoss[®], a bone regeneration material in connection with orthopedic bone defects. This was followed in the 1990s by Bio-Gide[®], an absorbable collagen membrane for dental surgery and Chondro-Gide[®], a collagen material for cartilage defects. Bio-Gide[®] was a natural bilayer collagen membrane superseding non-resorbable membranes, simplifying surgical techniques and effectively revolutionizing bone regeneration. By 2004, only about 15 years after introduction, Geistlich's Bio-Oss[®] had become the most often used bone replacement material in oral and maxillofacial surgery.¹²

For the companies described above, the changes in materials relevant to their products and production processes were critical. If the companies had not managed to engage in changing materials, market positions would have been lost.

Innovating Production Processes

In the context of innovation, it is important to notice that significant innovation can occur around industrial processes. Previously, the focus in Chapter 15 was on the choices around production processes. For many companies, developing proprietary

¹¹Adapted from Sefar company profile.

¹²Adapted from Geistlich company profile.

production processes has been extremely important. Ultimately, such processes are powerful, particularly in terms of defending against international competition.

For **Geistlich**, the change to biomaterials opened up an entirely new business opportunity that affected its entire business, from research to production and market segments.

For **Geistlich**, the process of shifting production from the traditional industrial processing of animal bones and tissues towards biomaterials began in the mid-1980s and was completed by 2001. This required a fundamental shift in operations that became noticeable to people living in the vicinity of the Schlieren and Wolhusen plants when the persistent strong odor emitted from the plants suddenly stopped. Gone were the trucks and railcars delivering bones by the tons or truckloads. Instead, the company now delivered its products in small dosages, typically one gram for a single procedure. One kilogram of the new materials was reported to cost CHF 200,000. Instead of tons of industrial materials, the company shipped biomaterials annually measured in a few hundred kilograms.¹³

The researched companies where proprietary industrial processes were preceded by significant innovations are featured in this short section. The firms which utilized proprietary manufacturing processes did, in fact, at one time engage in process innovation. Some of those innovations are included here again as a reminder; more details can be found in Chapter 15 in Part VI.

- **Medartis**, producers of orthopedic trauma implants, developed an innovative process to machine titanium screws.
- **Rüeger**, manufacturer of temperature gauges, developed a manufacturing process that remains unique to this day.
- **maxon** developed its own winding process to produce small electric motors, improving from the initial ten minutes per rotor down to as fast as 12 seconds per rotor, all with equipment and processes developed in-house and not available on the open market.

Winning at the Innovation Game

Most of the SMEs covered in the research sample did not innovate in one single, major step to arrive at a new product. Instead, these companies practiced step-by-step innovation, making improvements over time whenever a step could, or should, be improved, seeking excellence over a long period of time.

The innovations have been pursued on a number of different dimensions, such as with a product, a new manufacturing process, or new materials. Companies did not always follow the same dimension consistently, but instead might meander between one innovation path or the other. When combining different paths of innovation with a steadfast focus on the same target customer, or industry, even small companies can

¹³ibid.

build considerable competitive advantage over time. It was particularly those innovation steps that were not visible in the final product that have been the longest lasting and the most difficult for competitors to duplicate.

Open Access This chapter is licensed under the terms of the Creative Commons Attribution 4.0 International License (<http://creativecommons.org/licenses/by/4.0/>), which permits use, sharing, adaptation, distribution and reproduction in any medium or format, as long as you give appropriate credit to the original author(s) and the source, provide a link to the Creative Commons license and indicate if changes were made.

The images or other third party material in this chapter are included in the chapter's Creative Commons license, unless indicated otherwise in a credit line to the material. If material is not included in the chapter's Creative Commons license and your intended use is not permitted by statutory regulation or exceeds the permitted use, you will need to obtain permission directly from the copyright holder.





Organizing for Perpetual Innovation

Given that innovative ideas are expected to be generated on a permanent basis, it is interesting to observe that among the documented firms, there were special practices in place to assure that ideas and improvements would *roll off the assembly line* of innovation. Such organizational practices were particularly prevalent in firms which could be classified as *platformers*, or those practicing and dependent on a steady stream of new product versions, or variants.

Creating an Innovation Assembly Line

u-blox had perfected a complex, globally distributed, but centrally directed, development organization that managed several hundred projects simultaneously. Of particular importance were the organizational practices the company adopted to connect the entire development effort as if it were taking place at a single location, while leaving the development *nodes* in place at their respective, different locations to avoid disruptions through relocation of staff.

u-blox operated 15 research and development centers across the world. Its acquisition strategy was closely linked to the need to ramp up development capacity. Starting early in its development, the company concentrated on acquiring engineering teams abroad, avoiding the acquisition of operating businesses and leaving these teams in their original locations. Relocating all of these specialists to the Swiss operations would have resulted in losing many of them. Leaving them in place meant that they could continue working where they wanted to live with their families. Some of these teams were very small, just a handful, and the largest one in Italy had a staff of about 100. The development process was coordinated by the company CEO, assisted by two co-CTOs. At any time, there were

about 300 projects in the pipeline, 100 to 200 of them were major ones and the rest variants of others.¹

Teams at **u-blox** would connect regularly online, discussing technology and design only, following a particular routine: Teams would always meet on the same day of the week for a given project or device. These online meetings would last for anywhere from 30 minutes to two hours. Timing was rotated such that, as an example, the Thalwil Head Office team would be on in the morning in week one, around noon in week two, in late afternoon in week three, and in the very early morning in week four. Then the rotation sequence would be repeated. Other teams in other locations and time zones would adjust accordingly. As a result, a given team would only have one inconvenient meeting time over the four-week cycle. This meeting schedule was designed so that development engineers did not have to travel extensively. Instead, it was the co-CTOs who traveled between the teams.²

maxon, another *platforming* company, organized itself to enter many segments based upon its product and technology platform, spending as much as 8 percent on sales on its development effort.

maxon found entry into many application areas. While originally starting out building motors for consumer applications, the segment composition was subject to constant changes and evolution, requiring adaptations and innovation on the part of the company. **maxon** employed about 200 specialists, mostly in Switzerland and some in Germany, and spent about 8 percent of sales on the effort. Once the company began to grow, the majority segment had been industrial robotics carrying as much as 50 percent of sales. This declined to about 20 percent in 2018. The segment then moved into robotics and automation, including transportation. Taking its place, in turn, as segment leader was medical, with as much as 50 percent of sales. The aerospace segment was also shifting from pneumatic driven to electronic driven, expanding sales opportunities. The transportation segment moved from functional mobility to system partners, as in the case of the e-bike system where **maxon** became industrial partner for its **maxon-Bikedrive**, consisting of rear motor, battery and controller.³

For some companies, investigating, researching, and documenting their customers' activity cycle (CAC), or internal value chain, yielded the insights which stood at the beginning of innovations of important benefits to their clients.⁴ This practice was the basis of much of innovation at **Komax**.

The **Komax** strategy on wiring systems came with a new view towards its industry that created many growth opportunities. The company analyzed the entire wire harnessing production cycle and the time each step would take. While important from an efficiency point of view, cutting, stripping and crimping, the core activities of **Komax** systems, accounted for only 20 percent of the time needed to create a wire harness in the automotive industry. Routing and taping accounted for 28 and 25 percent, respectively. New insights

¹Adapted from u-blox company profile.

²Ibid.

³Ibid.

⁴See Vandermerwe, S (1993) Jumping into the customer activity cycle. *The Columbia Journal of World Business* 28(2): 46–65.

came from investigating the entire value chain of its customers, going beyond what had been the focus of the initial wiring systems. The strategy was now that Komax clearly wanted to expand its 'share of the wallet' of its main customers and enter value chain steps previously left to other companies.⁵

Komax founder Koch described the development of his equipment as stemming from his frequent visits to the assembly plants of his customers. During such visits and the close cooperation, customers were communicating their production pain points and Koch could follow up with engineering solutions. Koch emphasized simplicity in his solutions, with equipment that made production simpler, was easier to use, while at the same time meeting customers' highest engineering demands.⁶

To support this effort, Komax spent 8 to 10 percent of sales on innovation, research, and development, an amount that was maintained even during the 2008 financial crisis.

At the end of 2017, **Komax** employed about 200 professionals in the area of research of development. The majority, about 140, were located in Switzerland. Beyond the Swiss sites, Komax maintained development units in China, Germany, France, Japan and Singapore. Not included in the above numbers were about 170 development engineers who worked on customer-specific projects. The headcount in research and development had been boosted by recent acquisitions of companies with a high proportion of development specialists on their staff. These acquisitions, together with the general business expansion, increased the R&D relevant headcount by 20 percent over previous years.⁷

To ensure effective and productive development, Komax deployed interdisciplinary development teams critical to its innovation strategy. Teams dealing with different processes and technologies, including experts from marketing and product management, in addition to development engineers, simplified interfaces and reduced lead times for new products.

Bachem, producer of peptides, employed a similar approach to surround its customers, the research community, and innovate around the Customer Activity Cycle.

Bachem articulated its approach as the 360-degree business model by surrounding the entire life sciences product and research process with products and services at all steps, from initial research, including pre-clinical development, clinical development and the supply of peptide drugs up to commercial scale introduction.⁸

When major innovations were pursued, some companies found it advantageous to keep the pursuit of new ideas apart from managing daily business and created separate teams, as **DC Swiss** did, or even to create separate entities, a practice **Felco** adopted.

⁵Adapted from Komax company profile.

⁶Ibid.

⁷Ibid.

⁸Adapted from Bachem company profile.

As a small company in the tool industry, **DC Swiss** found it necessary to create a separate organizational space for its development units, both internal and external, to ensure development productivity and leverage a small development resource base.

DC Swiss maintained a small research and development team of five that enjoyed relatively high research output. Over five years, four new patents were granted to DC Swiss, and another two patents were pending. In 2011, the company founded Safelock SA with its own small staff of about five, organized outside DC Swiss. This spun out unit was aiming to commercialize a special design and technology, patented by DC Swiss, that came with an automatic blocking system for interior threads to be used with specially designed screws for Nano applications. Custom designed screws were also supplied by Safelock. Among the benefits of this screw system were connections that did not require chemical additives, such as glue. This was important since many customers still added glue to the fastening of screws.⁹

In 2008, when **Felco**, the maker of manual agricultural shears, decided to enter the space for cordless portable power tools, the company felt that an entirely separate organization was needed and set up FELCO Motion as a separately incorporated firm.

As cordless battery-operated tools started to be a must for the professional users, **Felco** decided to launch a strategic project, to develop its own line of portable power tools in house. After an intensive study of the market potential and the investment needed, a green light was given by the owners. Two years later, a separate company, FELCO Motion was born. Its main mission being to develop, industrialize and assemble the entire new range of Felco brand battery-operated pruning shears. To underline this, the board appointed the former CCO of Felco as CEO of the new company, who was to report directly to the board and not to Felco management. Besides, FELCO Motion was housed in a distinct part of the Felco manufacturing complex. To answer this challenge, the new company hired about ten micro technicians and electronics specialists. FELCO Motion maintained its own small production, assembling and distribution through the Felco network. There was frequent contact with Felco management, of course, aided through co-location of the operations.¹⁰

Entering into Customer Partnerships

Given the small size of most of the documented firms, entering into customer partnerships for the development of new products, or processes, was essential to leverage limited resources. Effective partnerships reduced technology and market risks and, in many ways, extended the available resources to be invested by SMEs.

These collaborations can, and did, take many forms. At **LEM**, it was part of the company beginnings. Collaborations were woven into the daily business life at **Bachem**; for **FISBA**, they took the form of an OEM-type relationship; at **Felco**, the partnership involved a new product line; for **Thermoplan**, the partnership was

⁹Adapted from DSC Swiss company profile.

¹⁰Adapted from Felco company profile.

entered with a lead customer, as was the case with **maxon**. In the following section, some background will be provided on each of these types of partnerships.

Without the co-invention approach, developed by **LEM** founder Etter early on, the company might not have gotten off the ground so fast and so easily.

Learning from failures to convince companies to accept their technical inventions, **LEM** founder Etter was looking for well-known companies that might be interested in co-inventing and would co-develop a complete working system and use it themselves. They would become the launch customer, indirectly prompting others to adopt the new system as well. The local Sécheron company, with whom LEM was collaborating, introduced LEM to the French TGV train builders triggering in return an introduction to GE in the US and to the Chinese railways, which resulted in many other opportunities for applications. Railway and transportation applications became an important user segment for LEM, although over the years it was eclipsed by other segments.¹¹

The customer partnership practices at **Bachem** covered custom-made products only, as the catalog business contained standard products.

A key element of **Bachem**'s partnership with key customers were long-term supply agreements that could stretch over as many as 15 years. Multiple co-operations were also entered for the development of pharmaceutical products, such as with GlyTech of Japan in 2013, that led to the successful co-development of interferon B-1a up to industrial scale production, once interferon B-1a was approved for the treatment of multiple sclerosis. To the pre-clinical development teams of biotech and pharmaceutical companies, Bachem was able to offer custom-made peptides for the extensive panels needed in the process of further refining target compounds, involving close partnering with life sciences companies. During clinical development, when the target compound had been identified, Bachem engaged in close collaboration around the optimization process needed for the development of formulations, scale-up of production and eventual validation. In the launch phase of a new drug project, Bachem was able to act as the contract manufacturing organization, providing manufacturing up to full-scale volumes on a flexible basis, particularly important to customers in the early launch phase when required volumes were difficult to forecast.¹²

FISBA, producer of micro-optics, relied on a long-term OEM relationship to produce exclusively for a German partner. The exclusive partnership lasted about 50 years.

In 1965, **FISBA** initiated a cooperation with **KARL STORZ**, a large German endoscope producer, for which it exclusively produced micro-optics. A modern endoscope must provide a brilliant image of hidden body cavities. The key parameters to be taken into account were light intensity, depth of focus, magnification, contrast and resolution. **FISBA** served as the 'extended work bench' and strategic supplier of micro-optics for **KARL STORZ** until 2016. The focus was on design, which has always been the strength of **FISBA**. For instance, the introduction of the rod lens system created the basis for optimal image transmission in endoscopy, allowing a highly realistic image of the surface and

¹¹Adapted from LEM company profile.

¹²Adapted from Bachem company profile.

structure of internal organs to be produced. This lens system has been continuously advanced and still sets standards worldwide.¹³

Additionally, FISBA collaborated with the European Space Agency (ESA).

Since the late 1980s, **FISBA** had been participating in a series of space projects run by the ESA. The company developed micro-optics for several space missions. The space business contributed less than 1% of FISBA revenues and was generating marginal profits but, through these projects, FISBA was able to generate new knowledge and develop technologies which would later be used in commercial applications.¹⁴

Despite these external collaborations, FISBA always placed a high value on internal technology and R&D. Some CHF 3 to 4 million were invested every year in R&D, and 35 out of 350 employees worked in research and development. In addition, between two to five new patents were filed every year, boosting the overall patent pool to a total of 25 to 30 patents.

FISBA and Acutronic were not the only companies collaborating with space agencies. **maxon** had engaged in such collaboration since the early 1990s.

When the US space agency NASA contacted **maxon** inquiring if its motors could withstand very low temperatures, few could imagine that this would lead to a business relationship that would literally put maxon on the map — and on Mars. It took several years, and visits to Sachseln, until the project was completed, and NASA's 'Sojourner' mobile rover landed on Mars in July 1997, powered by eleven maxon motors. With the nomination of maxon as a preferred supplier, the company gained worldwide notoriety for the reliability and quality of its drives. In 2004, NASA landed two more rovers on Mars, 'Spirit' and 'Opportunity', each equipped with 39 maxon motors. maxon motors were also on the 'Cassini' satellite exploring Saturn, and new projects with NASA were planned. Equally, maxon collaborated successfully with other space agencies.¹⁵

Felco accepted entering a partnership with Stihl, a large German company in related fields and interested in Felco's technologies; this also involved a collaboration in distribution and sales.

In 2014, **Felco** entered a wide-ranging partnership with Stihl of Germany, a world leader in power saws and lawn care machinery. Stihl, who was into cutting big trees, wanted access to Felco technologies and products for cutting small trees and branches. The board management agreed to a partnership that offered important benefits to both companies. Stihl obtained access to Felco's various technologies on an OEM basis and, in return, Felco gained access to Stihl's distribution network. Not satisfied with this trade alone, Felco also asked for, and obtained, access to Stihl's 40,000 point-of-sales worldwide for its tools. The products marketed through Stihl were being co-branded but were produced by Felco and FELCO Motion.¹⁶

¹³Adapted from FISBA company profile

¹⁴Ibid.

¹⁵Adapted from maxon company profile.

¹⁶Adapted from Felco company profile.

Few companies used the cooperation with a single customer to the extent that **Thermoplan** did. Having already made the transition from installing institutional kitchens to developing and supplying automated modules for milk foaming and cream beating, Thermoplan leveraged an intensive cooperation with Starbucks, the world's largest coffee shop chain, to launch a fully automatic coffee machine that was to grow the company more than tenfold in a decade. The connection with Starbucks was made at a fair in 1997 where Thermoplan, a newcomer to the field of professional coffee machines, first showcased its newly developed model, prompting Starbucks to include Thermoplan in their search for new machines.

After an evaluation of several machine suppliers, Starbucks included **Thermoplan** as one of three suppliers in its six month's long testing phase, allocating a site in Vancouver, Canada to Thermoplan. Over this pilot testing phase, Thermoplan managed to constantly adjust and improve its machine, impressing Starbucks both with its flexibility and machine performance. In 2000, Thermoplan signed an exclusive, long-term, global supply contract with Starbucks for all its coffee shops. Remembering the negotiations with Starbucks, CEO Steiner recalled that the contract terms went on and on over many pages and included considerable restrictions for Thermoplan on sales to other customers. For Thermoplan, just two things mattered, the rest was viewed as 'pure legalese'. First, the purchasing terms were in CHF and not in USD, eliminating any currency risk. Second, payments were to be made within ten days after invoicing. This was critical for a company that was sourcing most components from small local suppliers and that way could provide financing to them.¹⁷

That there is a risk in concentrating on one dominant customer was driven home to Thermoplan during the financial crisis of 2008–2009. By that time, the Starbucks business amounted to 70 percent of Thermoplan sales. In the middle of the crisis, Starbucks canceled all its orders, a decision that was alleviated only in 2009 when Starbucks resumed orders at a lower level, allowing Thermoplan to maintain its local component supply chain.

Thermoplan realized that depending on one single account for 70 percent of its sales was far too risky. Around 2010, Thermoplan began systematically to recruit other long-term partners. The UK-based chain Costa Coffee was developed as a partner for custom-made machines. Thermoplan developed a machine for coffee capsules for Nespresso. Partnerships for non-coffee machines were also in development.¹⁸

The experience of the above-cited companies demonstrates both the benefits and the risks of entering into close customer partnerships. These relationships are most helpful when they lead to new products that can be exploited widely and without restrictions. When they are tied to some form of exclusivity, conflict or risks invariably arise until the company entering into those relationships can regain commercial control.

¹⁷Adapted from Thermoplan company profile.

¹⁸Ibid.

Business Model Innovations

Few strategy topics have received as much attention over the past decade as the issue of business models. For the purpose of this book, the authors have adopted some of the original ideas presented by Jane Linder and Susan Cantrell, both with Accenture, in 2001.¹⁹ Following those earlier ideas, the authors have refrained from using business model as a substitute term for strategy and use examples from their research only if they have shown some substantial change among paying customers, or the activity for which payment is received.

Most of the companies covered by this research follow a traditional business model: They produce products and sell them to an established list of customers, receiving payments for manufactured products. A few, such as **Oetiker**, **Sylvac**, **Selectron**, and **Plaston**, started out as subcontractors to larger firms before converting to OEM players or moving on with their own brands. Given that these companies are all manufacturers, the *make and sell* commercial model applies to all of the companies, with a few exceptions involving later innovations.

With many of the documented firms looking back on a long history, it should come as no surprise that some of the companies found that the original business model did not ultimately survive or that additional new business required a different business model. Some of these changes, such as at **Cendres + Métaux (C+M)**, were cumulative, which means new business models were added to the original one as the company ventured into new segments, essentially ending up with four different models supported in parallel.

That the business model adopted when **C+M** was founded would not be suitable for the many new businesses to be added later was understandable and to be expected. To permanently adapt and fine-tune the business model over time, however, would be a challenge for any organization.

At the outset, **C+M** recycled precious metals for clients and resold the refined materials. This model was dominant for roughly the first 40 years of the company's history. As the company evolved, the recycling model remained, but over time became less dominant without ever completely disappearing, as other models were added.

Starting during the first third of the 1900s, the company became involved as a sub-contractor of manufacturing components for the watch industry, still its main customers, during the first 75 years of its history. The sub-contracting model was enhanced by also assuming responsibility for parts and modules, getting involved in design once the materials used went beyond gold and silver to ceramics, titan and steel. For some customers, **C+M** also provided modules and assembly services, taking over an ever-larger role and ever more responsibility.

Expansion into medical and dental markets brought about new tasks and challenges. Added to the material processing and manufacturing steps were new requirements dictated by the dental and medical industries. Clients changed, with dental technicians dominating first, but as the company also became a contract manufacturer and outsourcing partner, new activities

¹⁹Linder J, Cantrell S (2001) Changing business models. Working paper, Accenture.

such as clean room, packaging and logistics were added. Adopting the role of full partner to many medical and dental organizations, C+M also needed to adjust manufacturing, running dedicated cells and processes for individual clients. At the end of this process stood the role as an integrated partner for a full range of customer specific products supplied to fit into complicated logistics chains.

Most of these steps meant that C+M acted in the role of white label supplier where the final user would not know who produced the product. Success in both the dental market, and plans for entering the dialysis segment, opened up the opportunity to act as brand-name supplier, shipping products under C+M -owned brand names.²⁰

Needless to say, managing separate business models under one corporate roof is challenging since the requirements for the recycling, the watch components, and the dental and the medical business operations meant adopting different business models. C+M was a rare example among the firms in the sample.

It is worthwhile to review the experience of **Geistlich**, a company which made the change from industrial bone processing for industrial and construction customers, adhered to for decades, to life as a supplier of specialty bone materials for medical purposes, thereby changing all the elements of the Geistlich business model, from distribution to selling and research, as well as changing all internal processes.

In line with the new orientation of the company, a completely different business model was required. **Geistlich** Pharma customers were now dental surgeons located all over the world, radically different from industrial users of adhesives located largely in Switzerland. In order to reach dental surgeons, the company put its emphasis on direct sales and meeting customers at conferences, thus conducting its business without a formal sales force. At those conferences, surgical procedures could be demonstrated.

To support the educational effort that went into communicating the use of biomaterials for bone enhancement, the Osteology Foundation was created in 2003. A second foundation, the Osteo Science Foundation, was established in 2013 and also supported by Geistlich.

In addition, subsidiary companies were built in key markets. With 95 percent of production exported to some 90 countries, the role of these companies was to provide distribution to the well-defined target market of dental surgeons. Ten such companies were set up.

With research becoming fundamental to the development of **Geistlich** biomaterials, the company established and maintained a large network of scientists across more than 100 universities spread all over the world. In house, the company maintained a highly skilled group of experts in the field of bone regeneration and collagen use, prompting some in the field to refer to Geistlich as the 'Tissue Engineers'.²¹

In a true break from the traditional business of making tools and selling them through distributors, or resellers, **Fraisa** moved to a *Tool Care* model where the company collected used tools and resold them as refurbished tools, clearly a change in business model with the company now getting paid for a different activity.

²⁰Adapted from C+M company profile.

²¹Adapted from Geistlich company profile.

Fraisa came to the conclusion that only added services would protect its business from Asian knock-off competition. Copying at first some strategies adopted by the big German company Wirth, Fraisa rolled out its *Tool Care* model involving tool inventory management to make machining workshops more efficient. The next step led Fraisa into the tool refurbishing business and was a major break from the reseller model. If professionally done, refurbished tools could be used two or three times before the end of tool life. However, this could not be accomplished either by the customers or on customer premises, mandating an external service operation. Fraisa established special collection boxes for used tools on customer premises, provided pick-up with its own trucks and, in 2000, it acquired a specialized company in Langnau i.E. for the servicing of collected tools. This service was also extended into Germany, a major market for Fraisa.²²

The idea of getting into servicing and being paid for it as a freestanding business activity was also picked up by **Jura Espresso Machines**.

At its main site in Niederbuchsiten, **Jura** created an exhibition entitled “Jura World of Coffee” that attracted thousands of visitors each year. Also located on the site was a new service center where consumers could bring in their own machines, have them electronically diagnosed on the spot and scheduled for any necessary repairs. For customer ease, there were 24-hours drop-off and pick-up locker facilities. The company was still experimenting how to make this extensive service capability a self-supporting part of the company.²³

LNS, producer of bar feeders, changed its business model by adding different products to its line, moving from single line marketer to multiple machine marketer and establishing a one-stop service for its customers. The company remained with its established segments, but by adding other related peripherals that worked in the same manufacturing environment as its original bar feeders, LNS extended its business model.

LNS left the OEM CNC machinery suppliers selling their equipment directly to their customers market. LNS concentrated instead on selling its peripherals directly to the installed machine base. The global coverage of sales and service was patterned after the strategy of Mazak, a successful Japanese OEM machine supplier. In 2011, the strategy of becoming a one-stop shop became formalized. LNS thus offered a range of bar feeder models for different levels of automation, as well as a range of chip collection systems, all of them engineered to plug-compatibility for a full range of OEM CNC machinery suppliers.²⁴

When a major innovation takes place, a company can impose an entirely new business model on an entire industrial sector. Such an impact was the result of **Bachem** entering the field of peptides used in pharmaceutical research.

Ever since its founding in 1971, **Bachem** had taken the lead in creating a business model that was new in the life sciences industry. Up to that time peptides had been produced internally by each company; Bachem created the market for a merchant supplier doing business with

²²Adapted from Fraisa company profile.

²³Adapted from Jura company profile.

²⁴Adapted from LNS company profile.

multiple life sciences customers. Over time, the peptide supply moved from being almost entirely captive to about 70 percent merchant based, a major change for the industry.²⁵

For some companies, the new business model could be an add-on propped up on the existing, dominant model and not represent a step-out from a business management perspective. Two such innovative examples were conveyed by **Caran d'Ache** and by **Felchlin**.

Using the internet and social media became ever more important for **Caran d'Ache**. The company believed that 80 percent of the population would look up products on-line and then go to a store. The company therefore opened its own e-shop. Overall, Caran d'Ache was investing about 10 percent of sales in marketing activities. As an extension of this shift in consumer behavior, Caran d'Ache was building concept stores. The company came to the conclusion that its own retail store was needed in Geneva. This was as much for marketing as it was to understand the retail environment by engaging directly with customers. Feedback meetings were held on a monthly basis between retail and marketing staff. The Geneva store was run by Caran d'Ache employees. Other concept stores were franchised with partners in Berlin and Tokyo.²⁶

Felchlin, maker of chocolate couvertures for pastry chefs all over the world, wanted to create a school for chefs. The result was the creation of Condirama as described below. Felchlin's base business of supplying chocolate couvertures to discerning chefs remained squarely a B2B business with the company refraining from selling directly to consumers, with one exception: its factory store where select products were sold to local residents on a very limited basis.

Felchlin marketed complex products that required considerable explanation for the selection of tastes and how to apply them. For this purpose, Felchlin created Condirama in 1988, located in Schwyz, equipped to show professionals how to do it right. The school attracted 1000 to 1500 visitors annually. Swiss customers enrolled in one-day courses and did not require overnight stays. International customers, however, enrolled into one-week courses requiring a residential period. Condirama was run as a cost center. Swiss-based customers, when ordering products, received points, a form of frequent flyer miles, which then could be used to gain access to the courses at no additional cost. International customers, or users, were typically sponsored by their importers for the trip and Felchlin covered local food and lodging during their stay.²⁷

Resting on Laurels Not Allowed!

For SMEs to remain successful, the companies needed to accept that having a good idea once is simply not good enough. A steady stream of innovations is required, and therefore, it is crucial that a company is set up in a way that such new ideas are captured and brought to market as a matter of course. Adopting product platforms

²⁵Adapted from Bachem company profile.

²⁶Adapted from Caran d'Ache company profile.

²⁷Adapted from Felchlin company profile.

can be an enormous aid in generating new ideas, because it focuses the entire company on the process of maintaining and refreshing the platform elements. The active attention of thinking in terms of CAC provides a company with that same discipline. And finally, as has been pointed out, the deliberate innovation around a business model can release additional innovative energy in a company and its staff. The SMEs featured in this research did not set out one special Monday morning to search for new ideas. These ideas were automatically, and at regular intervals, brought forward as per usual, rather than being exceptions to a rule.

Open Access This chapter is licensed under the terms of the Creative Commons Attribution 4.0 International License (<http://creativecommons.org/licenses/by/4.0/>), which permits use, sharing, adaptation, distribution and reproduction in any medium or format, as long as you give appropriate credit to the original author(s) and the source, provide a link to the Creative Commons license and indicate if changes were made.

The images or other third party material in this chapter are included in the chapter's Creative Commons license, unless indicated otherwise in a credit line to the material. If material is not included in the chapter's Creative Commons license and your intended use is not permitted by statutory regulation or exceeds the permitted use, you will need to obtain permission directly from the copyright holder.



Leveraging Strategies

The aim of this final section is to bring together some central themes developed in the earlier chapters and to expand the perspective beyond mere business practices. It is evident to the authors that no SME could survive in the long run without making the very best use of its local resources. Under the umbrella term of *Leveraging*, the authors have collected elements of these resources and how the SMEs applied them. Effective leveraging brings together the necessary resources to sustain and achieve growth; invariably, there are different approaches to this, leading, of course, to different results.

- **22 Leveraging Local Competitiveness**

SMEs operating from a Swiss base are invariably confronted with having to deal with an exceptionally high cost base of doing business. In this chapter, the focus is on how companies can enhance their competitiveness by leveraging particular assets of the local economy, from talents, skills, to industry clusters. The management of the SMEs covered in this book found numerous ways to leverage particular local resources to their competitive advantage.

- **23 Leveraging Resources for Growth**

In many ways, this could be viewed as the book's central chapter. It deals with the different bundles of practices adopted by the SMEs that may have caused different growth trajectories over time. By categorizing SMEs into different Olympic running disciplines, such as *Sprinters*, *Middle Distance* and *Long Distance* Runners, as well as *Steeplechasers*, the authors draw connections between different practices adopted by the firms and their respective growth prospects. An illuminating chart is offered to illustrate this story.

- **24 Role of the Swiss Entrepreneurship Ecosystem**

The central role of this chapter is to step outside the concentration on managerial practice and explore the potential influence of the Swiss entrepreneurship ecosystem on the SME management and behavior of these companies. To what extent are these firms a product of the Swiss ecosystem? And, to what extent can their practices be duplicated in other countries or cultures? The writings of a number of

historians, philosophers, and political scientists offer some perspectives on this fascinating question.

- **25 Epilog: Implications for Public Policy**

Having researched this book over several years and having offered detailed explanations about how a sample of 36 SMEs conquered many different niches in global markets, the authors wanted to offer some thoughts on the question *And What Now?* in terms of possible public policy implications. The list is by no means meant to be exhaustive, conclusive, or even final. Instead, it is offered in the spirit of challenging the readers of this book to give some thought to these issues and articulate their own conclusions.

Leveraging Local Resources

How do SMEs, competing for global export markets, remain competitive when operating, to a large extent, from Switzerland, one of the world's most expensive countries? Data compiled annually by the *IMD World Competitive Report* document that the cost of a single hour of labor in Switzerland is one of the highest in the world, while at the same time productivity per hour is also one of the highest, partially mitigating any cost disadvantage. **Ricola**, the herbal candy maker, serves as an example of a highly automated production practice that many companies have adopted.

Ricola remained attached to its location in Laufen where the entire production took place. Production was organized into two long shifts with most of the employees recruited locally. The efficiency of the production operation, including the use of automation and robots allowed the company to compensate for otherwise higher salary costs compared to neighboring countries. Although Ricola acquired its equipment from external suppliers, the extraction method and tying each step into a continuous flow were proprietary and developed internally. In 2019, Ricola produced 7 billion drops a year.¹

The sharp appreciation of the Swiss Franc versus the Euro and the USD over the past few years created an additional, and particular, problem for Swiss exporting SMEs. At some companies, the exchange rate disadvantage was alleviated by production staff offering to work more hours than they were compensated for on a temporary basis; other companies decided to shift material sourcing to the Euro area; as a last resort, other firms moved some low-skilled, but labor-intensive, production steps abroad. This process has been described in greater detail in an earlier chapter. Here, **Mikrop** serves as an example of the latter strategy.

¹Adapted from Ricola company profile.

Mikrop regarded the relatively high cost of conducting business in Switzerland as a disadvantage. Labor and construction cost, for example, were significantly higher than in other European countries. In addition, Mikrop was hard hit by the ‘Swiss Franc shock’ since 2008. That extraordinary phase of appreciation of the Swiss currency posed a serious challenge to companies which produced primarily in Switzerland, and they could only benefit to a limited extent from cheaper purchasing prices abroad. To counter the high cost pressure in Switzerland, Mikrop outsourced part of its production to Serbia. This strategy was reserved for the production of standardized, basic products.²

Overall, **Mikrop** regarded the framework conditions in Switzerland as very conducive to the development of the company. The high quality of the education system, relatively low and transparent taxes, political stability, and government efficiency were considered major advantages. These positive framework conditions also facilitated attracting talent from abroad.

The high-cost environment, in combination with the shifts in exchange rates for the Swiss currency, put **FISBA**’s profit margin under pressure in recent years. Consequently, the company considered shifting some of its production facilities abroad, but ultimately decided against this move. The general assessment was that, despite a rising administrative burden and high production costs, Switzerland still offered sufficiently competitive framework conditions.

Confronted with the same challenges concerning currency appreciation, **Medartis** management adopted a more accepting view.

At **Medartis**, excellence in engineering and software programming guaranteed top quality and efficiency. Concerning the upward valuation of the Swiss Franc vs. the Euro or USD, the company believed it ‘just will have to deal with it’ and would not consider moving parts of the operation elsewhere.³

For **maxon**, labor wages were not the only basis on which to make cost comparisons. Using another metric put a different spin on the cost comparison game even when labor costs might be much lower elsewhere.

maxon’s growing business in Korea led to the creation of a production unit there as well. Growing out of a successful distribution business, the Korean operation began with producing brushless motors with iron core winding, because winding around iron was easier to accomplish. Later, a robotics operation for iron cores was added in 2013. On a comparative basis, labor costs in Korea were about one quarter of the Swiss level. Despite the wage level differences, the Swiss operation was still competitive on the basis of profit-per-person, the key operating metric used at maxon. The indirect costs at the Swiss operation were about two thirds, with one third for direct production. However, a shift was taking place there as well.⁴

The previous sections of this book covered a range of decisions and actions, typical of Swiss SMEs, that contributed to long-term and sustainable strategies.

²Adapted from Mikrop company profile.

³Adapted from Medartis company profile.

⁴Adapted from maxon company profile.

There were a number of additional practices that Swiss SMEs engaged in to help mitigate the cost disadvantage which are well worth reflecting on. This section will put the spotlight on some of those strategies that struck the research team as particularly noteworthy.

Engaging in Premium Pricing

With a Swiss and therefore invariably a high-cost base, premium pricing is a practice followed by many of the Swiss SMEs simply because the full high-cost burden cannot be absorbed through superior operating efficiency. For some companies, the price differential compared to non-Swiss competitors can be substantial.

- **Felco**, producer of pruning shears, retailed its best-selling, Model 2, for CHF 50 in Switzerland, compared to Asian competitors who were retailing similar-looking products for one-third of the Felco price.
- **Caran d’Ache** priced its writing instruments at about 20 to 25 percent above their major competitors.

Despite these considerable price differences, both Felco and Caran d’Ache thrived over a long period of time. Management at both companies has learned to argue the value of the products, in addition to how, and why, their quality can justify such considerable price differences.

For **Caran d’Ache**, perfection in its products allowed it to issue a lifetime guarantee for its writing instruments. It combined sustainability processes with superior quality and was able to list quality along a number of dimensions. Its built-in ‘air bags’ worked as shock absorbers for pencils when dropped. The pencil sets in boxes could be refilled with single pencils and the pencil boxes could be reused for other purposes. The company used twice as much gold as competitors to plate and emboss its pens and offered repairs or refills. All of these elements contributed to lowering the life-time cost to the user while adding superior functionality and durability.⁵

For **Felco**, competing at times with prices three times higher than those of low-price competitors meant being able to articulate a justification for the premium price. In Felco’s case, this was primarily taking a longer view—providing a product that clients could use over many years and, in effect, amortizing the cost for the consumer over a lifetime and therefore lowering it.

Felco products had to meet the highest quality standard. Three factors were the basis of this superiority: ergonomics, parts inter-changeability and durability. On all three counts, Felco argued, its products were superior to competing makes. Ergonomics was critical from the users’ point of view. In vineyards, plants had to be pruned during a limited time window, with professional pruners in large vineyards performing thousands of cuts a day. Felco

⁵Adapted from Caran d’Ache company profile.

pruning tools could withstand 10,000 cuts a day without causing injury to the user's hand. Comfort for the pruner's hand, as well as minimum weight, and a spring that resulted in effort reduction, were critical.

Felco's principle of inter-changeability resulted in a modular design where individual components were replaceable and could easily be changed when worn out. Inter-changeability over a long service life of pruners could only be achieved if production was of high precision that assured identical parts, even if produced years apart.

Durability was a requirement for long-term use. Felco products were made to last, to be passed on from generation to generation rather than treated as a tool with an expiration date. To achieve durability, and to allow the company to issue a life-long guarantee, only the most exacting manufacturing processes and materials could be used. The best possible pruning products included precision in pruning which also guaranteed "quick healing of the pruning wound," eventually resulting in higher yields for the farmers.⁶

Both **Felco** and **Caran d'Ache** developed elaborate argument threads to change customers' inclination to compare initial acquisition cost and consider the long-term running cost instead, or alternatively the long-term ownership cost. What might appear to be a premium price when comparing initial purchase prices was, in fact, considerably below those of the cheaper, competitive models when the long-term ownership cost for the products was taken into consideration.

Fraisa, maker of cutting tools, was confronted with lower-cost imports from Asia. It responded by creating a tool service, described earlier, which had also an impact on the ownership costs of its tools, compensating for an otherwise high up-front acquisition cost:

Fraisa entered into the tool refurbishing business as a major break from the reseller model. If professionally done, refurbished tools could be used two or three times before the end of tool life. Fraisa established special collection boxes for used tools on customer premises and provided a pick-up service by its own trucks.⁷

Pilatus, producer of private planes, was operating at the opposite spectrum of unit pricing with its executive jets priced at several million Swiss Francs. Its argument that the PC-12 was a low-cost choice over the long run, included the resale value of its planes, as well as an aircraft layout that reduced time and costs for maintenance.

Certified for single pilot operation, the **Pilatus** PC-12 became the plane of choice for owner-flown executive pilots. Due to its versatility, it could be used for passenger operations, as an air ambulance, for cargo transport, or for special government missions. Strong demand came from the US where most planes were delivered in executive configurations. The price of the PC-12 had risen over time with improvements and reached about USD 5 million (2017). This price was competitive due to its reliability and the fact that the resale value of PC-12

⁶Adapted from Felco company profile.

⁷Adapted from Fraisa company profile.

models retained a higher level compared to competing models. The PC-12 engine layout was designed for ease of maintenance and for other key parts to be easily replaced and accessible for mechanics.⁸

Throughout our interviews, Swiss SMEs consistently mentioned that maintaining superior quality standards was a key ingredient to their success. Quality as a competitive element requires the ability to painstakingly document it, make it tangible to customers, and surpass competing offers. At times, this takes the form of a long service life, superior precision, exceptional workmanship, or simply in terms of the fact that the product *really works!* Superior quality is a key element to justify a price premium. Stringent quality control was widely employed, regardless of whether part, or all, of the production was offshored.

When **Mikrop** established a subsidiary in Serbia in 2007, the company had been able to transfer specific technical knowledge in optics production, with the effect that many processing steps of production took place in parallel in Serbia. This allowed Mikrop to offer attractive pricing in line with market expectations. Review and final inspection were always done at Mikrop's main production site in Switzerland, thus guaranteeing the high Swiss quality standards customers had come to esteem.⁹

As a small player in the field of metrology, **Sylvac** benefited from its singular focus on measurement tools and devices in order to compete against larger, lower-priced competitors from China and Japan.

Sylvac leveraged its measurement accuracy and IoT connectivity. Reliability as perceived by the end user was critical. Users had to rely on the results of their measurements, which required trust.¹⁰

FISBA, in optics, used its emphasis on quality to deter larger players from entering the market space.

FISBA's production expertise combined with its focus on quality leadership, as well as its focus on securing a niche, led to the company's strong market position and created certain entry barriers for possible new entrants. For bigger players, the market was relatively small compared to the investments needed to provide high quality products; and, for smaller players, the high costs to enter that market were often prohibitive.¹¹

As demonstrated by **Caran d'Ache**, the use of a sustainability strategy could also be used as a differentiator to add support for a price premium.

Caran d'Ache also wanted to differentiate itself through its sustainability strategy, that, while adding costs to the production, were of value to end-users and society at large. The

⁸Adapted from Pilatus company profile.

⁹Adapted from Mikrop company profile.

¹⁰Adapted from Sylvac company profile.

¹¹Adapted from FISBA company profile.

wood dust from its cedar wood production was collected and used to heat the factory. Water-based varnishes on the pencils took longer time to dry while the competition was still working with solvent-based materials. The wood used for its pencils come from strictly managed forests. Throughout its manufacturing processes, Caran d'Ache took exceptional care to use healthy materials. Caran d'Ache received recognition for its quality processes and sustainability efforts from a number of certifications agencies. Its environmental management was certified by ISO 14001.¹²

In general, Swiss SMEs found ways to combat the impact of a high sticker price by softening its impact through a number of strategies to enhance value-in-use, in effect lowering the customers' long-term cost-in-use. At times, this long-term cost even went below the competitive offers that came on the market that had a lower sticker price and inferior performance.

Leveraging Core Competencies and Skills

The principle of a firm's core competence as a source of competitive advantage has been an often-cited concept in management theory. Its proponents describe it as "a harmonized combination of multiple resources and skills that distinguish a firm in the marketplace."¹³ The practices of Swiss SMEs reflected this principle, and many companies leveraged this idea to achieve a competitive advantage, although it may take different forms.

Acutronic built its entire value chain around its core competencies of engineering, electronic, and assembly, while leaving other, noncore, activities to partners or outsourcing them.

The core competency of **Acutronic** was the development, design and assembly of precision motion simulators. The company still built its own power amplifiers and controlling-related technical parts in-house, because there were no products on the market that satisfied the company's needs. Control loops and engineering know-how was crucial, due to the high accuracy requirements in the industry. Despite the fact that most other parts used for Acutronic's products could be bought off the shelf, it was very hard to reach the accuracy and performance of the company's products. On the other hand, the company's focus on its core competencies led to the outsourcing of most of the production activities. The company sourced a big portion of all non-critical parts from external suppliers and focused on its engineering and electronics, as well as assembly competencies. By doing so, costs were kept low and the company was able to stay competitive. Because of efficient processes, the costs per unit at Acutronic were still comparable with competitors in other countries, despite the high labor costs in Switzerland.¹⁴

¹²Adapted from Caran d'Ache company profile.

¹³Prahalad C, Hamel G (1990) The core competence of the corporation. *Harvard Business Review* 68(3): 79–91.

¹⁴Adapted from Acutronic company profile.

For core competencies to be of competitive value, they have to be honed and constantly reinforced. One of the most extreme examples of this was found at **Caran d’Ache** where the competencies were broken down into many steps, supported by its own equipment and which covered many different trade skills and raw materials.

Carole Hübscher, Chairwoman of the Board of Directors, likened the **Caran d’Ache** manufacturing process for graphite “dough” for pencil cores to “cooking, similar to pasta or baking bread.” It involved 35 different steps and the company owned about 800 different pieces of manufacturing equipment, many designed by the company itself. An inventory of skills determined that Caran d’Ache staff exhibited about 90 different skills, ranging from lead dough preparation to lead manufacturing, to the management of colors for pencils, as well as covering knowledge about different materials, from metal to plastic and wood. Base skills required originated from chemistry, mechanics, wood working and lacquering.¹⁵

Sometimes, the core competencies arrive with the skills of the company founder. This was the case at **Kuhn Rikon**, producer of pans and cooking utensils, where the founder’s competency had previously been acquired in the French mining industry; this experience became key to the company’s founder navigating change in the industry.

Kuhn Rikon founder Heinrich Kuhn soon realized that the rapid change from wood fired to electric stoves would require different kind of pans. On a wood stove, the shape of the bottom did not matter. With the emergence of electric stoves, absolute flatness of the pan’s bottom was essential. As an engineer, Kuhn knew how to roll flat walls from aluminum sheets. Aluminum, then still a new metal, also provided excellent heat conductivity essential for electric hot plates.¹⁶

Although most companies did not formally communicate their core competencies to the public, there was one instance at **Ricola** where the company found that demonstrating its core competence as “herbal competence” added greatly to its credibility with the general public and its consumer base.

Demonstrating its herbal competence, **Ricola** created five herb gardens in the Swiss mountain area to show the 13 central herbs to the public. By the early 1980s, the success of Ricola sales began to outstrip its supply of herbs, which up to that time came mostly from the local area. The company connected with over 100 contract herbal farmers in the Swiss Jura and mountains, encouraging them to plant the herbs on contract. Ricola provided the seeds to farmers. The total plantation area amounted to an equivalent of about 124 football fields and yielded 1400 tons of fresh herbs each year. Herbs were dried immediately in the various mountain regions, then put in bags and shipped to the Ricola herb center for further sorting, drying, cleaning and mixing with other ingredients.

The **Ricola** herb center was a large, dedicated facility where a number of herb processing steps took place. From the dried herbs, natural essences were extracted and mixed with other ingredients. This mixture was then cooked and molded into drops and pearls and left to cool. Processing the dried herbs to create the 13-herb base mix was seasonal and extended over

¹⁵Adapted from Caran d’Ache company profile.

¹⁶Adapted from Kuhn Rikon company profile.

only three to four months. To assure a continuing flow for further production, the company stored herbal extracts for several months. Each year, Ricola processed about 250 tons of dried herbs.¹⁷

Core competencies are also shaped over time and can develop gradually. An excellent example of accumulating such skills that then grow into a core competence is provided by **Pilatus**, the general aviation aircraft builder. Its present competence evolved over more than 60 years.

Pilatus' evolution from a maintenance role into assembling and subcontracting parts to become a full-fledged developer and builder of competitive training or civil aviation planes, including jets, did not happen overnight. At each step, the company gained valuable experience which was added to earlier steps. Over time, Pilatus had accumulated the complete experience needed to become an airplane designer and building company.

The ruggedness of its earlier training models was carried over into its civil aviation models. Experience with maintenance was capitalized by building planes for easy maintenance. The need to provide multiple variations of the same model series led to experience with modularization. The experience with STOL in the PC-6, its first civil aircraft, was rolled over into its PC-12 and PC-24 executive airplanes, allowing for the utilization of thousands of small and ill-equipped civil airports in rural regions.¹⁸

Core competencies are not acquired from one day to the next or as a result of a single invention or innovation. They are accrued over time, often over years or decades. For most of the researched SMEs, these competencies became an essential element of their winning practices as they competed for global markets.

Leveraging Talent

In a country where unemployment is traditionally low and where industry relies to a considerable degree on employing staff from mostly European and neighboring countries, the scramble for talent was a recurring theme in the company interviews. Attracting the right workforce was a particular challenge for those companies located outside major urban centers, where the majority of the SMEs in the sample were headquartered. To alleviate a constant shortage of qualified employees, companies employed various strategies to attract talent, but more often invested a considerable amount of resources to grow talent in-house.

¹⁷Adapted from Ricola company profile.

¹⁸Adapted from Pilatus company profile.

Recruiting Talent in Urban Centers

The challenges for attracting talent faced by SMEs differed to a considerable degree by their location and to the extent that the urban centers could provide the required skill set. Both **Medartis** and **Bachem** benefited from the richness of the Basel region for health and life sciences talent, as well as the closeness to Germany and France. However, the two companies employed different strategies when it came to tapping into the cross-border talent pool.

Medartis with its operation in Basel could tap into the regional supply of top talent for mechanical engineering and software development. *Their commitment is exceptional. This talent would not be transferable to China* (Miesch, CEO).

Despite its closeness to the German and French borders, the company employed few border commuters in its operation. When it came to staff its managerial and governance positions, **Medartis** could select from a pool of former executives with sound experience gained at Stratec/Synthes medical implant operations, as well as from the US firm Stryker, and Straumann Dental.¹⁹

Bachem found the necessary talent for its main operation in Bubendorf by competing with large Pharma companies in the greater Basel region. The competition for talent led to higher salaries at Pharma companies, often forcing Bachem to recruit its workforce across the border from Germany. Some 40 percent of the Bubendorf workforce were German nationals, and of those half commuted daily across the border. Given the scientific nature of the Bachem business and its industry, the company executive committee was dominated by executives with strong academic credentials and strong experience in the life sciences industry.²⁰

A contrasting experience was offered by **Caran d’Ache** finding itself in the midst of a large urban center, Geneva, but in need of some very specific skills and talents that were not necessarily in ample supply.

For **Caran d’Ache**, with about two thirds of its staff involved in production, finding the right talent was important. In the Geneva region, there was access to talent steeped in manufacturing around metal, such as for the watchmaking. But for many of the Caran d’Ache processes, staff had to be trained in-house with retention being an important consideration. On average, employees had been with the company about 15 years, with some as long as 40 to 50 years. Although the company participated in apprenticeship programs, for core manufacturing processes only in-house training would suffice as there were no other employers with similar needs in the region.²¹

¹⁹Adapted from Medartis company profile.

²⁰Adapted from Bachem company profile.

²¹Adapted from Caran d’Ache company profile.

Recruiting Talent to Rural Areas

For those SMEs that were larger than average and located in rural areas, the challenge was to convince prospective staff to make the move, either through a daily commute or to relocate closer to the company altogether. Success at expanding their recruiting radius beyond their local region determined much of their ability to attract staff.

With **Thermoplan's** growing operations concentrated on a single campus with several adjacent buildings in Weggis on Lake Lucerne, attracting suitable talent was an important role for top management. For engineering and development positions, Thermoplan relied on its relationships with regional universities of applied sciences, as well as with universities such as ETH Zurich. Weggis was not served by a rail connection, and employees were either using local bus services to get there or, in most cases, used their private cars. This tended to affect the recruiting radius for talent.²²

For its talent recruiting, **Komax** undertook considerable efforts to recruit employees on a regional basis. Access to private or public transportation helped attract employees beyond the local region and Komax could tap into the market for talent in the Cantons of Zurich, Zug or Aargau. The company found that being the market leader and experiencing considerable growth was an important aspect to attract employees. For many areas, employees with a combination of technical and commercial or business background were of particular interest to Komax, such as managerial talent who had earned an EMBA on top of initial technical qualifications.²³

maxon, with its operation based in Sachseln in central Switzerland, attracting the right and sufficient talent for the company was a major concern for top management. Aside from recruiting from its internal apprenticeship program for production staff, development and research talent were recruited from the leading Swiss engineering schools. With expanding volume, the business unit for mechatronics and dental applications were concentrated in Sexau, Germany. *The mentality in the Schwarzwald region of Southern Germany is similar to Switzerland, making collaboration and integration of operations easier* (Eugen Elmiger, CEO).²⁴

The examples of Thermoplan, Komax, and maxon demonstrate that a big factor in attracting talent away from urban to regional centers was the ease of commuting. The ability to access good public transportation to travel to the company locations was important; this put the firms in remote areas, and hence further away from the urban centers, at a disadvantage.

Smaller SMEs located in rural areas were the most adversely affected in the hunt for talent. They could, however, be the most successful if they concentrated on hiring regionally, seeking employees who lived locally and actually preferred to work close to home. Both **DC Swiss**, maker of threading tools, and **Wyon**, producer of rechargeable batteries, were examples for companies which played this card.

²²Adapted from Thermoplan company profile.

²³Adapted from Komax company profile.

²⁴Adapted from maxon company profile.

DC Swiss, located in the small town of Malleray in the Jura part of the Canton Berne, recruited its talent from the region, including the cities of Biel/Bienne and Delémont. The manufacturing skill required was ‘grinding’, and even a trained machine operator needed three to six months to master it. Hiring was by word of mouth and staff turnover was relatively low. There was always a risk of losing good staff to major manufacturers who would recruit young staff away from DC Swiss at significantly higher salaries. The company did not actively hire workers from across the Swiss border, as those employees were viewed as not having the same work culture as the Swiss.²⁵

Wyon, located in a small town in Appenzell, made the best of its rural location by concentrating on the recruitment of highly talented staff who appreciated a rural lifestyle and working close to home and family.

For **Wyon**, starting up production, and growing the company and its leadership team, presented a special challenge, especially in a rural place like Appenzell. Because of their special requirements, Wyon had to train people for quite some time. Wyon was looking for people who had at least completed an apprenticeship in a related area. The reason for this was Wyon’s strong focus on quality and its belief in the higher reliability of qualified personnel. Wyon employed staff with diverse backgrounds, from poly-mechanics to electrical engineers, aeronautical engineers, chemists, automation engineers and software engineers. So far, filling an open position had not been a problem. There were many people in the Appenzell with a good education who were not able to find a job there. The people from Appenzell felt close to their region and wanted to work not far from where they lived. Wyon enjoyed a good reputation in the area and rarely advertised for a production employee. Simply spreading the word within the company led to enough suitable applications. Fluctuation was also low. Most employees came from the local region and a large part of the staff even went home for lunch, as was common practice in rural Switzerland. However, at some point Wyon might reach a critical size and may need to recruit more people from outside.²⁶

How far a company can go to find suitable staff and how improved public transport to rural operations can improve hiring are illustrated by **Kuhn Rikon**.

When **Kuhn Rikon** experienced difficulties hiring production workers in the early 1960s, the company simply built factory housing next to it. However, even that did not alleviate the recruiting bottleneck. When a large group of Tibetan refugees arrived in Switzerland around that time, the company offered its housing and successfully managed to recruit among them, and even assisted with building a Tibetan monastery in the area. Today, some 14 different nationalities are represented among its workforce, including descendants of the initial Tibetan refugees. More recently, talent hiring was alleviated by the opening of a new S-Bahn (suburban railway) connecting Rikon via a direct line to Zurich Main Station.²⁷

²⁵Adapted from DC Swiss company profile.

²⁶Adapted from Wyon company profile.

²⁷Adapted from Kuhn Rikon company profile.

Growing Talent Internally

Common to all SMEs was the special emphasis on growing their own talent, particularly through participation in the apprentice system. Sometimes referred to as a dual system, combining practical training with part-time schooling, the apprentice system was particularly well represented in Switzerland. The number of students finishing their education with a Certificate of Maturity, or equivalent to the German Abitur, was at about 30 percent of graduates, a very low proportion compared to other OECD²⁸ countries. Below is a selective list of companies and their engagement in apprenticeship programs.

- **Sefar** trained its own apprentices in weaving because only few apprenticeship programs were left.
- **Thermoplan** maintained 14 apprentices in its Weggis operation for a variety of professions.
- **EAO** was a firm believer in the dual systems and offered apprenticeships in 18 different sectors.
- **Acutronic** participated in apprenticeship programs to train its own future workforce.
- **Caran d’Ache** participated in apprenticeship programs including for core manufacturing processes.
- **Sylvac** offered several apprenticeships in collaboration with other local firms.
- **Komax** had almost 50 apprentices in training in Switzerland with another 25 in Germany, where the dual system was also popular.
- **FISBA** invested heavily in the development of apprentices to replenish the pool of skilled employees, with 29 apprentices out of a staff of 350.
- **maxon** engaged about 50 apprentices in its Swiss factory.
- **Pilatus** enhanced its highly skilled workforce through an extensive apprenticeship program with more than 130 apprentices in many different fields training within the company.

The diversity of the companies mentioned, in terms of size, industry, and location, speaks to the pervasive support of the apprenticeship system among Swiss SMEs. That the larger companies can, and do, commit larger resources to this is easily understood. The reason for undertaking this effort, however, also lies in the understanding that such a practice will train the talent of the future and that without such an undertaking, the supply of skilled employees might shrink.

- **Komax** offered apprenticeships in polymechanics, engineering design, automation, and commercial areas. It was important for Komax to be able to hold on to promising staff members once they completed their apprenticeship.

²⁸Organisation for Economic Co-operation and Development.

- For **maxon**, as an operation based in Sachseln in central Switzerland, attracting the right and sufficient talent for the company was a major concern of top management. It engaged in an extensive apprenticeship program with about 50 apprentices enrolled at any time. The company was considering expanding to up to 100 apprentices, which would mean an expansion of the geographic range and the need to build a residence, similar to a university dormitory, so that apprentices can stay during the week, significantly increasing the recruiting radius.
- **Pilatus**, the largest company in our sample—with 2000 employees in Switzerland, it is also the largest employer—had more than 130 apprentices on its site and offered three- or four-year programs in a multitude of professions, such as sheet metal mechanics, electricians, lettering designers, IT specialists, production mechanics, and polymechanics. Since 1942, when the company began with apprenticeships, some 1300 apprentices graduated from its programs and about one-third of them stayed on to become employees. Programs were also offered to students of ETH Zurich who had to complete a six-week practical internship as part of their degrees and for engineering students who could complete eight of the 12 months of practical experience at Pilatus required for their degree.

DC Swiss, a smaller company, was a relatively big player in the apprenticeship game. To be both more effective, and to offer a more attractive program, the company joined up with other firms in the region, including **Sylvac**, which is described below.

For **DC Swiss**, an important aspect of talent management was the participation in apprenticeship programs. The company employed about 15 apprentices for three- to five-year apprenticeships. An important feature was the polymechanic apprenticeships offered in conjunction with several other local firms that resulted in a broader training than one offered by a single firm only. Apprentices were rotated among five other participating firms. These apprenticeships were for young people, after completing the required nine years of education, interested in joining the DC apprenticeship programs.²⁹

The impact of regional cooperation and the benefit of a cluster of similar technologies were also exploited by **FISBA** and other firms, both for regular talent and for apprentices in particular.

Recruiting adequately trained employees for its operations was one of the principal challenges faced by **FISBA**. However, thanks to the collaboration with other optics manufacturers in the region, there was a pool of talents in Eastern Switzerland. All these companies were located around St. Gallen and the Rhine Valley and they were training their own apprentices in precision optics. Upon completion of their apprenticeship, some of those highly qualified workers would often remain in the company while others would join another optics manufacturer in the region. Over the years, FISBA recruited and built talent via the

²⁹Adapted from DC Swiss company profile.

apprenticeship scheme and in-house training, and from universities and technical colleges, both in Switzerland and in neighbouring Germany. FISBA invested heavily in the development of apprentices to replenish its pool of skilled employees. Not surprisingly, 29 of FISBA's 350 staff were apprentices. In addition, the company invested in its workforce by encouraging ongoing education and training at technical institutes. The most promising employees could then become experts in optics design and photonics.³⁰

At some companies, the training of skilled staff went beyond young apprentices. Scarcity of talent encouraged some firms to pursue nontraditional paths to upgrade its workforce. **maxon** began to enroll some of its lower-skilled female workforce into its technical apprenticeship programs to upgrade their skills. **Fraisa**, the milling toolmaker, offered such a formal apprenticeship program to long-serving production staff who had never been given a chance to obtain a formal certification when they entered the workforce.

Fraisa maintained an active apprenticeship program for manufacturing jobs. Of equal importance was the extension and enhancement of qualification of its older workforce, many of those had not completed a apprenticeship and yet were valuable members of the company. The experience of lesser qualified members of the workforce searching for new jobs during the financial crisis led Fraisa to adopt a widely recognized apprenticeship program for non-skilled workers. Since 2012, 22 production employees graduated from the program with a Federal Diploma equivalent to that offered for younger staff in regular apprenticeship programs, with half of them 50 years and older. This program allowed previously less qualified workers to keep up with the requirements of Industry 4.0 and IoT developments on the shop floor.³¹

Apprenticed Managers

The support of the Swiss apprenticeship program, or dual educational system, has a long tradition. Apprenticeships can also be a steppingstone to future executive positions as the examples of many of the current SME leaders demonstrate. Many of these *apprenticed managers* followed up their initial training with degrees from either Swiss technical schools or universities, or with a degree in business from a number of executive MBA programs available in Switzerland. The following are a few examples (not complete) from the interviews.

- Eugen Elmiger, CEO of **maxon**.
- Willy Miesch, CEO, and Thomas Straumann, Chairman, of **Medartis**.
- Eric Schnyder, CEO of **Sylvac**.
- Hans Oetiker, founder of **Oetiker Group**.
- Jean-Pierre Etter, founder of **LEM**.
- Adrian Steiner, CEO of **Thermoplan**.
- Peter Grogg, founder of **Bachem**.

³⁰Adapted from FISBA company profile.

³¹Adapted from Fraisa company profile.

The careers of these company founders and top executives are living proof that stepping into an apprenticeship is not a dead-end street; it can be a first step toward a business career. These leaders, due to the nature of their training and skills, are very close to the technical aspects of their companies and are one of the reasons for the practical orientation of Swiss SME management.

Leveraging Institutions of Higher Education

This section would be incomplete if it did not mention the role played by Swiss universities in the education of talent, as well as their collaboration with companies on special projects. A strong role was played by ETH Zurich and EPF Lausanne, the two federal institutes of technology. Both institutions rank in the top 20 research universities worldwide and the only ones in that group located in non-English-speaking countries.³² Several of the current leaders of SMEs researched are graduates from either of the two. Furthermore, a large number of the board of directors of the SMEs that went public are also graduates of these two federal institutions.

In 1997, three PhD students at the ETH Zurich, Daniel Ammann, Andreas Thiel, and Jean-Pierre Wyss, all under the supervision of Professor Gerhard Tröster, Professor for Digital Systems and Wearable Electronics, decided to leave their academic studies to start **u-blox** for the purpose of developing and marketing electronic modules for producers of communications systems, with early emphasis on miniaturized GPS receiver modules. They left the ETH academic program with an MA Diploma in hand.³³

Larger Swiss SMEs who maintained more formal research and development staffs often recruited graduates from these two institutions, although not exclusively. And as Eugen Elmiger, CEO of maxon, confided, some of these ETH graduates, upon joining the company, realized how much they had missed out on by not going through an apprenticeship program first, referring to skills that were later difficult to make up for.

A second important source of talent was the Universities of Applied Sciences (UoAS, Fachhochschule) clustered in several regional groupings with campus facilities in various smaller Swiss cities. The UoAS included a range of traditional locations with specialties that remain relevant to this day. Among the campuses mentioned most often were Yverdon, Neuchâtel, Biel, and Le Locle in the French-speaking part of Switzerland, and Burgdorf, Olten, Windisch, Luzern, St. Gallen, and Buchs in German-speaking Cantons. Frequently, companies ran research and development projects in conjunction with these technical universities.

³²“QS University Ranking 2020,” ETHZ No. 6; ETHL No. 18.

³³Adapted from u-blox company profile.

- **EAO** had executed projects at two regional Universities of Applied Sciences, in Olten, where a large campus existed, and in Windisch, where the plastic molding program was very strong.
- **Sylvac** often recruited electronic and software developers from the technical programs at HES in Yverdon.
- **Mikrop**, leveraging the optics and photonics cluster in the region around St. Gallen, had developed a tradition of collaborating in the field of education and training. For example, the companies in the optics cluster jointly developed a study program in optics and worked together on a range of projects with the Institute for Production Metrology, Materials and Optics at the local University of Applied Sciences of Eastern Switzerland.

Rüeger, located not very far from EPFL Lausanne, offered an example about how these technical institutions can be leveraged to generate new technical and business ideas.

Rüeger maintained active contacts with regional technical universities, such as with EPFL Lausanne in the areas of new measuring technologies, as well as HES St. Imier and HES Yverdon, that graduated technical talent of importance to Rüeger. In 2008, Bernard Rüeger, then CEO of Rüeger, managed to acquire a start-up firm connected with EPFL and integrated it later into the Rüeger company. Started in 2003, by an independent inventor who used his experience in the field of deep oil-frying in the fast food industry as the basis for his PhD, he developed a system to measure the quality of frying oil through temperature, intended for deep fry makers. The start-up had difficulty in reaching industrial scale. The market leader in this equipment already had its own solution, but another competitor was looking at a system for integration into its deep-frying equipment. Eventually, Rüeger granted a license for the US market, with sensors made for Europe produced in Crissier.³⁴

For talent trained in business, the leading university tapped for recruiting was the University of St. Gallen, the source for talent in finance, administration, and marketing. A large number of business leaders and executives in Swiss SMEs, however, went the dual route, starting as apprentices, then got a technical degree from a UoAS, and followed that with a part-time EMBA program offered by regional institutes. Many companies preferred the route of first acquiring technical training and then following that up with a shorter training period in business administration. MBA graduates from international business schools were the exception.

Leveraging Entrepreneurship Among Employees

Employees at Swiss SMEs do not typically assume the roles of owners or managers. However, the example at **Selectron** shows that under the right conditions, employees can very well step in and, in due course, affect the survival of a company. Prompted by its then owner, the Schneider Group, to find a buyer, Selectron failed to

³⁴Adapted from Rüeger company profile.

secure a deal. Its CEO, Emmanuel Hannart, then convinced the staff to follow him into an employee buyout with great success.

When the sale to ABB failed, Hannart, **Selectron** CEO, took another look at the buyout option. Working with business contacts and private investors, he and his advisors put together a package for the employees, not just managers, to buy the company. Schneider agreed to sell at the same price previously negotiated with ABB and to grant more time to put the deal together. Banks, after first balking at the idea of a leveraged employee buyout, agreed to finance about 60 percent of the acquisition price. For the 40 percent equity required, 75 percent was contributed by a group of international investors recruited by Hannart and the remaining 25 percent came from employees, 80 percent of whom voluntarily decided to invest. The deal went through in July 2009.

With 46 of staff investing CHF 1.25 million, collectively, in their company, the effect could be felt across the entire staff. Hannart found himself in meetings explaining multiple times the difference between cash flow and profits, the terms of EBITA, the concept of leverage and many other financial concepts that were new to his mostly technically trained staff. With newly found independence, Selectron continued to grow. Strong business results allowed the company to quickly pay off the bank loans from the leverage buyout.³⁵

The Selectron experience serves as an example that technically trained employees with little formal business background can be motivated to assume considerable business acumen.

Leveraging “Swissness”

Swissness turned out to be one of the few hotly debated subjects in many of the interviews. The cause of the controversy was created by a new regulation passed by the Swiss government, concerning the right to use the designation *Swiss*, which had been put into effect in 2017. This new regulation effected trademark protection and the right to use the coat of arms of Switzerland.

Since most of the SMEs documented here were producers of industrial products, the change in regulation affected many of these companies directly. The new regulation in effect required that, for a company to use the *Swiss* label and coat of arms, at least 60 percent of the cost, including R&D costs, had to be realized in Switzerland. In addition, the process stage that conferred the product its essential characteristics also had to take place in Switzerland. Exceptions were granted for raw materials or semi-finished products not available in Switzerland.³⁶

Swiss SMEs considered the use of the Swiss label to be a competitive advantage because it conveyed a combination of quality, precision, competence, and reliability to customers worldwide; it also helped justify a premium price dictated by higher operating costs incurred in the country.

³⁵ Adapted from Selectron company profile.

³⁶ SME portal for small- and medium-sized enterprises. Swiss Confederation www.kmu.admin.ch. Accessed February 2, 2020.

For companies which relied heavily on Swiss manufacturing, the change did not require a change in strategy. **Medartis**, with complete production in Switzerland, could continue to rely on *Swiss Made*. So did **Thermoplan**, producer of automated coffee machines; **Jura**, the maker of home espresso machines; **Felco**, producer of pruning shears; and **DC Swiss. Caran d’Ache**, with its existing production near the French border, took the regulation into consideration for its relocation to preserve the Swiss label.

When the original **Caran d’Ache** site in central Geneva, where the company had been located since its creation, became too small for the growing business, a new site was developed in 1974 in Thônex at the edge of the city of Geneva. However, the area around the complex developed into a residential area, making it increasingly difficult for the transportation and delivery activity of about 20 trucks daily. The company was therefore planning to relocate to yet another site in Geneva that offered space for future expansion. Caran d’Ache was committed to remain and produce in Switzerland, eliminating the option of moving across the border into nearby France. The label *Made in Switzerland* required a Swiss production site.³⁷

Felchlin, producer of chocolate specialties for the pastry trade, was also subject to the *Swissness* regulation governing food companies, where imports for foodstuff not available in Switzerland, such as cocoa beans, were excluded from the local value-added regulation.

In its international marketing activities, **Felchlin** was able to exploit *Swissness* as it met the 60 percent limit for value-added in Switzerland. In its publications, the company did not see a need to display much of the Swiss flag. Word about Felchlin was also spread by a small group of key account managers located in Dubai, India and North America who worked with key customers in the roles of Felchlin ambassadors.³⁸

For SMEs who could not measure up to the 60 percent Swiss content requirement, changes in the Swiss claim were required. For a company such as **Sylvac**, the use of non-Swiss caliper blanks resulted in the loss of the full *Swiss made* label. The same issue was requiring changes at **Rüeger**.

The debate about what constituted *Swiss Made* was of considerable importance to **Kuhn Rikon**.

After **Kuhn Rikon** in-sourced products from outside of Switzerland, the products could no longer be claimed to be *Swiss Made*, and the company, after several false starts, moved towards a differentiated labeling of its product line. The cookware made entirely in its Rikon factory continued to be labeled as *Swiss Made* and the use of the Swiss flag was authorized. The company’s kitchen gadget and utensil line could no longer be sold under that label, even if it were brought back to Switzerland and packaged there. Like other firms, Kuhn Rikon changed to label its products as *Swiss Designed*, but had to forego the use of the Swiss flag on its packaging.³⁹

³⁷Adapted from Caran d’Ache company profile.

³⁸Adapted from Max Felchlin company profile.

³⁹Adapted from Kuhn Rikon company profile.

The change in definition of *Swissness* forced several SMEs to change their reliance on *Swiss Made* to adopt other forms of *Swissness*. Similar to Kuhn Rikon using the term *Swiss Designed*, **Burckhardt Compression** and **Sécheron** used the term *Swiss Engineered*. For customers of both of these engineering firms, it was an important feature that final assembly of the equipment took place in Switzerland, so that the effective term was then a form of *Swiss Assembled* (authors' terminology), or in the case of **LEM**, the use of *Swiss Company* was sufficient for the customer base. The change in the legislation about the use of *Swiss Made* had unleashed a large number of variations in how *Swissness* could be leveraged.

Leveraging Industry Clusters

The value of industry clusters in developing competitiveness for their members was brought to the attention of strategists by Michael Porter and his research.⁴⁰ According to the cluster concept, companies can benefit from the presence of similar firms in close proximity. Potential cluster benefits were discussed with some of the SMEs in the interviews.

Both **FISBA** and **Mikrop**, active in the optics industry and located in the St. Gallen area, commented positively on their cluster experience.

FISBA could benefit from a strong industry cluster in optics and photonics which had emerged after WW II. The pioneer companies were Wild Heerbrugg and Balzers, both established in the Rhine Valley. Several other optics manufacturers were later also launched in the region, including Leica Geosystems, FISBA, SwissOptic, Vectronix (later acquired by Safran), Zünd Precision Optics and Mikrop, thereby giving rise to a broad, diversified cluster. Technical high schools and R&D centers like Rhysearch and CSEM contributed to technology transfer and to the success of the cluster.

The photonics and optical engineering companies in Switzerland collaborated in terms of sharing market data, industry information and ideas. The players in the industry established a study program in optics and photonics and were connected through a photonics department at SWISSMEM, the Swiss Association of Mechanical and Electrical Engineering Industries. Additional synergies were generated by rotating apprenticeship programs affording apprentices the opportunity to work for different photonics companies.⁴¹

Most of the companies interviewed were not part of a closely organized cluster along the lines of this optical cluster. However, some companies were part of a long industrial tradition in given industry sectors and thus benefited indirectly from the presence of other firms. These informal clusters benefited the companies in different ways.

⁴⁰Porter, ME (1998) Clusters and the new economics of competition. Harvard Business Review 76 (6): 77 and Porter, ME (1990) The competitive advantage of nations. The Free Press, New York.

⁴¹Adapted from FISBA company profile.

A textile industry cluster would include **Lantal** and **Sefar**, two companies in this sample, together with many other firms and machinery producers with a long tradition in Eastern Switzerland. The decline of the textile industry also made underutilized properties available for new companies, such as **Filtrox**.

- Indirectly, **Felchlin** benefited from a long tradition for chocolate production in Switzerland.
- A Swiss coffee machine cluster included both **Thermoplan** and **Jura**, in addition to other Swiss producers not covered by this research, such as Franke, Schaerer, and Frismag/Eugster.
- Part of a large cluster of automotive component suppliers included **Oetiker**, **Komax**, and **u-blox**.
- A strong and traditional railways and transport cluster included **EAO**, **Sécheron**, **LEM**, and **Plumettaz**.
- Part of a large Swiss life sciences cluster was **Bachem** and **Geistlich**. A Medtech cluster included **Medartis** and **C+M**.
- The microelectronic cluster included **Rüeger** and **Sylvac**.
- A chemtech cluster included **Burckhardt Compression**.

In some cases, firms also profited from the presence of companies from completely different industries, located nearby, which have also been covered in this analysis (see the example of Lantal working together with maxon).

Although this research excluded companies from the watch industry, it could document connections and the origins of a number of firms which greatly benefited from the presence of the large watch industry cluster, such as **LNS**, **DC Swiss**, **Sylvac**, **C+M**, and **Acutronic**.

Equally, many companies in the research sample leveraged an extensive presence of skilled parts manufacturers in the plastic or metal industries providing precision components, such as for **EAO**, **Thermoplan**, or **Jura**.

Swiss Framework Conditions

Swiss SMEs, operating from what is certainly one of the highest cost countries in the world, have learned to leverage the best of what is available from the local business environment. High cost is turned around into a premium strategy. A highly skilled labor force pool, combined with the dominant dual educational system, is leveraged to provide the human resources needed to run a premium market strategy. The presence of various industry clusters found for almost every conceivable industry sector creates an advantage in terms of gleaning additional benefits to strengthen a firms' competitiveness. And, last but not least, the image of Switzerland is leveraged to support the high-quality image of their products.

For Swiss SMEs, utilizing all of these framework conditions provides a substantial boost to a firm's competitiveness in global export markets. The benefit of these

conditions does not accrue automatically, and the Swiss SMEs have become experts in the *leveraging* game.

Open Access This chapter is licensed under the terms of the Creative Commons Attribution 4.0 International License (<http://creativecommons.org/licenses/by/4.0/>), which permits use, sharing, adaptation, distribution and reproduction in any medium or format, as long as you give appropriate credit to the original author(s) and the source, provide a link to the Creative Commons license and indicate if changes were made.

The images or other third party material in this chapter are included in the chapter's Creative Commons license, unless indicated otherwise in a credit line to the material. If material is not included in the chapter's Creative Commons license and your intended use is not permitted by statutory regulation or exceeds the permitted use, you will need to obtain permission directly from the copyright holder.





Different Strategies for Growth

Specific managerial practices adopted by the SMEs have been detailed in previous chapters. This chapter takes a step back and reviews the growth trajectories of the documented firms over their histories. Plotting growth (expressed in sales) over time (expressed in years) resulted in a scatter diagram that demonstrates substantial differences across the 36 sample firms. If these firms followed the managerial practices described earlier, what then accounted for the substantial differences in size and the speed of growth over the life of the companies? Were there any differences in growth that could be traced to different combinations of the chosen practices?

Differentiation Through Expansion Strategies

Several types of strategic classification have been used by business strategists in the past. One of the most often used categorizations was put forward more than 60 years ago by Igor Ansoff.¹ Ansoff's model had companies start from a given combination of technology and products, as well as from a given market, adopting either a strategy of *market penetration* or, alternatively, moving into new markets with existing technology (*market development*) or, alternatively, taking new technologies or products but remaining in their existing markets (*product development*). If a company chose to combine both new markets and new technologies, it was said to pursue a strategy of *diversification*.

Although developed to guide diversification strategies, the same model can be employed to track general expansion strategies over time. As can be demonstrated, the firms in this sample did not, as a rule, pursue diversification but instead followed

¹Ansoff, I (1957) Strategies for diversification. Harvard Business Review 35/5: 113–124.

the path of pursuing adjacent opportunities, either in terms of *market development* or *product development*. Once a new adjacent market niche was found, companies continued to grow the newly found niche by making it, over time, their existing market by pursuing a *market penetration strategy*, often leaving behind their initial position held during earlier times.

Typical *classic market penetration* strategies were followed, among others, by a number of firms.

- **Caran d’Ache** took a number of different writing instruments and technologies into the same markets.
- **Medartis** expanded into new Orthopedic applications based upon the same medical or production technology.
- **Ricola** stayed in the same field but continued to introduce different product versions.
- **maxon**, once finding its niche in small electric motors, continued to add new versions and improved technology into different markets.
- **Bachem** increasingly added new products and services aimed at the same markets.
- **FISBA** continued to innovate in the same optic technology space.

Several companies moved into new markets with their existing technologies, practicing *product development*. The following companies exemplify this.

- **Plumettaz**, taking its winding technology into Telecom markets.
- **Thermoplan**, introduced its cream and milk whipping technology into the commercial espresso market.
- **Selectron**, extending its electronic controls toward in-train controls.
- **Oetiker**, expanding its connector technology into new applications and markets.
- **Jura**, taking its small appliance know-how to in-home espresso machines, which became its major market.

Other companies, once venturing beyond their original core into adjacent fields, experienced a stretch of resources in order to expand along multiple tracks. Those companies often divested some business lines, retrenching to a single line of focus, as was discussed in more detail in Chapter 8/Part IV.

- **Filtrox**, divesting its equipment and systems business to refocus on filters.
- **LEM**, divesting its equipment and measurement business to refocus on components.
- **Bachem**, concentrating on the synthetic peptide area by stepping out of biologically based product lines.

Yet again, reviewing the different versions of market expansion, market penetration, product development, or market development and scattering them out among the 36 companies, no significant differences in growth over time and even longevity

of firms can be explained, based on these strategy differences. Therefore, other factors still had to account for the differences in growth.

Global Expansion Strategies

Are these companies, some as small as CHF 25 million in sales, global companies? Are some of the larger, faster-growing firms more *global* than the smaller ones, growing much more slowly?

In the interviews, the description *global* was rarely mentioned. As a general rule, the SMEs did not see themselves as *global* in the traditional sense of the word. Given their moderate size, and their role as exporters, these companies were internationally active, covering many markets, from their home base. The pursuit of global markets was a must for all of them, however, because the domestic market in Switzerland simply did not provide enough opportunity to fund a competitive firm.

Not all global strategies are the same. Global companies are said to follow either a *market global* or an *asset global* strategy.² Companies pursuing a strategy to extend sales across multiple geographic markets are described as adopting a *market global* pathway. Clearly, the researched firms, by the nature of their sales and distribution networks, fit this description. Market global does not require entry into all existing geographic territories, of which there are now more than 200. Instead, market global entails that the majority of the relevant geographic markets for the chosen industry or segment are covered.

A review of the sales and distribution strategies of the smaller researched firms indicates that even those companies maintained distribution, albeit through independent distributors, to as many as 50 or more markets, whereas the larger companies tended to maintain fully owned sales and distribution subsidiaries in their key markets.

- **DC Swiss** relied on about 30 exclusive distribution and technology partnerships to reach into some 50 international markets.
- **Sylvac** relied on an extensive global network of independent agents covering most markets with substantial manufacturing industry clusters.
- **Jura**, about ten times the size of DC Swiss or Sylvac, marketed espresso machines globally through sales subsidiaries in key markets and through national dealerships in other countries.

This experience demonstrates that smaller firms relied mostly on independent dealers or distributors, whereas larger companies had sufficient resources to build international subsidiary networks, exerting greater control over sales.

²Jeannet JP, Hennessey DH (2004) *Global Marketing Strategies* (6th edn.). Houghton Mifflin, Boston/New York, p. 259–260.

Larger firms followed an *asset global* pathway, building production and service assets in key locations to supplement their Swiss base. These companies combined a market global with an asset global pathway to become full-fledged global companies on a relatively small scale—in the range of CHF 200 to CHF 500 million—compared to firms typically viewed as global by international standards, usually accounting for sales in the billions.

- **Komax** maintained more than a dozen production sites in different countries.
- **Oetiker** maintained 12 production operations in different countries, accounting for most of its connector output.
- **maxon**, while marketing to 40 countries, maintained production centers in Germany, Hungary, and Korea.
- **Burckhardt Compression** expanded production to India, USA, and China.
- **Sécheron** maintained major production sites in the Czech Republic, China, and Italy.
- **LEM** operated most of its component operations in China and Bulgaria.

It is interesting to note that these firms exhibited above-average growth and reached higher sales volumes compared to many of the smaller firms. This suggests that the global asset strategy described is closely linked to long-term growth. As shall be pointed out later in this chapter, the ability to field such an extensive global manufacturing footprint is also closely linked to the adoption of other practices in the area of governance, management, and financing, as described, and a willingness to engage in mergers and acquisitions (M&A), as will be addressed later in this chapter.

What were the underlying forces for these SMEs to adopt such a global posture? A major reason driving them into global markets was, and continues to be, the small domestic market. None of the firms in this research would have been able to prosper to the extent they did if they had restricted themselves to the Swiss market only. Export quotas for most of the firms ranged around 80 percent or more. Although this project was focused on exporting firms, it became clear that none of these firms could exist, or prosper, based on just the local market. Prevailing economies of scale in their chosen sectors demanded a market beyond the home market.

Another important aspect is the reason for the SMEs' global success. These companies selected markets and segments governed by a considerable *global logic*.³ Particularly in B2B markets, industry requirements turning increasingly around the same issues meant that Swiss SMEs could market solutions and products with global appeal. Under those circumstances, moving into multiple markets added to the base volume and rewarded companies that moved into key markets on a global scale.

The globalization of markets, combined with increased market openings and access to more countries for trade, contributed significantly to making these global strategies successful. World trade saw a continued expansion over decades, trade

³Jeannet JP (2000) *Managing with a global mindset*. Financial Times/Prentice Hall, London.

barriers were lowered, customs abolished for large regions, such as the EU, and nontrade tariffs were reduced, all contributing to an open market of which these SMEs took advantage. They still had to adopt the practices described in earlier chapters to create superior products, but the economic environment was theirs to exploit.

Reflecting on the most recent developments around the global trade environment, the status of globalization has come under attack from many directions. SMEs grown successful under open world market conditions will need to defend their business in the future under more hostile circumstances. This does not mean that globalization or global strategies are practices of the past. The opportunities of SMEs will remain driven by the global logic of its customer base, requiring the same or similar product solutions based on similar technologies. However, a new approach to harvest those globalized opportunities may be demanded, the outlines of which are slow to emerge.

The Role of M&A in Growing SMEs

The number of SMEs in the sample engaging in M&A activities was relatively small. What does not count here is market expansion, or takeover, of independent distributors, which turns firms into fully owned sales subsidiaries. This process was covered in Chapter 12 on sales and distribution. Highlighted here are the acquisitions of existing players, or businesses, to expand the overall operation and to add either new product lines or strengthen existing ones.

Sefar, the oldest company, was the product of a *great merger* among several companies in the same business.

- To create **Sefar**, six firms merged in 1907 to form a single company with two separate business units—Schweiz. Seidengazefabrik AG in Thal (SST) and Schweiz. Seidengazefabrik AG in Zürich (SSZ). Five years later, Züricher Beuteltuchfabrik (ZBF) joined the union. The union dominated the world market for silk bolting cloth. Although established as a single legal entity, SSZ, SST, and ZBF operated independently in the market, presenting themselves independently to take advantage of their respective brands, until merging finally in 1995 by creating Sefar (derived from Seiden-Fabrikanten Réunion, i.e., united silk manufacturers) as a registered limited company.⁴

No other such large merger was recorded for any of the other researched firms. Four companies in particular used the acquisition path successfully by adding additional businesses to their lines: **Oetiker Group**, **Komax**, **Burckhardt Compression**, and **Datamars**.

⁴Adapted from Sefar company profile.

Oetiker, producer of clamps needed by automotive subassemblers, used acquisitions to bring together a set of tools and equipment that could be used for the purpose of assembly of its clamps.

- **Oetiker** acquired Allert in 1997, active in fastening for the automotive sector, as well as supplying hinged steel belt conveyors. Allert continued to operate under its brand name and was kept as a separate legal entity as a fully owned subsidiary.
- Levi Peterson, a Swedish company active globally in engineered fastening devices specializing in commercial vehicles, was acquired in 2014 and operated as Oetiker Sweden AB, combining sales and production on the same site.
- In 2014, Oetiker acquired Rostra Tool Company, based in Connecticut, USA. Rostra, with a 150-year history, marketed its flagship brand “Sargent Quality Tools,” hand tools for crimping, pressing, cutting, and stripping, to wholesale distributors and other industrial users. For Oetiker, the hand tool lines added to Oetiker’s system approach serving clients not only with connecting solutions but also provided required installation tools. The company was now operating as Oetiker Tools keeping the Sargent brand name for some products.
- More recently, Oetiker acquired Jiffy-tite in 2016, a leading manufacturer of engineered fluid connection parts, allowing Oetiker to obtain a stronger foothold in the quick connect market segment.

Oetiker maintained reserves for acquisitions and sometimes availed itself of bridge financing. The ability to approach an acquisition target without having to take out credit for the deal added to the credibility as an acquirer.⁵

The **Komax** strategy to pursue focus in wire processing, for automotive applications in particular, was underpinned by a series of acquisitions that brought in adjacent technologies to enlarge the role Komax played in the automation of wire processing and to integrate these additional steps into an expanded systems offering.⁶

- Starting out with a minority stake in 2011, leading to full ownership in 2015, **Komax** acquired SLE Quality Engineering GmbH, with a staff of 70. The German company was a leading supplier of quality control systems for plug-in contact connections and wire harness production, fitting easily into the Komax business.
- Next was the acquisition of TSK, a German company with deep experience in quality assurance in wire assembly. TSK developed and sold testing systems and adaptation units for testing wire harnesses and other electrical/electronic assemblies, as well as components.
- Komax stepped into taping technology in 2016 by acquiring Ondal Tape Processing and Kabatec, the global market leader in the field of taping technology

⁵Adapted from Oetiker Group profile.

⁶Adapted from Komax company profile.

systems. Serving primarily the automotive industry, the companies produced both standard and customized equipment and had been collaborating with Komax for several years prior to the acquisition.

- The most recent step into new applications for wire processing was the acquisition of Laselec, a Toulouse, France-based company with a staff of 60 and a subsidiary in the USA. Laselec was a producer of both serial and customized production equipment with a strong business in the aerospace industry. Laselec technology was increasingly applied in the automotive sector also, and through this company Komax expected better access to the aerospace industry, a heavy user of cable and wiring.
- However, when Komax went through an expansionary period in the early 2000s, entering the medical and photovoltaic sectors through a number of acquisitions targeting for new opportunities in the assembly sectors, these forays were disbanded in the process of a reorganization after the impact of the financial crisis of 2008–2009.

All Komax acquisitions were fully integrated into Komax and represented an expansion of the product and service offering aimed at the same customer groups and business.

Other companies using acquisitions to the same customer group, in order to round out their product lines, or enlarge the business, included the following:

- **Burckhardt Compression** with acquisitions in China and the USA.
- **Sécheron** with the add-on businesses of Saia and Pixy.
- **LNS** with acquisitions in the USA and Asia bringing in additional peripheral products to its core bar feeder business.
- **Datamars** using acquisitions to expand into the farm animal sector with Runitag of Spain, Temple Tag in the USA and Zee Tag in New Zealand.
- **Bachem** expanded its business by acquiring related companies with similar product lines through three companies in California (Bachem Inc., Peninsula Laboratories, American Peptide) with related businesses in the UK and a production operation in Switzerland, as well as the Clinalfa brand from a German company.
- **Filtrox** grew its international business by acquiring several smaller competitors, in the UK, Czech Republic, and Mexico, acquisitions which eventually made Filtrox the number two globally.

These acquisitions succeeded, because they were conducted in the same business, or industry focus, and were integrated into the existing sales channels. For all of these companies, the acquisitions provided significant growth to their business and were made possible through sufficient internal financial resources or access to external investment funds.

Not all acquisitions contracted by the researched firms turned out to be successful. Some, even when in related businesses, did not reach expectations and were later reversed through divestments.

- **LEM** expanded beyond its original component transducer business into testing equipment in 1987. An acquisition in the UK in 1989 provided the entry into the instrument market, followed by a takeover of the leading US competitor in 1992, a Swiss supplier in 1993 and an Austrian instruments company in 1995. During this time, profitability of the instruments segment exceeded that of the component business, leading to a forced expansion into the equipment direction.
- With LEM component business picking up substantially as more and more applications were developed, the instruments and equipment business became a drag on LEM results. LEM entered a period of divestment and retrenchment, returning to its core component business. The high current system business was divested through an MBO in 2003.⁷

Some companies, such as **u-blox**, have found success with acquiring just elements of operations from other companies, or, as in the case of **Bachem**, by using only some elements even when acquiring an entire business.

- **u-blox** operates 15 research and development centers across the world today. Its acquisition strategy was closely linked to the need to gear up development capacity. Starting early in its development, the company concentrated on acquiring engineering teams abroad, avoiding operating businesses and leaving them in their original location.⁸

Although most smaller companies did not engage in acquisitions for expansions, those who did encountered greater challenges than the larger SMEs.

- **Kuhn Rikon** acquired a 60 percent stake in the company Spring in 1988 giving it an entry into the table-cooking segment and using the company's production capacity. Given a lack of full control, Kuhn Rikon could not impose its ideas when conflicts arose with the minority owners and was eventually forced to sell the stake in the midst of a financing squeeze due to production expansion. In 1999, Kuhn Rikon unsuccessfully sought to acquire Sigg, maker of aluminum drink bottles, ending up with buying some equipment, staff, and brand access. Again, conflicts arose and the Sigg brand had to be relinquished.⁹
- **Fraisa**, in the midst of a major capital investment in production machinery, acquired Schäublin (ESO) for access to threading tools and gauges. The acquired business was unprofitable, forcing Fraisa to compensate losses through bank loans. After full integration of the operation, the site was later closed as part of a restructuring effort.¹⁰

⁷Adapted from LEM company profile.

⁸Adapted from u-blox company profile.

⁹Adapted from Kuhn Rikon company profile.

¹⁰Adapted from Fraisa company profile.

- **C+M** had made many acquisitions over its history. Over the past 20 years, the company acquired two companies with production sites in La-Chaux-de-Fonds, a dental business, a watch movement company, and a watch case maker, all in the same region. Not all the acquired companies could be kept, and some had to be divested when they did not fit adequately into C+M's global strategy.¹¹

In general, companies who made successful acquisitions to their business, and integrated them well, achieved higher growth rates than those companies which did not. As will be pointed out later, a close connection exists with the resourcing of a company that takes advantage of such acquisition opportunities.

Decoding Drivers for Growth by Company Size and Age

Although information concerning sales, age, and employment was collected on each company, it was never the intent to rank any of the companies by an objective standard, such as size alone. If there was one criterion of interest, it was longevity and uncovering the patterns that led to extended company life. An examination of the chart for growth patterns and firm positions by sales and age yielded two main observations: First, firms either developed primarily in terms of sales growth, even at a relatively young age; or, second, alternatively, they maintained a steady pace over decades while maintaining a moderate size. A few combined both volume growth and steady pace over time.

What then accounted for such differences among these companies? What were the main drivers for sales or volume growth? What was driving the measured pace of smaller firms over long periods of time? What made all of these firms survive over generations?

Two general drivers emerged. First, driving longevity over generations of owners and managers required companies to adhere to the practices described in the earlier chapters, ranging from focus choices, segment choices, smart production footprints, engineering solutions for products, innovation strategies, and, finally, leveraging all the advantages of having a Swiss base. Following those principles ensured relevance in the market and sufficient success in propelling the enterprise forward over many years. It was found that all of the investigated companies had managed to do so, albeit, at times, in different ways.

On the second dimension—sales—another pattern emerged. A noticeable difference in some adopted practices could be discerned for companies above versus those below the CHF 120 million sales limit. The observed differences had to do with the adopted governance, including ownership, management, and financing, as well as the pursued global asset strategy described earlier. However, there turned up another noticeable difference among the firms having reached sales of about CHF 120 million

¹¹ Adapted from C+M company profile.

or more, in as much as some of these companies reached significant scale much earlier than others.

Examining Differences in Growth Patterns

In previous chapters, the outlined management practices provided detailed insights into the kind of decisions that have been made, over time, at the researched firms. In order to detect patterns, practices were bundled with others that were similar; then, each of those was aligned with an individual chapter. The bundles ranged from ownership to governance and market focus, as well as across functional practices, such as marketing, finance, innovation, and production. Since all of the researched firms can be considered successful over an extended period of time, practices were not evaluated in terms of their relative effectiveness nor was their relative effectiveness compared to one another. Coming to the end of this detailed analysis, it is time to see if an assessment is possible that aids in determining which bundles of practices, or combinations thereof, account for most of the differences in growth performance.

A number of questions were posed in this inquiry. In the absence of hard statistics, something deliberately avoided by the authors, pattern analysis was employed to find answers that would help shed some light on the different growth paths observed among the interviewed firms.

To compare different growth patterns, **Graphic 23.1** was created, which distributes the companies according to their age in relation to their last known (sometimes only estimated) sales. In this chart, the firms range from about 20 to more than 175 years of age, with those founded more recently shown on the left of the chart and the oldest clustered on the right. At first glance, one can spot the youngest firm (**Wyon**, 1999) in the bottom left corner and the oldest (**Sefar**, 1833) in the upper right quadrant. Superficially, this might suggest the conclusion that as firms grow older, their size increase—not an earth-shattering conclusion onto itself! Yet, simply looking at years of operation would not lead to significant insights. When viewed from the perspective of sales, or size—in this case taking all the firms above CHF 120 million in sales into consideration—the chart demonstrates that this segment includes companies of varying ages, ranging from **u-blox** (1997) to **Sefar** (1833); this indicates that among the larger firms there were both those which had been founded recently and some that have been operating for a long time.

Equally, clustering companies that had sales below CHF 120 million included among the more recently founded firms **Medartis** (1997) and **Wyon** (1999), as well as long-running companies, such as **Kuhn Rikon** (1925) or **Lantal** (1886). Again, simply relying on years of operation would not lead to sufficiently deep insights regarding the reasons for the varied growth patterns.

Even more telling were vertical patterns, clustering the companies by age, as expressed in decades. The 20-year vertical included firms as small as **Wyon**, with estimated sales of less than 20 million, as well as **u-blox** with sales of more than CHF 400 million. The same distribution from small (less than CHF 30 million) to very

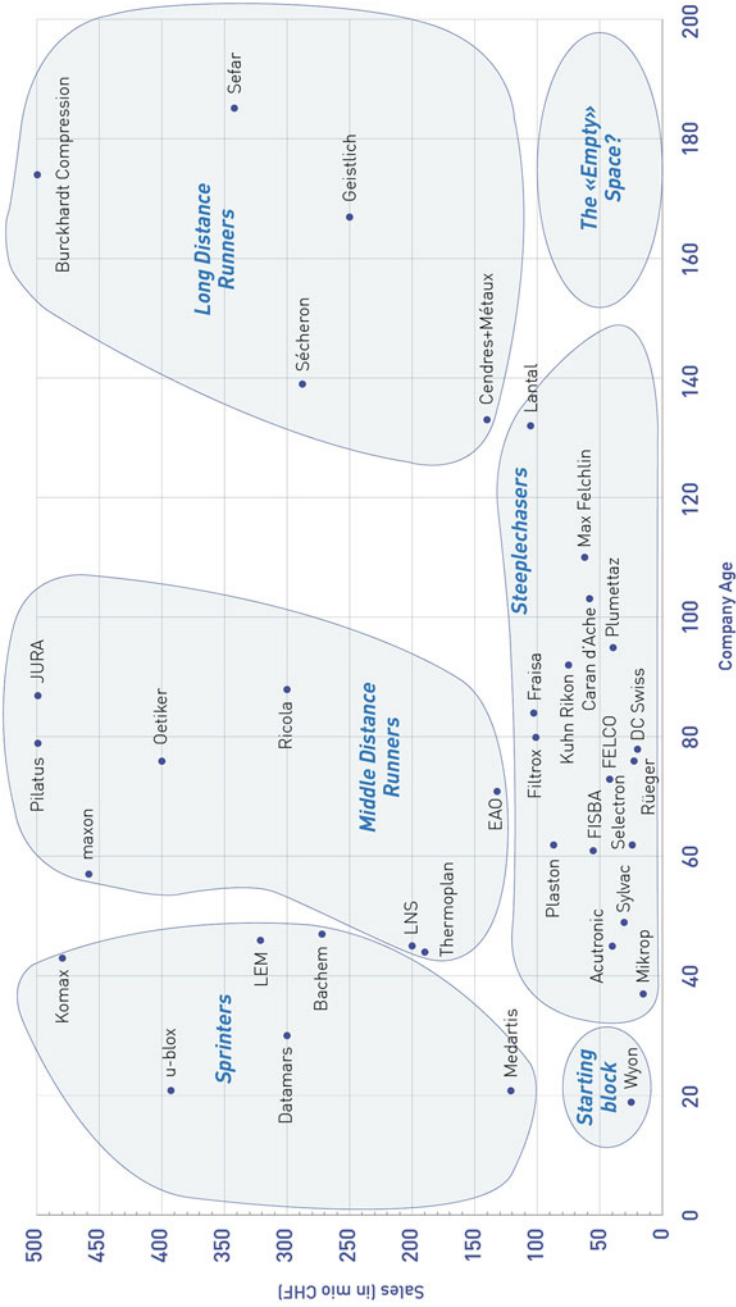

Graphic 23.1 Source: Graphic compiled by authors

large (above CHF 300 million) was noticeable in a number of successive age decades, suggesting that firms of similar ages still displayed considerable variations in growth patterns.

Some readers might now argue that the differences lie in the nature of the industries. If we scan the companies with sales above CHF 200 million, we can see those with *big-ticket items*, such as **Pilatus**, maker of private planes, and **Burckhardt Compression**, maker of industrial compressors. Also, within the same size category, there are a number of industrial component producers, such as **u-blox** and **Oetiker**, selling low-ticket components, but selling large quantities of them. While the majority of larger companies operated in the B2B space, they were joined by **Ricola** (herbal candies) and **Jura** (espresso machines) targeted in the B2C space.

Since grouping companies either by age, start year, and size or by industry served did not yield consistent answers to our fundamental question about differences in growth patterns, it was concluded that insights had to come from a further analysis of strategies pursued, as well as how intensively companies adhered to those practices examined and explained in previous chapters.

Clustering Companies by Development Trajectories¹²

An examination of different growth trajectories by visually grouping the companies regardless of industry and by combining them on the basis of the similarity of growth trajectories, or end destinations, yielded a number of clusters.

Six different clusters could be identified this way, based upon similarity of position on the master chart, representing different growth experiences over time. All but one of the firms were grouped into four main clusters. Two other, small clusters accounted for special circumstances. See Graphic 23.1.

Rather than simply numbering clusters one through six, illustrative labels were applied borrowed from Olympic track and field running disciplines. Olympic athletes competing in different disciplines, each of a different length, pace, or speed, are able to earn medals in any of them. This fact was attractive as an image when considering the companies covered in this research. All companies stood the test of time and survived competitive forces, and all became medalists, if not gold medal winners. But they reached that result in many different ways, choosing to compete in different disciplines.

¹²In Graphic 23.1, the sales scale was capped at CHF 500 mio, allowing for an expanded view of the smaller firms up to CHF 200 mio in sales. Three firms were impacted by this (Pilatus, Jura, and Burckhardt Compression). Of those, Pilatus had grown to about CHF 1 billion, and the others were slightly above the CHF 500 mio mark. Although all three firms had surpassed the originally intended cutoff of CHF 500 mio, they all spent most of their history as SMEs below that limit. Their experience and practice of how to pass the CHF 500 mio limit appeared important to the authors: company age per 2018, and sales recorded for 2017, 2018, or 2019, according to data availability.

Meeting the *Long-Distance* Runners

The first cluster was labeled *Long-Distance* Runners after the Olympic 10,000 m discipline, having covered the longest distance and with a higher average age than the other SMEs researched. Located in the upper right corner of our chart, this cluster is made up by five firms (**Sefar**, **Burckhardt Compression**, **Geistlich**, **Sécheron Groupe**, and **C+M**), all representing very different industries and yet displaying the characteristics of longevity, or stamina, combined with the significant sales growth. Averaging about 170 years of existence, these companies combined a stable governance structure with all the hallmarks of management practices, such as focus, segmentation and superior engineering and innovation.

Governance was opened up by either separating ownership from professional company management (**Geistlich**, **Sefar**, **C+M**), turning into a public company (**Burckhardt**), or by installing a stable group of owners/managers (**Sécheron**), providing stability and allowing professional management to operate with relative independence. All but one of these companies also pursued an *asset global* strategy, building production assets in other parts of the world while still maintaining significant production in Switzerland. Whether public or privately held, these firms obtained access to sufficient resources to expand globally and, if needed, to make acquisitions for expansion.

Meeting the *Middle-Distance* Runners

In Olympic terms, *Middle-Distance* Runners are the athletes that compete in the 1500 m and 3000 m disciplines. These athletes combine speed with stamina for distance. The eight companies in this cluster (see **Graphic 23.1**) fit this description. On average, they had been in existence for about 80 years, and they have been growing to a similar size as the *Long-Distance* runners, but they achieved it in only half the time.

Their strategy was also characterized in terms of openness in governance, by either including independent board members (**Oetiker**, **Ricola**, **Jura**, **EAO**) or by relying on professional management (**maxon**, **LNS**, **Pilatus**), the latter one having achieved the largest sales volume of any firm included in this project. Importantly, none of these companies have gone public. Their solid financial performance assured them independence and considerable freedom to operate. Like many *Middle-Distance* Runners, they were on track to achieve longer distances over time. Some of these companies (**maxon**, **Oetiker**, **LNS**) built significant production assets abroad following an *asset global* strategy. Other firms were able to focus their business system on a reduced number of functional activities (**Jura**, **Thermoplan**), freeing capital for a *market global* strategy. In general, all of these companies adopted an intensive global strategy fuelling their growth. Their private and stable ownership allowed these firms to pursue long-term strategies and remain independent.

Meeting the *Sprinters*

The third cluster was named *Sprinters*, known for speed and dominating the Olympic distances of 100 m or 200 m. Sprinters display an explosive start out of the block, combined with acceleration down the stretch. Our cluster contains six firms (**Medartis**, **u-blox**, **Datamars**, **Bachem**, **LEM**, and **Komax**) that fit this characterization.

Although all of these firms have become public companies, they did so in different ways. **u-blox** began with external financial investors who then brought the company on the stock market, thus tapping considerable resources for growth. **Komax**, **Bachem**, and **LEM** undertook an IPO after several years of successful operation under their founders. **Medartis** waited longer for its IPO. All applied the practices of focus and product platforming. In terms of ownership structure, at **u-blox**, **Komax**, and **LEM**, founders no longer played a controlling role. **Datamars**, created as a joint venture between two firms, quickly became influenced by private equity owners who came to support an aggressive acquisition strategy that drove growth.

Meeting the *Steeplechasers*

For the fourth cluster, the image of the special 3000 m *Steeple* race, combining overcoming of hurdles with endurance, seemed appropriate. This cluster is made up of 16 firms in the CHF 20 million to CHF 100 million sales range and in existence for an average of 80 years. Clearly, these firms have existed for several generations, while experiencing slower growth than the other clusters. Typically, they are in sectors experiencing less underlying growth than other clusters. Included in this cluster are **Mikrop**, **Acutronic**, **Sylvac**, **FISBA**, **Plaston**, **Filtrox**, **Fraisa**, **Caran d'Ache**, **Max Felchlin**, **Plumettaz**, **DC Swiss**, **Rüeger**, **Selectron**, **Kuhn Rikon**, and **Lantal Textiles**.

Steeplechaser companies shared a strong preference for independence and often avoided public ownership at all costs as they saw this as a disadvantage. In line with their more limited financial resources, these firms pursued a *market global* strategy, investing in sales and distribution through distributors. Some companies did operate assets abroad, although they tended to be fewer and smaller than those in other clusters. M&A transactions were infrequent.

Ownership was mostly restricted to founders or founding families or their successors. Three companies had changed hands to new family ownership (**Fraisa**, **Acutronic**, **Lantal**). One company was owned by a foundation (**Felchlin**), and two had recently been acquired by corporate owners (**Selectron**, **Rüeger**), while continuing to operate as independent entities. To make it over the long-term, these companies usually combined ownership and management into a single role. They planned to continue in that mode as long as they could bring in management that is technically sophisticated in their core business.

The existence of a fifth cluster, which is labeled *empty cluster*, where long-lasting businesses below the line of CHF 120 million could be expected, suggests the difficulty of going the distance as a smaller company. The fact that several of the small companies in the cluster of *Steeplechasers* have slipped under different forms of corporate ownership umbrellas appears to confirm this.

Who is in the *Starting Blocks*?

The sixth cluster, *Starting Blocks*, is populated by a single firm (**Wyon**), the youngest company included in this project. Having passed the initial phase and entering a potential period of growth, it was not clear yet if this company will turn into a *Sprinter* or join the group of *Steeplechasers*. Judging from the experience of firms across the various clusters, *Steeplechasers* largely did it on their own power, such as through bootstrapping, whereas *Sprinters* typically opened themselves up in terms of governance, resources, and management.

The large number of start-ups emerging in Switzerland would, in the authors' view, populate the *Starting Block* position. The analysis presented in this book should demonstrate the options available by having outlined the long-term implications in terms of control, ownership, and freedom of operation to play a true SME game.

Size vs. Longevity

The companies included in this research have shown that they progressed along the two vectors of *Size* (measured in sales in CHF) versus *Longevity* (age of company, measured in years).

The main drivers for *Longevity* were more strongly correlated with the practices of focus, segmentation, and innovation, particularly when companies restricted themselves to a narrower range of activities to achieve the necessary scale through specialization. These practices were described in detail in Chapters 3 and 21. Both larger and smaller firms engaged in practices that enhanced their competitiveness, as described in Parts V and VI, thus achieving *uniqueness*. Smaller firms again were more reliant on the *leveraging* practices around *Swissness*, as described in Chapter 22.

The main drivers for *Size* were closely related to practices related to Governance Practices covered in Parts II and III. In particular, ownership structures and stability, as well as financing, provided the basis for the resources that companies could tap to fuel expansion. For the clusters of *Long-Distance* and *Middle-Distance* Runners and above all the cluster of *Sprinters*, access to external resources allowed the firms to engage in acquisitions, often bolting on existing businesses, expanding their production footprint and allowing them to practice a *global asset* strategy, all eventually leading to superior growth compared to the cluster labeled *Steeplechasers*. This

practice was more pronounced for the *Sprinters* than for either *Middle-Distance* or *Long-Distance* Runners.

The firms that *progressed diagonally*, combining both sets of practices into managing for *Size* and *Longevity*, clustered among *Long-Distance* Runners, achieved longevity by being just as efficient in focus and segmentation as other companies and doing just as well in innovation and product building as the rest. In addition, however, they managed ownership stability issues exceptionally well by consolidating ownership into a loyal and committed group of stakeholders while tapping outside financial resources.

The cluster of *Steeplechasers* was further differentiated from the companies above CHF 120 million in sales from the *Sprinters*, *Middle-Distance* and *Long-Distance* Runners through a different perspective on control. *Steeplechasers* were attached to ownership control to assure them operating freedom over their business. Firms belonging to other clusters, but particularly the *Sprinters*, traded off ownership control for access to additional resources combined with continued operating freedom, to engage fully and freely in the practices described earlier. *Sprinter* companies, although having largely moved from private to public ownership, had a much more positive view of their ability to maintain operating and strategic freedom of their business while under full or partial public ownership.

Surviving Crises

It would be incorrect to assume that growth of the SMEs in this study followed along a straight line. As the company profiles in the back of the book reveal, many companies had to overcome substantial adverse developments. Many of them had to conquer multiple crises. Others made courageous bets on future developments, at times even risking their business altogether. Still others fell into steep declines and had to be rescued by new owners or management.

Given that all companies were founded prior to 1999, all had to survive three recent major crises, the most recent one in the form of the global COVID-19 pandemic still ongoing as this book went to print.

- The *Financial Crisis 2008* had a direct impact on a number of firms, such as **Lantal Textiles** through the decline in its major market for aircraft interiors, or for many smaller firms through difficulty in obtaining bank lending, with others rethinking their business strategy. Detailed stories on how this was managed can be found in the profiles of **Fraisa**, **Rüeger**, **DC Swiss**, **Thermoplan**, or **Komax**.
- The decision of the Swiss National Bank to stop supporting the currency relationship of the *Swiss Franc* versus *Euro* in early 2015 resulted in an immediate price increase of about 10 percent for Swiss exporters. Some companies had to find ways to deal with this, such as through different sourcing strategies or asking for support from their staff. These efforts are described in some profiles, for example, for **Felco**, **LEM**, or **Sécheron**.

- Finally, as this book went to print, all companies found themselves in the midst of the economic impact due to the global *COVID-19 Pandemic* that began in early 2020. Since the company profiles and documentation were concluded by the end of 2019, the decision was taken not to reinterview all firms on how they were dealing with the impact of the pandemic. Past history would suggest, however, that these companies having stood the test of time will, by and large, also master this crisis, although the lasting impact might well leave bigger scars in their industrial fabric than the previous two crises of 2008 and 2015.

Although the most recent crises are more likely to be remembered by our readers, there were major wars that shaped the economic environment in some very restrictive ways and were often of longer duration than the more recent crises, however impactful they might have been.

- World War I (1914–1918) was experienced by eight of the firms, all founded still in the nineteenth Century, resulting in loss of market access or difficulty in sourcing materials for production. The profiles of **Felchlin** and **Caran d’Ache** touch on the impact on those companies.
- The Great Depression of the 1930s was experienced by 14 of the firms, at times requiring adaptations due to loss of customers (**Plumettaz**). Despite the difficult economic circumstances at that time, three companies were founded (**Ricola**, **Jura**, **Fraisa**), thriving and growing to this day.
- The period of World War II (1939–1945) was particularly difficult for any export-oriented firm because all borders around Switzerland closed, export markets were lost, and companies had to retrench to the Swiss market. The market closure gave the impetus for founding **Pilatus** and **Filtrox**, and three more entrepreneurs saw an opportunity to open up during the war (**DC Swiss**, **Oetiker**, **Rüeger**).
- The post-World War II period was a time of rapid and sustained economic growth that benefited the exporting SMEs in particular. Several firms were founded during this period, a boom ending with the *Oil Crisis 1973*. By the end of this period, all but five of the 36 companies were operating.

Reflecting on the experience of these firms over decades indicates that they were not simply *one-hit wonders* or *flash-in-the-pans* but represented sustained practices over time. It can therefore be claimed that the practices described in this book have stood the test of time. Of course, it is also true that many firms were not able to make it through such upheavals, but the focus here is on the *survivors*.

Courageous Bets for Growth

A number of our companies wagered significant bets on new markets, technologies, or processes that had to be considered daring in relation to the size of the companies. These are not the initial investments, or risks, assumed by the company founders, or

investments made in the course of company expansions. Instead, the bets referred to here are later investments with a substantial impact on the trajectory of a company.

The most significant was the decision by **Pilatus Aircraft** to invest a sum estimated to have been about CHF 500 million for the development of a new executive jet, PC-24, with the effect of eventually doubling the company's business. This choice, requiring investments over many years with an uncertain outcome, was certainly courageous.¹³

Other companies who entered into major investments changing the course for their business are included below.

- **Thermoplan**, investing a significant amount of the founder's savings at that time into a fully automatic coffee machine for use in hospitality.
- **Datamars**, taking up new capital to expand into the veterinary segment for its identification business.
- **Jura**, ceasing its production of household and kitchen appliances to invest in a fully automatic espresso machine for in-home use.
- **Geistlich**, leaving the old-fashioned bone processing business to invest in natural bone enhancement material for dental surgeries.
- **Lantal**, making significant investments and acquiring capacity to produce materials for passenger aircraft and ground transport interiors.
- **Selectron**, placing significant investments into the development of in-train electronic controls.
- **EAO**, stepping out of the transformer business and investing all of its resources to build the pushbutton business.

The full stories behind these investments are contained in the company profiles of each firm.

Resurrected Companies

A final mention is earned by a few companies that were saved from certain decline and resurrected by new owners or management, making the companies blossom again, often reaching new heights. In the company profiles, close attention was paid to these ups and downs, and the resurrection of two companies are detailed—these firms would almost certainly have disappeared without the intervention of new ownership.

- **Selectron**, targeted for shutdown by its owner Schneider Group, who had acquired the unwanted business in the course of a number of acquisitions, was resurrected by new management when entering the in-train electronic control

¹³For more details of this investment, see Pilatus company profile.

business and growing to five times the size over about 20 years, with a significant share in its sector.

- **Sécheron**, where the new owner–management group that assumed its assets from a financial owner, together with adept management, returned the company to its traditional position as a major player in energy management for electric-powered trains.

The research also uncovered other histories of resurrected companies in the Swiss SME space, although these firms could not be interviewed.

It is important to mention **DT Swiss** in this context, maker of bicycle spokes and wheels, resurrected out of the terminated operation of DT (Tréfilier de Bienne), an old wire and cable manufacturer formed in 1634. The company, employing almost 1000 in 1975, went into decline resulting in liquidation in 1994. Three managers, capitalizing on the company’s specialty for cold wire extrusion, spun out the core of the new business on spokes, now exceeding CHF 100 million in sales, with about 450 employees (2015) and achieving global leadership in offtrack bicycle wheels.

A second company to be mentioned here is **Dottikon Exclusive Synthesis**, a specialist in hazardous chemical reactions performed for other companies. This business, originally founded in 1913 as an explosives company, evolved over many years to become a producer of chemical intermediates. Acquired in 1987 by Ems-Chemie, the business was spun off in 2005 and went public, growing ever since into a freestanding business with sales of about CHF 175 million (2019–2020).

The inclusion of the histories of both **Dottikon** and **DT Swiss** as part of this review, in conjunction with the experience of Selectron and Sécheron, signals an important message when reviewing the trajectories of the researched SMEs: Any SME, over its lifetime, may encounter a negative patch. Given the tenacity of a new management, or new owners, a company’s fortune may be turned around, usually when it relies on the firm’s traditional strength, thus extending the life of the business. When this occurs, new management and owners depend on the same principles detailed in the analysis of this book.

SMEs, if well cared for and managed, have many lives!

Open Access This chapter is licensed under the terms of the Creative Commons Attribution 4.0 International License (<http://creativecommons.org/licenses/by/4.0/>), which permits use, sharing, adaptation, distribution and reproduction in any medium or format, as long as you give appropriate credit to the original author(s) and the source, provide a link to the Creative Commons license and indicate if changes were made.

The images or other third party material in this chapter are included in the chapter’s Creative Commons license, unless indicated otherwise in a credit line to the material. If material is not included in the chapter’s Creative Commons license and your intended use is not permitted by statutory regulation or exceeds the permitted use, you will need to obtain permission directly from the copyright holder.





Why This Chapter?

This chapter will strike the reader as being quite different than the previous chapters and analyses. This is deliberate and placed toward the end of the book in order to provide some additional perspective to the previous analysis. Describing the background of the founders and entrepreneurs behind the 36 researched companies, pulling together details about the practices that brought these companies to market leadership in their chosen segments, and putting the spotlight on the respective governance practices risked missing an important point: To what extent were these entrepreneurial practices freely chosen by individual entrepreneurs and to what extent were they influenced by the Swiss entrepreneurship ecosystem?

Since this question accompanied much of the research and was also indirectly aired in the company interviews, we felt it necessary to also highlight this issue separately. While the answer cannot possibly be completed in the space of a single chapter, the thoughts of keen observers of the Swiss way of running enterprises, and an economy as a whole, should be of interest to those close to this environment, as well as interested readers from abroad.

Sources for this chapter include a number of writings from social scientists in a variety of fields, ranging from political science and economics, to history. Most of these authors have commented specifically on which factors have influenced the Swiss economic system over time, as well as compared the Swiss situation to that in other countries. These sources contribute to a better understanding of the entrepreneurial practices researched for this book, outlining how they are rooted in the historic and social background of Switzerland and did not emerge in a vacuum. Still, the authors strongly believe that these practices might also be applicable in other countries, with some adaptations to accommodate the respective institutional and cultural contexts. This idea will be visited later in the chapter.

Why So Many SMEs in Switzerland?

In 2018, Narayama Murti, cofounder of Infosys, a leading Indian IT company, met local business representatives and government officials in Zurich where he was briefed on the large number of successful Swiss SMEs exporting all over the world.¹ During the ensuing open conversation, he asked why Switzerland was the host to so many of these firms, something that did not exist in India. A lively conversation developed around this issue and continued to linger in the minds of those present, including one of the authors, who eventually became part of the conversation surrounding this research project.

Although involved with the practices of Swiss SMEs for many years, the authors continued to question the origin of these companies and the role the Swiss ecosystem. It became part of the conversation within the research team, and therefore, the determination was made that this issue needed somehow to be addressed. Is this situation unique to Switzerland? Is this about Swiss exceptionalism? Could Switzerland serve as a role model for other countries? Is the fact that these companies continue to prosper a function of the social and legal environment, or, to what extent are the practices documented in this book simply good management, adopted independently of the environment?

Meeting the Indian entrepreneur demonstrated that a more coherent, articulated, and fact-based answer was needed. This triggered a research effort that was to lead into the fields of history, literature, and political science, while reviewing the contributions of a diverse number of thinkers, stretching over more than 200 years. Over the next few pages, the findings from this journey will be reported.

Swiss Tradition of Entrepreneurship

For many years, the Global Entrepreneurship Monitor (GEM) tracked the prevalence and intensity of entrepreneurial activity in a number of countries, publishing an annual report.² In 2019, GEM pioneered the National Entrepreneurship Context Index (NECI) to measure ease of starting and developing a business in a given country. Among the more than 50 countries ranked, Switzerland topped this list.³

Although these data are of recent origin, they nevertheless can be taken as an indication that Switzerland provided excellent framework conditions for entrepreneurship activities in the past, as well as in the current time. The entrepreneurship endeavors covered by the GEM survey went beyond the narrower focus of this

¹Narayama Murti, Cofounder Infosys, Asia Leaders Series, Zurich, November 20, 2018.

²Reynolds P, Bosma N, Autio E, Hunt S, De Bono N, Servais I, Lopez-Garcia P, Chin N (1998–2003) Global entrepreneurship monitor: data collection design and implementation. *Small Business Economics* 24(3): 205–231.

³GEM Report. Switzerland: the top-ranked country for ease of starting and developing a business. Global press release, GEM website, <https://www.gemconsortium.org>. Accessed May 26, 2020.

project, including services companies, domestically oriented businesses and agricultural companies—all outside the focus of this present study. Thus, the specific interest here is in finding the underlying factors that contributed to the high performance based on the described practices at the heart of this large concentration of exporting manufacturing companies.

Based on the company interviews, as well as the literature review, several supporting factors that contribute to the prevalence of exporting, manufacturing-based SMEs could be identified.

- Tradition for practical orientation among the Swiss population: *techne* versus *episteme*.
- Dual-track educational system with a strong vocational tradition.
- Engineering culture with a knack for ingenuity and innovation.
- Cooperative governance practiced across many levels of Swiss society.
- Deeply rooted work ethic.
- Distinct business management philosophy different from the Anglo-Saxon type.

In the following sections, each of these elements listed above will be examined further.

Techne vs. Episteme: A Wall Street Banker's Observation

Most readers are probably familiar with the writings of Nassim Nicholas Taleb of Black Swan⁴ fame and author of a later book entitled *Anti-Fragile*.⁵ Taleb spent some time working in Zurich in his early banking and investment advising career. From that experience, he observed that Switzerland, despite its success (he calls it arguably the most successful country in history), had traditionally produced a low number of university graduates compared to other highly developed nations.

Taleb observed that, even in banking, the Swiss apprenticeship model with its emphasis on vocational education departed from other financial centers, which tend to rely on university-based, theoretical training. This prompted Taleb to describe a particular balance achieved and maintained between *techne*,⁶ a preference for crafts and representing know-how, and *episteme*,⁷ standing for learned knowledge or know-what, that he viewed unique to the Swiss educational system and one that has been prevalent throughout Swiss industry.

Earlier visitors to Switzerland had noticed the same orientation. *André Siegfried* (1875–1959), a renowned French geographer and political scientist, as well as member of the Académie Française, traveled through Switzerland shortly after

⁴Taleb, N (2008) *The black swan*. Penguin Books, London.

⁵Taleb, N (2012) *Anti-Fragile*. Things that gain from disorder. Penguin Books, London.

⁶*Techne*, a term derived from Greek and meaning craftsmanship or art. Ibid, p. 90.

⁷*Episteme*, a term derived from Greek, to indicate knowledge. Ibid.

WWII, recording his impressions of people, industry, and the country's political system. "Swiss industry is the daughter of a magnificent double tradition, artisan and scientific; the one born in the uplands of the ingenuity of the peasants, the other born of the splendid civilization of Switzerland's towns since the Middle Ages. Together, they formed a basis on which the Swiss qualities of industry and intelligence coupled with an advanced technique could develop in full."⁸

Jean-Pierre Etter, founder of **LEM**, one of the companies profiled in this book, pointed out the importance of not confusing knowledge with know-how. Losing the ability to differentiate between those two forms of knowledge could lead to recording masses of unverified information while at the same time lessening a capacity to do something real. "To verify one's knowledge in industry is to be capable of applying in practice what one has learned in theory. Thought should not be based on abstract knowledge but reflect reality. Man thus achieves true knowledge of reality. Today, people no longer submit to this discipline and this is why belief or pure knowledge prevails over know-how."⁹

Etter considered this to be a dangerous development and thus strongly favored know-how over knowledge or know-what. Clearly, there is a long-standing tradition in Swiss society that appreciates the difference and favors know-how, or skills, over only the know-what.

Swiss Dual Education System

At the heart of the Swiss emphasis on skills and know-how was the country's dual-track educational system. Compared to other European countries, the Swiss educational system produced a remarkably low percentage of university graduates in relation to the working population. This was even more astounding since a highly technically oriented industry required a workforce with top qualifications. With only about 20 percent of young Swiss graduating with a maturity,¹⁰ 30 percent, if one includes the related program combined with an apprenticeship, Switzerland lags considerably behind other countries such as Finland, Sweden, Italy, or the EU on average (63 percent).¹¹ Even Germany, another country that has a dual educational system, exceeds the percentage of Switzerland, considerably.

Complementing the aforementioned academic pathway, the Swiss system of apprenticeships was the backbone of skilled workers' training and actively supported by industry, as was pointed out in our analysis of Swiss SMEs. These programs, typically of three or four years in duration, graduated highly skilled professionals in many different job classifications annually, particularly in

⁸Siegfried, A (1950) *Switzerland: A democratic way of life*. Jonathan Cape, London.

⁹Etter, JP (1994) *Start small, grow big, stay human and conquer the world*. Editions Slatkine, Geneva.

¹⁰The Swiss Maturity is the qualification that leads to entry into universities.

¹¹Strahm, RH (2014) *Die Akademisierungsfalle*. HEP Verlag, Bern.

manufacturing-related industries. Swiss apprentices regularly competed in the international Olympics for apprentices where they consistently won medals. For example, at the 2017 World Skills Competition in Abu Dhabi, Switzerland as a nation came in second only behind China; Korea was ranked third. Switzerland's 36 participants earned 33 medals and recognitions (11 Gold, 6 Silver, 3 Bronze, and 13 Medals of Excellence), many of those in metalworking occupations.¹²

A former CEO of one of our interviewed companies provided this vignette, illustrating the strength of technical skills on the machine shop floor of one of these companies. "My company at that time acquired a new and sophisticated machining center from a German supplier. The company arrived with the equipment, installed it and turned it over to us. The supplier left us with three keys: 'Blue is for top management of your company and controls all of the parameters of the equipment; Red is for your technical and engineering staff to arrange for the machine set-up and programming; Green is for equipment operators on the shop floor and will turn the equipment on and off'. The machine supplier was puzzled when I told him 'Everyone here in this company gets a blue key'!"¹³

This is just one example of the technical skills present from bottom to top, feeding the companies with the necessary talent to compete globally.

Completing an apprenticeship program does not mean that the person remains at the skilled operator level for the rest of his or her professional career. As was pointed out in Chapter 2, many of the founders of the researched SMEs were graduates of apprenticeship programs who later completed additional education, mostly in management. This was not only the case for companies started decades ago, but it also applied to firms founded more recently (**Wyon, Medartis**) and many of the firms owned and managed today (**Sylvac**).

To perpetuate and support the dual education system, virtually all companies interviewed were active participants in the apprenticeship system, the numbers of apprentices in training ranging from a few to as many as 50 or more (**Komax, maxon, Pilatus**), depending on the size of the workforce.

"We at **maxon** train currently about 50 apprentices. We would like to double that. To achieve this, we will have to recruit more regionally for our program and possibly even offer dormitory-style housing."¹⁴

A Knack for Engineering Ingenuity

A perceptive analysis of the practical orientation of Swiss science was rendered by *Denis de Rougemont* (1906–1985), the renowned Swiss writer and political scientist, describing some of the Swiss scientists who made important contributions in the

¹²World Skills 2017 in Abu Dhabi, Medal Count by Country. <https://worldskills.org/what/competitions/wsc2017/>.

¹³Example provided by Beat Kaufmann, former CEO of DC Swiss.

¹⁴Interview with Eugen Elmiger, CEO, maxon, January 22, 2019.

eighteenth Century. Contrasting the Swiss approach to engineering with the one practiced in the USA, Rougemont pointed out that Swiss engineers, partly due to a lack of natural resources, could not compete with, and would not develop, the largest of anything, or engage in mass-produced products. Instead, the Swiss engineering approach was to create, for instance, the smallest watch, not the biggest one.

“Combining a taste for beauty and form in their work with a traditional appreciation for precision in manual labor, the Swiss felt compelled to add a new factor to their competitiveness leading to a novel approach to compensate for their handicap in market size: technical ingenuity and inventiveness, relying on a particular scientific tradition.”¹⁵

Rougemont cited the experience of the Basel mathematician *Leonard Euler*¹⁶ who found himself in need of proving the practical applications of his mathematical research, such as the creation of the differential and integrational calculus, by following up with a plan how to build turbines. Likewise, the *Bernoulli* family also expanded their mathematical knowledge developing the fundamental laws of mechanical engineering. To this day, industry worked on the basis of these mathematical models and, applied to statistics, these models found their way into the insurance industry.¹⁷

Siegfried, contrasting the Swiss approach to the mass approach practiced in other countries, describes Swiss industry as follows:

“They concentrate on specialization, on quality, on diversifying models rather than simplify them, in short, they ‘build to a specification’. They are prepared to make innumerable adjustments, corrections and alterations; they prefer a reduced series, or even a succession of different products each treated as a thing in itself, to automatic production in series involving a rigid tooling-up; with that policy they accept the necessity of long and patient effort involving extended research and continued adaptation.”¹⁸

The engineering orientation of many of the company founders in this book was evident from glancing at their backgrounds, and the same applied to checking up on the professional backgrounds of the managers leading many of these firms today. The major educational institutions at the forefront of educating these talents were the Federal Institute of Technology in Zurich (ETH) and its sister institution in Lausanne (EPFL), as well as a number of engineering departments, which are now part of the University of Applied Sciences system. The ETH Zurich followed a long tradition for merging science with practical applications. With 32 Nobel Prize Laureates associated with ETH Zurich, the institution was ranked sixth worldwide by the QS

¹⁵de Rougemont, D (1970) *La Suisse ou l’histoire d’un peuple heureux*. Le Livre du Mois, Lausanne. Translated from French by the authors.

¹⁶Leonard Euler (1707–1783).

¹⁷The Basel Bernoulli family produced a number of outstanding mathematicians including Jacob Bernoulli (1655–1705, calculus), Johann Bernoulli (1667–1748, calculus), Daniel Bernoulli (1700–1782, fluid mechanics, probability, statistics).

¹⁸Siegfried, Op. cit.: 75–76.

World University Rankings and its sister institute, EPFL 18th. Among these top universities, both ETH and EPFL are two of only three institutions located in a non-English-speaking country.¹⁹

The technical education of company staff in Switzerland was complemented by a number of Universities of Applied Sciences which, given their practical orientation, were a strong source of technical talent for Swiss companies. Many of the firms in this research maintained close ties to such institutes, engaging frequently in joint projects. Many of the leaders of today's SMEs attended such institutions, sometimes prior to going on to graduate from ETH Zurich or EPFL Lausanne.

To summarize, Swiss science and engineering institutions have a long tradition of being connected to solving practical problems, supporting the innate drive of industry toward innovative solutions with practical applications.

Tradition of Cooperative Governance

Observers of political life in Switzerland have often commented about the special manner in which groups, parties, and communities interact with one another, greatly influencing the governance of Swiss enterprises.

Siegfried, writing about this phenomenon after his Swiss visit in 1950, described it as follows:

“The Swiss as a nation are the result of a balance of forces between a triple centrifugal cultural attraction and a triple centripetal political attraction. Three races, three, even four languages, and two religions, are associated in a political group which does not strive for ethnic, language, religious or cultural unity; yet, the result is an exceptionally united and an exceptionally national nation. How did this paradoxical result come about?”²⁰

More recently, one of the authors, in private conversations with Stef Wertheimer, a leading Israeli entrepreneur with roots in Southern Germany, always returns to a similar question²¹: “How come the Swiss have managed to overcome all these differences and build a such a strong export-oriented economy?”

Wertheimer, the founder of Iscar, a high-tech company producing tools for demanding metal cutting applications and which is active globally, was the creator of the Tefen Model. After stepping down from managing his company, Wertheimer spent much of his energy on creating German-style apprenticeship programs in Israel to foster some of the same educational effects he has observed in Switzerland.²²

¹⁹QS Global University Rankings 2020. <https://www.topuniversities.com/university-rankings/world-university-rankings/2020>. Accessed June 16, 2020.

²⁰Siegfried, Op. cit.: 121.

²¹Private conversations held by Jean-Pierre Jeannet with Stef Wertheimer, Israeli entrepreneur, on several occasions over the period of 2010 to 2018.

²²Wertheimer, S (2015) *The habit of labor*. Overlook Duckworth, New York/London.

Wertheimer is also a great admirer of the Swiss political system and its impact on the Swiss economy.

Two conversations with French executives who moved to Switzerland to manage and build companies help explain the differences and particularities of the Swiss political environment. The first conversation took place with a young entrepreneur who had crossed the border from France to work in Switzerland, working in both countries in the watch industry. When asked to reflect on the different experiences, he answered in a rather unexpected way.

“I moved from the French Jura, working for a French watch company, to the Swiss side, to the La Chaux-de-Fonds region to be specific, also working for a watch company. The difference that struck me most was what happened when we went for lunch. Here in Switzerland, everyone went to a nearby restaurant, sitting at long tables, all ranks, functions, hierarchies mixed, enjoying lunch together and engaging in conversation. My previous experience in France was radically different: everyone sat at separate tables, according to rank, social status and function.”²³

The company profile on **Selectron** details another example of how the governance tradition in Switzerland combines with leadership styles at SMEs. The protagonist at Selectron, Emmanuel Hannart, was parachuted in from the Paris head office of a large global company into heading this fledgling business during difficult times. As he negotiated with local governments, he became familiar with the Swiss political style of *concordance*, or democracy by consensus, versus democracy by dominance based on majority rule. Hannart believed that the Swiss, used to practicing *concordance* in many aspects of their lives, were able to overcome disagreements without imposing a solution on everyone. He applied this principle successfully when Selectron company was sold to a much larger German firm.

*The deal with Knorr included a three year earn-out period that, if successfully delivered, determined as much as 20 percent of the acquisition price. Hannart and his team were able to convince Knorr to base this acquisition not on a merger basis but on the basis of concordance, or mutual agreement of governing issues, and with operating autonomy.*²⁴

That such a governance system influences the practice of management within many SMEs has deep roots in the cooperative structure of the Swiss society. This is also documented in the work of Elinor Ostrom, the Norwegian Nobel Prize winning economist who studied cooperative arrangements in many societies.²⁵ Among her examples of *Common-Pool Resource*, or CPR²⁶ units, were Swiss cooperative arrangements about the management of water used among mountain

²³Conversation with Emmanuel Raffner, CEO, Lauener & Cie SA, Boudry (NE).

²⁴The term “concordance” was derived from German “Konkordanz” to describe the particular governance system used in Switzerland involving all major parties and striving for consensus rather than being overruled by a dominant party in a “Dominanz” system. This model had been adopted in Switzerland by many civic and business organizations as a governance model. Adapted from Selectron company profile.

²⁵Ostrom, E.: *Governing the commons*. Cambridge University Press, Cambridge, UK (2015).

²⁶*Ibid.*, p. 30.

farmers in the Valais. “In Switzerland, individuals are responsible to others and to oneself. This makes a difference for an entrepreneur working in Switzerland compared to France.”²⁷

A Deeply Rooted Work Ethic

While many international observers have often discussed the Swiss work ethic, two recent popular votes have probably added much to its reputation.

- In 2012, Swiss voters defeated an initiative to grant themselves an increase in mandatory vacation annually from four to six weeks with 66 percent of the voters voting *No*.
- In 2016, Swiss voters defeated an initiative to establish a guaranteed minimum income, with 77 percent voting *No*.

Many observers of Swiss society have commented on the industriousness of its population. One of the early recorded commentaries was made by *Jean-Jacques Rousseau* (1712–1778), remembering his stay in the Jura mountains when he was about 20 years old; he remarked on the craft orientation of local farmers and their engagement in all kinds of cottage industries, later to become the base of the watch industry.

“They . . . make countless artifacts with their hands and put to use their inventive genius which nature gave them. . . . They . . . invent and make all sorts of instruments of steel, wood and cardboard. . . . They . . . even make some watches. . . . And, what seems unbelievable, each joins in himself all the various crafts into which watch-making is subdivided and makes all his tools himself. . . . They make syphons, magnets, spectacles, pumps, barometers and cameras obscura [sic]. Their tapestry [sic] consists of masses of instruments of every sort; you would take a farmer’s living room for a mechanic’s workshop and for a laboratory in experimental physics. All know how to sketch, paint and calculate a bit; . . .”²⁸

More than 200 years later, Rougemont, wrote about the Swiss and their work ethic. “Industry can rely on their taste for work (*le goût du travail*) as central for the Swiss, both the base for their social contacts and even more so for their own life. And in many death announcements, one can find the note ‘Work was his life.’”²⁹

Siegfried confirmed Rougemont’s assessment of the Swiss and their traditional work ethic, partly influenced by a scarcity of natural resources. “The absence of oil and coal, for beyond all doubt some good fairy waived her wand over the cradle

²⁷Conversation with Emmanuel Raffner, CEO, Lauener & Cie SA, Boudry (NE).

²⁸Rousseau, JJ (1960) *Politics and the arts* (Letter to M. D’Alembert on the Theatre, written 1758). Cornell University Press, Ithaca, NY.

²⁹de Rougemont, D Op. cit.

declaring: And you shall have no coal. In this way, Switzerland was saved from the temptation of mass production and condemned to superiority.”³⁰

At the front of his book about Switzerland, Siegfried quoted a fable written by *Jean de la Fontaine* (1621–1695), a French poem entitled “The Farmer and his Children.”³¹ In the fable that begins with “work hard, sweat all you can, riches is what counts the least,” La Fontaine recounts the story of a rich farmer who, prior to his death, pleaded with his children not to sell their inheritance, as a treasure was hidden somewhere on the land, on a location unknown even to him. He encouraged his children to go and search for it by turning the earth over after the harvest. After his death, the sons turned over every corner of the land, without ever finding the treasure. The land, however, yielded more than ever before. In this way, the old farmer showed his family that work itself was the treasure and that wealth did not count.

The reputation of a strong work ethic is also supported by a number of more current government statistics. According to OECD, Swiss workers labor 42.5 hours per week in industry, putting in about 5 to 10 percent more hours annually in comparison to workers in competing European countries.³²

The Swiss, however, enjoy higher wages than employees in most competing European countries. In his analysis, Rudolf Strahm pointed out that it was not pay per hour that mattered, but labor productivity instead.³³ Based on data from the IMD World Competitive Yearbook from 2004 and 2007, Switzerland was listed as the sixth most expensive country in labor costs per hour, but fifth in productivity per hour. Netting the two generates a form of *margin earned per man-hour*, and, at 66 percent, it is higher for Switzerland than the neighboring, competing exporting countries of Germany or Austria, and in line with Korea.³⁴

Where Switzerland surpasses competing countries is not so much in the net margin but in the actual monetary amount (gross profit) per hour worked, which is, on average, double that of competing countries. Combining the higher number of hours worked per year (about 10 percent) with the much higher productivity per hour explains why Swiss industry is able to compete globally from one of the countries with the highest cost base in the world. The experience of **maxon** confirms this observation. Despite the wage level differences, the Swiss operation was still competitive on the basis of profit per person, the key operating metric used at maxon. The indirect costs at the Swiss operation were about two-thirds, with one-third for direct production.³⁵

³⁰Siegfried, A (1950) *Switzerland: A democratic way of life*. Jonathan Cape, London.

³¹*Ibid.*, p. 68.

³²OECD: OECD. Stat, Average annual hours worked per worker (2019).

³³Strahm, RH (2010) *Warum wir so reich sind (Why we are so wealthy)*. Hep Verlag, Berne.

³⁴Netting means taking the difference between value-added per man-hour minus cost per man-hour to arrive at a value for net contribution per man-hour.

³⁵Adapted from maxon company profile.

Swiss Management Philosophy

A few years ago, a group of executives from different countries were brought together at Babson College, in the USA, to discuss differences in management styles between the USA, Europe, India, and China.³⁶

Speaking for the US management community was a former auto industry executive and private equity investor with a Wall Street background. He went on to explain how financial analysis was driving much of the management decisions—the importance of both short-term views and profits, acquisition for company growth, and the role of the CEO as a person and individual leader.

The Indian executive talked about combining *Western Ways* and *Eastern Productivity* with an emphasis on spiritual aspects and human resources, while the Chinese business owner placed family values based on religious traditions such as Taoism, Buddhism, and Confucius, as well as personal relationships being in the forefront.

The European representative, CEO of a large Swiss biotech firm, was more direct in saying: “We could not function with so much emphasis on finance as European employees need more than that to motivate themselves, such as a social purpose.”

This response shows clearly that the traditional European and even more so the Swiss management philosophy are distinctly different from a financially driven approach sometimes described as a *Wall Street type*.

The business environment in Switzerland has undergone considerable change over the past decades, with a more financially driven style finding its way into many, usually larger companies. Still, among smaller firms what is sometimes referred to as *Swiss SME-type* management remains prevalent. This philosophy, in many ways, shaped the management practices of the documented firms and, as described as the *Swiss management style*. The difference between the Swiss and Anglo-Saxon management styles was also found in research covering a number of countries.³⁷

The experience of Victorinox, a Swiss business best known for its pocket knives, and a company that was part of our original long list of 100 firms for this book, is highly relevant to this discussion. Carl Elsener, CEO and representative of the founding family’s fourth generation, was recently quoted in an interview.

“We think and plan in terms of generations, at the stock exchange the focus is on the next quarter and shareholder value — this is inconsistent with our philosophy. As an alternative to an IPO, our family created in the year 2000 a foundation holding 90 percent of the company shares.”³⁸

³⁶Babson College, Wellesley MA, USA, April 9, 2008, on the occasion of the Babson Academy of Distinguished Entrepreneurs: (Thomas Stalkamp, Babson Board of Trustees, Ernesto Bertarelli {Switzerland}, Sunil Bharti Mittal {India}, Lee Man Tat {China}).

³⁷House, RJ, Dorfman, PW, Javidan, M, Hanges, PJ, de Luque, MFS (2014) *Strategic leadership across cultures: the GLOBE study of CEO leadership behavior and effectiveness in 24 countries*. SAGE Publications, London.

³⁸“Wir denken und planen in Generationen – nicht Börsenquartalen,” interview with Carl Elsener, CEO of Victorinox, June 11, 2020 (Neue Zürcher Zeitung, International Edition).

Switzerland: Exception or Role Model?

Several company profiles reveal that some of the founders of, and prime movers in, these SMEs hailed from abroad, finding fertile ground in Switzerland for their entrepreneurial endeavors. This was the case for **Sefar** (France), **maxon** (Germany), and **Datamars** (Italy); a number of the later movers, or owners, in other companies also came from neighboring countries, such as in the case of **Fraisa** (Germany) and **Selectron** (France).

It would have gone outside the scope of this project to investigate in greater detail the experience of SMEs in other countries. By chance, a story surfaced at the time that this text was being finalized. Although the example cited in this story comes from a publishing company in Italy, and not an export-oriented manufacturer, the history of Casa Editrice Hoepli in Milan serves as an anecdotal example, raising an intriguing question: To what extent do the practices of Swiss SMEs apply elsewhere, if attempted?

Johann Ulrich Höpli (1847–1935), a Swiss-born entrepreneur, trained as a book-seller in Zurich, emigrated to Milan in 1870 where he acquired a bookstore. Known as Ulrico Hoepli, he turned the bookstore into a successful publishing venture, Casa Editrice Hoepli. He remained childless and left the business to his nephews.³⁹ One hundred and fifty years later, the business was still operating, owned, and managed by the founder's descendants. Barbara Hoepli, now the board chair, runs the company together with two brothers; they are part of the 5th generation. The company publishes about 300 new titles annually and maintains a publishing list of more than 2000 titles, focused in the areas of manuals, educational books, and languages. In a recent interview, Barbara Hoepli explained some of the principles that were at the core of the firm's success.⁴⁰

- We are strongly engaged in niches, something that has always been our strength.
- One of our niches are languages, such as Russian for Italians, Italian for Chinese.
- In the segment of dictionaries, we are market leader.
- We are experts for books, books are our product, and we are selling nothing else.
- As good Swiss, we have no debts, pay our employees their monthly salaries, and earn sufficient funds to finance the necessary investments.

The comments made by Hoepli are strikingly similar to the principles and practices espoused by Swiss SMEs: privately owned, focused on a market niche and being financially self-sufficient are all principles followed by the SMEs described in this book. This story was deemed sufficiently intriguing to share with readers, encouraging the idea that the principle of Swiss SMEs can also be

³⁹Jung, J, Hoepli, U (1977) Am literarischen Webstuhl. Neue Zürcher Zeitung, Zurich.

⁴⁰Gallarotti E (February 1, 2020) Unser Produkt ist das Buch. Interview with Barbara Hoepli. Neue Zürcher Zeitung, Zurich.

successfully applied in other countries; this in the hope of serving not just a Swiss public but a wider international audience as well.

Reflections

This chapter is written with the expectation that some thought might be given to the fact that, on one hand, the practices described in this book did not take place in a complete vacuum but, instead, were born in an environment that favors a given type of management thinking and, on the other hand, many companies in Switzerland have benefited from the Swiss ecosystem without ever achieving what is profiled in the book's company profiles and without reaching the lifespan of the companies documented. This confirms that success has not been automatic and that a large part of the success over the long run, in fact, needs to be credited to individual entrepreneurs, managers, or SME ownership.

The authors are keenly aware that similar companies in Germany and Austria, with related philosophies and orientation, operate successfully. This observation leads to the question, if such a *Swiss SME Model* existed, could it be duplicated elsewhere, outside of Switzerland? Or, alternatively, has the study simply discovered certain practices that can lead to long-lasting and successful firms elsewhere? To conclusively test this hypothesis was beyond the scope of this project. However, it is intriguing. We leave the readers to ponder the question.

Open Access This chapter is licensed under the terms of the Creative Commons Attribution 4.0 International License (<http://creativecommons.org/licenses/by/4.0/>), which permits use, sharing, adaptation, distribution and reproduction in any medium or format, as long as you give appropriate credit to the original author(s) and the source, provide a link to the Creative Commons license and indicate if changes were made.

The images or other third party material in this chapter are included in the chapter's Creative Commons license, unless indicated otherwise in a credit line to the material. If material is not included in the chapter's Creative Commons license and your intended use is not permitted by statutory regulation or exceeds the permitted use, you will need to obtain permission directly from the copyright holder.





What then are the implications of these research findings reported in *Masterpieces of Swiss Entrepreneurship*? And for which communities might they be relevant?

The analysis in the previous 24 chapters captures the authors' findings based on their extensive field research regarding the practices of successful, export-based, and, mostly, long-lasting SMEs. Those findings are connected solely to the data from these companies. However, over the extended period of time that the authors worked on this project, it is only natural that additional thoughts going beyond the sample companies came to mind.

These observations primarily concern the relevant implications for public policy and the business community at large, which move beyond the defined professional research scope. The observations accrued alongside the detailed company research but are intended for interested audiences in business, politics, education, media, and the larger society.

The authors believe it worthwhile to communicate these observations in the form of a working list rather than to formulate them as a complete chapter, or essay, which would need to take into account the entire social context, something which could easily exceed the scope of a chapter, as well as the competence of the authors.

The observations are not meant to be exhaustive; the authors hope that readers will add their own thoughts and ideas for future considerations beyond those offered here.

The list of ideas that follows is structured around communities of interest. Again, this list is not meant to be a policy recommendation, but rather a thought-provoking exercise encouraging the impulse to consider the question "And now what?"

Observations for Business and Managerial Community

- For Entrepreneurs and SME Managers
 - In addition to having the “Big Idea,” the mode of financing the enterprise needs equal attention.
 - There is value in ramping up slowly, relying on one’s own resources, however limited they may be.
 - Discovering neglected projects and assets in larger corporations might provide value.
 - Remaining close to the core technology of the venture brings long-term benefits.
 - Stay true to your focus and avoid going into markets just because they seem more glamorous.
- For Corporate Managers at Large Companies
 - Smaller units often do not receive sufficient attention from corporate management.
 - Significant value can be unlocked if smaller units are given more freedom of operation.
 - Operating Freedom vs. Independence: They are not the same; the former is more important for success.
 - Smaller, maybe overlooked, units that could benefit from a greater willingness to divest to managers.
- For Owners of SMEs
 - Owners need to grant professional management sufficient freedom of operation.
 - When small, it helps if owners are technologically involved and can take the lead in development.
 - Owners need to consider transferring ownership to professional management when encountering diminished entrepreneurial energy.
 - Selling ownership to the highest bidder (trade sale) is not always beneficial to SME culture and future perspectives of business.
 - Stability in ownership can take various forms, from single ownership to a larger group of shareholders.
 - Connect the next generation of owners to the business at an early age.

Observations for the Entrepreneurial Community

- For Future Start-ups and Aspiring Entrepreneurs
 - There is no age limit to becoming an entrepreneur.
 - Frugal and small ramp-up appears to be typical for many businesses.
 - Ideas for new businesses probably come from your existing business environment and experience: Look around.

-
- Understanding the technology of the relevant market is crucial.
 - Neglected businesses can be a good start for new owners to embark on their own business.
 - Wherever you work, always ask the question: Can this be done better, and: Can it spawn a business?
 - Opportunities are out there: You have to spot them and then capture them.
 - Start with your means: What you know, what you have, and who you know.
 - If you believe in your idea, get started even when resources are limited.
 - Inventors looking for companies to commercialize ideas should pursue smaller SMEs because they are more flexible in terms of adopting new ideas.

Observations for Financial Community

- For Bankers and Lenders
 - Smaller SMEs do not seem to like to depend on bank lending, since lenders have acquired a reputation for unreliability.
 - Bank lending to SMEs is typically preferred for SME mortgages only.
 - Larger SMEs are interested in obtaining financial support in case of major acquisitions.
 - Increased support for MBOs of small company units at larger corporations enable existing management to become owners.
- For Investors
 - Investors need to take a long-term view of their SME investments.
 - Financial investors in SMEs have a role to play as long as they are willing to grant company management considerable operational freedom.
 - Team and technology are two key factors to consider when investing.
 - Investors need to invest time and resources to understand and appreciate technology development in the company they target.

Observations for Consultants and Advisors

- Few SMEs rely on consultants for their business decisions.
- Technical expertise is at times hired on a consultancy basis.
- Having consulting experience can be helpful for jumping into an SME leadership/ownership role. However, affinity to the core technology of the company is required.

Observations for the Educational Community

- General Recommendations for All Levels
 - Promote business acumen, defined as the business, financial and economic parameters of any business. The term *business acumen* is used here in the sense of understanding: What is a business? How does it function? What are the financial parameters? It is different from a mere technical understanding of a business.
 - Teaching about entrepreneurship should be included in curricula at all levels, adjusted to school type and student age.
 - Understanding the SME environment and its opportunities is important and not only talking about the large companies that everyone knows.
- Teaching
 - Foster the development of practice-based material for entrepreneurial mindset and business acumen for all educational levels.
 - Include walking a factory floor with students into course curricula.
- Secondary Level
 - Concentrate on the basics of business acumen: How does a business work?
- Middle School (up to Maturity)
 - Economic history.
 - History of entrepreneurship in Switzerland.
- Apprenticeship Level
 - Teaching business acumen.
 - Teaching entrepreneurial concepts.
 - How to start your own operation, becoming economically independent—how to become a *Company of One* and beyond.
 - Open up apprenticeship programs for maturity graduates, and shorter versions for university graduates.
 - Appreciation of the technical skills as the basis for a business.
- Universities of Applied Sciences
 - Business Programs
 - Teaching of entrepreneurial concepts
 - Technical Programs
 - Teaching of entrepreneurial concepts
 - Teaching of entrepreneurship competencies and practices (Entrepreneurship Toolbox)
- Universities and Institutes
 - Technical (ETH Zurich, EPF Lausanne)
 - History of entrepreneurial contributions to Switzerland.
 - Teaching of entrepreneurial concepts and practices.
 - Business and economic acumen.

-
- Business Programs
 - History of entrepreneurial contributions to Switzerland
 - Readiness to take on entrepreneurial roles at all professional levels and ages.
 - Teaching of entrepreneurship for SMEs (Entrepreneurship Toolbox).

Observations for Political and Governmental Community/Public Policy

- Policy Areas
 - Promote not just start-ups but also SME continuation.
 - Policy actors shaping public policy should acquire business acumen, to be able to engage with SME community.
 - Focus on policies that favor maintaining ownership of companies with founders/families:
 - Facilitating transition from one generation of owners to another (fiscal policies).
 - Making MBOs or similar moves (more) affordable to employees and management (fiscal policies).
 - Ensure rural accessibility of SME sites through infrastructure support, for example, public transport, telecommunications, and infrastructure, expanding the hiring pool radius.
 - Strengthen attractiveness of apprenticeship programs and promote value of dual educational pathways.
 - Ensure high-quality standards for teaching personnel at all levels.

Observations for Members of the Media

- Show that entrepreneurship is not just for Silicon Valley; it can take place everywhere, every day.
- A stronger understanding of business and entrepreneurial endeavors in society is needed.
- Entrepreneurial achievements could be more visible in society.
- Increased coverage of the history of SME contributions to Switzerland.
- Share the stories about the daily life of SMEs, and celebrate their achievements.

Observations for Society at Large and Individual Citizens

- Curiosity and tolerance of entrepreneurial endeavors.
- Acceptance of the entrepreneurial success of others.
- Nurturing a *can-do* spirit where people can trial their idea at minimal cost and learn from failure.
- Celebrating entrepreneurial effort and success.
- Entrepreneurial failure should not become a social stigma.
- Raising the entrepreneurial profile—moving from employee thinking to an entrepreneurial “*copreneur*” attitude with proactive thinking, and open to ownership initiatives.
- Investing in effort and training to prepare for becoming a manager or owner.

Open Access This chapter is licensed under the terms of the Creative Commons Attribution 4.0 International License (<http://creativecommons.org/licenses/by/4.0/>), which permits use, sharing, adaptation, distribution and reproduction in any medium or format, as long as you give appropriate credit to the original author(s) and the source, provide a link to the Creative Commons license and indicate if changes were made.

The images or other third party material in this chapter are included in the chapter’s Creative Commons license, unless indicated otherwise in a credit line to the material. If material is not included in the chapter’s Creative Commons license and your intended use is not permitted by statutory regulation or exceeds the permitted use, you will need to obtain permission directly from the copyright holder.



Part IX
Company Profiles



This final chapter, containing the full-length profiles of each of the 36 companies representing the base of this research project, plays an integral role in *Masterpieces of Swiss Entrepreneurship*. Although the various profiles have been quoted extensively as part of the analysis in the previous chapters, those excerpts were used to illustrate a particular concept, finding or practice. A reader, going through the previous chapters, cannot possibly gain a comprehensive understanding of the history and trajectory of a given company in the main book text; this section allows for a more in-depth reading, one company at a time. The company profiles are organized in the order of when each of the enterprises was founded.

As has been pointed out previously, the profiles were established based on diligent background research and at least one company interview. This process was concluded in 2019, with many of the interviews taking place in 2018. By the time this book is published, up to 3 years may have passed between the time of the interviews and the book's publication. The authors believe that since the focus of this research reflects the entire life of a company, having up to 3 years pass between case study research and publication does not pose a major issue. The key is the trajectory of each of the firms and that has not changed.

However, it is true that in the intervening 2–3 years, changes have taken place at several of the companies. Management changes in several firms have been observed, as well as some changes in ownership. Last but not least, the COVID-19 pandemic has impacted the entire global economy, although the impact on individual firms has differed considerably. Continuously updating the last segments of each company would have resembled the proverbial changing the wheels on a moving train. The main findings around management practiced have not fundamentally changed since the work closed on this research.

The listing of these 36 companies by their founding date corresponds to the listings in Tables 2.1 through VIII.1 used for each section in the book (Parts I through VIII) and serves as an introduction for the analysis.

Company Profile 1: Sefar¹—A Big Business Based on Small Holes. From Cottage Weaving to Industrial Enterprise

The beginning of Sefar dated back to 1830 when Pierre A. Dufour began producing silk bags for flour sieves. Almost 190 years later, Sefar still produced technical fabrics. In 2018, the company was the world's leading manufacturer of precision fabrics from monofilaments for screen printing and filtration markets. Sefar's products were widely used in medical, automotive, food, and pharmaceutical industries, as well as in chemicals and raw material extraction, architecture and screen printing applications on PCB, glass, textile, and for graphics. The Sefar Group operated subsidiaries and fabrication centers in 26 countries on six continents, serving customers in more than 90 countries. Sefar owned weaving mills in Switzerland, Romania, and Thailand, as well as yarn production in Switzerland, Poland, Romania, and Mexico. In 2018, the company generated sales of CHF 342 mio, employing approximately 2800 people worldwide, of which 800 were based in Switzerland.²

Business Founded in a Small Village

The Bodmer family, active in the silk industry for decades, was among the wealthiest Zurich families. In the late 1820s, the Bodmers hired young and entrepreneurial Pierre A. Dufour (1797–1842) from Lyon, then the capital of the European silk trade, as a traveling trader. On behalf of Heinrich Bodmer, Dufour searched for possibilities for producing silk gauze in Eastern Switzerland where a centuries-old weaving tradition and a correspondingly large number of qualified weavers existed, typically producing fine cotton fabrics on simple looms in the basement of their homes. Cotton weaving machines increasingly replaced manual weaving, reducing income of home-based workers, depressing wages, and leading to poverty in the region. With good transport connections to Zurich and favorable climatic conditions in the typical weaving cellars that were installed in the basements of the Appenzell homes, Dufour experimented with silk gauze production after some research on production processes used in Holland. In 1830, Dufour succeeded in weaving the first silk bag cloth on a converted cotton loom owned by a weaver in the small village of Thal in Eastern Switzerland, where he subsequently established the production of silk bag cloth.

When Dufour and Bodmer split in 1833, Dufour struck out on his own and founded Dufour & Co. in Thal. Dufour & Co followed a simple business model, assigning work to independent homeworkers who wove their pieces in home-based

¹This case was written by Heiko Bergmann (Adjunct Professor of Entrepreneurship University of St. Gallen) on the basis of a company interview as well publicly available information. Copyright©2019.

²Killer P (2005) 175 Jahre Sefar, am Anfang war das Seidenbeutel Tuch, Sefar AG, Rüschiikon.

weaving cellars, delivered them to Dufour & Co to be inspected, repaired if required, made up, stored, and finally sold. The company grew and employed dozens of home-based weavers, according to this business model without the need for a central factory building.

Capitalizing on the Industrial Revolution Changing Grain Processing

In the course of the industrial revolution, with the increasing spread of steam engines, grain processing changed from artisanal to industrial production. Flour mills that were built at the beginning of the nineteenth century were heavily automated, allowing for uninterrupted grinding. Separation of ground material from bran was improved by bag rolls covered with silk gauze. These new processes allowed an optimum flour yield, requiring high-quality silk gauze for the sieving equipment, increasing the demand for high-quality silk gauze.

Internationalizing from the Start

As early as 1835, Pierre A. Dufour made his first business trip to the USA and succeeded in winning customers. At this time, a trip to America could still be a real adventure. The ship crossing would take almost 30 days and was not without danger. However, Dufour & Co was not the only one having international customers early on. Bodmer, who had set up his own firm in the same industry based on homeworkers in Eastern Switzerland, also succeeded in supplying flour mills in a number of different countries. In 1839, Dufour made his second trip to the USA and, soon after, met and married Anna Joséphine Onofrio (1817–1901) in Lyon. Because the demand for silk bolting cloth was greatest in industrialized countries where large, modern mills operated, the USA became an important market. By the end of the nineteenth century, half of the production of Swiss silk gauze was exported to the USA. Although priced above competitive products from other countries, a special weaving technique combined with experienced weavers yielded superior quality.

Widow Leading Company to New Heights

Dufour died unexpectedly in 1842, returning from his third US trip. Her husband's death must have been a considerable blow to Anna Joséphine Dufour-Onofrio, his young widow. The couple had only been married for 2 years with a child barely 1 year old. Although Mrs. Dufour, now a single mother at only 25 years of age, who had moved 2 years earlier from Lyon to Thal and had shown a strong interest in her husband's business, was nevertheless expected to return to Lyon with her infant son Antoine (1841–1889). However, Mrs. Dufour remained in Thal, assuming management of the company employing about 50 home-based weavers and, presumably, a

similar number of employees for the preparation of yarn, shipping, and general office work, growing the company in subsequent years.

At the 1855 World Exhibition in Paris, Dufour-Gauze was awarded the first-class silver medal. But “Madame Dufour,” as she was typically called, not only possessed exceptional entrepreneurial and commercial skills, she was also a socially thinking woman active in the local women’s association, had a hospital built and funded, and enabled a workers’ support and pension fund. Overall, she played an important role in the development of Swiss industry.

Enter the Tobler Family

Mrs. Dufour’s son Antoine did not show the same enthusiasm for the business as his mother, eventually moving to Lucerne. Madame Dufour, realizing that her son was not up to the tasks awaiting him at the business, began the deliberate process to groom a potential successor.

Christoph Tobler (1838–1907), son of a local farmer, joined the company in 1855 as an apprentice. Joséphine Dufour appreciated the bright, diligent, and eloquent young man and entrusted him with more and more managerial tasks. In 1872, when a partner retired, Christoph Tobler received a share in the profits and in 1890, after son Antoine Dufour had died, became co-owner and partner in Dufour & Co. His brother, August Tobler (1844–1906), later also became managing director and co-owner. While Christoph Tobler traveled the world and created new customer contacts in Eastern Europe and the USA, August Tobler mainly worked at the company offices in Thal. Christoph Tobler had 16 children, five of whom ended up holding senior positions in the company. By 1900, the company employed around 1000 people in the region. Joséphine Dufour-Onofrio died in 1901 at the age of 84.

Proceeding with a Great Merger

With the production of silk gauze turning out a lucrative business, competitors soon entered the scene, typically pursuing the same business model as Dufour & Co, relying on homeworkers in Eastern Switzerland. At the end of the nineteenth century, no less than seven Swiss companies produced silk gauze, with Dufour & Co the largest. All competed for the same customers on international markets, offering a product of largely similar quality, leading to price competition.

On the initiative of Christoph Tobler, in 1907, six firms merged to form a single company with two separate business units, Schweiz. Seidengazefabrik AG in Thal (SST) and Schweiz. Seidengazefabrik AG in Zürich (SSZ). Five years later, Züricher Beuteltuchfabrik (ZBF) joined the union. The union dominated the world market for silk bolting cloth. Although established as a single legal entity, SSZ, SST, and ZBF operated independently on the market, presenting themselves independently to take advantage of their respective brands, until finally merging in 1995 by creating Sefar

(derived from Seiden-Fabrikanten Réunion, i.e., united silk manufacturers) as a registered limited company.

Opening First Subsidiaries Abroad

With the majority of production exported, internationalization was soon taken to the next level. In 1900, Dufour & Co founded its first subsidiary in New York.

When the French producers of silk gauze increasingly threatened Swiss producers with lower-priced products, SST, in consultation with its Zurich sister company SSZ, went on the offensive, establishing a weaving plant in Panissières, France, headed by Hermann Tobler. Later, rival companies were bought out. In 1929, the subsidiaries of both SST and SSZ operating in the North American market merged into a single company under the name Tobler, Ernst & Traber Inc., abbreviated Tetsilk.

Because of the heavy reliance on imports and exports, both world wars hit the company hard, and they managed to recover both times.

Changing the Production Model

For decades, silk gauze had been produced on manual looms. The market for silk gauze, being rather small, reduced the incentive to develop dedicated mechanical looms. In addition, silk was more difficult to handle than cotton. At the beginning of the twentieth century, SSZ conducted first trials for mechanical silk weaving, experimenting in 1930 with electrified looms. In 1932, the first mechanical loom was put into operation at SST in Thal. Mechanization of silk gauze production took off, and mechanical weaving machines gradually replaced manual looms. Since production so far had been carried out by homeworkers, the new machines required proper production facilities. After more than 100 years of heavy reliance on home production, the first factory was built in Thal in 1937, signaling the commencement of industrial silk gauze weaving. The last handweaver, Johannes Graf, retired in 1978.

Sefar's CEO Christoph Tobler considered production skills as one of the company's key success factors. Over the last decades, Sefar had bought standard weaving machines from local machinery suppliers. Upon delivery, Sefar optimized its machines, using custom-designed parts from local manufacturers to make them 10% more efficient and enhancing quality of output. Sefar did not patent any improvements in weaving technologies but tried instead to keep its process innovations confidential. Weaving machine manufacturers were never allowed to enter Sefar's weaving plant. When buying a new machinery, manufacturers simply unloaded it at the delivery docks of the plant.

Useful life of weaving machines ranged from 30 to 40 years as the mechanical strain was not as high as in other industries. Sefar's oldest machines were up to

50 years old due to excellent maintenance procedures and running equipment at lower speeds than typical modern weaving looms.

Adopting New Materials and Entering New Applications

Beginning in flour sieving, abrasives sieving was added as a second application area, requiring precise fabric to obtain same-sized particles. In the early 1900s, screen printing was developed in the USA. The Swiss silk gauze manufacturers promoted this development realizing a new market for silk gauze. At first, silk gauze for flour sieving application was used. In 1924, a silk gauze trademarked “STENSILK,” made specifically for screen printing, was introduced. Screen printing soon became an important business area for Sefar.

When nylon was invented shortly before the WWII, Sefar started experimenting with synthetic fibers, developing new weaving techniques. In 1945, nylon yarn was for the first time woven into gauze on a mechanical loom. In 1950, after lengthy experiments, the company succeeded in producing nylon fabrics that were more effective and durable than silk products. In the 1960s, synthetic fibers increasingly replaced silk until, finally, in 1990, the production of silk bag cloth was discontinued. Synthetic fibers permitted the application of various chemical coatings, leading to finishing becoming an additional production step.

The adoption of synthetic fibers allowed for an expansion of application areas, with Sefar entering filtration applications for the automotive industry with fabric superior to metal filters. Undertaking considerable effort, Sefar managed to make filtration one of its most important business segments in the twenty-first century.

In 2005, on the occasion of its 175th anniversary, Sefar employment had reached 1600, achieving sales of more than CHF 300 mio, divided equally between its Printing and Filtration Divisions. However, with the rise of digital printing, Sefar recognized that the printing market would decline. Searching for new applications for its capabilities, Sefar expanded the filter component business creating a new business development function. By 2018, screen printing mesh accounted for less than a quarter of company sales. Fortunately, production capacities for screen printing applications could also be used for filtration applications.

Engaging in a New Wave of Internationalization

Starting in 1995, a significant expansion of the company’s own sales organization abroad took place with the establishment of subsidiaries and the takeover of independent representative companies.

The expansion of production abroad was driven by the objective to reduce the imbalance between country of production (Switzerland) and the countries where sales were generated. Most important steps were the construction in 1996 of a weaving plant in Kabinburi, Thailand, to meet increasing demand in Asia, followed in 2007 by the establishment of a new weaving plant in Romania. After the opening

the production sites in Thailand and Romania, remaining weaving sites in France were closed. In 2018, 40% of the fabric volume was produced abroad while Switzerland still accounted for a majority of Sefar's weaving capacity.

In 2018, Sefar generated only 2–3% of sales with Swiss customers while more than half of the cost base was Swiss-based. This glaring discrepancy had always been the case and became an increasing challenge with the Swiss currency's consistent appreciation since the 1970s, a trend that was continuing to this day.

Focusing on B2B Markets

From the outset, Sefar and its predecessor companies focused on technical fabrics for B2B markets. Sefar never sought to enter other, more “glamorous” segments, such as the apparel or fashion industries, focusing on industrial applications where its core competence of producing “highly precise holes” was essential to its customers' production processes, reducing interruptions and providing longer-lasting filters.

In addition to its production facilities in Switzerland, Romania, and Thailand, Sefar operated subsidiaries employing hundreds of technically skilled salespersons and owned fabrication centers in 26 countries covering all continents. Sefar's 26 subsidiaries performed the task of understanding how customers employed filtration processes and how Sefar might help.

They learned of customer needs by directly approaching and engaging them. Lists organized by country were drawn up, how strategic industries were to be targeted by the sales subsidiaries. As a result, most of Sefar's products and services had been developed in collaboration with customers or developed exclusively as a response to specific requests.

Strengthening Innovation

In 1995, Sefar initiated a strategic program to increase and refocus its innovation capacity. R&D staff worked in process engineering, either in the development of new solutions in answer to customer problems or, to a lesser extent, relating to the improvement of their own production processes. Close cooperation with sales teams existed, in order to understand and incorporate customer requirements and ideas. Project teams for innovation comprised staff from sales, process engineering, development, and production. According to CEO Christoph Tobler, the origin of any innovation was usually a customer problem. Sefar employees visited customers personally, analyzing their needs and exploring how an optimization could be achieved. The company aimed to provide customers with added value and not to develop something “into the blue.”

Sefar also started to actively search for new business opportunities based on its own capabilities of producing very fine, precise holes. Currently, four specialists worked on R&D projects not based on an express customer need. This group, named “New Business,” typically collaborated with external partners, such as universities

or companies in other industries. The business segment “Architecture,” although still quite small, had its origin in this initiative.

Attracting Human Resources

Because there were few weaving companies remaining in Switzerland, it had become difficult to find qualified weavers in recent decades, conveying apprenticeship programs particular importance to Sefar. The company also tried to retain qualified people by offering an attractive working environment, providing attractive monetary benefits, and personal appreciation of the employees. The current CEO, for example, made a point to communicate directly with employees, visiting them at their machine on the occasion of an anniversary. The international operations of Sefar also provided additional opportunities to staff. With a smile, Christoph Tobler noted, *Once you're in the company, you do not want to leave.*

Family-Owned vs. Family-Managed

Since the merger in 1995 reuniting SST, SSZ, and ZBF, the owner families, including the Dufour and the two Tobler families, were major shareholders of Sefar. Nine families owned from 3% to 20% of the shares. Each family had one representative on the board, irrespective of size of ownership stake, providing every family with the same level of information and insights into the activities of Sefar. Restrictions on transfers ensured that shares could only be sold among members of the nine families. Tradability of shares was ensured via an informal “stock exchange” operated by the bank. Selected members of top management could become shareholders, with shares returning to the founding families after death or upon leaving Sefar prior to retirement. In 2018, more than 90% of shares were family-owned.

Once or twice a year, an event was held for members of the owner families, to renew or establish personal contacts and to become motivated to develop an emotional relationship to the company. Through such events, younger family members could be prepared for the moment when they would one day inherit shares, carrying the *feu sacré* within them already, ensuring shareholder loyalty even without family members working directly for the company.

Family members wishing to become active in the company were required to have appropriate qualifications. Since 1977, Sefar was led by nonfamily CEOs. Christoph Tobler (1957) was the only member of a founding family playing an active role in top management in recent times. He was appointed CEO in 2005, after having earned an engineering degree as well as an MBA, having worked for McKinsey & Company, and a career at Sika, a Swiss company in the construction chemical industry. His great-grandfather, and namesake, had entered the company 150 years earlier. The board of directors was deliberately chaired by a nonfamily member. In

2017, one family member of the younger generation had started to work in Sefar as business manager.

Despite family ownership, Sefar behaved similar to a public company by applying Swiss GAAP FER accounting principles. Sefar was financed conservatively with zero net debt. According to Christoph Tobler, this allowed for a high degree of independence, operating freedom and flexibility. For example, it made the acquisition of distressed Nexis Fibers (today Monosuisse) possible during the financial crisis. In addition, Sefar maintained an attractive dividend for shareholders.

Sefar Group – Technical Fabrics for Industrial Applications











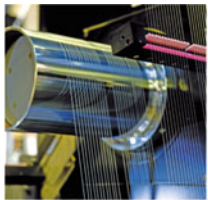

<p>Yarns & Fabrics</p> <p>From yarn production to precision fabrics and fabricated products for a wide variety of industries.</p>			
		<p>Process Filtration</p> <p>Broad selection of innovative solutions for solid/liquid filtration, screening and drying processes.</p>	
	<p>Filter Components</p> <p>Customer-specific solutions for filter applications in the automotive, acoustics, aerospace, appliance and healthcare industry.</p>		
			<p>Screen Printing</p> <p>Wide range of high-quality precision fabrics for screen printing and stretching equipment.</p>
<p>Architecture</p> <p>Creative architectural fabrics for light, acoustic, design and thermal effects.</p>			

Exhibit 26.1 Sefar product line

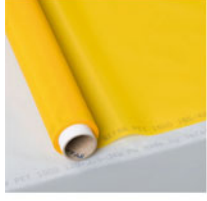
Company Profile 2: Burckhardt Compression³—World Leader in Gas Compression. Thriving Regardless of Multiple Ownership and Location Changes

From Small Workshop to Global Leader

On January 9, 2019, Burckhardt Compression celebrated its 175th anniversary by renaming the street in front of its Oberwinterthur offices to Franz-Burckhardt-Strasse. In the 175 years of its existence, the business had grown from a small workshop, producing engraving tools for the silk textile industry, into a company with CHF 594 mio in sales (2017) with a global workforce of 2200. Over its long history, the company endured three ownership changes, three name changes, and three location changes. Nevertheless, Burckhardt Compression became the world leader for demanding compression equipment relied on in many industries and processes, ranging from petrochemical processes to the oil & gas industry, marine applications, and refinery operations. Over the company's long history, it had weathered changes and became listed on the Swiss stock exchange in 2006, experiencing continuous growth ever since.

Starting a Small Workshop in Basel to Serve the Textile Industry

In 1844, Franz Burckhardt (1809–1882) acquired several properties at the Rümli river in Basel and founded a mechanical workshop. On this site, he manufactured rolling and engraving tools for silk ribbons for the textile industry flourishing at that time. Later, he expanded his range to produce milling machines, gas-powered machines, and bell frames. The business remained small, and major transformation took place when August Burckhardt, son of Franz, assumed control.

Shift Toward an Industrial Company and Focus on Compressors

When August Burckhardt (1851–1919) took over his father's company in 1876, he made several important changes. The company was turned into a partnership, Burckhardt & Co., and the business focus was redirected toward pumps and compressors with the first compressor sale recorded in 1883. In 1890, the business was restructured again, becoming a limited liability company trading as *Maschinenfabrik Burckhardt*. A patent was granted for its two-stage compressor. To accommodate the growing business, a new factory was built, and the old foundry business sold. Employment had reached 130.

³This profile was written by Jean-Pierre Jeannot (Professor Emeritus Babson College [USA] and IMD Institute [Switzerland]) on the basis of a company interview as well as based on publicly available information. Copyright©2019.

Burckhardt was able to develop a series of different compressor models that were both innovative and in high demand by industrial users. Over a period of about 50 years, the company launched compressors used in ammonia synthesis applications requiring very high-pressure levels. Burckhardt had always benefited from excellent in-house engineering talent that allowed the development of superior compression systems.

Burckhardt Becoming Member of Sulzer Group

When Burckhardt was acquired by the Sulzer Group in 1969, Burckhardt was still a family-owned company with sales of about CHF 70 mio and a worldwide staff of about 500 whose majority was working at its Basel site. Sulzer, a very large industrial group with sales of in excess of CHF 4 billion at that time, operated its own compressor business but lacked unique product lines such as Burckhardt's high-pressure and process gas reciprocating compressors.

Sulzer's involvement in reciprocating compressors dated back to 1935 when Sulzer had launched its first labyrinth-type compressor becoming its trademark product for decades and referred to simply as "Laby." The Laby[®] was a vertical, in-line reciprocating compressor, with a simple and rugged compressor design, including two design features which made the Laby[®] unique. Its design was based on the principle that pistons were not entirely flush with cylinder walls, requiring to be machined with small gaps that allowed for the passing of "dirt" in gases and yet preventing contamination from the operating lubricating oil. Since the guiding rods were not flush with the cylinders, manufacturing required exacting precision in machining, something, so far, no competitor had been able to match. These machining skills had been honed, it was said, by Sulzer at SLM, its manufacturer of locomotives, in connection with machining guiding rods of older locomotives models.

This Labyrinth compressor was originally designed for the safe compression of CO₂. The first "Laby" was installed at a Zurich brewery that required complete absence of oil residue in the compression process. Continuous improvements and developments made Sulzer's Laby[®] one of the most reliable compressor solutions for numerous applications handling complex gases such as bone-dry gases, humid gases, dirty, dust-laden, or contaminated gases in fouling services, as well as for clean gases where no contamination of the gas was allowed, and even for reactive, explosive, corrosive, or toxic gases.

Sulzer Group saw considerable industrial logic in combining the high-pressure and process gas reciprocating compressor line of Burckhardt with its Laby[®] model into one single company. In 1982, the piston compressor activities of Sulzer in Winterthur and Burckhardt in Basel were combined into a single business unit renamed Sulzer-Burckhardt Engineering. All business and production activities were consolidated into a new site in Oberwinterthur in 2000, with the old plant in Basel sold.

Industrial gas suppliers, polyolefin producers, process licensees, gas liquefaction systems, and many producers of chemicals relied on Burckhardt compressors and depended on the unsurpassed reliability of its equipment. Some 9000 compressors were installed, with 5500 still operating to this day, the oldest at a BASF plant dating back to 1942.

Grabbing Opportunity for Leaving Sulzer Group MBO

In 2000, a pivotal time for the Sulzer Group of companies, Valentin Vogt was appointed to head the Sulzer-Burckhardt business. Sulzer-Burckhardt had grown to CHF 120 mio in sales (new installations CHF 70 mio and service CHF 50 mio) with 430 employees worldwide, 330 of them in Winterthur.

During this period, Sulzer Group was undergoing substantial reorganization and wanted to focus on four business areas only. Sulzer-Burckhardt and three other business areas were put up for sale. Among those, Sulzer-Burckhardt was the smallest one prompting the large company to conclude that this business was too small and the opportunities not large enough to keep it in the Sulzer portfolio.

Vogt quickly realized that the business was underperforming for a business with a healthy combination of new compressors sales and service, an EBIT of 10% should be possible, he thought. Among other reasons, corporate structures kept the business from flourishing, so when the business was put up for sale, Vogt convinced his management team that they should take this business private in a management buyout (MBO). Sulzer Corporate management at first declined to entertain the thought, but the company's board of directors gave the team 6 months to finalize a deal before they would sell the business elsewhere.

Vogt and his team concluded a deal with a private equity firm, Zurmont, who acquired 78% of the shares in the process. The management team kicked in 20% of the equity and made a deal with Sulzer to acquire the business for CHF 54 million. Vogt was convinced that, once out of the corporate umbrella, where *every management hierarchy costs 2–3% in EBIT*, they would be able to manage on their own far better than being part of a large corporation. As part of the move to separate from the Sulzer Group, the company name was changed to Burckhardt Compression.

Vogt attributed his own entrepreneurial bent to his roots in Vorderthal, a mountain valley in the canton of Schwyz, the place of origin of a number of Swiss business families. Raised in a family of entrepreneurs with his grandparents owning a sawmill, and his father owner of a textile company, Vogt was directed by family friends to study business rather than engineering. Graduating from the University of St Gallen (HSG) in controlling, he joined the controller staff of Sulzer Group on the recommendation of one of his professors. Vogt was soon sent as controller to a Sulzer US subsidiary active in surface technology where he was the only head office representative. After 4 years, he returned to Sulzer in Winterthur to be next sent to Wohlen (AG) where Sulzer had acquired a production company for equipment used in surface technology. There, Vogt rose from controller to head of systems

technology. Prior to his appointment as CEO of Sulzer-Burckhardt, Vogt had no exposure to the compressor business.

Tackling the Global Market for Compression

The installed base of high-performance compressors was estimated to at about 75,000 installations globally. Burckhardt's worldwide installed base amounted to about 5500 operating compressors: 300 hyper compressors reaching highest performance in terms of pressure, as well as about 4700 labyrinth compressors and 500 process gas compressors, all made by Burckhardt and Sulzer. In addition, some 70,000 process gas compressors were in use made by Burckhardt competitors, mostly large international firms such as Dresser Industries in the USA.

Burckhardt did not really compete in the process gas compressor market. Vogt convinced his team to move into this lower segment that was very large and could be considered a must-win segment for Burckhardt. Entering this segment meant also to sell to new user segments, such as into oil and gas, refinery, and the chemical sectors. Burckhardt could leverage its oil-free technology and the vibration-reducing models it offered.

Vogt described his role in driving this process as *dreaming of machines, morning, nights, and day* and as *walking around the world with piston eyes looking for new applications*. He experienced that new ideas were always out there and that one had to constantly be on the lookout for new opportunities.

Going for IPO

Four years into the MBO arrangement, the private equity firm Zurmont was itching for an exit. The acquisition of originally CHF 54 mio had reached a valuation of CHF 280 mio by their own account. Under those circumstances, several options were evaluated: Alternatives included finding another private equity firm to take over Zurmont's stake, approaching another larger compressor company as a strategic buyer, approaching a private investor, and, finally, do an IPO on the Swiss stock exchange.

Vogt and his team decided on an IPO, because the financial situation of the company was sound and the fact the private equity firm wanted to sell its entire stake of 78%, an amount difficult for a private investor to raise. The IPO was completed in 2006. For the year 2006, combined sales had risen to about CHF 400 mio, 75% of which came from new compressors, and the operating EBIT had reached CHF 55 mio. The IPO resulted in a market capitalization of close to CHF 280 mio. In later years, this amount was to reach and surpass CHF 1 billion.

Enlarging the Product Portfolio

Although Burckhardt added new models to the portfolio, the company stayed true to its focus on oscillating compressor technology and staying clear of the larger product segment of rotating compressors. The world's largest and highest performing compressor was installed by Burckhardt in 2007. This was followed by a new design for the Laby-GI for dual-fuel stroke engines for large LNG tankers used for direct injection of boil-off gas into the diesel engines of the tankers.

By 2017, sales for new machines had reached CHF 350 mio, of which CHF 100 mio was due to new applications in connection with LNG tankers. This sales growth also had an impact on Burckhardt's ranking among compressor builders. While part of the Sulzer Group, Burckhardt ranked a distant fourth behind the larger Dresser, GE, and Neumann Esser of Germany. With sales expansion and continued market success, Burckhardt Compression rose to the No. 1 position in new machines.

Growing the Manufacturing Footprint

By the end of WWII, employment at the Burckhardt factory in Basel factory and other locations topped 500 and that number stayed constant until the business was merged into the Sulzer Group. This merger brought about the consolidation of all manufacturing activities in Oberwinterthur where employment amounted to about 330 persons at the time of the MBO with another 100 in international operations abroad. About 80% of all manufacturing took place in Oberwinterthur.

As the Sulzer Group was reorganizing, Burckhardt was able to acquire the Sulzer Group compressor business in India in 2005. Three additional assembly facilities were opened in Korea in 2015 in the vicinity of the shipbuilding cluster, as well as in Waller, Texas for the assembly of compressors destined for the North American market for customers for whom local assembly was important. The US plant sourced the critical components from Switzerland and the rest, about two-thirds, from US suppliers.

Finally, by acquiring the leading Chinese piston compressor manufacturer, Burckhardt gained access to the Chinese local market as well as an assembly location for its own compressors and as a sourcing point for components to be used in its Swiss and US assembly plants. Started earlier by a Chinese entrepreneur who had reached retirement, this business brought CHF 100 mio in sales and a workforce of 600.

Enlarging the Service Footprint

Over the company history, some 9000 Burckhardt and Sulzer branded compressors had been installed. Of those, some 5500 were still operating, with Burckhardt performing its own service on about 4500. This service business had grown fourfold

from CHF 50 mio in 2000 to CHF 200 mio in 2016 and was an important contributor to profitability with margins and returns on average two to three times higher than for the manufacturing of new installation business.

Many of the Burckhardt compressors were deployed in processes where reliable performance was mission-critical, particularly those installed in petrochemical crackers. Burckhardt maintained clear standards for its service business: Phone calls had to be returned within hours, a service engineer had to be on location within 24 h, and any repairs had to be carried out in a matter of a few days. Since 2004, Burckhardt had the capacity to digitally monitor newly installed units.

With the expansion of both the manufacturing and service footprint, in combination with a sales growth by a factor of almost 6 compared to the year 2000, the workforce composition had changed as well. At the outset, 75% of the workforce of about 500 were located in Switzerland, but by 2017 the ratio had changed to 1/3 located in Switzerland out of a total of 2100. However, the Swiss workforce more than doubled to about 700 over that period of time. Some global customers, such as Shell or Dow, were accepting Swiss assembled compressors only.

The Sales Footprint Centered on Switzerland

New machine sales, although global in nature, operated from the Swiss base. The sales process was highly technical in nature and required considerable know-how regarding the various processes and their requisite installations. The center of competence for sale was thus maintained in Switzerland, with a few sales experts stationed in the USA and China. The footprint and organization of the service business were different and more decentralized.

Maintaining Financial Flexibility

Burckhardt management believed that operating as a public company listed on the Swiss stock exchange offered some important advantages. Although the free cash flow of CHF 30 to 40 mio allowed the company to finance its investments internally, including the India and China acquisitions, there were always situations where access to the stock market would allow raising capital beyond the own cash flow generation. Such a situation did indeed arise, and the necessary financing could be arranged in a few weeks, but in the end the company decided not to go through with the deal under consideration. Burckhardt Compression's stable profitability and cash flow allowed for a dividend payout ratio of 50% or more.

As a public company subject to more scrutiny, dealing with changes in the economy also required a different response time. During the financial crisis of 2008/2009 when orders for major equipment sharply declined, being a public company management felt forced to react right away by reducing costs. *A private company might have been able to ride out the storm and wait for the economy to come back* (Vogt).

Management Principles Driving Burckhardt Compression

Vogt, Chairman and its first CEO, was a strong believer in smaller, manageable units. When he took over management of Sulzer-Burckhardt, he recalled *there were about 400 people working in the Oberwinterthur location and I knew everyone by name. When organizational units pass 1500 staff, they become slow and lazy, and one starts to hire people who keep others from being productive* (Vogt).

Vogt became intrigued by the behavior of an independent church in the Winterthur area where church leadership kept the congregations at about 1000 and, when they grew, simply created another congregation to start all over again. With more than 1000 church members, everything became too anonymous, and applying the “Beehive Principle,” the church moved to another location in the region creating a new cluster.

With Burckhardt surpassing 2000 employees, Vogt was eager to create his own “beehive” experience. The company divided its operations into two distinct parts, one for new machine systems and one for service business, since both operated under different key success factors. Vogt likened this organizational move to operating two frigates instead of a single aircraft carrier. Each unit had its own management team, was endowed with autonomy, and led by a smallholding group of only 11 executives and staff. *Synergies rarely exist, and they are consistently overvalued by managers*, observed Vogt.

Governance at Burckhardt Compression

With 78% of the shares now on free float on the Swiss stock exchange, governance of the company had to reflect requirements of the investor community and stock market regulations. Outside investors were attracted by Swiss companies who maintained a sharp focus in their business and whose business model was clearly articulated. *Particularly US investors like the clear and single-minded business purpose of a company such as Burckhardt Compression.*

Stability in ownership was maintained through a binding contract among the five founding shareholders controlling about 18% of shares following the IPO. Vogt, Chairman of the Board, believed that a public company always required a set of core investors who were committed for the long term.

Reciprocating Compressors – Product Range

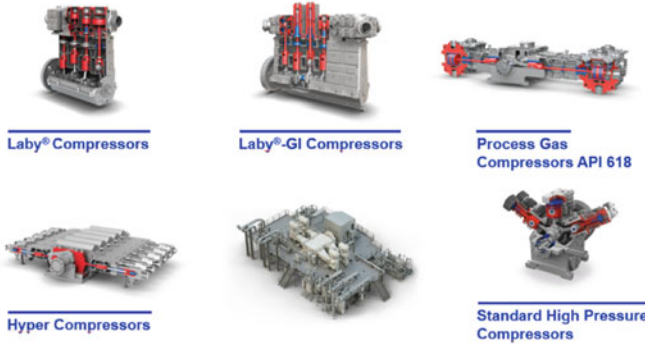

Laby® Compressors

Laby®-GI Compressors

Process Gas Compressors API 618

Hyper Compressors

Standard High Pressure Compressors

Process Gas Compressor

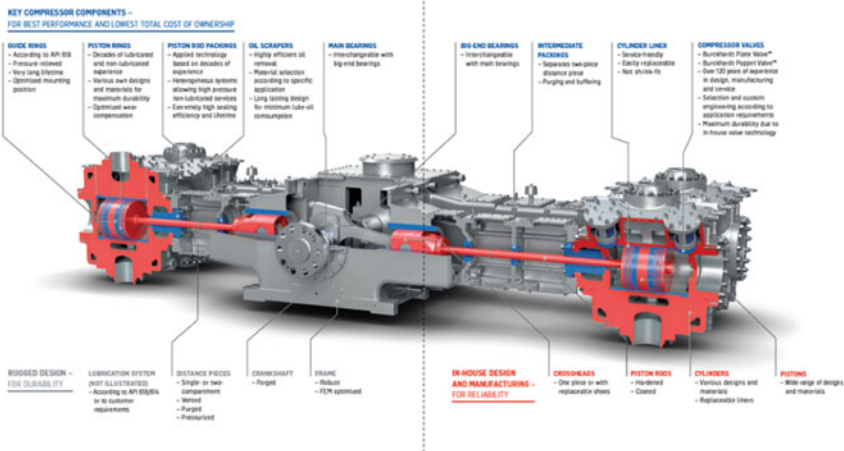

Exhibit 26.2 Burckhardt compression product line

Company Profile 3: Geistlich Pharma AG⁴—Global Leader in Regenerative Dentistry. From Production of Glue to Bone Regeneration over More than 100 Years

From Industrial Glue to Bone Regeneration

The company founded by Heinrich Geistlich in 1851 near Zurich completely transformed itself over the period of more than 100 years to move from processing of slaughterhouse remains into a pharma and biotech company that capitalized on the skills accumulated in its early history to become the global leader for regenerative dentistry. Still owned by descendants of the Geistlich family and its founders, the private company had more than 700 employees worldwide, operated from two sites in Switzerland, and positioned itself as the regeneration company with annual sales estimated at surpassing CHF 200 mio.⁵ Throughout this long history, processing animal bones and tissue remained the core competency of Geistlich. Geistlich Group, a holding company, included a number of operations with Geistlich Pharma AG its principle unit.

Beginning with Bone Processing

Heinrich Geistlich, the company founder, began his family company in 1851 in Zurich Riesbach, collecting animal bones and skins from slaughterhouses in the region to transform them into glue and adhesives. Growth of the business, as well as complaints of nearby residents concerning the smells emitted, required more space, and in 1873, the company moved to a new site in Schlieren on the western edge of Zurich. Schlieren, at that time, was a small farm village with plenty of space for a developing industrial enterprise. The move allowed the company to considerably expand its industrial processing operation.

Eduard Geistlich, son of the founder, in 1899 was able to acquire a second industrial site in Wolhusen (LU) near Lucerne which became the basis for a second processing factory. Eduard's sons in 1909 transformed the growing company into a shareholding company with shares owned by Geistlich family members and descendants. Throughout this entire period, and over several generations of Geistlich owners, the company collected animal remains from slaughterhouses in the region to convert them into adhesives and fertilizer, and eventually gelatin, which was largely produced on the Wolhusen site.

⁴This profile was written by Jean-Pierre Jeannet (Professor Emeritus Babson College [USA] and IMD [Switzerland]) on the basis of a company interview as well as publicly available information. Copyright©2019.

⁵As a privately owned company, Geistlich Pharma did not report any financial figures. Estimates were averaged from sources of several news organizations.

Taking First Steps into Pharma Space

In the midst of WWII, Geistlich continued to develop new products and processes. The company's expertise in producing natural glue and fertilizer became the basis for developing Decalcit, a nutritional calcium supplement for bone growth, introduced in 1943. In 1950, Geistlich extended its product range with Kelosoft, a henbane plant-derived product against skin scarring, and Taurolin, a product against infections. These products were marketed together with its gelatin brands for skin, hair, and nail care. Gelatin products were derived from animal tissue, a process the company had perfected over many decades. Many of these products and brands were in production to this date. It was in the 1950s that Geistlich invested in GEWO in Germany, a contract filler of pharmaceutical and cosmetics products.

The move into medical products received an additional push in 1954, with the entry of Dr. Peter Geistlich into the company. He had earned his PhD in chemical engineering from ETH Zurich, at a time when the Geistlich company produced adhesives, fertilizers, and gelatin by the tons. Peter Geistlich started in the pharma department and soon began to develop new products. In 1959, he obtained his first patent for an agent against tuberculosis. Over his long career at the company, he was to amass more than 140 patents. With Peter Geistlich at the helm, the company entered the cosmetics and wellness segments.

Entering Regenerative Biomaterials

In the early 1980s, Peter Geistlich, an avid reader of scientific journals, came across an article in a US journal about synthetic bone materials being used for regeneration in dental surgery. At the time, bone replacement or enhancements involved bone grafts from the patient and required a highly complex procedure. It was essential for patients with insufficient bone mass left in their jaws for successful dental surgery. One of the leading experts in this field was Professor Boyne from California. Peter Geistlich was immediately attracted to the ideas behind the article. He established a collaboration and engaged in joint research with Boyne and determined that bone augmentation for dental surgery could be achieved using natural bone materials.

These insights and exchanges led to research on the basis of bones processed in still large amounts in the Wolhusen plant. Peter Geistlich, who assumed the role of Chairman of the Board in 1974, took the pharma part of Geistlich into an entirely new direction. He was described as a chemist and scientist with very smart product ideas, but not in the classical pharma mold. In 1986, Geistlich Bio-Oss[®] was launched to enhance jawbone structures for dental patients, thus enabling implants that were previously impossible. Thousands of dental procedures were carried out resulting in Geistlich assuming the leadership in regenerative dentistry.

After the successful entry into the dental regeneration market, Geistlich launched Orthoss[®], a bone regeneration material for orthopedic bone defects. This was followed in 1996 by Bio-Gide[®], an absorbable collagen membrane for dental surgery, and Chondro-Gide[®], a collagen material for cartilage defects. Bio-Gide[®]

was a natural bilayer collagen membrane superseding nonresorbable membranes, simplifying surgical techniques, and effectively revolutionizing bone regeneration. By 2004, only about 15 years after introduction, Geistlich's Bio-Oss[®] had become the most often used bone replacement material in oral and maxillofacial surgery. A Geistlich product was used every 18 s somewhere in the world.

Shedding Legacy Businesses

Parallel to the rapid success of the new bone regeneration products, Geistlich experienced a steady deterioration of its traditional business of producing adhesives and gelatin products. The company faced a crisis in 1992 when the traditional businesses went into decline and the new business into bone fortification had not yet hit its stride. It was reported that Peter Geistlich sold private real estate in the region to ensure continued salary payments to employees.

The final blow to the legacy businesses was delivered when the long-lasting gelatin cartel was disallowed and the monopoly the company had enjoyed in collecting animal bones from slaughterhouses was abolished.

With limited prospects for growth in its core business, the company had acquired a cosmetics contract filler (GEWO) in Germany in 1950, and Delta in Zofingen in 1951, active in the cleaning supply and systems business, each employing about 50 persons. Although both businesses operated successfully, they could not make up for the steady decline in the core business.

By 2002, the legacy operations had ceased, and the only production maintained was the bio and pharmaceutical operations at the Wolhusen site. The adhesive business was also divested, requiring a reorganization of the company around a holding structure.

The holding company created owned the four operating businesses of Geistlich: Pharma, GEWO, Delta, and Geistlich Real Estate. The latter managed a large real estate portfolio with the former Geistlich operation in Schlieren, located on a prime site next to the railway station, with almost 80,000 m² as the largest part of the portfolio. This location, once a greenfield plant outside the small Schlieren village, had since been surrounded by commercial and residential construction, and had become a prime real estate parcel on the outskirts of Zurich. An extensive real estate development was now underway, resulting in the construction of hundreds of apartments and space for businesses.

The Wolhusen site was expanded with the purchase of an adjacent lot allowing for further expansion of the bone regeneration business. An administrative center was opened in Lucerne-Root for Geistlich Pharma.

Shifting from an Industrial to a Biomaterials Enterprise

The process of shifting production from the traditional industrial processing of animal bones and tissues to biomaterials began in the mid-1980s and was completed by 2001. This required a fundamental change in operations that people living in the

vicinity of the Schlieren and Wolhusen plants noticed soon when the persistent strong odor emitted from the plants suddenly vanished. Gone were the trucks and railcars delivering bones by the tons and truckloads. Instead, the company now delivered its products in small doses, typically one gram for a single surgical procedure. One kilogram of the new materials was reported to cost CHF 200,000. Instead of tons of industrial materials, the company's annual shipments of biomaterials amounted to a few hundred kilograms.

The production processes for a biomaterials company differed radically from the previous industrial production model. Careful selection of bovine bones was required, and bones or collagen was sourced exclusively from monitored establishments. Rigorous cleaning and purification processes were installed. All production processes were subject to regular inspections by various independent institutions and government authorities. End products were subjected to meticulous sterilization in sterile pressure chambers, used not only for manufacturing but also for packaging. All products also underwent individual manual quality control in the Swiss plant. This clean room environment differed radically from the environment of the old bone processing plants.

The Geistlich manufacturing process established for the purpose of entering into biomaterials was enhanced through a complete in-house integration of all-important process steps and buttressed by the accumulation of a large number of patents that were granted on its original products. The combination of these features made it very difficult for potential competitors to enter this space and was a prime reason why Geistlich could achieve dominance in this field.

Adapting the Business Model to New Realities

In line with the new orientation of the company, a completely different business model was required. Geistlich Pharma customers now were dental surgeons located all over the world, radically different from industrial users of adhesives located mainly in Switzerland. In order to reach dental surgeons, the company put its emphasis on direct sales, educational courses, and participation in dental congresses, thus conducting its business without a formal sales force. Surgical procedures could be demonstrated in the context of those congresses.

To support the educational effort that went into communicating the use of biomaterials for bone enhancement, the Osteology Foundation was created in 2003. A second foundation, the Osteo Science Foundation, was established in 2013 and also supported by Geistlich. The Geistlich efforts did not only help the sale of its products, but in a large way contributed to the growth of use of regenerative bone materials globally. Geistlich dominated this niche that the company had a major role in creating in the first place.

In addition, subsidiary companies were built in key markets. With 95% of production exported to some 90 countries, the role of these companies was to provide distribution to the well-defined target market of dental surgeons. Ten such companies were set up in Germany (1960), the UK (1950s), Italy (2003), France

(2008), China (2008), India (2016), Australia and New Zealand (2014), South Korea (2011), USA (2012), and Brazil. The subsidiaries' role in the markets was to assist with the marketing of Geistlich products, to help conduct clinical studies and to train and educate local medical professionals in the use of Geistlich products.

With research becoming fundamental to the development of Geistlich biomaterials, the company established and maintained a large network of scientists across more than 100 universities spread all over the world. More than 1000 scientific and research articles had been published that dealt with the experience of using biomaterials for dental surgery and bone enhancement. The company also maintained a highly skilled group of in-house experts in the field of bone regeneration and collagen use, prompting some in the field to refer to Geistlich as the "Tissue Engineers."

Geistlich was not the only company active in the dental surgery and implant market. Geistlich did not market the dental implants themselves, but left this to the larger implant producers, such as Straumann or Nobel. Dentists had to use Geistlich products in circumstances involving a lack of bone substance. Although closely related to implant manufacturers due to marketing to the same customer group, Geistlich pursued a clear policy of maintaining equidistance to all implant producers, guarding its independence and "neutrality."

Segmenting Pharma into Business Units

As the bone regeneration product lines began to expand, Geistlich Pharma was divided into three business units (BU) focusing on distinct segments.

The Dental BU addressed a number of therapeutic areas that centered around bone augmentation, major and minor, and tissue regeneration. The product line included Geistlich Bio-Oss[®], Bio-Oss Pen[®], and Bio-Oss[®] Collagen, some offered in various combination kits and packs.

The Orthopedic BU addressed the therapeutic area of bone regeneration with the bone substitute Orthoss[®] and cartilage regeneration with the products Chondro-Gide[®].

The third BU, Medical, included a number of pharma OTC products dealing with infectiology, wound care, dermatology, and the dietary supplements that had been part of the Geistlich company product line for decades.

Albeit the heavy emphasis on bone regeneration, the company sometimes positioned itself simply as the Regeneration Company, since its other products also belong to this context. Both the dental and orthopedic BUs could be seen as platforms suited to add further products to the portfolio, all of them based on the same technology.

Managing Geistlich

Geistlich operating units were part of the holding company and managed by professional management teams. Geistlich Pharma, who had its own board, was headed by a professional team of nonfamily members with expertise in the biotechnology field. Internal reporting followed IFRS standards even though the company was privately owned and not public or stock market listed. All management tools of larger public companies, including audit tools, were employed. Tracking performance on the basis of IFRS provided transparency for all stakeholders. Regular, monthly meetings took place to brief company ownership on progress of the business. Geistlich pharma management pursued a strategy of vertical integration and independence of any implant makers.

Strong brands, backed up with R&D and educational programs for medical professionals, create a strong business model allowing world price levels that can support the higher cost base of Switzerland (Paul Note, CEO Geistlich Pharma).

Governance at Geistlich

Over its entire history, Geistlich remained a private company owned by Geistlich family members and their descendants. The Geistlich shareholding group comprised about 40 family members with a shareholder agreement in place. The group met for a general assembly once per year. Since the retirement of Peter Geistlich, there had been no Geistlich family member active in operational management. Both boards, for the holding company and for Geistlich Pharma, included Geistlich family members with the present chairman, Andreas Geistlich, nephew of Dr. Peter Geistlich (1927–2014), the prime mover of the company into the bio regeneration field. The company owners were committed to a strategy of independence.



Exhibit 26.3 Geistlich pharma product line

Company Profile 4: Sécheron Hasler Group⁶—World Champion in DC Electrical Trains. Electric Power Systems for Traction and Energy

A Storied History in Traction Power and Energy

Few companies could compare with the rich and varied history of Sécheron. Over its 140-year existence, Sécheron had undergone numerous transformations, was acquired multiple times, divided and spun out more than once, seen volume and employment grow and then decline, and yet survived all of this to reclaim its position as a world-class supplier of power safety systems, whether for rolling stock or energy generation. Operating from Geneva, where the company had been located from the very beginning, and Bern, Sécheron Hasler Group, its corporate name today, employed a global workforce of more than 1100 and reported sales of CHF 270 mio (2017). If any company deserved the title “Come-Back Kid,” this was the

⁶This case was written by Jean-Pierre Jeannet (Professor Emeritus Babson College [USA] and IMD [Switzerland]) on the basis of a company interview as well as from publicly available information. Copyright©2019.

one. The main recognition, however, is earned by the ownership group that transformed the company over the past decade.

Surviving the First 90 Years

The early history of Sécheron was closely tied to a few Geneva engineers and entrepreneurs who moved the company site and changed its name several times and evolved its product line. From its start in 1879, the company had been identified with electric equipment and appliances. Alfred de Meuron was an early shaper of the company, as was Hermann Cuénod and René Thury, the latter a technical genius behind many of the first inventions. Around 1884, engineer Thury acquired an international reputation for strong dynamos, rack traction for steep slopes, and long-distance power generation.

The company exported its electric motors and generators to many countries. By the time the name was changed to Cuénod, Sautter & Cie in 1887, its reputation in the field of power generation and equipment for electrical tramways had also grown. It was around 1899 when the company for the first time missed a market change, from direct current to alternating current, and as a result hit a difficult patch financially.

Two name changes later, the company adopted the name S.A. des Ateliers de Sécheron in 1918 and became involved in the electrification of the Swiss Federal Railway network. Sécheron expanded into the production of alternators, transformers, and the electric traction of rolling stock of all kinds. Based on its research, the company entered arc welding as part of its production processes. The Swiss electric equipment maker Brown Boveri (BBC) acquired the majority stake in the firm, only to sell it a few years later. The following decade ended with the introduction of mercury vapor rectifiers for use in many traction applications, but also rolling mills and DC networks. Rectifiers for DC power substations followed in 1937, and first DC circuit breakers in 1948. During the post-WWII period, Sécheron experienced healthy growth, was profitable, and by 1963 reached employment of 1700 and sales of CHF 55 mio. By 1965, new order take-in began to decline, mainly because Sécheron was not able to accept new orders with very short delivery time. Difficulties prompted the company to engage in merger talks with several suitors, both Swiss and foreign.

Brown Boveri (BBC) Acquired Sécheron in 1969

Brown Boveri & Cie (BBC) was the leading electrical equipment and power generation producer in Switzerland and itself a large international company. By that time, employment at Sécheron declined to 1250. By all accounts, the integration of the two companies was fraught with difficulties, but possibly saved the survival of Sécheron as an entity. Under BBC, Sécheron could profit from orders for Swiss

locomotives. Sales by 1979 reached CHF 120 mio, and employment was at 1200, including some 130 engineers.

The merger of Sécheron's parent company, Brown Boveri, into ABB (Asea Brown Boveri) in 1988 brought substantial changes for Sécheron and a radical restructuring by separating the businesses into two companies. The now renamed ABB-Sécheron took the largest part, the transformer business, leaving Sécheron SA with the DC traction components and the DC traction power substations.

Regaining Independence Through Spin-Off 1990

ABB Group, new owners of Sécheron through the merger with BBC, did not hold on to the activities and product lines of power supply substations and traction components. ABB sold 80% of the shares of this business to a Geneva Holding company, Noga Industries, controlled by Nessim Gaon, who had a financial but no industrial or technological background relevant to the Sécheron business.

At the time of the spin-off in 1989, Sécheron was down to just 180 people and sales of about CHF 25 mio. Driven toward a rapid expansion strategy, Sécheron engaged in a number of acquisitions and joint ventures in Germany, Czech Republic, India, and China, as well as the absorption of Hasler for in-train electronics, growing to a combined sales volume of 120 million. The expansion came at the cost of profitability, eventually leading to losses. On the positive side, Sécheron became again recognized as a leading component supplier for major firms such as Siemens, GEC-Alsthom, and Japanese companies.

Bankers to the Rescue

In 1995, Geneva bank BCGE stepped in to assume control of the company. By 1996, when Sécheron reached a high point in terms of sales of CHF 120 mio, the company was still relying on about 80% on products and components over 10 years old. New developments were in the pipeline, but they still needed technical completion before commercialization could be considered. Pressure was building from railway operators as many of them were undergoing privatization, putting pressure on component suppliers in turn.

As a first major step toward improvement, in 1999 the company acquired full ownership of its Czech JV whose CHF 20 mio in sales came largely from the transfer of older products from the Geneva operation, to create Sécheron Tchèque. In 2000, the retrenchment led to a workforce reduction in Switzerland. By 2004, Sécheron sales were CHF 100 mio, about the same level as 10 years ago, and the global workforce was about 500, with about half of them in Switzerland.

With the situation still not improving, BCGE was looking for new owners. There were several international companies in the field of railway or energy interested, but the Geneva bank and the responsible manager favored a Swiss ownership solution.

Transition Partners Taking Ownership in 2005

A group of six private Swiss investors joined together and were able to acquire Sécheron from the bank.⁷ The partners did not see themselves as a private equity group in the traditional sense, instead they were actively involved in the business and had no plans to sell. The company remained privately owned, and no IPO was planned. Some of these investors had worked together on other transformation projects, in particular under Ernst Thomke, and gained valuable management experience in how to turn around an industrial enterprise. They also possessed deep technical know-how in many areas relevant for Sécheron and by investing their own money, the new owners all had *skin in the game* (Lombardini).

The investor team reviewed Sécheron's business and was attracted by its established good name in the industry. Although the company ran scarcely at a profit at the time of the investment, the investors noted the long heritage of Sécheron in the sector going back decades and considered the market outlook to remain solid. The company had been privately owned, lacked solid reporting systems, and was poorly managed. Clearly, at this time, Sécheron was not "best in class."

The acquisition was heavily leveraged with financing provided through BEKB and BCGE requiring a minimum of investor capital. The top 15 managers of the company were invited 1 year later to participate in the acquisition with all but one participating. As it turned out, the entire external financing was paid back within 4 years. The name was changed to Sécheron Hasler Group as the Hasler name was still well known in the industry and the company wanted to have this reflected in the group's name.

Initiating a Turnaround Exercise

The investor team had learned the practice of turnaround management under Ernst Thomke, one of the investors: *First came the work on the cost structure of the company, proceeding step-by-step. Lowering costs, and as a result, increasing efficiency and continuous improvement on all levels became an obsession. Monthly flash reports on cash, liquidity, EBIT, etc. were instituted. We operated in a down-to-earth style, avoiding the approach of strategic intellectuals. Everything was measured and measured again* (Lombardini).

Organizationally, the new owners created the Sécheron Hasler Group while at the same time minimizing overhead, focusing on the three different segment organizations by giving them large autonomy, similar to three companies within the Group: two based at Sécheron in Geneva, namely the component and the systems business, and the third comprising the Hasler business located in Berne and focusing on onboard electronics.

⁷According to a press release from BCGE the investors were Martin Balters, Bernhard Flotron (†), Nils Hagander, Anton Kräulingen, Robert Lombardini, Guillaume Pictet, and Ernst Thomke.

Refocusing on Three Segments

The component business involved the design and manufacturing of standard and customized components as well as more complex subsystems, where the company integrated its own or third-party components into compact high-voltage enclosures convenient to supply and easy to install. These products and solutions served to protect electrical equipment in rolling stock and power substations as well as in energy-intensive industries and energy production.

Sécheron had a strong heritage in this sector but operated with a 30-year-old concept. This was a conservative market competing as a merchant supplier against large international firms, such as Knorr or GE, selling to OEMs, and at the same time playing the game of captive supplier to Sécheron's own systems business.

In the systems business, Sécheron had captured the position as the world's leading supplier of electrical equipment for DC traction substations with an installed base across many countries. Sécheron leveraged extensive knowledge of the technologies used in railway components through extensive in-house engineering capabilities. The company offered both standard and customized solutions and extended its market coverage to provide solutions for energy storage and recovery.

The new Sécheron owners considered at one time whether they should sell the systems business as it had been loss-making before the acquisition or to look for a joint venture. The company stayed with the business, deciding that the systems business was needed as a second leg of its strategy. To sustain the business, the company invested in new products and engineering.

Hasler Rail, the business for onboard electronics, was the smallest of the three businesses with only about CHF 20 mio in sales. The Hasler brand was well established with about 40,000 systems installed and operating worldwide, albeit comprising different technology generations. For more than 120 years, Hasler was the market leader for speed acquisition systems, for speed displays, and train data recorders. The market approach differed from the Sécheron business in that it required a different sales and distribution network.

Streamlining the Manufacturing Footprint

In line with the new ownership's reorganization, the manufacturing footprint of Sécheron was put in compliance with the new market dynamics. The Geneva site continued to be used for final assembly and testing of components, as well as research. This meant that customers took physical ownership of the final products in Geneva, allowing Sécheron to project the *Swiss Company* and *Swiss Made* image. The head count varied but ranged around 240–280. The smaller Hasler Rail operation had a local head count of about 75–100.

Major changes took place in the Czech operation in Prague. At the time of starting the turnaround in Geneva, the new owners realized that they had to instigate a turnaround in Prague as well. The operation there, formerly a site under communist control, need to be moved to a western performance culture with an infusion of

young people. The manufacturing in Prague dealt with pressed components, mechanical parts, and copper-based parts and was brought to a European level in terms of costs, even while currency values moved substantially. Starting out with a workforce of 230, the Prague operation first declined to about 170 and then grew back to 550 during a time when competition for talent was increasing as well.

Generating New Sales Dynamics

The Sécheron sales organization was in place prior to the ownership change in 2005. Some of the changes made since included the use of many family-owned distributors. The most important step was the JV with a family-owned company in China while maintaining a wholly owned sales company there at the same time. With sufficient competence on the market, sales into the entire South East Asia region picked up in dynamics. Today, Sécheron made more than 20% of sales in China. Sales offices were opened in Russia (2009), Italy (2014), Brazil (2015), India and the UK (2016), and in Germany (2017).

Two recent acquisitions added to the product range of the Sécheron Group: Saira Electronics, based in Italy, with an office in the USA, was partially acquired in 2016 adding 70 staff and CHF 20 mio in sales to the Sécheron Hasler Group. Saira was a pioneer in energy metering systems with a large installed base of its energy management suite, supporting customers with economical driving and invoicing. Acquiring the majority stake in Saira was also believed to secure the group a window in the emerging area of IoT. In 2018, Sécheron Hasler Group acquired Pixy, a company started in 1988 focusing on display systems for train drivers. More than 30,000 such systems were in use, both in Europe and Asia. The company operations in Turgi (AG) and in Shanghai were left unchanged.

Resourcing the Group

Sécheron Hasler Group was financing its own growth and investments from internal cash flow. As a result, the company did not see a need for going public. Sufficient resources were at hand to fund internal development, and a group of about 100 engineers in Geneva, and elsewhere, were developing and improving its product line. Sales had steadily grown since the private investor group took over in 2005, reaching CHF 270 mio and a workforce of 1100. As a private company, Sécheron Hasler Group did not divulge any profitability figures. After almost 15 years, the investor group that took over control and management had been able to establish Sécheron Hasler Group at a level of activity and sales as in the best of its times, with the exception of employment which was still high, but only one-third located in Switzerland.

Owner-Managed Governance at Sécheron Hasler Group

The company remained in ownership by the investor group that had taken over in 2005. One member, Martin Balters, served as the group's CEO through all the years since the takeover. He was the main driver behind the new corporate culture, efficient implementation, and a style of openly working together. A second group member, Robert Lombardini, served in the role of board chair, a position he had assumed in 2008 from the late Bernhard Flotron, the company's previous chairman and also a member of the original investor group.

Lombardini thought it important to emphasize the core management principles of Sécheron as it grew beyond the initial two companies into an industrial group:

For us, the SME management principles are important. We run every division as a separate SME. SME management means that everyone speaks to everyone, and everyone is involved in the operations of the company (Lombardini).

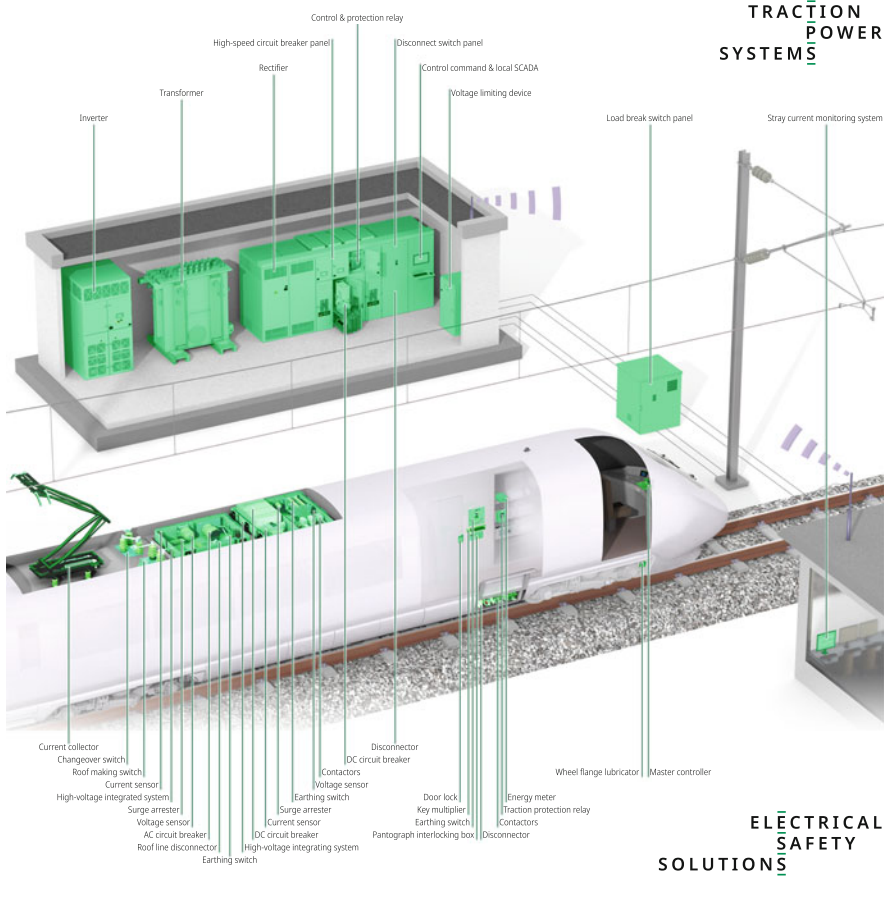

**TRACTION
POWER
SYSTEMS**

**ELECTRICAL
SAFETY
SOLUTIONS**

Data acquisition & recording
Speed sensing & odometry
Visualisation solutions & speed indicators

Energy metering
Control, protection & I/O
MVB based communication

Train backbone communication
EVA+ Rail Data Management
PDIY displays

**ON-
BOARD
ELECTRONICS**



DC high-speed circuit breaker breakers
UR10



AC high-speed circuit breaker breakers
MACS



IGBT & thyristor inverters
INV1 & INV1



High-speed circuit breaker panels
MBS



Data recording systems
TELOC 3000



Rail data management
EVA+ Energy portal



Contactors
BMS



High-voltage integrated systems
MODBOXe



Voltage limiting devices
VGUARD



Control & protection relays
SEPCOS



Energy meters
REM102



PDIY displays
INC-100

Exhibit 26.4 Sécheron product line

Company Profile 5: Cendres + Métaux (C+M) SA⁸—Global Specialist in Refining and Recycling of Precious Materials. From Supplying Materials to Micromechanical Competence

A Company Evolving Around Refining and Machining of Precious Metal

The company Cendres+Métaux (C+M) could look back to a storied history of more than 135 years. Starting as a small operation attached to a local pharmacy, the company gradually expanded its activities. Refining and processing gold followed by machining precious metal parts gave it an entry into the watch industry and, later on, into the dental and medical device industry. The company reached sales of about CHF 146 mio in 2019, spread internationally, and employed about 350 at its main operations in Biel/Bienne. The company had evolved into a specialized processor of precious metals and manufacturer of micromechanical high-quality and high precision components for the watch and medical device industry. Throughout, the company remained closely associated with the founding families although C + M had its shares listed on the regional trading platform OTC-X in Berne.

Beginning as a Refining Business Attached to a Pharmacy

In 1885, the local pharmacist Louis Aufranc, with business partner Jean Wendlich-Krebs, created a small precious metal smelter in the back of his store and began with the processing and smelting of precious metals scraps generated by the regional watch and jewelry industry. The scraps arose from the machining of precious metal parts, of gold and silver, for example, in the various manufacturing companies that had sprung up around the city of Biel/Bienne. Manufacturers collected the scraps, brought them to Aufranc for refining, and for later reuse.

A few years later, in 1894, the company was dissolved and Aufranc's son George-Louis, with Krebs still as partner, created Aufranc & Cie, assuming all assets and liabilities of the dissolved company. The company purpose now included trading in gold and silver ash as well. The purpose was changed again in 1907 with smelting as well as gold and silver waste trading stated as activities.

The company was turned into a limited enterprise in 1924 following the merger with a local business. It remained dedicated to the processing of scrap containing precious metals from the watch industry and from old jewelry with the aim of recycling. This focus is also expressed by the company name: *Cendres* is the French word for waste burnt to ashes, while *Métaux* is the French word for metals. Recycling precious metals remained the main purpose of the firm. Over time, the

⁸This profile was written by Jean-Pierre Jeannet (Professor Emeritus Babson College [USA] and IMD Institute [Switzerland]) on the basis of a company interview, as well as publicly available information. Copyright©2019.

processes were extended to alloys for the dental, medical, watch, jewelry, and other high precision industries.

The company's long history of recycling precious metals was noticeable to visitors of its premises until today. Upon leaving the manufacturing tract, a professional shoe cleaning installation invited departing visitors to a thorough cleaning, particularly of their shoe soles. The company indicated that over the course of a year, precious metal dust valued at several thousand Swiss Francs was collected and recycled through this practice.

Building a First Leg Serving the Watch and Jewelry Industry

Based on its recycling of precious metal waste from the watch industry, the company eventually produced an increasing number of watch components themselves. These were primarily produced on order for the luxury watch segment and included key components for a watch mechanism and case. Whenever a watch company needed a certain part in precious metal in their value chain, C+M would produce it on order. Over the years, the company amassed an extensive machine park of production machinery and testing equipment for the varied needs of its customers. Production processes employed state of the art machinery, ranging from CAD machining centers to robotics. These experiences led the company into micromechanics and to expand into production working metals other than gold and silver, such as stainless steel, platinum, and different types of precious metal alloys. Their expertise across a wide range of materials allowed C+M to acquire a profound material science competence.

As the business expanded, in 1961, the company moved to new production and administrative facilities on the eastern edge of Biel/Bienne where it had acquired a large tract of land behind the original pharmacy. A new refining plant was added for more environmentally friendly precious metal waste processing. By that time, C +M had 250 employees and produced some 10,000 different items sold to a large number of customers.

C+M had learned to master the entire precious metal cycle. Now and then, the services offered by C+M were complementary and began with the refining of precious metal. The recovered metals were melted down and cast into new alloys. From these alloys, various semi-finished products such as tubes, wires, or stamped parts were formed. Today, C + M also manufactured high-quality finished products for several industries. The company was specialized in oscillating weights, watch cases, and bracelet components for the watch industry.

C+M combines under one roof precious material technology, refining expertise, and precision machining of parts for many different industry applications and service options, far beyond what competitors offer (Philipp von Büren, CEO C +M Luxury+Industry).

C+M had organized itself around four main sectors, consisting of recycling precious metals, components for watches, jewelry, and the emerging dental sector which was becoming increasingly important to the firm.

Nurturing the Dental Market

C+M's heritage in precious metal recycling and micromechanics expertise had early on offered an entry into the dental market. In 1986, the company offered about 2000 products or items aimed at the dental market, such as dedicated alloys, attachments, and anchor systems. Sales of alloys and products went to dental technicians who created crowns, bridges, and other prostheses according to a dentist's specifications. The market for dental materials grew worldwide to about CHF 3 billion, about the same size as the market for dental implants.⁹

Since the 1950s until today, the company launched its own branded products and systems, such as Dalbo[®], Dolder[®], CM LOC[®], and Pekkton[®] ivory, a high-performance polymer developed as material of choice for metal-free dental prostheses, to serve its direct customers, the dental technicians.

Venturing into Contract Manufacturing

Besides selling directly to dental technicians, C+M increasingly became drawn into the role of a contract manufacturing organization (CMO) supplying leading dental implant manufacturers with additional components used in connection with implants. Owing to its expertise in processing and managing precious metal alloys on the one hand and its increasing mastery in manufacturing micromechanical parts, C+M was able to successfully enter this market. As CMO, C+M could and would combine the implant manufacturers' requirements with its own needs and perform outsourcing services, such as packaging and logistics for implant companies for products such as implants or abutments. Synergies and know-how could be used along all business areas and benefited all customers.

Contract manufacturing started initially with dental products only but grew into a business producing components for other medical products and implants, such as specialized parts for hearing aids, implants used in ophthalmology, and various other medical indications. With time, C+M gathered valuable experience with manufacturing critical parts and their surface treatment to prevent rejection by the human body.

Combined, the dental and medical product division grew to a significant part of C+M business. Due to its special mix of competencies, C+M became the leader in various market segments.

⁹Dental implants and prosthesis products differed in how they were inserted by dentists. Implants were anchored into the bone structure and required anesthesia-based surgery. Suppliers of implants were therefore different from those for materials for prosthesis. Prostheses were either caps, crowns, or bridges and were either inserted without the need for implants or placed on top of implants.

Innovative Excursions

During its long history, C+M always pursued challenging, innovative ideas. Depending on the result and strategic fit, these ideas and projects were integrated, sold or stopped.

The collaboration with the Insel Hospital Group in Berne was exemplary: Together with a team from the Insel, C+M researchers developed a bone-anchored port (BAP) for dialysis patients. This port, implanted in the patient's skull behind his ear, offered a sterile and permanent access that eliminated the lengthy procedure in hospitals to insert a new needle each time patients came in for dialysis. Initial tests with a few patients in the Berne hospital proved successful, and in addition, C+M gained valuable know-how.

Constantly Evolving C+M's Business Model

It is evident that the business model has changed over the years due to the addition of new businesses. However, to continually adapt and fine-tune the business model would be a challenge for any organization.

At the outset, C+M recycled precious metals for clients and resold the refined materials. This model was dominant for about the first 40 years of the company's history. As the company evolved, the recycling model remained important, but gradually lost its commanding position as other models were added.

However, the recycling of precious metal remained at the core of the enterprise. C+M was fully committed to its core competence with its new, state-of-the-art refining plant, which was opened in 2019. Refining services continued to be an essential part of the range of services offered to customers in both the watch industry as well as the medical field. To recycle precious metals in-house at C+M inspired great confidence among clients, since the origin of the materials could be controlled.

Starting in the first third of the 1900s, the company became involved, as a subcontractor for manufacturing components, in the watch industry, during the first 75 years of its history. It is still one of its main customers. This allowed C+M to accumulate thorough experience in various manufacturing steps. The subcontracting model expanded when C+M began taking over increasing responsibility for parts and modules, getting involved in design as the materials moved beyond gold and silver into titan, steel, and special precious metal alloys. For some customers, C+M also provided modules and assembly services, taking over an ever larger and ever more responsible role. This was particularly important for the many smaller customers who depended on the extensive expertise of C+M. In the end, manufacturing had eclipsed metal refining as the dominant activity.

Expansion into medical and dental markets brought about new tasks and challenges. Added to the material processing and manufacturing steps were the new requirements dictated by the dental and medical industries. Their quality requirements differed substantially from those of nonmedical customers in kind and stringency. Client composition changed, too, with dental technicians dominating

at first, but as the company became contract manufacturer and outsourcing partner, new client groups related to clean room services, packaging, and logistics emerged. Adopting the role of full partner to many medical and dental organizations, C+M also needed to adjust manufacturing running dedicated cells and processes for individual clients. At the end of this process was the emerging role of an integrated partner for a full range of products and services.

All of these new, emerging business models did not completely eliminate previous ones. Instead, the new ones were added on, and older models gradually moved to a less dominant role, as each new segment or business required its own business model.

Internationalizing C+M

Globally, C+M and its various businesses were active in more than 50 markets. With the operation in Biel/Bienne as sole manufacturing point, exports accounted for about 40% of sales and value created. The creation of international subsidiaries came relatively late and began with Italy (1961), followed by France/Paris (1970), and then followed the UK, and expansion into Asia with Korea and China (Shanghai) next.

These subsidiaries serviced the B2C sales channels and supplied branded products for dental laboratories and dentists. The CMO part of the organization was international by nature but managed and serviced from Biel/Bienne. The watch market was mainly a regional market, with a large industry cluster in the wider region around Biel/Bienne, home of C+M and major watch brands.

In essence, C+M was a processor of precious metals combined with mechanical processing of these very metals. From this original core competence, the various business models developed, enriched with new or complementary competences. On the one hand the metallurgical knowledge of precious metal alloys and on the other hand the expertise in mechanical processes evolved and, eventually, also included nonprecious metals. This, in turn, made it possible to enter completely new business areas.

C+M manages to transfer its core competence and knowledge across many different applications (Ronald J. Lenzeder, CEO Medtech).

In addition to materials research, a development department was established, which in turn enabled cooperation with creative users in the dental industry. The development competence paired with the technical manufacturing competence led to high-quality products sold under C+M's own name. The history of C+M was characterized throughout by concentration on its own strengths, further development of these same strengths, and their application in new business fields along the value chain of the core processes.

C+M technology know-how spans across many niche applications in a series of industries (Philipp von Büren, CEO C+M Luxury+Industry).

Using M&A to Expand C+M

Throughout its history, C+M used the acquisition of companies to add to its business. These companies were predominantly local or located in Western Switzerland. Acquisitions were driven by adding new technology skills and to further enlarge the value chain of C+M along its core competencies in the high-quality and precious metal area. The aim was to integrate them to the manufacturing site in Biel/Bienne. Employees of the acquired companies were offered jobs at C+M. In this way, C+M was able to offer *Swiss Made* and *Swiss quality* to customers in Switzerland and abroad.

Since the turn of the century, several acquisitions were concluded. In 2008, C+M acquired Galétan SA and Oscillor SA with its production site in La Chaux-de-Fonds and access to specific know-how in finished products along the value chain. In 2009, C+M acquired Metalor Dental AG with its B2B business and several subsidiaries. In 2016, C+M acquired the start-up company Momo Plus with its proprietary watch movement and was sold again in year 2019 as it did not fit into the company strategy and the core competence and focus of the company. In 2018, C+M acquired the 80-year-old and well-established watch case manufacturer Queloz SA in Saignelégier (JU) to further enlarge the value chain of C+M along its core competencies in the high-quality and precious metal area.

Time has shown that not all acquired businesses could be kept and some had to be divested, mostly because they did not fit adequately to the global strategy and focus of Cendres+Métaux.

Biel/Bienne, as a cluster of the Swiss watch industry, was an advantageous location for C+M. The company has always benefited from a broad network, healthy competition, and a unique talent pool.

Adapting Its Organizational Structure

Due to the addition of new customer groups, the organization was adjusted several times. The first major change came with the move from a single organization to four divisions, later expanded to five, to create individual units dedicated to the various industry segments of watchmaking and jewelry, industry, dental, medical, and smelting.

C+M's different products and services served very different customer segments, which were reflected in its managerial structure. All business areas were managed separately by dedicated department heads and teams. While the watch and CMO businesses were essentially B2B organizations, its customers are very different. On the other hand, the branded products were sold directly to dental technicians and dentist, but still reflecting a B2B business model.

In 2002, C+M changed its legal structure to form Cendres+Métaux Holding with all affiliated operating companies becoming subsidiaries of the holding company.

A major reorganization was started in 2015 when C+M regrouped its businesses into two major divisions. The watch and industry component businesses and the

refining business were combined into a single Luxury+Industry division. The dental, CMO, and medical businesses were combined into a single Medtech division. Since 2019, both companies acted individually as separate legal entities but belonging to the Cendres+Métaux Holding. The aim of the new organization was and is being able to better respond to the individual requirements of the highly different customer structures in order to guarantee the best service. C+M covered the customer needs of the watchmaking industry, the dental sector, and medical technology. At the same time, both companies were closely interwoven, making use of the strengths and expertise of the entire organization and belonging to a superordinate holding structure. Thus, the heterogeneous customer needs can be perfectly addressed, while at the same time, synergies within the company can be used.

Management and Governance

Founded as a partnership in 1885 and incorporated in 1924, the company had always been a shareholding company with a small set of shareholders at its core. Stock market research indicated that the company ownership included 30 larger and 280 smaller shareholders, with large shareholders collectively accounting for a controlling interest. Some of the earlier founding families were reported to still be part of the core shareholding group. C+M shares were listed on the trading platform OTC-X in Berne.

Sales reported by the company had declined from its high CHF 357 mio (2012) to its low CHF 123 mio (2017) primarily because of changes in the price of gold, changes in currency values, reduction in subsidiaries, and substitution in precious metal alloys in dental business.

The evolution of the underlying businesses and the changed market situations due to the shifts from the luxury segment toward medical and dental had also had an impact on board and management positions. Whereas the families remained active members of the board, on the operational side, senior management with specific industry know-how was engaged from outside of the company.

Today, the company was steered by two CEOs for each of the core divisions, who reported directly to the independent president of the board of directors. A rather flat hierarchy ensured fast decision-making processes, and with the independent board quality, corporate governance practice was secured.

Working at C+M is like playing a piano with endless different combination possibilities. Over the 135 years of its existence, the company has always managed to play the right tune. (Ronald J. Lenzeder, CEO C+M Medtech).



Luxury+Industry

Medtech

Exhibit 26.5 Cendres + Métaux product line

Company Profile 6: Lantal Textiles¹⁰—Global Leader for Aircraft Interiors. From Cheese Cloth to Seat Covers

When Friedrich Baumann and Albert Brand established the Baumann & Brand linen weaving mill in Langenthal in 1886, the forerunner of Lantal Textiles, they laid the foundation for a company that would become a world leader in an industry nobody could have imagined at the time. In 2018, Lantal supplied seat covers and complete interiors for the air, train, bus, and executive transportation industries. Lantal had consolidated sales of CHF 105 mio with more than 700 employees, 288 based in Switzerland. Lantal had subsidiaries or sales offices in the USA, Singapore, France, Czech Republic, Portugal, Germany, and the UK, 94% of sales went into export.¹¹

Beginning as a Linen Weaving Mill

Friedrich Baumann (1858–1930) had trained as a merchant with Tuchhandlung Bolliger in Aarau (AG) before taking over the representation of the textile factory St. Quentin in Paris. During his travels, he met Albert Brand and together they founded Brand & Baumann on October 1, 1886, in Langenthal near Berne. Originally, the company produced cheese linen, as Langenthal was a gateway to the Emmental region where production of Emmental cheese was of central importance. The company was one among several textile companies in the region weaving cheese linen, needed by cheesemakers on a daily basis. Soon, Brand & Baumann realized that relying on cheese linen alone lacked promise, prompting the company to expand its product range into white goods and tablecloths.

Turning into Upholstery Weaving Mill

When Friedrich Baumann died in 1930, sons Fritz and Willy Baumann assumed control of the company as second-generation owner-managers. After some time, they parted ways. In 1951, Willy Baumann founded Möbelstoffweberei Langenthal AG (“Upholstery Weaving Mill Langenthal Inc.”), which was later to become Lantal. The company entered the market for textiles used by the furniture industry, and especially seat covers for office chairs, which was a typical contract business. In addition to customers from Switzerland, it also generated business from other European countries, soon becoming the main business of Lantal. The other brother, Fritz Baumann, founded Création Baumann, specializing in curtains, still existing today.

¹⁰This profile was written by Heiko Bergmann (Adjunct Professor of Entrepreneurship University of St. Gallen) based on an interview as well as publicly available information. Copyright ©2019.

¹¹Although the company did not adopt the corporate name Lantal Textiles until 1996, the name Lantal was used throughout this profile.

New Market Opportunity Opened by Chance

Not planned strategically, but by sheer chance, the weaving mill was offered an opportunity to enter the still young aviation industry. Sometime in the very early 1950s, the Dutch national airline KLM had become aware of Lantal because of its high-quality seat covers and approached Lantal about an interest in developing seat covers for the aviation sector. For Lantal, this was a new challenge and the Baumann family debated whether to accept. Lantal already sensed that the market for office chairs was turning increasingly competitive, viewing the aviation sector as an exciting new market. However, coming from the office chair business, Lantal also realized that a number of new and unfamiliar requirements had to be met. Seat fabrics had to be flame-retardant, smoke-free, and free from poisonous gases in case of fire. For companies not used to these requirements, it was very difficult to meet them. Furthermore, a supplier had to prove compliance with these high standards on an ongoing basis. In addition to the flammability requirements, low weight, light fastness, durability, and ease of cleaning were of critical importance to the aviation industry.

The first fabrics were delivered to KLM in 1954 to the full satisfaction of the airline. As a result, Fokker Aircraft Netherlands also approached Lantal, ordering seat fabrics. After initially supplying these aviation companies, Lantal began to think more strategically about this business opportunity, viewing the aviation industry as particularly interesting due to its volume potential. Lantal recognized the chance for differentiation through quality and, early on, realized the importance of the US market in this industry.

Moving into Ground Transport Sector

Early on, Lantal investigated whether know-how acquired in the aviation industry could also be used in ground transport, producing seat covers and interiors of busses, trains, and trams. However, ground transport, especially rail, imposed different requirements depending on where the trains were deployed. For example, trains regularly running through tunnels were subject to stricter requirements. For many years, each country maintained its own standards regarding rail transport until a Europe-wide standard was recently adopted.

In 1956, Lantal acquired Meister AG in Zurich, the weaving mill producing velvet textiles for trains and buses. Plush was well suited for buses and trains but too heavy for airplanes. This acquisition allowed Lantal to enter the ground transport sector.

Establishing Subsidiary in the USA

In 1964, Urs Baumann succeeded his father at the head of Lantal as third-generation CEO. Enthusiastic about the aviation industry, he completely rebuilt the company,

increased production capacity, and fostered the development of the US market, visiting the country in 1972 and opening two sales offices there. Then, in 1979, the company made the decision to open a weaving mill in Rural Hall, North Carolina, producing mainly for the US market. The North Carolina location was chosen, because it was the center for the US textile industry. The subsidiary in the USA operated independently of the Swiss operation remaining closely tied to the Lantal corporate strategy. Finally, internationalization of Lantal called for an internationally comprehensible name, prompting Lantal to shed its old name and adopting Lantal Textiles in 1996 as its corporate name.

Managing Multiple Production Technologies

As Lantal was winning more and more customers, its customers increasingly asked for carpeting, given the quality of Lantal products. When the opportunity arose in 1985 to acquire a carpet weaving mill in financial difficulties in nearby Melchnau, Baumann decided to proceed. From that moment on, Lantal offered both seat fabrics and carpeting from a single source.

Carpet weaving machines could only be used for the production of carpeting and not for any other fabric. For airplane seat fabric, flat weaving was the technology of choice, completely different from carpet weaving and plush/velvet weaving, requiring different technologies, machines, and processes. In addition, Lantal produced hand-tufted carpets for very special purpose applications. Overall, Lantal became the only company in the world able to offer products based on all four different production technologies from a single source: carpets, velvet, flat woven fabric, and hand-tufted carpets. Lantal was then able to plan an entire interior, supplying every product for cabin interiors, while competitors offered specific products only, forcing them to cooperate with other suppliers to offer complete solutions.

Transferring the Company to New Ownership

With Urs Baumann's daughters not interested in assuming leadership of Lantal, Baumann started to look for succession options. With the help of a headhunter, an external CEO was recruited. In 2003, Urs Rickenbacher joined the company as new CEO. Holding a doctoral degree from the University of St Gallen, he had risen to head the German subsidiary of USM, a leading Swiss furniture manufacturer. Within 1 year, as part of a management buyout in 2004, majority ownership of Lantal was transferred to Rickenbacher and other senior executives.

Joining Lantal, Rickenbacher, together with the existing management team, introduced a number of strategic changes. Rickenbacher had come from a related, but different, industry which he considered an advantage, allowing him to see things from a different perspective. Analyzing what distinguished Lantal from competitors, the new management team realized that mastering four different production technologies represented a core strength. While these individual technologies were

already present within Lantal, they had not been used to position Lantal as a system provider, offering complete solutions. Lantal began to strategically position itself to cover the entire interior of different transport vehicles and to offer customized solutions. To compete on supplying everything from a single source became the guiding vision for the company. This way the company was able to coordinate timing, design, and logistics, freeing customers from the burden of sourcing from different suppliers.

Extending Value Added

In a second strategic change, Lantal started to enhance upstream processes by offering complete, customer-specific solutions, going beyond ready-made arrangements. Specifically, Lantal offered early on design and communication services. Acknowledging the different roots and cultures of transportation companies, Lantal offered tailor-made solutions in keeping with the identity of each customer. In 2017, there were 21 professionals in Switzerland and 4 in the USA working in areas of communication, branding, and design, offering these services for a fee. As an example, Lantal employees worked closely with Thai Airways and, based on several extended stays in the country, developed a deep understanding of the company's and Thai culture over the years. Being close to customers and offering integrated solutions, Lantal aimed at becoming less replaceable. While technical capabilities were interchangeable, deep understanding of what a customer really wanted was far more difficult to achieve. In addition, Lantal offered ready-made and made-to-measure seat covers, as well as curtains and carpeting, both labeled and made to company specifications.

Developing a Revolutionary Seat

Lantal regularly innovated, offering new products, standards, technologies, patterns, or new material compositions. The goal was to annually deliver one innovation per market. Concerning seat covers, innovations typically consisted of new material compositions of ever-higher quality or durability. A team of six R&D professionals searched for new and innovative solutions, scanning new trends accessing all available information, engaging with universities, and generally thinking outside the box.

One such important innovation had been the pneumatic seat system. The idea for this seat came from Baumann himself. Around 2000, invited to an event of an innovation company, he discovered a seat along a wall, inflated solely with air. Curious, Baumann learned that air could be used to build structures of extreme resilience and resistance, triggering the idea to build airplane seat cushions based on this technology, avoiding the use of foam. Lantal started development of an aviation-suitable product from scratch, cooperating with Swiss-based maxon and Sarna

Plastec, as well as an external innovation company. Lantal acquired the latter and created a completely new engineering department in-house.

Based on Lantal's textile know-how, this new department developed a concept with three layers for the new business class seat at 2.5 kg lighter than previous seats. The pneumatic seat offered higher comfort for passengers and, with the advantage of lower weight, reduced fuel consumption. The first prototype was installed in 2005 and entered into service in 2008. Swiss Air became Lantal's first customer. From then on, demand increased steadily.

For the pneumatic seat cushion system, several patents were filed. In most other cases, Lantal refrained from patent filings. Rather, Lantal aimed at being faster in bringing new products to market and being generally ahead of the competition. Lantal did not concentrate on individual products alone, because fabrics could be copied more easily than other products, instead concentrating on complete systems that were more difficult to copy.

Dual Strategy Targeting Both Budget and Premium Segments

In 2017, Lantal worked with more than 300 airlines from all continents, premium as well as budget. Lantal was interested in working together with low-cost airlines because they posed different challenges than premium airlines, demanding seat covers requiring longer intervals between changes. As customer proximity and customer support were of great importance, Lantal began to offer additional services. For Singapore Airlines, one of its most important customers, Lantal set up warehousing, storing carpeting cut to size for each aircraft model, as well as seat covers ready to go. This allowed Lantal to change parts of an aircraft interior within 6 h, taking care of replacement and logistics. In partnership with Etihad, Lantal set up the first and only fire laboratory in the Middle East in Abu Dhabi in 2016.

Competing in a Volatile Industry

In 2017, the aviation industry accounted for about two-thirds of Lantal sales; 30% were accounted for by ground traffic, with the rest stemming from premium segment, such as VIP or yacht interiors. Worldwide, Lantal enjoyed a market share of 65% in aircraft seat covers and curtains. In the aviation industry, 90% or more were represented by customized interiors. Lantal offered few standard products, customizing as much as possible.

The aviation industry was highly volatile. With 95% of Lantal sales based on project business, a project could be postponed for any number of reasons, creating an immediate impact on sales. As a result, Lantal often had deviations from plan, ranging from +/- 35% on a monthly basis. To compensate without having to resort to layoffs, Lantal had developed a model where staff trained intensively for multifunctionality, able to work in all three production sites in Switzerland. Crises in the aviation industry have led to some downsizing in the past. As a result of the

9/11 terrorist attacks in the USA, several airlines canceled orders and Lantal's sales decreased from CHF 121 mio in 2000 to CHF 89 mio in 2003. Some years later, after partly recovering, following the global financial crisis, sales again dropped by 24% to CHF 86 mio. Lantal once more recovered, reaching sales of in excess of CHF 100 mio in 2014.

Reducing Dependence on Airlines

Eighty percentage of Lantal's production for the aviation industry originated from Switzerland and 20% from the USA, forcing Lantal to sometimes forego a sale to maintain its premium price level required for supporting the production base in Switzerland. To offset the strong dependence on the airline market, Lantal expanded its ground traffic and yacht divisions. In 2016, Lantal acquired Portugal-based Gierlings Velpor, specializing in plush for ground traffic sector. Strong price competition in this market made it important to produce in a low-cost location while maintaining high-quality. The new production site in Portugal helped Lantal entering new markets that could otherwise not be approached.

In 2018, Lantal maintained a sales office in Seattle ensuring customer proximity to Boeing. In Europe, Lantal had a sales office near Toulouse serving Airbus. In Asia, Lantal had established its own hub in Singapore, as well as a facility in Abu Dhabi.

Nurturing a Unique Company Culture

Lantal operated with an open and direct culture, inviting independent thinking and commitment to work. All employees, invited to contribute their own ideas, were granted personal space tolerating mistakes. Every 3 months Rickenbacher took time to spend a day with about 10 new employees, discussing with them Lantal's past trajectory and where the company was headed. Lantal's ability to consistently deliver high-quality products owed much to its highly qualified and experienced employees. Lantal enjoyed a very low fluctuation rate among its staff where some employees represented the third generation of their family working with the company.

Corporate Governance

Since the MBO in 2004, Lantal was owned by Rickenbacher, CEO, and other shareholders, all involved in managing the company. Rickenbacher considered this an advantage, providing the company with a strong forward momentum and motivated partner-colleagues. Lantal was governed by three bodies: management, partners (shareholders), and board of directors, the latter consisting predominantly of external members not active in the company. When Baumann, at 70 years of age,

stepped down from the board, he suggested to Rickenbacher, as the main shareholder and CEO, to become chair of the board. However, Rickenbacher declined because, in his view, such a move violated basic principles of good corporate governance. As CEO, he preferred to be challenged by external board members with extensive business experience.

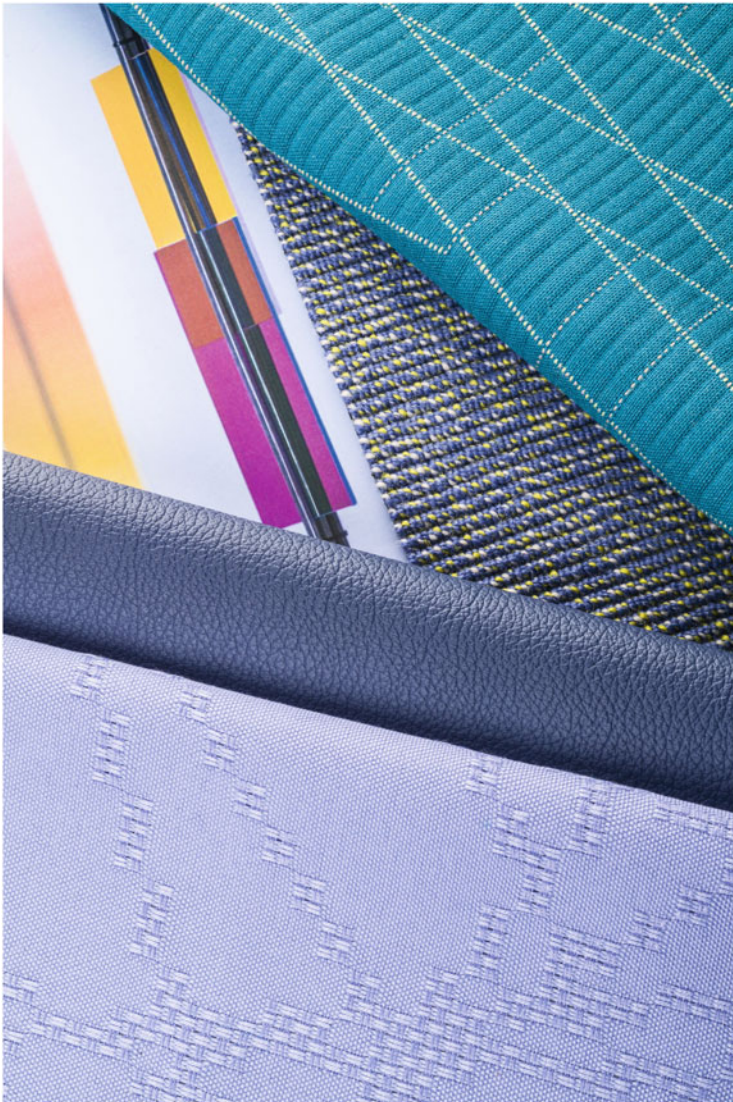

Exhibit 26.6 Lantal product samples

Company Profile 7: Max Felchlin AG¹²—Gold Medal Winner for the World’s Best Chocolate.¹³ Supplying the World’s Leading Pastry Chefs

From Honey Trading to Chocolate Couverture Master

When Max Felchlin (1983–1970) created his honey trading business in 1908 in the town of Schwyz, there were few indications that this little trading company would someday dominate the world of patissiers and chocolatiers with its chocolate couverture. Starting from this small operation, Max Felchlin, Sr., and later his son Max Felchlin, Jr., built the foundation for a company that professional creators of pralines and other chocolate specialties worldwide would rely on for a key ingredient in their creations. The company grew, step by step, to reach about 150 employees with sales estimated at CHF 60 mio, earning the highest praise for its quality and creativity. That a small niche competitor in Switzerland, a country of major global chocolate companies, should survive and blossom over more than 100 years deserves special attention.

Starting Out as Honey Trader

Max Felchlin, Sr., grew up in Schwyz as the younger son of a local cherry brandy distillery owner. Since his older brother was to take over the distillery, Max needed to find another activity for himself. Trained in the commercial side of business, he had already traveled abroad at a young age. In 1908, at the age of 25, Max began to import and trade in honey. His sales were focused on professional bakeries and pastry shops that used honey as a sweetening ingredient. Today, we would say he concentrated on B2B business model, a term not known back then. The company was to remain loyal to this customer group until present times. In 1913, Felchlin opened his business formally as “Honey Center Schwyz,” and it continued to grow.

Around 1918/1919, at the conclusion of WWI, Max traveled for 6 months to Central America where he wanted to learn more about beekeeping, honey-making, and the honey trade. Journeying on to Cuba, he shipped his honey from there in barrels to Europe. The difficulties of honey imports and respective price increases motivated Felchlin to produce a form of sugar- and herb-based *baking honey* under the “Herbst” brand, to be used as baking filling. Other products were also imported, such as cocoa, baking powder, and couverture, even some chocolate, and sold along with honey to the bakeries and pastry shops. As the business grew, Felchlin moved

¹²This case was written by Jean-Pierre Jeannot (Professor Emeritus Babson College [USA] and IMD Institute [Switzerland]) on the basis of a company interview as well as from public information. Copyright©2019.

¹³Awarded in 2004 by the “Accademia Maestri Pasticceri Italiani” for its “Maracaibo Clasificado 65%.”

the operation to nearby Seewen in the early twenties and built the villa Liebwylen outside the town of Schwyz as his residence, later to be turned into an administrative office.

Refusal to Supply Felchlin Led to Entry into Chocolate Segment

As the product portfolio of Felchlin, marketed to professional bakery and pastry shops, continued to grow, the chorus for including chocolate in the portfolio became stronger. The large chocolate producers in Switzerland, however, refused to supply Felchlin, commenting: *If these shops want to buy chocolate, they can come directly to us. We do not need an intermediary for this!* This refusal to supply motivated Felchlin to strike out on his own. Felchlin, Sr., ever the innovator and tinkerer, developed his own chocolate manufacturing process and introduced his own brands of chocolate under the names of Felcor, Ambra, and Edelweiss, which were to become popular in Switzerland, as well as launching “Pralinosa” a unique praline filling made from hazelnut.

Overcoming Difficulties During WWII

Anticipating difficult times, Felchlin with some foresight acquired extra supplies of raw sugar and cocoa, main ingredients for his business. When the borders were closed for much of the needed imports, Felchlin, ever the innovator, created “Everest” powder sugar and the cream powder “Sowiso” to replace lacking sugar imports. After the war, Felchlin could resume normal operations and the business continued to expand, serving his professional bakery and confectionary customers. In 1962, at the age of 79, Felchlin, Sr., decided to turn over his business to the second generation of Felchlin.

Second Generation Takes Over 1962–1992

When Max Felchlin, Sr., decided to step out of the business in 1962, there was some question as to who should take over. Felchlin had three children, two daughters, and a son Max, Jr., who early on worked briefly at the company. But father and son had a fallout and Max, Jr., left the company. Max, Sr., then favored his older daughter to succeed him. Eventually, however, he did turn over the business to his son who was to lead the company for 30 years.

Max, Jr., had worked with several large US companies and had a particular liking for marketing. He was described as eccentric, interested in art, a talented writer, and an avid traveler. He spent some time in the USA where he met his wife Suzanne who was highly intelligent and played an important part in her husband's professional life. The couple had two adoptive sons.

With Max, Jr.'s, penchant for marketing, he did not share his father's flair for production processes. He focused primarily on ramping up the export business and, together with his wife, traveled widely. Max, Jr., did have the good sense to always hire exceptional talent to head production, and he could also rely on a CFO known for his conservative approach to financial affairs. Max, Jr., early on realized that the B2C business was not for them and refocused the company again on B2B customers, a move to which the company continued to adhere. His decision to buy land in the nearby town of Ibach demonstrated his foresight as this allowed the company to eventually expand production in several stages beyond the original site. Production moved into a new factory in Ibach in 1974, a time when the legal statutes of the company were also changed from single proprietorship to an incorporated firm named Max Felchlin AG.

Max, Jr.'s, management style was in line with his personality. He would hold legendary daily "Mail Conferences" where he presided over a management team meeting, personally opening and going over all incoming mail and distributing it among his management team.

Pursuing Global Market Expansion

Into Max, Jr.'s, reign at the helm of the company fell the expansion into export markets, particularly into the USA and Japan. This export drive, however, did not come as a result of an intended, well-planned strategy. Rather, the export growth was customer led, pulled from the professional users in the USA and in Japan who wanted to have access to Felchlin products for their creations.

Despite Max, Jr.'s, extensive contacts to the USA through his previous personal and business experience, he never leveraged those to build the US export business. Bakery fillings, Felchlin's main product for decades, were hard to export as moisture problems posed packaging challenges. As it turned out, *the USA came to Felchlin*. Baumann, a young chef who was acquainted with many Swiss and Europe-trained chefs in the USA, let the company know that *we could sell European raw materials to the US market*. An importer was appointed, and step by step, the business expanded.

Entry into Japan came about in a similar, ad hoc manner. As part of his extensive travels, Max, Jr., visited Japan in the 1970s. Given his talent for writing, he authored articles in the *Neue Zürcher Zeitung* (NZZ) about Japanese food and nutrition. As Siber Hegner, a large Swiss exporting company with a major presence in Japan, was looking for hazelnut bakery filling to sell in Japan at that time, Felchlin was contacted and the business developed: A Felchlin Club was established where Japanese traditional confiseurs could learn about Western-style confiserie. As a result, Felchlin was present very early on during the rise of the Japanese confiserie and pastry scene that today had eclipsed those of Europe and France and was now recognized as leading worldwide.

Preparing Ownership and Governance Structure for Transfer to Third Generation

As Max, Jr., was getting on in age, he began to wonder what to do with his company. His two adoptive sons were not active in the business. The company was small, but profitable, and in the late 1980s, Max, Jr., was known to have looked around for a buyer. It is believed that he could not find a buyer who would pay the premium demanded for his niche business. In 1990, Max, Jr., founded an “Association to Promote Business and Culture in Canton Schwyz” controlled and supported by the Max Felchlin AG. During the search for a buyer, Max, Jr., became close to his senior auditor of his company and the association who was increasingly becoming his confidant for business decisions.

During his almost 30-year tenure as head of the company, Max, Jr., wore many hats: He was the CEO, the Chairman of the Board, and he headed the not-for-profit association he had created. He wanted to find replacements for his three roles as well as to separate business control and ownership from the income stream generated.

The structure eventually adopted in 1991 was rather unique. Ownership was divided equally among 1200 shares, each bearing one vote. The bulk, or 1000 shares, were placed with the “Association to Promote Business and Culture in Canton Schwyz” who became de-facto owner of the company. The association, with a self-constituted board of five to six persons, was instructed to continue to own and run the company as long as feasible and to only sell the company if there were no other options. Max, Jr.’s, two sons received 100 shares each. The distribution of the company profits and dividends were also regulated so that one-third would be reinvested in the business, one-third would be for staff and employees, and the remaining one-third was for dividend distribution, with 90% going to Max, Jr.’s, two sons, Max-Peter and Joe, and 10% to the Association for sponsoring of local activities. This was the structure Max, Jr., chose to assure that the business would continue.

Finding Third-Generation Aschwanden

At the end of this process of restructuring ownership, Max, Jr., still needed to find a replacement for his role as CEO. Since his sons were not considered, the next generation of management had to come from outside the family. In line with his eccentric ways, he orchestrated a recruiting process that the eventual chosen person, Christian Aschwanden, remembers distinctly:

One day in 1991, I was working then with Lindt & Sprüngli, the large Swiss chocolate manufacturer, I saw an ad in the paper describing the opening of the CEO job at Felchlin. Given my background as a food processing engineer and working for Lindt, I got up my courage and applied. I was invited for an interview, but venue and format were rather unique. All applicants, including myself, and there were many of us, were invited on a boat ride on Lake Lucerne. On the boat were all senior managers of Felchlin, Max, Jr., included, and we were encouraged to ask questions. After this event, I returned home and did not hear

for weeks. Then, suddenly, one evening, I got a call at home (I lived near the town of Schwyz), with Max, Jr., on the phone asking me to come on over to his home. That is when I was offered the job.

Christian Aschwanden assumed his position in October 1992. Earlier that year, in July, Max, Jr., passed away. He had been suffering from liver cancer. As Aschwanden would comment years later: *In a way, I am the third generation of Felchlin.*

Felchlin Grand Cru Story

When Aschwanden assumed the leadership at Felchlin, he found the manufacturing operation had been neglected for some time. Aschwanden came from Lindt and had a strong background in both food processing and the chocolate industry. Many confiseurs bought chocolate, melted it, and processed it in their creations. But this was not an ideal source for their ingredients. Chocolate used by confiseurs for praline couverture was richer in nature, contained more cacao butter on top of regular butter, and the confiseur worried about how it melted and flowed.

Up to now, industry treated all cocoa beans as being the same, essentially as a commodity. Aschwanden and his team decided to take a page out of different industries and to develop a chocolate product line made from distinct, labeled and identified, beans, such as was the case in the coffee industry. The Felchlin team was intent on going back to the roots of cocoa and identified special growers in South America who were small-lot farmers organized into cooperatives. This would avoid the child labor issues. Felchlin would pay more than 10% above going fair trade prices, such as for beans originating from Maracaibo in Venezuela. The resulting Grand Cru Selection consisted of single-origin couvertures, similar to single malt spirits.

The cocoa bean purchasing policy was instituted by Felix Inderbitzin, Head of Purchasing at Felchlin, who sourced from the small-lot farmers at sustainable and fair conditions. With its purchase volume of 1500 to 1700 tons annually, Felchlin was a minor player in the cocoa purchasing game. Switzerland, with its chocolate producing companies, imported 1% of global cocoa volume, and Felchlin accounted for only 3% of that total.

Sourcing rare beans and making excellent chocolate suitable for praline couverture was not sufficient. All processing steps to arrive at the chocolate were made by Felchlin in its operation in Switzerland. Cleaning, roasting, milling, kneading, rolling, and conching were the steps performed internally to meet the highest levels of fineness. Milk was sourced from the special UNESCO Biosphere Entlebuch in Switzerland.

To market these specialties, a new language had to be created. For that purpose, Felchlin leveraged the experience of the agricultural and wine-growing department of the University of Applied Sciences in Wädenswil, half an hour drive from Schwyz

on the lake of Zurich. In cooperation with that school, Felchlin developed a language to describe taste differences of chocolate flavors and cocoa beans.

The process of moving into the Grand Cru product line was accelerated in 1999 with the launch of the single-origin couvertures, eventually leading to some 25 different crus, classed according to many levels of cacao, flavor intensity, milk intensity, plus vegan, or lactose-free combinations.

Creating a School for Chefs

Felchlin marketed complex products that required considerable explanation for selection of tastes and how to apply them. For this purpose, Felchlin created Condorama in 1988, located in Schwyz, with the aim to show professionals how to do it right. The school attracted 1000 to 1500 visitors annually. Swiss customers enrolled in one-day courses that did not include overnight stays. International customers, however, enrolled in 1-week courses requiring a residential period.

Condorama was run as a cost center. Swiss-based customers, when ordering products, received points, a form of frequent flyer miles, which then could be used to gain access to the courses at no additional cost. International customers, or users, were typically sponsored by their importers for their travel costs, and Felchlin covered local food and lodging during their stay.

Maintaining a Competitive Edge

As a very small player in the field, Felchlin was up against some giants. Valrhona, its strongest direct competitor, based in France, was about 10 times the size of Felchlin and part of a large food conglomerate that also owned the Swiss chocolate producer Villars. On the other end of the scale was Barry Callebaut, an industrial chocolate producer strong in the B2B business segment and no presence in the consumer business.

Felchlin continued to adhere to its B2B business model targeting professional confiseurs and pastry chefs. Smaller industrial customers, such as Kambly Biscuits or Mövenpick Ice Cream, sourced from Felchlin as well. For custom-made batches, minimum order quantities were one ton, dictated by the equipment size installed. Felchlin needed to compete against lower-price competition from its high-cost location. Sometimes, customers started with small batches for a new product and, when volume expanded, went elsewhere for supply. In that case, the search for new customers started all over at Felchlin.

New ideas were constantly pursued, and many of them stemmed directly from clients who met with the company at Condorama. A special role in this process played in-house tasting panels. Felchlin employed no external tasters. Every month, there were internal taste panels and cacao bean panels. Its employees were trained in sensory tasting. The company considered taste to be key in its business and viewed it as important that its employees cultivated the specific language for expressing taste.

In its international marketing activities, Felchlin was able to exploit *Swissness* by surpassing the required limit for value added in Switzerland. It sourced 80% of raw materials available in Switzerland and 100% of its milk from Swiss suppliers. In its publications, the company did not see a need to display much of the Swiss flag. Word about Felchlin was also spread by a small group of key account managers located in Dubai, India, and North America who worked with key customers in the roles of Felchlin ambassadors. Global distribution to about 40 markets was assured by independent distributors experienced with Felchlin's customer group.

Investing in the Future

Due to the vision of Max Felchlin, Jr., sufficient land reserves were available to centralize all of Felchlin's activities on a single site in Ibach. After the expansion of the cocoa bean roasting facility in 2012, Felchlin began the process of planning and constructing an additional building that allowed for the entire company to be located on a single site. To do so, Felchlin planned to vacate the old villa and adjacent buildings to move next to the Ibach site. Management considered proximity and close communication to be of special value for a small business. The investment of the last building expansion was budgeted at CHF 20 million.

Ever since his appointment as CEO in 1992, Aschwanden had been reporting to the board of the "Association" who owned the majority of the company shares:

As long as we as management do it right, we are free to act. The Association in fact brings long-term thinking and avoids short-termism.

Time to start the search for the fourth generation of management?



Exhibit 26.7 Max Felchlin product

Company Profile 8: Plumettaz SA¹⁴—From Winching to Blowing Cables. World Champion in Cable Installation Equipment

The Cable Laying Experts in Bex (VD), Switzerland

Located in the town of Bex (VD), in the Chablais district, a flat area between the entry into the Valais and the beginning of Lake Geneva, Plumettaz was a company with sales of about CHF 27 mio and employing a staff of about 100 at that location. Another 20 employees were located in Shanghai, Singapore, and Rotterdam. Its relatively small size did not do full justice to its importance in a niche market, namely the laying of cables, in particular for the telecommunications industry. Whether the task consisted of laying fiber optic cables or even high voltage cables, Plumettaz had developed a range of equipment that allowed the global telecom industry to carry out cable laying with maximum efficiency. Its origin, however, was as a supplier of equipment for the wine-growing sector.

¹⁴This case was written by Jean-Pierre Jeannet (Professor Emeritus Babson College [USA] and IMD [Switzerland]) on the basis of a company interview and publicly available information. Copyright©2019.

At the Outset a Strong Urge to Become Independent

Emile Plumettaz (1885–1958) worked as a foreman mechanic in a Nestlé condensed milk factory in his hometown of Payerne (VD). It is reported that one evening he revealed to his elder son Fernand, who showed signs at a young age to be also an adept mechanic, that he had acquired a workshop in Vevey, the town of the Nestlé head office, and that he hoped that someday Fernand would join him there and eventually take over the business.

Prototyping as First Opportunity

The business opened in 1923 as a three men workshop. Emile's first patented equipment was a cherry stone-pitting machine. The business also became an agent for all kind of machines and motorcycles. Plumettaz developed several machines for use at Nestlé, including a labeling machine and a paper-strapping machine. This was the time period when gifted mechanical engineers could find plenty of opportunities to create machines that replaced manual labor in industrial processes. By 1929, Plumettaz prospered and employment had increased to 15, necessitating a move to new and larger building premises in Vevey.

1930s: Market Collapse Led to New Opportunities in the Nearby Vineyards

The impact of the worldwide industrial crisis in the 1930s soon reached the doors of the still small Plumettaz workshop. Nestlé, its major customer, pulled machining work in-house, necessitating a reorientation of the Plumettaz business model. Plumettaz stopped production of food industry equipment and soon found new opportunities right there on the steep slopes of the Lake Geneva vineyards. In quick succession, Emile Plumettaz developed a number of cultivating machines designed specifically to plow the steep and narrow vineyards typical for the region: With the help of motorized winches, the plows could be pulled up the steep inclines. It took all the salesmanship of Plumettaz to convince traditional and conservative wine growers to adopt his new methods. The business continued to struggle and, with exports impossible during WWII, had to concentrate exclusively on the small Swiss market. It was during this time that the business became known as the Manufacturer of Vineyard Cultivation Machinery under the brand name of Plumett, still in use today. To finance the business, Emile Plumettaz had to sell his real estate and rent space back. It was during this period that Emile's oldest son, Fernand, joined the company in 1943.

1940s: Emergence of Proprietary Capstan Winching Technology as the Core Know-How

Of particular importance was the development of special winches. The Ruedin drum winch was produced under license, and the Lederey capstan winch, conceived by a local winegrower, were important technical developments. It was in particular the capstan winch technology that was for Plumettaz to become a mainstay and central technology base for future winches. The capstan technology differed from standard single drum winches through a double drum mechanism to keep the reserve line, allowing for a small holding force one side to carry a much larger holding force on the other side.

Important in winching was the synchronization between vehicle, and power source, and the winch itself. Simple drum winches had always issues with force and speed. Capstan winches were able to keep force and speed constant. These elements were important when bringing the winches into the vineyards or other agricultural applications. Thus, the capstan technology became the central technology and platform around which Plumettaz developed entire generations of winches for a large number of different applications.

First Export Business After WWII

With the end of WWII and the reopening of borders, it became possible for Plumettaz to export its vineyard equipment to France. Fernand Plumettaz traveled extensively in France to convince the wine-growing community in hilly terrain of the superiority of “Plumett” branded equipment. The market for vineyard cultivating machinery in France developed rapidly, and at times, Plumettaz was shipping equipment by the railway carloads. Then, suddenly in 1949, and due to currency fluctuations, Plumettaz saw its main market decline. Once more, the company was looking for alternative markets. What was different this time was its new capstan technology platform, which allowed it to look for different applications of a technology it had already perfected.

Second Generation of Owners Brings Entry into the Circulating Pump Business

When Fernand Plumettaz, son of the company founder, joined the company in 1943, he leveraged his previous experience in a central heating business. Given Plumettaz’ manufacturing skills and Fernand’s engineering background, the company soon became a supplier of water circulating pumps for central heating systems. This business was eventually abandoned for the production of oil circulating pumps installed in large transformers in electrical locomotives. An initial order of oil circulators for some 195 locomotives for the Yugoslav railways resulted in a steady business that was to continue to today. Plumettaz supplied oil-based circulators of

Sécheron Group in Geneva as an OEM component supplier. This business continued until the present time despite the lack of any synergy with the rest of the Plumettaz business.

1950s: Plumettaz Develops a Tractor-Mounted Winch

Around 1950, Plumettaz developed a tractor for vineyards with a mounted capstan winch. The company, who had become a major equipment supplier of large French vineyards, soon realized that the heavy winches were difficult to transport into the vineyards usually located some distance from the villages. After trying out several ways to make the winches mobile, the company settled on building a self-propelled vehicle in the form of a 4-wheeled tractor, which soon became a big success. A first batch of 100 tractors was built in 1953. Unfortunately, with the liberalization of tractor imports into Switzerland, Plumettaz found itself unable to compete with international tractor companies. Production was ceased in 1956 after 256 tractors had left the workshops.

Need to Respond to Decline of the Vineyard Market

The end of the tractor business coincided with a big change in the cultivating methods of vineyards. Regular plowing of the vineyards was abandoned; therefore, no more winching plows on tractors up and down steep vineyards. This change of agricultural methods impacted Plumettaz heavily, which had become predominantly a supplier for viticulture.

Which other application could capitalize on the technical expertise with tractor-mounted self-propelled winches based on capstan technology? The closest, and most obvious, was found in the forest industry. Collaborating with the regional forestry services, the Plumettaz design office created two types of capstan winches to be integrated with Land Rovers, the 4-wheel drive vehicle popular in the forestry services and used for hauling timber onto the road. Other winches were installed in Aebi tractors for use on the steep meadows of the Swiss Emmental.

The Land Rover Connection Proved to Be Very Important

The installation of capstan winches onto Land Rovers brought the Plumettaz company to the attention of British Leyland, the Land Rover manufacturer. An initial order to equip scores of Leyland trucks were followed up by further orders, swelling the order books of Plumettaz. This led to the decision to buy out its agent in the UK, changing the name to Plumett Ltd and giving Plumettaz a manufacturing base in the UK.

The British sales agent maintained excellent connections to the British Ministry of Defense, which eventually led to the sale of capstan winches to a new generation of British recovery tanks and amphibious tanks for their armed forces.

The final opportunity arose from a business deal with the British Post Office. Owner of a large fleet of Land Rovers, the Post Office acquired Plumettaz capstan winches and retrofitted its Land Rovers for use in telephone cable laying operations. The conversion meant removing the front middle seat and installing a capstan winch in its place.

The British connection was to prove exceedingly important, because for the first time it took Plumettaz out of purely agricultural applications and into new fields that were to change the course of the company. The transition from vineyard equipment to cable laying for telecommunications had begun. By 1973, its 50th anniversary, Plumettaz sales for nonviticulture use of its winches for the first time exceeded wine-growing applications, a trend that was to continue and by 2018 viticulture sales accounted only for a very small percentage of company activities.

A Man Arrives in a Rolls Royce

The British connections were to prove important once more. An engineer at the British Defense Ministry who had become familiar with Plumettaz and its winches had a friend in the patent trading business. The two must have discussed Plumettaz, because the British patent seller showed up one day at the Plumettaz factory in Bex. *One day, a man drove up in his Rolls Royce and asked if we were interested in a patent that could improve gearbox functions through a speed reducer for winching,* recounted Denis Plumettaz, Executive Director of the company.

The Plumettaz engineers were intrigued enough to send one engineer to the UK plant that owned the patent. An exclusive licensing agreement was signed and the Plumettaz engineering team improved the idea to create its own Tranquart or Quadrant drive. This improvement of the gearbox, combined with its capstan drive technology, was leveraged to enter the staging market for the ever-growing number of skyscrapers with difficult window cleaning issues. The Quadrant technology allowed for much better speed control of the suspended gondolas, the work base of the crews. In 1983, a licensing agreement was signed with a US supplier of stage-mounted traction hoists. Eventually, Plumettaz was to build and ship tens of thousands of these Quadrant gearboxes.

Entering the Telecom Cable Laying Business

Plumettaz' entry into the telecommunications cable market began in the 70s with an initial order from the Swiss Telecom, then PTT, for three capstan systems for laying fiber optic cables. This was to be the beginning of a long-term partnership and a complete shift toward a new market segment.

The laying of optical fiber cables posed unique challenges. While copper cables needed a manhole every 500 m for access to join cables, fiber optic cables used longer intervals. But the typical cable pulling mechanism proved ill-suited to the more fragile fiber cables. As a result, telecom companies throughout Europe were looking for solutions experimenting with different technologies. The Dutch telecom company developed and patented an air blowing system that used a compressor to blow air through a tube holding the fiber. In 1987, The Dutch company offered this technology to a German competitor of Plumettaz who declined the offer. When approached, Plumettaz, however, quickly realized the potential of this new approach as it offered significant efficiencies in laying cable. Whereas winching could do about 15 m a minute, blowing could do 100 m at the same time. An installation team could thus lay 4 km of cable in one single working shift. Plumettaz took out a 20-year worldwide license. An entire new line of products was developed and branded Cablejet.

Once Plumettaz learned to drive cable installations by blowing rather than winching, it was natural to go the next step and develop systems that used water as a driver for moving larger cables. In the process, Plumettaz built a new competence around jetting of cables, a long way from the original plow winching.

Plumettaz Segment Selection Strategy Over Time

Over its close to 100-year history, the company experienced significant shifts in the composition of its sales, which originated from responding to opportunities in new market segments.

Starting out in the food industry with packaging and labeling, the company moved heavily into the wine-growing industry, developing new equipment and pioneering the capstan-type winches, eventually abandoning the food industry sector. Learning how to mount winches on tractors, jeeps, or other vehicles, Plumettaz compensated for the decline in the viticulture segment with various new equipment for lifting or pulling in nonagricultural applications. As the fiber optics opportunity developed, Plumettaz responded again and innovated beyond its established core competence in winching to develop cable-jetting skills.

In 2018, Plumettaz sales to the telecom industry amounted to about 55–60% of total and the other industrial applications accounted for about 25% of sales. The rest came from the railroad segment (oil circulators and level gate crossing mechanisms) and some remaining agricultural business. Denis Plumettaz, the company's Executive Director, called this their 4-legged-stool strategy.

Plumettaz Sales and Distribution Strategy

Global sales at Plumettaz were organized through four international sales subsidiaries, in the Netherlands, Singapore, China, and most recently in the USA. The network was augmented through some 50 distributors across the world. A small

number of international sales managers maintained contacts with key clients and supported agents from the company base in Switzerland.

Plumettaz supported its equipment sales by offering training of customer engineers. For each set of equipment, a customer was offered free training of one engineer. This partially compensated for the higher prices the company had to charge for its equipment almost entirely produced in Switzerland. Although the company viewed itself as No. 1, it faced competition from two German companies, as well as one in the UK and one in the USA. These companies often copied new Plumettaz solutions. Plumettaz had to rely on *Swiss quality* and Swiss engineering labels to offset its higher prices.

Plumettaz Production Footprint Focused on Switzerland

Over its almost 100-year history, Plumettaz moved premises many times, always in search of more space for its production activities. In the first 25 years, the company occupied different buildings in Vevey. In 1948, Plumettaz acquired land and created a new workshop in the nearby town of Bex where the company was still located. The production facility and equipment were constantly updated and increasingly automation was relied on to remain efficient with a relatively complex product line. Most production and sourcing were concentrated in Switzerland, with the Chinese subsidiary assisting in the sourcing of some components. The company shipped about half a dozen pieces of equipment each week.

The acquired operation in the UK was abandoned and the operation sold in 1987 with the acquiring company in turn becoming the Plumettaz sales agent in the UK.

Plumettaz Development and Engineering “Open Eye Principle”

Plumettaz engaged mostly in development, not research. On the research end, the company depended on two PhDs in physics and mechanical engineering. The engineering department maintained drawings. Three project managers who *took new ideas and put them into the system until reaching production stage* tracked the implementation of new ideas.

Plumettaz also engaged in partnerships with different industry players. In the telecom industry, Plumettaz collaborated with Swisscom as well as with Draka, a large Dutch cable manufacturer. These collaborations resulted in the development of new equipment better suited to the industry.

At Plumettaz we have always practiced the “Open Eye Principle.” New ideas come to us. In a way they find us. We have to be on the lookout for such new ideas and respond to them. This is how we came to bring the capstan winch to the market, how we came to the Quadrant drive gearbox, and that is how we came to the cable jetting business. Other, larger companies, tend to overlook such ideas (Denis Plumettaz).

Evolving Company Ownership and Governance

Started in sole proprietorship in 1923, the company had undergone several changes in ownership. In 1943, with the entrance of Emile's son Fernand, a trained engineer, the company was turned into a partnership. Olivier Plumettaz joined in 1947 in administration and finance. Upon the death of Fernand in 1978, Gérard, a trained engineer from ETH Zurich, joined to assume leadership of the company until 2008, when he retired and moved to Singapore. Denis Plumettaz, who graduated from EPFL Lausanne and a cousin of Gérard, joined in 1980, was COO and then CEO until 2016 when he became Executive Director of the company, and an external CEO was appointed. Most of the Plumettaz family members involved in the business had been engineers.

Up to 2008, for almost 80 years, Plumettaz had remained a family-owned company with more than 30 shareholders. However, few family members were active in the business. When Gérard Plumettaz retired at age 65 in 2008, a private equity firm took over 70% of the share capital. A holding company was created that held all the assets, and the private equity firm appointed an outsider as CEO. However, this appointment did not work out: the difference between a CEO from a large company and Plumettaz company culture proved to be too great to bridge. Two years later, in 2010, the private equity company invited the family back to manage. A different private equity firm has since acquired the stake and a new CEO from the outside was recruited.

Governance rested with a small board of four members, Denis Plumettaz, the newly hired CEO, and two PE company representatives. The company's new CEO, Philippe Prat, an engineer by training and education (PhD), had international experience, was a French national, and spoke several languages. Both Denis Plumettaz and Philippe Prat were also shareholders in the company.



Exhibit 26.8 Plumettaz product line

Company Profile 9: Caran d’Ache SA¹⁵—Global Leader for Sophisticated Luxury Writing Instruments. Pencils for Most Luminous Colors

From Soap to High-Quality Pencils and Writing Instruments

When a group of entrepreneurs founded Fabrique Genevoise de Crayons in 1915, converting a soap factory into a pencil manufacturing plant, they had to overcome considerable odds to compete against the dominant manufacturers in Germany, Austria, and Czechoslovakia who were enjoying a near monopoly for graphite pencils. Acquired by a new group of investors in 1921, the company was later renamed Caran d’Ache. The new investors nurtured the company over decades to reach sales of about CHF 100 mio and employing 300. Owned and presided over by the fourth generation of owners, the company was producing arguably the highest quality pencils available and that from an entirely Swiss manufacturing base in Geneva.

The First Set of Founders Divested

Three Geneva businessmen who had acquired the old soap factory and started the pencil business were, over time, joined by other investors, including a banker and a wheat trader. Starting from zero in terms of pencil manufacturing experience, they managed to produce three color pencils and various graphite pencils. The group marketed its products first under the brand name of Ecridor, the initial name of the new company. Its major innovation was the graphite pencil line “Technograph” with a graphite core, cedarwood casing, and embossed in fine gold. The line was composed of pencils with different hardness grades, aimed at different professions. Ecridor was then acquired by new owners in 1921.

Buyout and Relaunch

A new group of investors, headed by a local stockbroker, Arnold Schweitzer, and the industrialists Charles von Weid and Edmond Naville, assumed all assets of Ecridor in January 1924 and Schweitzer embarked on an ambitious reorganization of the company.

Schweitzer realized that to be competitive with pencils manufactured abroad, he needed to scrap much of the old equipment of Ecridor and build some of its own.

¹⁵This case was written by Jean-Pierre Jeannot (Professor Emeritus Babson College [USA] and IMD Institute [Switzerland]) on the basis of a company interview as well as publicly available information. Copyright©2019.

Innovations, such as the use of electric ovens for producing the graphite pencil cores, followed.

Schweitzer also hired a chemist to develop color pencils. Relying on pigment chemistry as the basis for many of its innovations, the company launched Polycolor as its line of color pencils.

Adopting Caran d’Ache as a Company Brand Name

One of the most lasting innovations introduced by Schweitzer and his new investors was a rebranding of the company name. He adopted as company name the pen name used by the widely known Russian-born French illustrator Emmanuel Poiré (1858–1909) who drew under the pseudonym of Caran d’Ache, and by 1924, all company products were branded under this name. It was related to the Russian term *karandash* for pencil which in turn had its origin in the Turkish language *kara tash* for black stone, the origin of graphite.

Bringing in New Investors

Although sales of Caran d’Ache pencils had been increasing in Switzerland, the economic crisis of the period meant that sales to many major export markets, such as Italy, Germany, and the UK, had dropped to almost zero. To achieve the ambitious goals of retrofitting the factory to launch new products and to develop export markets required an investment of more than CHF 5 mio, an amount beyond the means of Schweitzer and his partners.

With the help of, and through the connections of Joseph Reiser, a financial advisor and accountant, Jacques Hübscher, Sen., (1870–1938), a Swiss merchant and raw materials trader living in Marseille, provided the needed funds for continuing the development of the company. Intended as a loan to be repaid within 5 years’ time, Schweitzer did not have the funds to pay off the loan. Hübscher remained invested in the firm, later became a shareholder, and eventually joined its board of directors.

With new investors joining the company, governance and board composition were adjusted to reflect the changed ownership. Schweitzer remained as chairman of the board, as did Naville as managing director of the company.

From Investors to Managers

When Schweitzer sold his shares in 1946, the Hübscher, Reiser, and Christin families became owners of the company and were to remain so until to this day. Henri Hübscher (1894–1959), Jacques, Sr.’s, son, had assumed a controlling interest in 1947. Henri was to assume the position of vice president on the board and became CEO, a role he played until his death. Following Schweitzer, Joseph Reiser assumed

the board chair and remained on the board for a total of 56 years, eventually retiring in 1982.

After the death of Henri Hübscher in 1959, Reiser convinced Henri's son Jacques Hübscher, Jr., (born 1935) to move to Geneva and take the helm of the company. Jacques Hübscher, Jr., represented the third generation of Hübschers actively involved in the company and devoted himself with great passion to Caran d'Ache. Under his leadership, the company undertook a major international expansion, eventually reaching as many as 90 countries, added new writing instruments to its product line, and started with opening boutique stores.

In 1980, Jacques Hübscher, Jr., assumed the role of CEO of Caran d'Ache and became majority owner. Two years later, he also took over the board chairmanship from the retiring Reiser. He continued to bring new impulses to the company and expanded into the fine arts segment. Jacques Hübscher, Jr., remained CEO of the company until 1997 when a number of nonfamily managers were appointed to the post of the CEO. Hübscher remained chairman of the board until 2012 when his daughter Carole Hübscher assumed the board chair representing the fourth generation of the Hübscher family to lead the company.

Defining Market Space and Focus

Caran d'Ache defined its market as tools for drawing and writing. The company also saw its products as tools for creativity and independence. They were not to be considered throwaway products. The target audience included both children and adults, with sales about evenly split. Aside from school children, professionals such as architects, draftsmen, writers, and artists used its pencils. Among famous artists as customers figured Mirò and Picasso.

A second dimension to the market space segmentation were colors, as the company aimed at making a full range of colors available. The company's color scheme was based on the chromatic color circle developed by Wilhelm Ostwald (1853–1932), a German Nobel Prize winning chemist. The company's largest color lead pencil set included 120 different colors.

Constantly Evolving the Product Line

When still operating as Ecridor company, the Technograph pencil introduced in 1920 was the company's first major product improvement and a step into the direction of marketing superior pencils. Continuously in production since then, the pencil came in the four major hardness categories of HB, B, 2B, and 3B and had the characteristic hexagonal shape that prevented the pencil from rolling off an inclined table. The use of cedarwood was also introduced. In 1924, the Polycolor line of permanent color pencils was launched. This was followed in 1931 with the Primalo line, the world's first water-soluble line of coloring pencils.

The Fixpencil line was launched in 1929 in response to the difficulty of obtaining cedarwood. This represented the first mechanical pencil with a patented clamp mechanism to hold the graphite lead. Over the years, more than 20 such different models were introduced and the Fixpencil line remained in constant demand.

The following decades saw an expansion of the product line into water pastel colors under the Neocolor line in 1952, with Neocolor II as a watercolor version in 1972.

The expansion into other writing instruments began with the launch of the “849” ballpoint pen followed by the Madison collection of fountain pens in 1970. In 1980, and later, an expansion into related products took place, such as lighters, and other luxury writing instruments.

Honing the Craft of Pencil Production

Carole Hübscher, Chairwoman of the Board of Directors, likened the Caran d’Ache manufacturing process for the graphite “dough” for pencil cores to “cooking, similar to pasta or baking bread.” It involved 35 different steps, and the company owned about 800 different pieces of manufacturing equipment, many designed by the company.

A recent inventory of skills determined that Caran d’Ache staff covered about 90 different skills: from lead dough preparation to lead manufacturing, from the management of colors for pencils, to skills related to different materials, ranging from metal to plastic, to wood. Base skills required drew from chemistry, mechanics, woodworking, and lacquering.

With about two-thirds of company staff involved in production, finding the right talent was important. In the Geneva region, there was access to talent steeped in manufacturing products around metal, such as for watchmaking. But for many of the Caran d’Ache processes, staff had to be trained in-house with retention being an important issue. On average, employees had been with the company about 15 years with some as many as 40–50 years. Although the company participated in apprenticeship programs, for core manufacturing processes only in-house training would suffice as there were no other employers with similar needs in the region.

When the original site in central Geneva, the company’s location since its founding, became too small for the growing business, a new site was developed in 1974 in Thônex at the edge of the city of Geneva. However, the area around the complex developed into a residential area, making it increasingly difficult for transportation and delivery activity of about 20 trucks daily. The company was therefore planning to relocate to another site in Geneva that offered space for future expansion. Caran d’Ache was committed to remain and produce in Switzerland eliminating the option of moving across the border into nearby France. The label *Made in Switzerland* required a Swiss production site.

Differentiating Through Quality and Sustainability

With its prices about 20–25% above major competitors, Caran d’Ache was challenged to justify its price premium in terms of superior quality. Only perfection in its products allowed it to render a lifetime guarantee for its writing instruments. It combined sustainability processes with superior quality of the end product and was able to list quality along a number of dimensions. Its built-in “airbags,” for example, worked as shock absorbers for pencils when dropped on the floor. The pencil sets in boxes could be refilled with individual pencils, and the boxes themselves could be reused for other purposes. The company used twice as much gold as competitors to plate and emboss its pens and offered repairs or refills. All of these elements contributed to lowering the lifetime cost to the user while adding superior functionality and durability.

Caran d’Ache also wanted to differentiate itself through its sustainability strategy which while increasing production costs was of value to end users and society at large. The sawdust and shavings caused by shaping the cedarwood pencil casings were collected and used to heat the factory. Water-based varnishes on the pencil body took longer to dry while the competition still used solvent-based materials. The wood used for its pencils come from strictly managed forests. Throughout all manufacturing processes, Caran d’Ache took exceptional care to use nonhazardous materials.

Caran d’Ache received recognition for its quality processes and sustainability efforts from a number of certification agencies. Its environmental management was certified by ISO 14001.

Engaging in a Global Marketing Effort

Caran d’Ache had been looking for export markets early on, primarily in Europe. However, those sales significantly declined in the period before WWII, leaving the company with an effort to ramp up exports again after the end of the war. During WWII, sales primarily were to schools in Switzerland, keeping the company afloat.

Distribution in international markets was made through a few select subsidiaries in Japan, Germany, and France. The vast majority of the 90 markets of Caran d’Ache was served through independent distributors. Some of these distributors had been working with Caran d’Ache for generations and were selected and appointed partly on the basis of their fit with the Caran d’Ache philosophy. Shipments left the Swiss base within 48 h of order, and the invoicing currency was in Swiss Francs exclusively.

Export sales represented about 50% of all sales in 2000 and were consistently trending up. To increase sales abroad, the company engaged in shop-in-shop selling, as well as in duty-free zones at airports. In China, the company collaborated with a partner around an art center concept.

Using the Internet and social media became important for Caran d’Ache as well. The company believed that 80% of the population would look up products online

and then go to a store. The company opened its own e-shop on the Internet. Overall, Caran d'Ache was investing about 10% of sales in marketing activities.

The most recent development was the building of concept stores. The company came to the conclusion that a retail store of its own was needed in Geneva. This was as much for marketing reasons as it was to understand the retail environment by engaging directly with customers. Feedback meetings were held on a monthly basis between retail and marketing staff. The Geneva store was run by Caran d'Ache employees. Other concept stores were franchised with partners in Berlin and Tokyo.

Governance and Transition to Nonfamily Management

With the retirement of Jacques Hübscher, Jr., in 1997 as CEO, the long reign of three generations of Hübschers as CEO came to an end. For the first time, the company was to be managed by a CEO without any connection to the three owner families. The transition proved difficult: to find a person who would fit into the family business and still assume the role of the CEO was not easy. After the first 2 years, the then CEO was replaced and Silvio Laurenti was appointed CEO in 1999. Achieving considerable success with a challenging strategy, Laurenti remained until his retirement in 2008.

A new CEO joined only to leave again in 2011. To fill in temporarily, Laurenti came back out of retirement until a permanent successor, Jean-François de Saussure, was ready to take on the CEO role. Although without relevant industry background, de Saussure had previously worked at a family-owned company in the region which prepared him for the intricacies of managing a firm with three owner families.

This was also the time that Jacques Hübscher, Jr., after serving on the board for 30 years, chose to step down and his daughter Carole Hübscher assumed the role of chairing the board. She had been a board member since 2002, working closely with her father. Her marketing experiences included Swatch and a brand management firm prior to joining Caran d'Ache.

Governance at Caran d'Ache rested with the board of directors with representatives of the three owner families: two from the Hübscher family and one each from the Reiser and Christin families. In addition, three external board members with relevant experience in finance, innovation, and luxury branding complemented the board.

Chairwoman and representing the fourth owner generation, Carole Hübscher felt it was important for the owner families to maintain a passion for the business and not just play investor roles. She considered private ownership a substantial advantage for the independence of the firm. Financial independence allowed the continual pursuit of the strategy Caran d'Ache had adopted for decades, which was not to take any shortcuts on quality for the sake of short-term financial gain. To pass the passion for the business on to the next generation, the owner families were already engaging the fifth generation and establishing guidelines, or a charter, on how the next generation could engage while avoiding potential conflicts.



Exhibit 26.9 Caran d'Ache product

Company Profile 10: Kuhn Rikon AG¹⁶—Cooking Up a Storm! Global Leader in Steam Pressure Cooking for Home Use

The Cooking Invention Turned into a Global Business

The Kuhn Rikon company, over 90 years old and managed by the fourth generation of the Kuhn family, was founded in 1926. Its origin was an old business making cooking pans which had been installed in 1899 on the site of a previous spinning mill going back to 1819. The company developed the well-known Duromatic pressure cooker and made this the cornerstone of its business with exports into many corners of the world. After expanding into cooking utensils and gadgets, the Kuhn Rikon business grew to about 240 employees (2017) and sales around CHF 60 mio.¹⁷

¹⁶This profile was written by Jean-Pierre Jeannot (Professor Emeritus Babson College [USA] and IMD Institute [Switzerland]) on the basis of a company interview and publicly available information. Copyright©2019.

¹⁷As a privately owned business, the company did not publish any sales figures. Estimates by case author.

Heinrich Kuhn Acquires the Coppersmith Workshop in 1926

Originally, a spinning mill in Rikon along the Töss river, the mill was repurposed by the Kindlimann family who installed a tin and coppersmith workshop manufacturing cooking pans in copper and then steel for what were then still mostly wood-fired stoves in Switzerland. Named by the villagers “Pfanni,” the business fell on hard times and following a fire in 1924 it was sold. The new owner passed away soon afterward and Heinrich Kuhn seized the opportunity to acquire the workshop in 1925.

Heinrich Kuhn (1878–1932), a son of farmers, first had completed an apprenticeship as a metalworker followed by studies in mechanical engineering at the Polytechnic Institute in Winterthur. After graduating, he left Switzerland around 1910 to pursue a career as a mining engineer in the Alsace region developing process machinery. With the mining industry in decline after WWI, his wife’s family was eager to get the Kuhn family back to the Töss valley. At the age of 48, Heinrich returned to Switzerland and invested his life savings to buy the factory in Rikon, borrowing the rest from his in-laws.

Heinrich Kuhn soon realized that the rapid change from wood-fired to electric stoves would require a different kind of pan. On a wood stove, the shape of the bottom did not matter. With the emerging electric stoves, absolute flatness of a pan’s bottom was essential. Being an engineer, Kuhn knew how to roll flat walls from aluminum sheets. Aluminum, then still a new metal, provided excellent heat conductivity essential for electric hot plates. Kuhn branded his new pans “Duro.” Unfortunately, Heinrich Kuhn died in 1932 at the age of 55 of a brain tumor leaving the factory to his two teenage sons, 18 and 14 years old, respectively. The business had grown to some 50 employees.

The Second Kuhn Generation Steps In

At the time of his father’s death, Henri Kuhn (1914–1969) was barely 19 years old and a short time before his maturity exams. He was interested in art and had actually planned to study. Young Henri instead left school and joined the company as a controller with coaching provided by two of his uncles. Henri stayed with the company as manager until 1969 when he died at the age of 55. He had four children, a son Hans-Heinrich and three daughters.

Jacques Kuhn (1919–2016), the younger son of the company founder Heinrich, was allowed to pursue his studies at the ETH Zurich graduating in mechanical engineering. Completion of his degree and the end of WWII fell into the same time period. Jacques went to the USA to pursue further studies at a US machine tool making institute learning about the formation of metal sheets. He attended the Studebaker School for metal forming and also used the time to visit many cookware manufacturers in the USA. During his many factory visits, he became acquainted with the assembly line production process. In his letters to home, he wrote 90% about machines and 10% about himself and how he was doing. He ordered machines

in the USA to be sent to the factory in Rikon and joined the business in 1947. Jacques did not marry until very late in his life and did not have any children.

The Launch of the Duromatic Pressure Cooker

When Jacques returned from the USA, he concentrated on the company's technical development and manufacturing, whereas his older brother Henri became the marketing and communication expert of the firm.

The Duromatic was launched in 1949, a pressure cooker with a spring valve for pressure release. This became a defining product still accounting for some 20% of company sales (2017). The product resulted from a chance meeting between Jacques Kuhn and an inventor from Zurich. Realizing the value of this idea, Kuhn Rikon took out a license and combined it with a bayonet-closing device designed by Jacques. A joint patent was issued for the closing device and the valve, both designed to make the use of the Duromatic both simple and safe.

Before the Duromatic could be produced, the company had to solve the delicate manufacturing problem of the safety valve. The valves, requiring small gaps, were eventually sourced from companies with experience in part production for the watch industry.

At the time of the Duromatic launch in Switzerland, there were 8 other competitors with their own versions of pressure cookers. In 1949, Kuhn had zero market share and then saw its shares rise to 80% for Switzerland over the years. Brother Henri was looking after the marketing of the new product. Since its introduction, millions of Duromatic cookers and follow-on models had been sold all over the world. Pressure cookers became popular because they saved considerable amount of cooking time compared to the traditional alternatives.

Developing Durotherm in 1975

Kuhn Rikon innovated and launched additional cookware beyond the classic Duromatic. The year 1975 saw the launch of the Durotherm which combined the function of a cooker with that of a serving hot pan. The idea stemmed from Jacques Kuhn's own cooking experience as a bachelor. He not only cooked for himself but also for invited guests, ending up cooking in the kitchen, while his guest enjoyed an aperitif. Eager to change that sequence, he was looking for a cooker which let him first cook the meal, then enjoy an aperitif with his guests, and finally serve a dinner that had been kept warm in a special dish. The Durotherm cooker exactly served this purpose and could keep food warm for up to 2 h. For the heat keeping quality of the cooking and serving dish, Jacques was inspired by the Swiss Army field kitchen equipment which was specifically designed to keep food at serving temperature. He also collaborated with a welding machine supplier to create a specially designed welding seam. The Durotherm was successfully launched in Switzerland and abroad.

Innovations Contributed by the Third Generation

Wolfgang Auwärter-Kuhn joined the company in 1984 as joint manager with Hans-Heinrich Kuhn, the son of Henri. Auwärter was a PhD physicist who understood research processes and materials. He expanded the development team by hiring another physicist (*Physicists are open to all disciplines*). The development team aimed at controlling and measuring all parameters inside the pressure cooker, such as internal pressure, and adding special sensors and timing devices. The idea was to develop an intelligent pot for automatic cooking. The company collaborated with other larger firms from the field of cooking appliances to realize this idea. Technically, the main issue and difficulty were to develop a communications technology for the pot that was compatible with all ranges or stoves, as no such standard interfaces existed. One company gave up before the product was finalized, and another wanted exclusivity on sales. Despite all challenges, the Duromatic “Timax,” a Cadillac of cookware, reached the market with a price of CHF 300 per unit and was launched in 1994. Over the following 6 years, some 60,000 units were sold.

The latest generation of innovations followed in 2011 when Kuhn Rikon launched its Duromatic Relax Powersteamer that finally allowed for targeted fully automatic cooking with steam pressure. This unit was intended to be fitted into any modern kitchen and had its own water supply. Different compartments and a touch panel allowed for different and easy cooking time selections for several trays of food. The equipment was priced at CHF 4000, substantially above any other cooking products marketed by Kuhn Rikon.

Entry into the Kitchen Gadget Business

Like so many other innovations, they sometime arrive unannounced at your doorstep. As the story goes, in 1982, an inventor from Biel/Bienne showed up one day at Kuhn Rikon with a design for a can opener that cut underneath the can’s rim and avoided common injuries from opening a can. The Kuhn Rikon sales manager saw potential in the idea and the company set up a licensing agreement. The product found quick acceptance, and the Swiss retail chain Coop ordered 100,000 units. Through a friend with sourcing contacts in China, the can opener was improved in 1998 such that after cutting one could put the lid back on. Now Tupperware, direct marketing giant in the USA, adopted that product. The connection to sourcing the can openers in large quantities from China eventually led to all kitchen gadgets and utensils to be sourced from there. Sales volume also expanded so that by 2018, only half of Kuhn Rikon sales volume was accounted for by cookware and the other half consisted of kitchen gadgets and utensils, essentially doubling the size of the company.

Kuhn Rikon launched about 30 new gadgets and kitchen utensils annually. Because of its reputation and market presence, the company received two to three product ideas each month. Key was to keep the expectations of inventors realistic. All ideas were triaged by a development team consisting of product managers from

the USA and Europe, sales input, and of course the development team that had to turn the idea into a final product.

Kuhn Rikon learned that kitchen gadgets and knives were a completely different business from cookware. Color and fashion were important in this sector. To keep abreast, its design team traveled three to four times a year to China and involved not only designers, but also suppliers and TV channel representatives in the determination of what might sell.

Difficult Experience with Acquisitions

Kuhn Rikon had two experiences with acquiring related or competing companies in Switzerland. In both cases, difficulties eventually lead to a dissolution of the arrangements.

In 1988, Kuhn Rikon agreed to acquire 60% of the shares in Spring, a company based in the neighboring Canton Thurgau, specializing in the cooking-at-the-table segment, with a strong retail presence and a business to catering companies. From the Kuhn Rikon point of view, integrating the Spring product line and using it as a production base made strategic sense. The share purchase became possible because of the ownership structure of Spring, fully owned by two brothers, only one with children, and the other brother wanting to sell. Kuhn Rikon ran into governance issues due to the fact that 60% ownership was not sufficient to deal with company liquidation or capital increase, where Swiss laws required 2/3 majority. Eventually, the collaboration and holdings were dissolved in 2000.

Financing of the transaction was also made difficult as the banks, initially willing to separate the buildings from the business transactions, granted 100% mortgages on the buildings, only to later change their minds requesting a reduction of the mortgages to 60% of building value. Kuhn Rikon was in the midst of installing a major new production system, a large investment. The issue was resolved with the help of external friends. This experience led company management to say “No more banks” when it came to major financing. These difficulties also led to tensions within the family constellation, with co-managing director Hans-Heinrich Kuhn, who was co-managing the company jointly with Wolfgang Auwärter, leaving the company and moving to South Africa.

Another opportunity arose in 1999 when Sigg, a Swiss competitor of Kuhn Rikon, was put up for sale by its owner, Alu Menziken, a Swiss aluminum producer. Sigg was strong in drink bottles, cookware, electrical appliances, and raclette ovens, all products that would have led to an expansion of the Kuhn Rikon product line. The Sigg business had invested in a completely new production line and factory that did not perform reliably due to technical complications. Kuhn Rikon did not come to an acceptable agreement with the owners, and Sigg was sold to a private investor. However, Kuhn Rikon acquired some equipment and staff, as well as the use of the Sigg brand. A conflict arose over the use of the Sigg brand with Sigg company management, and Kuhn Rikon eventually had to give up the use of Sigg brand.

Production Footprint

Production at Kuhn Rikon's plant in Rikon focused on its long-established cookware business. This product line, accounting for about one-third of total sales, was entirely produced in Rikon on a modern, custom-designed and robot-enhanced production line. Other cookware, such as frying pans, was sourced from a reliable Italian supplier.

Kuhn Rikon kitchen gadgets and utensils, accounting for about half of company sales, were instead conceived and designed in Switzerland but produced offshore in China. Management did not think the company could be competitive with many large international companies with products from a high-cost Swiss manufacturing base.

As the company saw it, the success and profitability of the gadget and utensils business was an important contributor to overall company profitability and as a result also helped support the traditional cookware business produced in Switzerland. Still, there needed to be tight control over part of production.

When Kuhn Rikon experienced difficulties hiring production workers in the early 1960s, the company simply built factory housing next to its plant operations. However, even that did not alleviate its recruiting problems. When a large group of Tibetan refugees arrived in Switzerland, the company offered its housing to them and successfully managed to recruit them. It even helped to build a Tibetan monastery in the area. Today, some 14 different nationalities were represented among its workforce, including descendants of the initial Tibetan refugees. The company offered regularly three to five apprenticeships. Talent hiring was eased when a new S-Bahn connecting Rikon on a direct line to Zurich main train station was opened.

Building International Markets

Kuhn Rikon had long exported its products to international markets and was present in some 40 different countries. The company operated subsidiaries in the UK (since 1980) and Spain (since 1982), both for sales and marketing. Its US subsidiary opened in 1988 engaged in product management besides sales and marketing support.

One of its major exports markets had been Iran, where, due to the high altitudes and a preference for meals such as lentils that demanded long cooking times, Kuhn Rikon had built up a strong position. The Iranian revolution in 1979 changed all of this, and its main distributor fled to California where he tried to build up a business again. A former apprentice from Kuhn Rikon, who had also immigrated to California, connected with this new export drive and quickly realized that sales success in the USA depended on an ability to demonstrate the cooking performance. A deal with QVC Cable Network for direct selling met with great success, eventually launching the direct selling drive for many of Kuhn Rikon products in the USA and elsewhere.

Marketing Through Multichannels

If you separate production from marketing, through outsourcing, you have to be very good at marketing stated a company executive. Kuhn Rikon aimed at *selling stories, not products*. Its success in brand marketing was recognized by the Swiss Marketing Association. Lack of brand power on an international basis had to be compensated by being quicker in innovations.

On the distribution side, Kuhn Rikon practiced multichannel marketing. The traditional retail channels such as Migros in Switzerland or William Sonoma in the USA were augmented by direct sales on TV shopping channels. These TV programs were particularly strong in the UK, Germany, and the USA and allowed for a demonstration of the Kuhn Rikon products. Online shopping platforms, such as Amazon, and Alibaba Tmall where independent distributors stocking Kuhn Rikon products manned their own “store,” also became increasingly important. Kuhn Rikon did not sell directly on Alibaba.

Impact of Government Regulations on Swissness

The debate about what constituted *Swiss Made* was of considerable import to Kuhn Rikon. Since outsourced products, produced outside of Switzerland, could no longer be advertised as *Swiss Made*, the company, after several false starts, moved toward differentiated labeling of its product lines: Cookware produced entirely in its Rikon factory continued to be labeled *Swiss Made*, with authorized use of the Swiss flag. The company’s kitchen gadget and utensil line could no longer be sold under that label, even if they were brought back to Switzerland for packaging. Like other firms, Kuhn Rikon changed to label these products *Swiss Designed* but had to forego the use of the Swiss flag on its packaging.

Ownership and Governance at Kuhn Rikon

When company founder Heinrich Kuhn acquired the factory site in 1926, his wife’s family, the Boller family, assisted with financing so that Heinrich could acquire full ownership of the factory. When he died in 1932, his wife inherited ownership, which was transferred in equal portions to her sons Henri and Jacques. Henri, who also died early at 55 in 1969, passed on his 50% stake to his wife (25%), and the other part in equal shares to his 4 children.

The situation was different regarding the 50% ownership of Jacques who did not marry until very late in life and did not have any children. He bequeathed his 50% stake in the form of a preinheritance to Henri’s daughter Rosanne who was married to Wolfgang Auwärter, later to become CEO of Kuhn Rikon. Combining her two inheritances led to a majority ownership of the Auwärter-Kuhn branch of the family. *You must have somebody with a clear majority* believed Auwärter.

When Auwärter stepped down as CEO, and later as board chair, the company adopted a rule of separating the CEO position and board chairmanship. A family member could hold only either one of the two positions. Retirement age was set at 70 for board members and at 65 for executive positions.

After stepping down from the board, Auwärter’s daughter Dorothee Auwärter, a lawyer by training, assumed the position of board chairwoman. An external manager with a strong background in marketing was engaged as CEO.



Exhibit 26.10 Kuhn Rikon product line

Company Profile 11: Ricola¹⁸—From Local Confectionary to Global Herbal Candy Champion. From Hobby to Global Business

Started by a Young Entrepreneurial Baker

When a 23-year-old local young man, Emil Richterich, acquired the town bakery in 1924, few people in the town of Laufen (Canton Basel Land) would have guessed that this venture would spawn a world-renowned company and one of the largest employers in the Laufen Valley.

In 2017, the Ricola company had sales of about CHF 300 mio and employed over 400 people worldwide. The company was still owned and managed by the Richterich family, descendants of the founder now in the third generation.

Leveraging Bakery and Confectionary Skills

Emil Richterich (1901–1973) was the son of the local schoolhouse janitor, attended local schools, and finished his apprenticeship as a baker and confectioner. It was said that Richterich, working hard, often felt tired, and began taking herbal baths to relax. He began to experiment with herbs as a hobby before he actually turned it into a business. As a master baker, he knew how to deal with sugar, thus creating herbal sweets, which he sold regionally and directly to retailers. Over time, Richterich developed as many as 80 different herbal sweets. In the end, it was the original herb drop that sold best and Richterich began to focus on it.

Starting A Herbal Sugar Candy Business

In 1930, Richterich formally started his candy business, Richterich & Compagnie, in the same space as his bakery. As he continued to experiment and develop different herbal sugars, he created a mixture of 13 different regionally sourced herbs. With these 13 herbs from the local valley, he created the recipe that led to the specially formed drop with its distinctive square shape. This mixture was still at the core of the company's products today. The exact nature of the mix has remained a secret.

Growth of the business required Richterich to build a warehouse for his herbs and candies situated in a quarry outside of town, and production had to be moved into temporary facilities in 1945. In 1951, the company's continued growth required a yet another move to a new location outside the town of Laufen. At that time, production at the old bakery in Laufen was terminated.

¹⁸This profile was prepared by Jean-Pierre Jeannet (Professor Emeritus Babson College [USA] and IMD Institute [Switzerland]) on the basis of a company interview and publicly available data. Copyright©2019.

Branding the Herbal Sugar Candy “Ricola”

Richterich encountered a problem of brand confusion. It so happened that in the same town of Laufen, another confectioner, Oskar Richterich, unrelated to Emil Richterich, also marketed his products directly to retail stores in the region. Tired of being asked “Which Richterich are you?” all the time, Emil Richterich decided in 1948 to change the name of his company, using the first syllables of **R**ichterich, **C**OMPagnie, and **L**Aufen to create **RICOLA**. Since he had simultaneously reduced his product line to just 2 or 3 bestselling ones, the new company name became the brand name for his herb drops.

Ricola’s Global Expansion

Early on, founder Emil Richterich, and later his son Hans Peter, frequently traveled abroad. They visited trade fairs, such as the one in Cologne, to look for interested distribution partners. Many contacted the company directly and offered their services. Those distributors were crucial to Ricola in the early growth phase of the business, when production limitations were a constant concern. Relying on partners who took responsibility for distribution in their respective markets allowed Ricola to focus on its production bottlenecks.

In the 1960s, the major export markets were France and Germany. In those countries, and in Switzerland, Ricola became the market leader in its category. In the 1970s, Ricola initiated considerable marketing activities in Japan, Hongkong, Taiwan, and Singapore. In 1980, the subsidiary Ricola USA took up operations, but Ricola had been present in the American market already since the 60s. Ricola’s presence in China goes back about 30 years with a strong track record and its brand well-known there.

By now, Ricola was exporting 90% of its production and had converted a number of local operations into subsidiaries, mainly in the USA and Italy. In terms of volume, the leading markets were USA, Germany, France, Italy, and Switzerland. Major changes also took place in the Chinese markets where the company changed from its initial long-running export relationship with a Swiss-based trading company to deal directly with a Chinese partner. This resulted in a substantial expansion of its point-of-sales across all regions of China.

Nurturing the Ricola Brand

Ricola’s brand values were focused on the consumer. The company summarized them as functionality (good for your throat), enjoyment (in terms of good taste, not as a medication), and Swissness for its heritage. These three values were essential for the Ricola brand expression, and if any given product did not exhibit those three, it could not be a Ricola branded product.

Maintaining the core values at Ricola was the responsibility of brand management. Originally, the company had relied mainly on its distribution partners to position the brand in the various countries. Over the past years, brand management was increasingly centralized to avoid divergent Ricola brand interpretations by different partners and to be able to mount a greater number of global brand marketing campaigns.

A special role was played by social media and Ricola market research engaging consumers on a daily basis to take the market pulse. In fact, up to about 2005, the company had little direct consumer contact. The arrival of social media changed all of this. The Ricola brand values were focused strongly on the consumer, and social media would alert the company to emerging shifts in customer preferences. Ricola could then quickly adapt its product assortment.

Focusing the Ricola Product Portfolio

Although the Ricola assortment included about 300–400 SKUs, it remained focused on its core herbal candy business segment. The assortment consists of two types: sugar and sugar-free (sweetened with Stevia or artificial sweetener). The company offered some 25 different tastes, but not all were sold in all markets.

Aside from taste segmentation, Ricola offered its products in a wide variety of packaging alternatives that substantially added to the number of SKUs offered.

Assuring Sufficient Herb Supplies

By the early 1980s, the success of Ricola sales began to outstrip its supply of herbs, which up to that time were mostly from the local area. The company launched an appeal to Swiss communities and schools, but the result was disappointing. Eventually, the company connected with over 100 contract herbal farmers in the Swiss Jura and mountain regions, encouraging them to plant the herbs on contract with Ricola providing the seeds. The total plantation area amounted to an equivalent of about 124 football fields and yielded 1400 tons of fresh herbs each year. Herbs were dried immediately after harvest at their plantation areas, then put in bags, and shipped to the Ricola herb center for further sorting, drying, cleaning, and mixing with other ingredients.

Demonstrating its herbal competence, Ricola created five public herb gardens in the Swiss mountains to showcase the 13 base herbs.

Dedicated Herb Processing Operations

The Ricola herb center was a large, dedicated facility where the various herb processing steps took place. From the dried herbs, natural essences were extracted and mixed with other ingredients. This mixture was then cooked and molded into

drops and pearls and left to cool. The entire process took place at the company facilities in Laufen, Switzerland.

Processing the dried herbs to create the 13-herb base mix was seasonal and extended over 3–4 months only. The company, to assure a continuing flow for further production, stored herbal extract for several months. Each year, Ricola processed about 250 tons of dried herbs.

The processes were highly automated. Although Ricola acquired its equipment from external suppliers, the extraction method and tying each step into a continuous flow were proprietary and internally developed. This meant that a potential competitor acquiring the same equipment would still not be able to arrive at the same results. In 2017, Ricola produced 7 billion of individual drops a year.

Ricola remained attached to its location in Laufen for the entire production. Production was organized into two long shifts, and most of the employees were recruited locally. The efficiency of the production operation, including automation and using robots, allowed the company to compensate for the higher Swiss salary costs compared to neighboring countries.

Ricola Distribution and Logistics

When Switzerland opted to stay outside of the European Economic Area in 1992, Ricola, in order to protect its important European markets, built a small packaging facility in Mulhouse, France. Manufacturing of the herb drops, however, remained based in Switzerland.

Patrons of Arts and Architecture

Starting in the 1940s, when his company began to flourish, founder Emil Richterich developed contacts with local artists and began a small art collection, which he displayed in his family home in Laufen. In the 1950s and 1960s, he expanded the scope of his collecting activities to include internationally known contemporary Swiss artists. Many of the works of art were on display in company buildings. After the death of their father, his sons Hans Peter and Alfred jointly continued to enlarge the collection. Alfred Richterich, who was particularly interested in the collection, was instrumental in creating a foundation in 1975 that would become the corporate Ricola Collection. Many of the works owned by the collection remain on display throughout the many company buildings.

When Alfred Richterich, who also took an interest in urban planning for the town of Laufen, decided to invite a group of architects to Laufen and, at the suggestion of a Basel art dealer, Alfred included a young architect, Jacques Herzog, partner of the recently founded firm Herzog & de Meuron. On the basis of this initial contact, Alfred Richterich tasked the young architecture firm with the renovation of his family home, completed in 1980. This led to a series of follow-up projects for the Ricola company, at present a total of seven buildings in Laufen and Mulhouse. It was

the view of the Richterich family that the top-quality drop manufacturer of the world had to be located in top-quality world-class buildings. Herzog & de Meuron was to become one of the premiere architecture firms of the world, renowned, among other projects, for the Tate Modern in London.

Ricola Foundation

In 2010, Ricola created the Ricola Foundation aimed at enhancing society's understanding of the natural and cultural foundations of human life. Endowed with a starting capital of CHF 1 mio and continuously supported by the company and the Richterich family, the Ricola foundation concentrated its resources on the support of COLOSS, a scientific network that coordinated worldwide research into understanding the increasing loss of honeybee colonies. Other projects include research into clay architecture and crop research. Governance lies in the hands of a small board composed largely of Richterich family members.

Ricola Remains a Family-Owned Business

Ricola remained a family-owned company with shareholders from the Richterich family only. Emil Richterich, the company founder, passed away in 1973. His two sons, Hans Peter and Alfred, inherited the company. Hans Peter assumed the role of CEO, whereas Alfred concentrated on the various cultural foundations supported by the Richterich family and Ricola company. Felix Richterich, son of Hans Peter, represented the third generation and assumed the CEO role. There was already a member of the fourth generation, Raphael Richterich, the son of Felix, in the business.

Governance at Ricola

The Richterich family employed a two-stage legal structure in the form of a holding company that owned the Ricola AG herbal candy business. Also, part of this holding were the non-Ricola assets, such as the Ricola Foundation, the art collections, and its social action operations.

At the Ricola AG level, the company had a dedicated board of directors that ran according to modern or best practice governance principles. The board was small, included two members of the Richterich family, including Felix Richterich (CEO), and two external board members not related to the Richterich family. Half of the board members were women.

Company Profile 12: Jura Elektroapparate AG¹⁹—From Generalist of Kitchen and Household Appliances to World Champion in Espresso Machines for In-Home Use in 75 Years. “The Best Cup of Coffee at the Press of a Button”

Started by a Single Entrepreneur

When Leo Henzirohs began manufacturing electrical home appliances at the age of 29 in the small town of Niederbuchsiten (SO) in 1931, he would never have dreamed that his business would someday employ hundreds of people in Switzerland and abroad, market more than 300,000 Espresso machines a year, and become world market leader in the premium in-home segment for a product the company did not even begin to market until about 50 years after its start. How could this happen?

Founder Leo Henzirohs was best described as a tinkerer. Electrical engineer by training, he rebuilt his own used car, was one of the first users of radios which he sold to farmers for whom he also installed electricity in their stables. He saw opportunity in the many tasks of a typical household at a time when homes were recently electrified. Naming his company Jura in 1933, he launched his first electrical coffee machine in 1937. Starting with just 3 employees in 1933, by the outbreak of WWII in 1939, Henzirohs had already 70. All of this growth during the 1930s took place under trying economic circumstances. After WWII, the company benefited from the overall economic expansion in Switzerland.

After a Disastrous Fire a Need to Start All Over Again

Disaster struck in 1953 when the company’s premises were destroyed by fire. Henzirohs rebuilt the company with a loyal team of hard-core of employees; many of those would later become senior executives in his company. One of them, Oswald Müller, later served as CEO and Chairman of the company. The product line was expanded and Jura even branched out into manufacturing refrigerators and washing machines for the retailer Migros. Majority of sales were to Swiss customers.

A major breakthrough occurred in 1955 when Jura exhibited Europe’s first steam iron at the Hanover Fair in Germany. Throughout the 1950s and 1960s, Jura was the only company offering steam irons and sales continued to climb. By 1970, Jura dominated the Swiss steam iron market with a share of about 75%. But competitors from Germany were catching up, and Jura lost its exclusive position as sole supplier of steam irons, its best-selling product.

¹⁹This company profile was written by Jean-Pierre Jeannet (Professor Emeritus Babson College [USA] and IMD Institute [Switzerland]) on the basis of a company interview and publicly available information. Copyright©2019.

Origin of the Espresso Machine Opportunity

As early as 1937, Jura introduced its electric coffee percolator, which remained part of its portfolio for a long time. In 1976, Italian entrepreneur Sergio Zapella visited Jura to present his espresso coffee machine for in-home use. His company, SAECO, was the first to develop espresso machines for in-home use. Up to that time, the market was of the opinion that good espresso could only be made by professional machines in restaurants or coffee bars. When discussing the possibility of adding this SAECO machine to the Jura product line, the company's own marketing team considered the machine too expensive to produce. After testing the espresso machine in the Henzirohs home, and by some company managers, a consensus developed to import the Italian machine for the Swiss market and to assign distribution to Jura Interelektro, owned by Jura. In the process, Jura also helped improve the SAECO machine in terms of quality and functionality and in return was granted exclusive distribution rights for the Swiss market. The effort was successful, and by the mid-1980s, sales of the espresso machines had already surpassed those of steam irons.

1982 to 1991: A New Team Takes Over

When founder Leo Henzirohs retired from the board in 1982, Oswald Müller succeeded him as chairman. The company had about 450 employees at that time. In 1984, when Henzirohs died, Jura sales passed CHF 71 mio and employment reached 500. A year later, sales passed CHF 75 mio, but the first signs of lower-cost European competition signaled impending difficult periods for Jura with its once-dominant share in steam irons coming under increasing pressure. By the end of the 1980s, Jura entered a difficult period of stagnating sales, declining profits, and even losses in some years.

It was during this time that Emmanuel Probst, then just 28 years old, joined the board of directors of Jura in 1985. His father, Leo Probst, was Jura's first employee and had become its technical director.

As Oswald later described, he and his senior managers, all approaching retirement, were intensively looking for a new CEO to take over. After unsuccessful appointments of external managers, the search company suggested to Oswald to take a closer look at Emmanuel Probst, already on their board, before he would be hired away by some other company. Probst, who had studied at the University of St Gallen and gained early marketing experience at Procter & Gamble and Baxter, a medical company, then joined Jura in 1991 on a fulltime basis. Later on, Emmanuel Probst was also to become Oswald Müller's son-in-law.

1991 to 2015: Period of Transformation

Now in charge, Emmanuel Probst tackled the many issues at Jura that arose from an extensive product portfolio and high business complexity. Probst unleashed a process of transformation that was to take about 15 years. He initiated a focus on espresso machines. He saw this novel market as one where the rules of the game had not yet been defined. Although Jura kept marketing SAECO machines in Switzerland, over the next 2 years the company developed a completely new espresso machine of its own design, IMPRESSA 500, also aimed at the in-home market. This model was the first machine on the market that allowed users to prepare coffee according to individual preferences. The machine came equipped with features such as a variable brewing unit, a display dialog system and an automatic switch-off function to save energy.

Production of the new IMPRESSA 500 was not entrusted to its traditional Italian supplier. Jura always feared that SAECO might be sold and thus they could lose the distribution rights for Switzerland. Furthermore, Jura wanted to have its own exclusive design. As a result, Jura struck a deal with Eugster/Frisomag, a Swiss contractor with production experience for home appliances for other companies and no desire to enter into the branded market on its own account.

Results were not long in waiting. Sales rebounded in 1993, and over the following 10 years, Jura introduced additional lines of fully automated machines, leading to sales passing the CHF 225 mio mark in 2003 and reaching CHF 260 mio in 2004. By 2016, sales of Jura stood at CHF 420 mio and 350,000 machines.

A Focus Strategy on Multiple Levels

Several elements of Jura's business strategy were instrumental in achieving this rapid growth and global expansion. Examining the key elements that contributed most to Jura's success, the observer is struck by the fact that, yes, the company "focused," but this focus took place at several levels, ranging from the product line, the marketing segment, the value chain, its branding strategy, its innovation approach, as well as its sales and service models. In each of these areas, the company focused further on particular subtasks within each element.

Focusing the Product Line

Starting initially as a company that offered anything that could be electrified in the kitchen or the household, there were nevertheless different elements that took the lead at different times. First came the steam iron in the mid-1950s, then the coffee machines in the mid-1980s, but all the other products continued to be offered. Not until Probst took the helm of the company, was a decision taken to eventually stop everything but espresso machines. Jura focused on automated coffee machines for home use starting from ground coffee only, i.e., the bean-to-cup types. Other

competitors, including SAECO, de Longhi, Krups, or Nivona, all of them larger in sales than Jura, also offered capsule-based machines, and some branched into small home appliances beyond coffee. This transformation to a single focus, however, was not completed overnight: Jura finally stopped producing steam irons in 2008 only.

Focus on In-Home Use as Target Market Segment

When it came to the application segment, Jura focused strictly on the in-home-use segment. Jura had consistently stayed away from institutional markets, such as hospitals, the restaurant market, offices, or canteens. More recently, some expansion has been observed into the areas of small and selective offices types, such as for lawyers.

Within this home segment, the focus was on the top segment of in-home use. Jura aspired exclusively to offer the most demanding machines and left the low-priced machine segment to competitors. As such, Jura was the only player in this field that operated such a clearly articulated segment strategy.

Focus on Selective Steps of the Value Chain

Probst was fond of saying that *No one can possibly run the entire distance alone and expect to reach their goal. There are runners for every stage of the journey.* Using this analogy for Jura, he concluded that the company could not, on its own, design and launch a new line of espresso machines while at the same time ramping up production. As a result, Jura entrusted the production of its new automatic espresso machines to a partner, Eugster/Frismag, located in Eastern Switzerland, to become its exclusive contract supplier. Supplier only, as product design and downstream marketing strategy remained the full responsibility of Jura and its staff. Eugster/Frismag, a company larger than Jura with more than 2000 employees, was thus shouldering the entire production capacity investment leaving Jura to use its resources for the downstream steps of its value chain.

Controlling Design and Features

All features of Jura machines originated, were controlled and driven by the company. Its CEO, Probst, played the leading role in this process as he frequently traveled to international sites. He was fond of visiting automobile shows, and he appears to be influenced by modern auto design features. The F90 model launched in 2000 was considered the model that most defined the design of future Jura machine generations.

Beyond design, other partners were chosen for selective features. One covered the water filtration mechanism installed in every Jura machine. This supplier/partner, Acquis, a Swiss-based filtration specialist, designed the CLARIS filter cartridge

especially for Jura machines in such a way that the resulting coffee would be consistent in quality independent of the water source which might differ from region to region. Jura did not believe that it would make sense to develop its own filter. Instead, the company aimed at collaborating with the best in the field and having that partner produce a custom-made filter for its machines. According to Jura, coffee was 98% water, which should not be too rich in minerals, chlorine, or other unwanted ingredients. A perfect filter would assure the water remaining in the right range required for excellent coffee. The same approach was used for other machine elements.

The role of design was core to Jura's strategy. The company was at the forefront of seeing a trend where coffee machines became an aspirational product for high-end customers. Modern kitchens increasingly became open and integrated into the living space, and an attractively designed coffee machine would be part of the total look.

Perennial Innovation

Constant and frequent innovation was a main pillar of Jura's strategy. Because competitors could quickly imitate espresso machines features, the company was constantly improving on its machines. The intent was to stay one model generation ahead, a moving target requiring perennial innovations. This led to an innovation rhythm of new machine models every year, and with new model sales consistently representing a major part of annual sales. Many of Jura's staff at its head office in Niederbuchsiten were devoted to this effort.

Marketing and Branding: Building the "House of Jura"

While its espresso machines were subjected to imitation and copying, Jura believed that a strong brand was much more difficult to copy. Around its product line focused on best coffee, most attractive design, and ease of use, the company built what it called "The House of Jura" combining a strong brand, controlled distribution, and outstanding service. Since 2006, Jura collaborated with the Swiss tennis star Roger Federer as main spokesperson for the brand. Jura saw a strong brand image as security for its customers that the product would live up to expectations. Jura's worldwide identity helped to strengthen the brand wherever customers traveled, be it for business or for leisure activities such as golf. The global identity was not created for the sake of standardization but rather to achieve consistent quality and to facilitate customer perception of the Jura brand.

Building Selective Distribution and Geographic Expansion

Distribution was an important element in the “House of Jura” strategy. The company did not want to be placed as one among 20 other coffee machine brands just anywhere on a retailer’s shelf. Therefore, the company strictly controls the point-of-sale (POS) environment, from controlling dealer needs, controlling how customers were to be treated and training how to sell the Jura line. This focus, Jura believed, could only be achieved with a single line of espresso machines on display. Jura had thus reduced the number of selling points globally from at one time 11,000 POS to presently only about 7000 POS. At the same time, efficiency per POS substantially increased. In 2006, Jura opened its first hospitality center for customers in London, as well as in Singapore and Perth, Australia. Global distribution was achieved by a combination of company-owned sales subsidiaries in key markets in Europe, North America, and Asia, combined with national dealerships selling through retailers. Although distributor sales accounted for only about 30% of global Jura sales, this segment experienced the fastest growth. As a result of its globalization, sales in Switzerland accounted for only a small percentage. With 2016 Sales of CHF 420 mio, Europe accounted for about 80%, and 20% of sales were to non-European destinations.

Intensifying Service and Jura World Exhibit

At its main site in Niederbuchsiten, Jura created an exhibition entitled “Jura World of Coffee” that attracted thousands of visitors each year. Also, on the same site, a new service center was located, for consumers to bring in their own machines, have them electronically diagnosed on the spot and scheduled for any repairs necessary. For customer ease, there were 24-h drop-off and pickup locker facilities. The company was still experimenting how to make this extensive service capability a self-supporting part of the company.

Stability in Ownership and Governance

Jura was a privately owned and did not publish any details on ownership. It was known that Leo Henzirohs and his wife were for a long time the only shareholders in the company. After the rebuilding following the fire in 1953, Henzirohs had some of his key staff participate in the share capital. Upon his retirement, the Henzirohs placed the majority of their holdings into a foundation, as they did not have any children. Today, Jura was a closely held corporation with few shareholders, and ownership had not substantially changed over time. This stability in ownership and governance, combined with Jura’s success, had allowed the company to remain financially independent and fund its development from internal resources. According to one insider, the company was using banks for its treasury and transaction operations, not for lending or credit purposes.

GIGA-Linie



GIGA 5

Z-Linie



Z8

J-Linie



J800

E-Linie



E800

A-Linie



A700

ENA-Micro-Linie



ENA Micro 90



Cool Control Wireless
0.6 l



Tassenwärmer



Milchschaumer
Hot & Cold



Filterpatrone CLARIS
Smart



2-Phasen-
Reinigungstabletten



Milchsystem-Reiniger



Riguardo



Malabar Monsooned,
Indien



Impressa

Exhibit 26.12 Jura Elektroapparate product line

Company Profile 13: Fraisa Group²⁰—Global Power in Metal Cutting Tools: Mill, Drill, and Thread Any Hard Metal

A Bankruptcy Leading to a New Opportunity

In the 1930s, Johann Stüdeli, born in 1888, worked for the watch company Meyer & Stüdeli SA, which was founded in 1905 by his father and Mr. Fritz Meyer. In 1934, he decided to start his own business. From the beginning, his business idea was centered on the development and production of superior milling cutters. During the steep recession that hit the Swiss economy at that time, he took his chance, bought out the toolmaking part of a company that went bankrupt and founded Fraisa SA.²¹ With great energy, he steered through this difficult time in Swiss and world economy. After the great recession, the company developed well and rapidly. In 1948, Johann moved the company to Bellach outside of Solothurn, where he built the first dedicated building for his company. At that time, his son Hans Stüdeli, born in 1921, already worked with him. From this small beginning, Fraisa SA developed into a global supplier of sophisticated metal cutting tools employing a workforce of more than 550 and reaching sales of CHF 110 mio (2018–2019) while navigating technological and economic turmoil. Despite generational changes, Fraisa remained a family-owned and family-managed company.

Turning into a Second-Generation Family Company

The company founder, Johann Stüdeli, passed away unexpectedly in 1950, and his son Hans took over responsibility. Hans Stüdeli was to remain in control for almost 45 years until he retired at age 75, having led the firm through a series of significant technological changes.

From the beginning Fraisa was producing milling cutters made from high-speed steel and designed to cut metals.

These cutting tools were attached by users to a wide range of different machine tools and greatly impacted the quality of the output and efficiency of the operation. Especially for milling, users maintained large numbers of tools for use in different applications. Tools designed for multiple functions could therefore reduce change-over time at the manufacturing end as well as reduce tool inventory complexity. Fraisa emphasized optimal design of tools to reduce costs of the operations at the machine-user level. The resulting reduction in machining time for parts produced represented an enormous savings potential for users.

²⁰This profile was written by Jean-Pierre Jeannet (Professor Emeritus Babson College [USA] and IMD [Switzerland]) on the basis of a company interview as well as publicly available information. Copyright©2019.

²¹Fraisa was a derivative of *fraiser*, French for milling.

Developing a National and International Sales Network

Sales and distribution were, at first, centered on Switzerland. Exports were handled by dealers and distributors who carried a large number of different tool brands and a full range of tools. Fraisa did not engage in direct sales outside of Switzerland but built up an international network of distributors all through the 1980s.

A first change in the distribution model was prompted by the bankruptcy of its dealer in Lyon, France. Fraisa, to avoid a loss of CHF 300,000, took over the Lyon dealer in 1984. This became the first foreign subsidiary, and direct customer support could now be provided in France.

Another step was taken in 1988 when Fraisa Deutschland GmbH was founded by taking over a small distribution company near Düsseldorf that also had a workshop for special tools and the resharpening of cutting tools. This move was to lay the foundation for what would years later become a combination of standard tool sales and service with over 100 employees today. An Italian subsidiary was founded in 1992. As trade barriers started to be reduced, the expansion into European markets became a necessity, because European competitors of Fraisa started to enter Switzerland.

Technology Shock Through Coating Technology for Tools

In 1980, Balzers AG, a Liechtenstein-based company, demonstrated at a German exhibition a new technology for surface hardening of metal tools, thus extending their useful life. Already, the first generation of this thin film coating technology, also called PVD coating, extended the tool life by a factor of 5, and coated tools could operate 1.5 times faster than standard steel tools. The second generation extended tool life by a factor of 10 and allowed to operate 2.5 times faster, compared to uncoated tools.

Hans Stüdeli was quick to see both the potential and threat of this new technology and that it could radically change the tool industry. Fraisa not only became the first end mill manufacturer to adopt coating, while other firms in the same industry were hesitant to take that step. Stüdeli also priced the coated tools at a premium of only 1.5 times the price of regular tools for the first generation of coated tools, and 2.5 for the second generation, something that other toolmakers could not understand. They pushed Stüdeli in vain to increase his prices.

A customer who buys this tool will not soon buy another tool. If we do not adopt this new technology, another company surely will. Customers will save on machines by buying fewer machines. They will not save on tools because their speed was up. Self-cannibalization is better than being cannibalized (Josef Maushart on Hans Stüdeli).

In the years following the adoption of the tool coating technology, Fraisa's business expanded rapidly. As sales reached CHF 50 mio by 1990, Fraisa had acquired 10 major CNC machining centers for CHF 1 mio each. The German acquisition had required another CHF 2 mio. And in 1988, Fraisa acquired Schäublin

AG (ESO), a leading manufacturer of threading tools and gauges, for CHF 12 mio, allowing Fraisa to offer the full range of metal cutting tools. However, ESO was unprofitable at that time and technologically lagging. These investments were geared toward broadening the sales organization and the program range of Fraisa. Despite a good gross cash flow, the net cash flow was negative and had to be compensated for by bank loans.

New Materials Causing the Next Disruption

As Fraisa was enjoying success with coated tools made from high-speed steel, new storm clouds developed. Slowly, materials harder than steel began to emerge and changed the requirements for tools. The new generation of tools was no longer made from steel, but from so-called hard metals. During this shift to hard metals, the combination of heavy investment during the previous decades and a slowing down of the economy led to losses at Fraisa.

It was at that time that Josef Maushart, a young 25-year-old engineer from Germany with a degree from the University of Applied Sciences Landshut, joined Fraisa/ESO in 1990 as an R&D engineer and soon became the head of the research and development department. Maushart joined the group tasked with developing hard metal tools. *We were behind, almost too late*, Maushart says about that time. The team decided to respond by coming up with a next-generation tool, leapfrogging developments, and avoiding mistakes made by the pioneers. It took 3 years to develop the production technology for hard metal tools and the tools themselves! At the EMO Fair in Hannover in 1993, Fraisa could present the first full program of hard metal milling cutters. Only 2 years later, the young team could present a world innovation at the Milano Fair in 1995, namely tools for high-speed cutting of aluminum and steel. With this, Fraisa immediately joined the group of leading companies in the field of hard metal milling cutters despite having entered the market late.

Confronting Ownership Changes and Management Turmoil

As early as 1982, as Hans Stüdeli was approaching retirement at the age of 62, he was beginning to plan for the third generation of Stüdelis to take over. As the father of three daughters, none of them with a technical background or interest in the business, he reached out to his sons-in-law for future leadership of the firm. Two joined management of Fraisa and, together with the Operations and Production Manager, were to continue to lead the company. Hans Stüdeli was still in charge as Chairman of the Board and CEO, but gave the team great freedom to develop the company.

Taking over this responsibility was a big challenge for both sons-in-law, their backgrounds being law and economics and law, respectively. Together with the very experienced Operations and Production Manager, who had worked for Fraisa since

the early 60s, they found their way into the business. One took responsibility for operations and production, as their colleague approached retirement age, and the other took over administration and sales. That worked well throughout the 80s. At the beginning of the 90s, however, things changed. More and more companies offered coated tools, profits started to decline and the company entered a period of losses, causing friction within the Stüdeli family. As the company was struggling to catch up with the developments of hard metal tools, Hans Stüdeli, then aged 75, pulled the emergency break. Although reaching sales of CHF 44 mio in 1994, the company had run up CHF 40 mio in bank debt and there were serious concerns whether the company would survive. He orchestrated a change in management which resulted in one of his two sons-in-law leaving the company in 1995.

Stüdeli, confronted with the risks faced by his company, realized that Fraisa needed professional leadership from outside the family. He approached Josef Maushart, who had successfully led the development team for hard metal tools. Just 30 years old, Stüdeli first offered him the role of head of R&D and a position in the management leadership team, but soon followed up with an enhanced proposal that Maushart assume the management of the entire company as its CEO. Maushart could pull two other young managers into the leadership team. Together with the remaining son-in-law and one of the daughters of Hans Stüdeli, as well as with the former production manager, who prolonged his working time over retirement, a fresh start was made at the beginning of the Fraisa business year 1995/1996 on March 1, 1995.

The financial situation required immediate attention. As a first major step, the young team undertook the long-overdue complete integration of the ESO operation in Oberdorf (BL) into Fraisa in 1997. ESO had been run as a freestanding company since its acquisition in 1988.

In the same year, the generational change in Fraisa ownership was completed when Hans Stüdeli turned over the majority of company shares to his daughters Susanne Schibli-Stüdeli and Charlotte Froelicher-Stüdeli, both being linked to the business, in case of Charlotte Froelicher directly, as a member of the board, and in case of Susanne Schibli through her husband, Markus Schibli.

Globalization Impacts on the Fraisa Distribution Model

At the beginning of the new century, the market for cutting tools had changed fundamentally compared to the 1990s. On one hand, big distributors started to come up with lower-priced private label tools for the European and US market, mainly copies of other tools but produced at significantly lower costs in Asia! On the other hand, real global companies were arising, partially by organic growth but to a large extent by acquisition, the biggest of them being the Swedish Sandvik group. Others included the SECO group and the German Walter Group. It was from there on no longer a business of millions but of billions.

Fraisa found itself suddenly confronted with low-priced Asian products imported into its own, accustomed markets, and no entry barriers to contain the trend. With its

reseller model in danger, the company was looking for ways to defend its business that could not be easily copied or sourced from Asia.

Adoption of the New Business Model “ToolCare”

The young Fraisa management team concluded that only added services would protect its business from Asian knock-off competition. Fraisa rolled out its ToolCare model involving tool inventory management to make machining workshops more efficient.

The next step led Fraisa into the tool refurbishing business and was a major break from the reseller model. If professionally done, refurbished tools could be used two or three times before their end of tool life. However, refurbishing could neither be done by the customers nor on customer premises, requiring an external service operation. Fraisa established special collection boxes for used tools on customer premises, provided pickup with its own trucks, and in 2000 acquired a specialized company in Langnau i.E. for the servicing of collected tools. This service was also extended into Germany, a major market for Fraisa.

In Switzerland, every location was eventually serviced by Fraisa through its own pickup service. This refurbishing business did lead to a cannibalization of Fraisa’s main business with about half of its volume going through the new service unit.

Globalization of Tool Producers Becomes Yet Another Threat

Starting around the year 2000, there was a massive trend toward globalization of tool producers. Large, integrated companies emerged which produced inserts for tools made of very hard material. Among those were Sandvik from Sweden and Iscar from Israel. Both firms also acquired other companies and had their own distributors and dealers. They offered a full assortment for every production process, beyond milling or grinding.

To combat this new threat, Fraisa embarked on a strategy to lower its costs. The sales company in Hungary was expanded and a service and toolmaking business acquired there. On this basis, the first production for standard tools outside of Switzerland was established. This was a difficult step for management and owners, because it was the first time of producing tools abroad and naturally there were fears whether this could be the beginning of the end of Fraisa tool production in Switzerland.

Global Developments Triggered a Management Buyout

Upheaval in the tool market continued, and the consolidation of toolmakers led to a number of inquiries from abroad to probe if the Stüdeli family would be interested in selling the business. In 2003, one Swedish firm in particular had expressed strong

interest in Fraisa. Hans Stüdeli, now at the age of 84, had already handed over ownership equally to his two daughters Fröhlicher-Stüdeli and Schibli-Stüdeli. Although loyal to the family business, neither of them was deeply involved in technology, and Maushart wondered what would happen once Hans Stüdeli died.

Maushart became concerned, because he and the management team that restarted the business in 1995 might lose their jobs if another company acquired Fraisa. He decided to approach the two sisters directly. As it turned out, their views of ownership and succession were remarkably similar to his. For them and their father, the owner-manager model was more compelling than the family-owner model, and they agreed to a management buyout on the part of Maushart.

As this process began, none of the financing had been decided upon. For Maushart, the prospective new owner, it was clear that 100% ownership was the goal. A price of CHF 44 mio based on the book value of the firm was agreed on. The large Swiss banks that were approached declined to arrange for financing. The deal was saved by the Stüdeli family, providing the financing themselves and letting Maushart pay back the financing through the future cash flow of the business. In return, the original owners remained actively involved in the company during the repayment period which lasts until 2021. The transfer of ownership took place in 2005 with the intent of continuing Fraisa as a family owner-managed business over the long term.

The management buyout was followed by periods of strong growth and expansion, reaching 10 to 15% annually. With ownership clarified and a long-term perspective in place, the firm was reorganized, new investments were made, the direct sales force expanded, and sales reached CHF 117 mio. The workforce grew from 450 to 600 employees in 3 years, hiring 50 persons annually just to keep up. Despite a change in the CHF/Euro exchange rate from 1.67 to 1.40, profitability was strong—which helped funding the buyout. The period of 2005 to 2008 gave the impression that the MBO was a good deal for the new owner.

Navigating the Financial Crisis of 2008/2009

When the global financial crisis took hold, Fraisa management thought at first this would not touch the real economy. By the time Maushart and his team attended the AMB Fair in Stuttgart in the fall of 2008, growth in business had stopped. By January 2009, monthly sales had declined 6 months in succession to reach an annual level of CHF 60 mio, half of the previous sales record. This brought about the first losses experienced by Maushart and his management team since taking over in 1995. In early 2009, the company burned through CHF 12 mio in cash before action was taken.

Over the next months, Fraisa moved to shortened weekly work hours, reduced costs, but most importantly reduced head count by 160 positions. These reductions came from closing the Oberdorf (BL) plant by moving production to Bellach and closing the Langnau service business by moving the refurbishing of tools to Germany.

In order to get through this difficult period, Maushart practiced an open communication policy on the status of the company and future plans. The massive job losses took a toll on Maushart who admitted to sleepless nights. A loan scheme to help those who lost their job was instituted and about one-third of those who qualified for it took it up. The experience showed that unskilled staff had the hardest time finding new jobs, as the first ones to get hired were skilled workers.

By the second quarter of 2010, growth started to pick up again. Despite the Euro standing at 1.15 or less, profitability rebounded, and employment in Bellach remained at 200.

Refocusing the Business Model

Coming out of the turnaround following the crisis in 2009, Fraisa instituted a new focus strategy that covered market segments, production, and service.

Fraisa intensified its focus on tools for hard metal milling and correspondingly becoming excellent at the sharpening process. Revenue was targeted to be composed of 80% standard product sales, 10% service revenues, and 10% sales of customer-specific tools. The prices for reserviced tools should amount to half the price of new tools.

Concerning its market space, Fraisa centered on milling cutters made from highest performance carbide materials, selected the core function of milling, and put into that product/market combination a complete assortment of about 5000 articles which put it on top in that very specific niche market segment.

Constantly Evolving Its Manufacturing Footprint

Fraisa's manufacturing footprint had undergone both expansion and contraction over time, while becoming increasingly globalized. Manufacturing operations at its Bellach plant in Switzerland was now the only production point in Switzerland with two others closed during the crisis years. The operation in Hungary, first started in 2002 and expanded in several steps, comprised more than 150 employees today and produced around 55% of Fraisa standard tools. Since the Swiss Franc gained more and more strength over the years, Fraisa's good economic situation had largely to do with the internationalization of production.

The production processes at Fraisa were becoming increasingly automated with equipment running 24/7 and unattended throughout weekends and the nights. To achieve this degree of automation, production lines were equipped with a combination of purchased machinery as well as parts specially developed with partners and suppliers, leading to a production line unique to Fraisa.

Building an Extensive Service Footprint

With the emergence of global competitors and Asian imports, Fraisa had begun to develop its service side of the business, targeted at about 10% of total revenue. With ToolCare[®] 2.1 Fraisa developed a comprehensive tool management system made available to customers for improving efficiency at the tool user level. With the refurbishing and resharpening service ReTool[®], Fraisa brought preused tools back to the effectiveness of new tools. The service ConcepTool comprised the creation of tools specific to customers' applications. And through ToolSchool, Fraisa offered a full range of training programs for customers.

The latest addition to the service concept was Fraisa's ReToolBlue, a service to recycle valuable hard metal materials and to return them into virgin tool blanks for new production. This service, centered in its German operation, recycled some 75 tons of valuable material, thus lowering the customers total cost of ownership for Fraisa tools.

Sales Footprint

Sales of Fraisa tools took place worldwide through two main channels. Sales and logistic services were carried out through company-owned sales units in Switzerland (also for Asia and South America), Germany, Hungary, Italy, France (Benelux and Iberia), the USA (North American region), and in China (for China and Taiwan). In addition, sales and support services were rendered through a network of independent dealers across a large number of countries.

Bringing Up New Talent

In its business and operations, Fraisa needed a top-notch crew in grinding to create tools that would perform flawless milling operations for its customers. Fraisa therefore placed great importance on the development and training of its own manufacturing workforce. It maintained an active apprenticeship program for manufacturing jobs. Of equal importance was the extension and enhancement of qualification of its older workforce, many of whom did not have a completed apprenticeship, and yet they were valuable members of the company.

The experience during the financial crisis with the job search difficulties of lesser qualified members of the workforce led to the adoption of a widely recognized apprenticeship program for nonskilled workers. Since 2012, 22 workers graduated from the program with a Federal Diploma equivalent to the 3-year apprenticeship programs offered for younger staff, with half of them 50 years and older. This

program allowed the previously less qualified workers to now keep up with the requirements of Industry 4.0 and IoT developments.

New Strategy for Resourcing and Financing the Company

The lessons from the financial crisis made Fraisa change its financial policies. Zero outside debt, financial strength, and dependability became top priorities. Debt would be used for mortgages only with up to 50% of building value.

Profitability had to ensure that the company could make CHF 8 to 10 mio of investments annually, for which the company needed both product and volume growth.

A crisis makes you think about things that appear to be nontouchable. For an owner-managed firm, you need to respect some limits, which are 3–4% of annual growth and not much more (Maushart).

Detailed results for 2018/19 were published as had become customary for Fraisa. Sales reached CHF 110 mio, with an EBITDA of CHF 27 mio. This allowed the company to spend CHF 6.6 mio on R&D and invest CHF 9.5 mio in fixed assets and machinery, and its global workforce grew to 547. External financing amounted to just 7% of total assets, and the capital ratio reached 62% of total assets.

Governance Experience at Fraisa

Fraisa operated eight legal companies or organizational units. The Fraisa Holding as the owner of the other seven companies around the world was managed by the same management team and board as the Swiss Fraisa SA, with Josef Maushart acting both as CEO and board chairman for the two firms. The former owners, the Schibli and the Fröhlicher families, remained active on the board. Joining Josef Maushart on the board were his wife, Ursula Maushart, and Florian Maushart, their oldest of three children, an EPFL Lausanne graduate but not involved in the operating business of Fraisa.

Reflecting on the ownership experience, Maushart believed that the financial crisis made it look like the price paid was on the high side. From a 2018 perspective, a more balanced long-term strategy was now possible.



Exhibit 26.13 Fraisa product line

Company Profile 14: Filtrox²²—Global Leader in Depth Filtration. From Components to Systems and Back to Components

Founded originally in 1938 to serve the Swiss market, Filtrox soon became a globally successful company. Filtrox produced depth filters and filtration systems for the food, beverage, and pharmaceutical industries. In 2018, the company had production sites in Switzerland, England, the Czech Republic, and Mexico, as well as sales offices in France, Germany, Spain, the USA, Singapore, and China. Filtrox employed 350 worldwide, of which 90 in Switzerland, and achieved consolidated gross sales of CHF 65 mio.²³

Founded in Troubled Times

Little was known about Hans Schmid, founder of Filtrox, who passed away in 1948. He was known to have worked as sales representative in Switzerland for Seitz, a German company, inventor of depth filtration. Up to the 1930s, the Swiss beverage industry relied completely on imports for its depth filters. Presumably, due to political developments in Germany and the threat of the borders being closed, Hans Schmid thought about founding a company for the production of filter media in Switzerland. He signed a licensing agreement with Emil Begerow, another filter specialist from Germany, who had set up his own factory some years earlier, to supply the required expertise, and Schmid went from salesman to becoming a producer.

The decline of the embroidery market had left thousands of people unemployed in Eastern Switzerland, as well as many vacant factory buildings. In 1938, living near Zurich, Schmid acquired a former textile plant in St Gallen to start Fabrik Filtermaterialien Hans Schmid, to change the name to FILTROX Werk Hans Schmid AG 2 years later. What exactly FILTROX stood for was not known, other than that OX might stand for “oxygen” or “inox,” such as stainless steel used for filter equipment.

Beginning Modestly

During the initial years, the company employed a small staff of seven. Filter sheets were largely produced manually. As Swiss breweries and wine producers had sourced their filter media from Germany, the new company had to put forward considerable effort to persuade users to buy filters from Filtrox. Early on, the

²²This profile was written by Heiko Bergmann (Adjunct Professor of Entrepreneurship University of St. Gallen) on the basis of a company interview as well as publicly available information. Copyright©2019.

²³Kaiser, M. (2013): Filtrox 1938–2013. Published by: Filtrox AG, St. Gallen.

company also approached customers in other European countries and Israel. In 1940, the company needed additional capital to modernize its production, becoming a limited company with new shareholders. During WWII, procurement of raw materials needed for filter production became difficult as all critical raw materials, such as cotton, kieselgur, and asbestos, with the single exception of cellulose, had to be imported. Despite these difficulties, the Filtrox managed to gain a foothold in the market, growing steadily, and by 1945 employed a staff of 68.

Mastering Depth Filter Production

Depth filters consisted either of one or multiple layers of porous filtration medium, retaining particles throughout the medium, in contrast to on the surface only, as is the case of membrane filters.

The basic method for the production of filter sheets had not changed over the previous 80 years and was similar to producing paper or cardboard. Made of cellulose fibers and filter aids, and employing a wet-laid manufacturing process, cellulose was dissolved in water and milled. Various filter aids, such as kieselgur, cotton, perlite, and other minerals, were added to this pulp, which was spread out on a belt. Water was extracted (today by use of a vacuum belt), and the material was dried in an oven and cut into different formats, and packaged. Filtrox employed a batch production mode.

In 1945, Filtrox began to mechanize the production process, using a second-hand machine from a paper manufacturer converted to produce filter sheets, since the company found it difficult to find the right equipment suppliers. Lacking dedicated machines for the production of depth filters, oven and paper machine manufacturers were approached to develop specific solutions. Frequently, manufacturers had to sign confidentiality agreements, preventing them from selling the developed solution to competitors. Not all manufacturers were willing to develop new solutions together with Filtrox, preferring instead to sell standard machines. As a result, Filtrox typically became involved with niche players. In an evolutionary process, the wet production plant was continuously improved.

With the demand for filter sheets steadily growing through the 1960s, Filtrox substantially increased production capacity, first by installing an enlarged sheet machine and, in 1972, expanding the sheet production line through a plant expansion. The new production line, measuring 72 m in length, produced at a speed of 6 m per minute. Subsequently, the production line was fully automated such that the entire line, now the backbone of the company, could be run by two operators only by 2018. Depth filter production involved a considerable implicit knowledge. There were no courses offered on how to produce depth filters, leaving much to trial and error, with production know-how evolving gradually.

Entering the Market for Filter Equipment

With Filtrix initially only producing filter sheets, the demand for filter equipment led in 1946 to the foundation of Filtrix Maschinenbau AG. In this second business area, Filtrix produced equipment that relied on the filter media from Filtrix's initial business area. This dual strategy of filter media and filter equipment characterized Filtrix for decades. Over time, the filter equipment business became more important, and at times, it accounted for almost 50% of company revenue. In 1960, Filtrix inaugurated a new manufacturing building dedicated to the production of equipment.

At first, Filtrix produced filter equipment that could be fitted with its own depth filters only. Over time, Filtrix began to develop installations that did not require filter media that had to be replaced regularly, using fixed ceramic or metal filters. The first such equipment operating without filter sheets was the Filtrimat, a horizontal leaf filter for precoat filtration, introduced in 1957. In 1969, Filtrix introduced the "FILTROstar" candle filter, the first candle filter worldwide for beverage filtration. While candle filters had been used in other industries previously, Filtrix was the first company to apply this technology to the beverage industry. With such solutions cannibalizing the filter medium business, tensions arose between the two business areas.

Capitalizing on Growth in Postwar Years

When Filtrix founder Hans Schmid passed away in 1948, he was succeeded by his deputy, Josef Schaedler as managing director. The postwar years were characterized by economic growth ending with the first oil crisis in 1973. Filtrix, being innovative, introduced the kieselgur precoat filtration process, a novelty on the world market. In the 1950s, Filtrix began to set up an international network of sales agencies and presented its products at international trade fairs. Production buildings were expanded, and necessary capital was raised through capital increases, expanding the ownership base for Filtrix. In 1976, Filtrix introduced the very successful "FibraFix[®] AF" line, a new generation of filter sheets.

Globalizing Filtrix

In 1984, Toni Rusch became managing director of the company. Holding a doctoral degree as a business economist, he had previously worked in the chemical industry and had a strong international orientation. Realizing that Filtrix had good products, but was relatively small, Rusch described Filtrix as a "Sleeping Beauty." With export important, Filtrix had its single production site in Switzerland without foreign affiliations of any kind. Rusch fostered international expansion. In the following years, whenever an opportunity presented itself, Filtrix acquired smaller competitors, eventually becoming number two globally. In 1988, Filtrix acquired the UK company Carlson Filtration with about 60 employees. Carlson held a strong

position in the UK and the Commonwealth countries, where Filtrox had previously not been very active. In 1990, Rusch took over shares from one of the Filtrox owner families, becoming a shareholder himself. The company grew to 250 employees, 170 of them based in St Gallen. With a market share of over 50%, Filtrox became world leader in beer filtration. In 1998, Filtrox started a joint venture with a Czech company to produce filter sheets in Broumov, CZ. In 2001, it acquired another competitor, Papelera del Besos Placas Filtrantes s.l. in Barcelona, which had a good market position in Southern Europe. Finally, in 2013, it acquired a majority stake in Columbia Filter in Mexico to gain a better position in the North and South American markets.

Achieving Economies of Scale

For many years, Seitz, Schenk, and Begerow, three German firms and major competitors of Filtrox, encountered succession problems, getting into difficulties in the early 2000s, which facilitated Filtrox increasing its market share. Seitz and Schenk were finally taken over by Pall Corporation (today part of Danaher) and Begerow by Eaton Corporation, both US companies. Depth filtration had always been a small market. In 2018, worldwide sales amounted to about Euro 200 to 300 mio with Filtrox market share topping 20%. Filtrox viewed further growth as difficult to achieve, as it would have required to poach customers from the competitors, or to enter new segments beyond its current business, encountering many and new players.

The business for depth filtration media was relatively investment intensive. To reach sufficient scale, it was necessary to produce at least one million square meters per plant, on a 24/7 basis. Constructing such a plant required an investment of Euro 15 mio. On the other hand, the end-user market was fragmented, requiring the accumulation of thousands of customers, such as small winegrowers, in order to reach a sales volume of one million square meters annually, “feeding” such a factory. This in turn required a distribution network that had to be built up over many years. With market entry barriers high compared to expected returns, hardly any new players entered in this market.

Filtrox, in contrast to its competitors, had adopted a distributed manufacturing footprint. Whereas competitors had organized production around few, large, concentrated single production locations, Filtrox operated three production facilities beyond Switzerland, namely in the UK, the Czech Republic, and Mexico. With one production line each, the sites ran a base program and then offered specialty products for their specific markets that were not produced at all sites. Since logistic costs were significant for shipping finished products, distributed production added flexibility and responsiveness for local markets.

Moving into New Application Segments

Filtrix traditionally concentrated on filter solutions for the food and beverage industry, and beer breweries in particular. Too heavy a reliance on this market was increasingly perceived as problematic, prompting Filtrix to move into the life sciences sector. In 2002, Filtrix launched the PURAFIX[®] filter sheet line, specifically designed for pharmaceutical applications. In 2006, Cristian Rusch, son of Toni Rusch, became CEO, fostering diversification into new depth filtration applications. In 2012, Filtrix received the Innovation Award at ACHEMA, Frankfurt, for FILTRODISC[™] BIO SD, a new system for the filtration of cell cultures in biotech industry, and in 2014, it introduced the SYNTHAFIX[™] P line of filter sheets specifically designed for filtration of pharmaceuticals derived from human blood plasma. In 2001, Filtrix entered another new market with the acquisition of Filtercorp Inc., a US company specializing in the filtration of frying oil. In this market, depth filters with activated carbon allowed restaurants or industrial fryers to use their frying oil longer, increased the quality of their food, and it proved to be a fast-growing business. In 2018, already half of the sales volume were coming from the new market segments. Filtrix continued to innovate in its traditional markets, launching FIBRAFIX[®] TX-R in 2011, a filter to remove TCA (cork taste) from wine, for which the company earned an Innovation Award at SIMEI Milan.

Confronting a Growing Divide

Filtrix operated in two business segments, filter media, and equipment. Equipment consisted on the one hand of media-carrying equipment, which was the smaller part, accounting for about 10–20% of sales. The other part contained systems not requiring any filter media. Through a number of acquisitions and investments, Filtrix had grown substantially in the 1990s, and at the beginning of the 2000s, management realized the need to streamline its product portfolio, becoming more than a specialist and less of a generalist.

As a small company and niche player, Filtrix did not want to be active in too many markets. At that time, Filtrix produced a portfolio ranging from equipment, such as wine presses, to depth filters for different applications. Management came to realize that Filtrix was no longer able to innovate across such a broad product portfolio. Every product required constant innovation, absorbing scarce financial resources. In addition, filter systems for breweries were becoming ever larger in scale, making such large individual projects increasingly risky to handle for a small firm with limited resources.

If the product portfolio is too broad, we cannot invest in enough R&D for all products. Then we'll stay technologically in place and will be overtaken at some point. If we are to remain innovative, we have to specialize (Cristian Rusch, CEO).

Deciding to Split the Company

The financial crisis of 2008 eventually forced management's hand, leading to the divestment of the engineering business. While there had been ongoing discussions since 2000 about market developments, growing concentration in the brewing industry, and projects getting ever larger, the engineering part was still quite lucrative, with 2006 and 2007 turning out to be successful years and 2008 the company's record year for mechanical and plant engineering. Triggered by the financial crisis, and starting in 2009, sales significantly declined for the plant engineering business. Although beverage companies continued to produce, filter media still in demand, food and drinks continued to be sold, and pharmaceuticals less cyclical, there was extreme reluctance to invest in new large filter systems. From 2008 to 2009, sales dropped by one-third in the plant business, forcing Filtrox to take drastic measures to handle this drop. Following an intensive period of crisis management and personnel reductions, business did not improve until 2011.

Management and board decided to divest the engineering part of the company due to its low profitability, which was significantly lower than that of the filter media business. In addition, management wanted to further minimize risk stemming from pursuing large individual projects in the nonfilter media sector with corresponding swings in business cycles. The two businesses had diverged leaving too few synergies between them. Plant construction business simply followed a different logic than the filter media business. The latter was a classic distributor business, the former a direct business which required a different approach and sales skills. Filter media became considered a core business again, with everything unrelated to core destined to be sold. In 2012, Filtrox divested the engineering business to Bucher Group, a large technology group with sales of more than CHF 2 billion.

Evolving the Governance Model at Filtrox

Governance and management at Filtrox evolved over time, going through different models. At the outset (1938), company founder Hans Schmid had adopted the owner-manager model with Schmid first the only owner. With the legal change to a limited and incorporated company in 1940, additional shareholders joined the company, although no details have survived. From fragmentary evidence, those new shareholders were from industrial and business families in the region. After the death of Hans Schmid in 1948, the shareholding families for many years followed the model of separate ownership and management, hiring external managerial talent and appointing a managing director who was not member of the shareholding group. Apparently, the stable shareholder structure, composed of regional families, continued into the early 1990s.

A change occurred after the appointment of Toni Rusch as managing director in 1984 who played a decisive role in the internationalization of Filtrox. In the early 1990s, when one of the owning families desired to divest its stake, Rusch was able to acquire it, returning to the owner-manager model practiced at the start of the

company, through a management buy-in. His son Cristian Rusch was later also able to acquire shares. Although the company did not divulge specific shareholdings of any individual, group, or family, the stake of the Rusch family was described as “significant,” and the owners of the remaining shares as business families from the region, none of them operated as financial groups or industrial companies.

The board, as the top decision-making body at Filtrox, had five members, with both Toni Rusch, Cristian Rusch and three others representing the interests of the other owner families. Filtrox was structured around a holding company, Filtrox Holding AG, including the operating businesses and subsidiaries. Additional companies, such as for real estate holdings, were all owned by CRS holding, where all owners, individuals, and families, were represented.

Filtrox owners and its board were oriented toward long-term value creation rather than cash returns, allowing the company to retain much of its earnings to reinvest rather than paying high dividends.

Refocusing Leading to Resurgence

The decision to divest the engineering business was painful for Filtrox, especially for its St Gallen location. The company lost almost half of its sales, and employment in St Gallen was reduced from 150 to 90. However, after the split, Filtrox became more innovative and grew faster than before, achieving double-digit growth in most years after 2013. All resources of the company could now be directed to a single business area, whereas in the past it had to be allocated between two. In 2018, Filtrox employment exceeded the level prior to the divestment, but declined overall in Switzerland. There were 350 employees worldwide, of which 90 were in St Gallen.

So, it's a bit of a special story, a company that develops in this way and then almost cuts itself apart, virtually taking out a large part of the company as a whole so that the rest develops better. Everybody prefers to get bigger and bigger. But this cut was necessary to generate growth again (Cristian Rusch, CEO).



Exhibit 26.14 Filtrix product line

Company Profile 15: Pilatus Flugzeugwerke AG²⁴—From Aircraft Maintenance to Full-Fledged Aircraft Building. International Niche Player for Military Training and General Aviation Aircraft

The Emerging Aircraft Builder in the Mountains of Central Switzerland

Pilatus Ltd was founded in 1939 in Stans, tucked away behind the internationally known Bürgenstock mountain on Lake Lucerne, on the former Swiss Air Force base Buochs. Its founder, the Zurich industrialist Emil Georg Bührle, responded to a

²⁴This profile was written by Jean-Pierre Jeannet (Professor Emeritus Babson College [USA] and IMD Institute [Switzerland]) on the basis of a company interview and publicly available material. Copyright©2019.

strategic need of the Swiss Air Force for an independent overhaul facility at the beginning of WWII. In its 80-year history, the small repair operation grew to a company employing more than 2000 at its home base, delivering more than 100 planes a year, and surpassing CHF 1 billion in sales in 2013. Pilatus built an international reputation for reliable training aircraft used by many air force customers as well as for building rugged civil transport aircraft that could take off from short runways. Its most recent model, the Pilatus PC-24 Super Versatile Jet, could operate from unpaved runways, a global novelty, competing effectively with much larger international aircraft manufacturers. Since 2000, the company was owned by a group of private Swiss investors.

Starting as Maintenance Arm for the Swiss Air Force

Industrialist Emil Georg Bührle (1890–1956) was a German national who acquired the ailing Machinery Company Oerlikon in 1923. Bührle turned the company around, made it into an arms manufacturer, and acquired sole ownership in 1936, the same year he became a Swiss citizen. Pilatus was founded as a subsidiary of Oerlikon (later Oerlikon-Bührle Holding). Construction of the Pilatus workshops began in 1940 and opened with 65 employees in 1941. Its first business was repairing older aircraft and the maintenance of fighter aircraft.

Supplying the Swiss Air Force

At the end of WWII, orders were received from the Swiss Government for the development and construction of a single-engine military pilot training aircraft, the model P-2, that went into production in 1946. To save on costs, some parts, such as the landing gear, were cannibalized from retired German-built fighter planes, and a combination of materials, such as metal, wood, and canvas, was utilized in construction. About 55 P-2 were built and remained in use by the Swiss Air Force until 1981.

Additional government business was received for gliders, also for military pilot training. From 1949 to 1957, Pilatus participated in the licensed production of British de Havilland jet fighters for the Swiss Air Force with a total of 250 jet hulls delivered by 1957. Pilatus held extensive maintenance contracts for these Swiss Air Force fighter jets well into the 1970s.

A next-generation single-engine pilot training model P-3 was developed, and 72 units were delivered to the Swiss Air Force between 1953 and 1958. This first all-metal plane built by Pilatus was intended for advanced training of military pilots, such as night flights, instrument navigation, and acrobatic flying. It led to Pilatus' first export order in 1962 of six units for the Brazilian Air Force, also for pilot training. The P-3 remained in active use by the Swiss Air Force until 1983.

Turning into a Major Supplier of Military Pilot Training Aircraft

The success of the P-3 training plane led to the decision to develop a more advanced version which saw its maiden flight in 1966. When the prototype model crashed due to a forced landing, development was put on hold. It was not until 1975 that a revised prototype, named PC-7, made its maiden flight, followed by the first flight of a production model in 1978.

Designed as a two-seater training aircraft for multiple functions, including acrobatics, tactical, as well as night flying, the plane was powered by a turboprop engine from Pratt & Whitney. This model became an international success adopted by more than 20 countries for their air force training programs, becoming Pilatus' first major export success. An advanced version was introduced in 1994, the PC-7 MkII. It remained in production until today with more than 600 planes delivered over the years.

Because the Swiss government had licensed Pilatus to sell the plane as a training model only, the company experienced conflicts when some of the foreign operating air forces reequipped the planes for military operations in violation of the export license granted. This was to become a recurring issue for the company as other, more advanced models followed.

In 1982, Pilatus started a program for a yet more advanced version, the PC-9, with its maiden flight in 1984. Conceived as an advanced turbo-engine plane, it was eventually built in several versions and quickly was adopted by several countries for their air force pilot trainings, including Switzerland, Australia, Saudi Arabia, and Thailand. More than 250 PC-9 aircraft were built by Pilatus, the US company Beechcraft, under license, built a version adopted by the USA for Air Force and Navy pilot training, resulting in about 850 deliveries. Pilatus profited from the program through license fees.

After some tests on an improved version of the PC-7, Pilatus entered into formal development of a new generation of training aircraft that would replace both the aging generations of PC-7 fleets as well as the PC-9 models. Named PC-21, the new model had its maiden flight in 2002 and saw the first series model delivered in 2008. The PC-21 was a new generation of flight trainer that allowed military pilots to complete much of their training on this plane and then move directly to flying fighter jets. This resulted in substantial cost savings as the flying conditions of a military jet could be experienced on the PC-21 which eliminated the intermediate step between turboprop engine training (in a PC-7 or PC-9) of extra modules on a dedicated jet trainer. For this to work, the cockpit layout of the plane permitted the installation of advanced avionic configurations similar to advanced military aircraft. An extensive simulation module came with the PC-21 which was quickly adopted by air force training programs in Switzerland and exported to Singapore, United Arab Emirates, Saudi Arabia, Qatar, Jordan, Australia, and France, among others. More than 200 planes were built and delivered so far.

The strategy deployed by Pilatus was to build a succession of robust training planes that incorporated ever more sophisticated functions of the next generation to

allow pilots to complete their flight training on a single aircraft that would bring them directly to the actual frontline jets.

Expansion into Civil Aviation

In its first 20 years of existence, Pilatus had largely produced training aircraft for military pilots and performed overhaul tasks for the Swiss Air Force. In 1957, the company embarked on the development of a small, all-metal, rugged transporter for civil use that was to become the Pilatus Porter PC-6 which undertook its maiden flight in 1959. Its major differentiator was the STOL capabilities (Short Takeoff and Landing) for operation on unpaved and rough airstrips in remote areas. The rugged airframe was designed for low maintenance, providing easy access for up to 10 passengers or an equivalent payload. Its simple structure made repairs in the field possible and the highly energy-absorbent undercarriage with low-pressure tires allowed the plane to operate from rough terrain.

Targeted for use where previously only helicopters could be employed, the PC-6 was cheaper to operate and came with an initial price of only USD 55,000 in 1962. Over time, the model was equipped with a more powerful engine and later models sold at about USD 2 mio (2010).

The PC-6 became legendary for a number of special feats, such as use for on-glacier landings by glacier pilot Hermann Geiger and landing on the Dhaulagiri glacier in Nepal at 5750 m, a world record for a fixed-wing aircraft. The PC-6 was in production until 2020 with accumulated 600 planes delivered, including about 100 produced on license, since 1964, in the USA. In Europe, the plane remained in use particularly for sky diving.

In the mid-1980s, Pilatus began design work on a new civil aviation model named PC-12 aimed largely at the general aviation market. Conceived as the first single-engine light plane equipped with a pressurized cabin that could seat up to nine passengers and cover distances up to 3500 km, the PC-12 was to turn into a major success with over 1700 deliveries since 1994. At first, the project encountered major obstacles as the US certification was delayed and redesigning of the wings became necessary. Final certification was not granted until 1994, 3 years after the first prototype's maiden flight.

The PC-12 retained some of the takeoff and landing capabilities of the PC-6 being able to operate from unpaved airstrips. The specially designed landing gear arrangement gave the PC-12 access to a large number of airfields unsuitable for most executive planes. The Royal Flying Doctor Service in Australia operated a fleet of more than 30 PC-12 for medical evacuation flights in the Australian outback.

Certified for single-pilot operation, the PC-12 became the plane of choice for owner-flown executive aircraft. Due to its versatility, it could be used for passenger operations, as an air ambulance, for cargo transport, or special government missions. Strong customer demand came from the USA with most planes delivered in executive configurations. The price of the PC-12 had risen over time along with improvements and reached about USD 5 mio (2017). This price was competitive

due to the plane's reliability and the fact that the resale value of a PC-12 was higher than for competing models. The PC-12 was also designed for ease of maintenance, with the layout of the engine and other key parts clearly structured, easy to replace, and easily accessible for mechanics.

Developing a Super Versatile Business Jet

The commercial and operational success of the PC-12 finally cemented Pilatus' reputation as a builder of general aviation aircraft. Feedback solicited from customers for ideas for a next-generation model showed that pilots requested more speed and range while keeping the rugged landing strip performance. Pilatus then set to work in 2007 which resulted in the PC-24, a twin-engine small executive jet that retained much of the PC-12 turboprop performance. This was Pilatus' first jet engine model. The prototype made its maiden flight in 2015, and final certification was completed in 2017. First deliveries followed in 2018.

The PC-24 was financed through Pilatus internal funding at a project cost of about CHF 500 mio. Powered by two rear-mounted jet engines, the cabin could seat up to 10 passengers and the cockpit was laid out for two pilots. The Advanced Cockpit Environment reduced the pilot workload such that the PC-24 could earn a single-pilot certification. A cargo door at the rear side of the fuselage was large enough to fit standard pallet-sized cargo. The PC-24 was the first business jet that provided such a sizeable cargo door. Designed to operate from both short and/or unpaved airstrips, the PC-24 came equipped with special gear for smooth landings on uneven surfaces and wheels that prevented sinking into soft surfaces.

When Pilatus started marketing the PC-24 in May 2014, a first production run of 84 units to be delivered as of 2020 was sold out within 36 h. In May 2019, a second run of 80 units priced at USD 10.7 mio each was half sold-out within days. Production was planned for 50 units annually commencing in 2020. The company believed that over an anticipated 40-year life cycle, the company might deliver about 2000 planes. With the PC-24 model, Pilatus was confronting more entrenched and larger competitors, such as Cessna or Embraer.

Subcontracting, Overhauling, and Servicing

Starting off in the overhaul and service business for the Swiss Air Force, Pilatus continued to acquire important overhaul mandates that provided valuable business during times when new plane orders ran low. During WWII, Pilatus did overhaul work on older Swiss Air Force fighter planes, as well as assembly of some newer models. This was followed in the 1950s by the production of some 250 airframes for Vampire and Venom jet fighters produced on license in Switzerland, and the first jet fighters put into service by the Swiss Air Force. The maintenance and rework orders on this jet fleet provided a steady workload for Pilatus into the 1970s. Another batch of rework orders followed for an older training model in 1950. Swissair based the

maintenance of its fleet of older DC-3 passenger airplanes at Pilatus in Stans until 1959. The Swiss Government continued to provide contracts for Pilatus for its Hunter jet fighters and its fleet of helicopters.

Some further subcontracting orders were received for helicopters, the Airbus system, a selection of US aerospace companies, as well as from the European Space Agency for the Ariane rocket. Additional subcontracts were entered with the parent company for nonaerospace-related products. In its early history, subcontracting work allowed Pilatus to maintain production capacities during development periods when orders from its own aircraft building activities did not assure a steady workflow.

Building Competencies over Time

To move from a maintenance role to assembling, and from subcontracting for aircraft parts to becoming a full-fledged developer and builder of competitive training or civil aviation planes, including jets, was a step-by-step process for Pilatus. At each step, the company gained valuable experience which was added on to that from earlier stages. Over time, Pilatus accumulated the experience indispensable for an airplane design and production company.

The ruggedness of its earlier training models was carried over into its civil aviation models. Its maintenance experience was turned into the competitive advantage of building planes with easy maintenance. The need to provide multiple variations of the same model series led to an expertise in modularization. The experience with STOL in the PC-6, its first civil aircraft, was rolled over into the PC-12 and PC-24 executive airplanes which made landing at thousands of small civil airports far from urban centers possible.

Focusing on Two Segments

Pilatus served two principal segments, General Aviation and Government Aviation. The first included all sales to the civil sector and comprised the large programs around the PC-12 turboprop single-engine executive aircraft, with more than 1700 planes delivered since 1994, as well as the newer PC-24 twin jet that went into service in 2018. Production of the older PC-6 Porter was ceased in 2020. Initially, Pilatus had served the government sector only, but by 2018 sales to the general aviation sector accounted for about 65% of total sales. Of particular advantage in marketing toward this segment was the program of fractional ownership: Several owners would share an aircraft and have it serviced and maintained through a central organization.

Government aviation was Pilatus' second segment and historically its largest. It comprised the military training models, such as PC-7 MkII, PC-9M, and the PC-21 military pilot trainers, as well as complete support systems and simulators. The company claimed global leadership in this specific sector. Accounting for about 35%

of sales, deliveries to this sector were characterized by a different sales and decision-making structure. During Pilatus' early history, the Swiss Air Force acted as the lead client for its trainers. In later years, it was foreign governments and their air forces who took the lead and provided the vast majority of orders. Although the contracts often comprised several dozen units to be delivered over several years, the decision-making process of government orders was complex and negotiation periods could extend over 5 years. This was more of a feast or famine type segment that also involved a difficult political decision-making system in Switzerland where the issue of relevant approval for such military training aircraft was at times intensely debated.

Geographically, sales were traditionally strongest in the Americas, ranging from 35 to 50% of sales depending on segment composition. General aviation sales were particularly strong to the USA where many owner-pilot entrepreneurs used Pilatus aircraft to reach business destinations outside major cities. Europe was Pilatus' second geographic market, with an average of about 25% of sales, in a mix of general and government aviation sales. A special market was Australia where the company was traditionally strong in general aviation sales as well as for government contracts for military training craft. Sales to Asia and Africa, averaging 10–15% of total sales, largely from government contracts for training aircraft.

Achieving Competitiveness Against Global Players

As a small player, Pilatus' competitive strength improved over the years and it managed to grow into a midsize company. Since then, over the past 20 years, sales quadrupled to about CHF 1 billion. The company managed to self-fund several new generations of planes for the government pilot training market and for general aviation while preserving a healthy profitability of about 15% of sales (at EBIT level), providing the resources to spend about 10% of sales on development, particularly as it ramped up the PC-24 program.

Pilatus was competing on superior performance for its aircraft. For the general aviation market, the ruggedness and “off-road” performance on unpaved airstrips opened up a large customer segment which otherwise was using less-performing planes to reach those airfields. In addition, the PC-24 jet was able to service both inner-city airports, such as London City, and rural strips. For military pilot training planes, Pilatus developed high-performing planes with most advanced avionics so that pilots could directly move onto a F/A-18 at the end of their training, substantially reducing pilot training costs and time and justifying a higher price tag than competing models.

Given the high cost of production in Switzerland, Pilatus used ease of maintenance and lower cost per flight-hour to balance higher acquisition costs for its customers. Ease of maintenance was designed into the airframes and modularity helped with parts or component replacement. Top quality of workmanship was provided by a highly skilled workforce. An extensive company apprenticeship program with currently 133 apprentices training in many different fields was put in place to ensure this high skill level in the future. *Swiss quality* was a marketing

argument well received by the flying community. For its design teams, the company originally relied on German aerospace engineers, but in more recent years, it recruited British designers with US education and experience.

Finally, Pilatus built a reputation for superior service both at its own manufacturing base and through regional dealers and service operators. Parts service was guaranteed for 20 years once a model was discontinued. For its government airplane programs, Pilatus provided maintenance and training support on location for which it was compensated.

Pilatus manufacturing operations were concentrated in Stans and expanded continuously over the years. Production grew from 50 units annually around the turn of the century to about 125 units per year by 2019. Half of its employees were involved in manufacturing operations. As the Swiss Franc began its steady rise against the US Dollar or the Euro, the company maintained a considerable sourcing operation from local suppliers and subjected parts design to a rigorous cost-reduction engineering process. The sourcing of avionics systems and engines from North America partially eased the currency exchange pressure. Planes destined for US delivery were customized in its Colorado operation where more than 200 employees worked mainly on general aviation models.

Moving from Corporate Subsidiary to Private Ownership

Pilatus operated in its first 60 years as a subsidiary of Oerlikon-Bührle, the large technology company assembled by Emil Georg Bührle, the founder of Pilatus. This industrial group was inherited by his son Dieter Bührle (1921–2012) and his daughter Hortense Anda-Bührle (1926–2014). When the Bührle conglomerate ran into difficulties in the early 1990s, Hortense Anda-Bührle assumed more responsibilities, including a role in Pilatus.

In 1991, Ernst Thomke (formerly ETA, Swatch, and Asuag) was appointed as Chairman of the Board. Thomke had undertaken restructuring work at another Bührle company and had come to the attention of Bührle top management which led to a mandate to restructure and relaunch Pilatus.

Pilatus was reported to be close to bankruptcy at that time, having invested about CHF 100 mio into the development of the general aviation model PC-12, a model not yet certified by the US authorities, its principal market. With some 40 to 50 planes under assembly and almost finished, Thomke supported those who believed in continuing with this development program. He stayed on the board until 1993 and was instrumental in having Oscar J. Schwenk appointed as CEO, who was to lead Pilatus for the next 25 years to new levels of success.

At the end of 2000, Pilatus was spun out of the Bührle group (renamed Unaxis) and acquired by a group of Swiss private investors for a reported price of CHF 250 mio. The new ownership group included Jörg Burkart, a banker, the Anda-Bührle family, and the retirement fund of Roche. Unaxis retained a small percentage of the shares. The initial intent was to bring Pilatus on the stock exchange within 4 years, but that never came about.

Although the company did not provide details on ownership, it was reported that both the Anda family and the Burkart family held about 45% each of the shares. In later years, there were rumors about an IPO of Pilatus, but management and some of the key shareholders opposed the move. Currently, the board was chaired by Oscar J. Schwenk, former CEO, with Gratian Anda, grandson of the company founder, and Dominik Burkart, son of Jörg Burkart, serving on the board together with two additional members.



Exhibit 26.15 Pilatus Aircraft model PC-24

Company Profile 16: DC Swiss SA²⁵—Global Niche Player for Threaded Connections. Producing Cutting and Threading Tools for Micromachining

A Global Niche Player from the Jura Region

Visitors to DC Swiss will have to venture into the Jura region, taking the train from Biel/Bienne through picturesque countryside to the small town of Malleray. It is part of the “Valley,” as it is called by the local business community, and belongs to the newly merged communities Valbirse, named after the river Birse. DC Swiss, since

²⁵This profile was written by Jean-Pierre Jeannet (Professor Emeritus Babson College [USA] and IMD Institute [Switzerland]) on the basis of a company interview as well as public information. Copyright©2019.

its foundation 80 years ago, developed from a small workshop to a manufacturing company employing about 120. DC Swiss was best known for its threading tools used to prepare threads for screws to exacting dimensions in high technology metal pieces, ranging from general engineering to watches to automotive to medical devices to aerospace and energy applications.

The factory complex of DC Swiss dominated the central part of the Malleray village, just a few steps from the train stop. The “Valley” connected the larger town of Moutier to the East with St-Imier to the West and was home to many world-class niche companies, many with connections to the watch industry.

Fallout Between Brothers Spawns a New Business

The foundation of DC Swiss had its origin in a family disagreement between two brothers, Daniel and Arnold Charpiloz. In 1882, their father, Alfred Charpiloz, created a company in neighboring Bévillard, turning components for the watch industry. Father Charpiloz left the company to the two youngest of his 13 children, Daniel and Arnold, who jointly managed the business. However, the two brothers did not get along, and eventually, Arnold bought out Daniel with the stipulations that he had to move out of town and could not enter into or start a competing business.

In 1940, Daniel Charpiloz moved from Bévillard to Malleray, the next town in the “Valley,” and acquired a watch component company that had fallen into bankruptcy. Early on he took a keen interest in spiral drills and threading technology. As he looked for the best tools around, he ended up building them himself. That was the start of his business which he would expand step by step, and first, exports went to Germany and the Netherlands. Until Daniel’s death in 1955, the company was under single proprietorship and turned into a shareholding company in 1956 with the descendants of Daniel Charpiloz as principal shareholders.

Daniel’s brother Arnold continued with the original family business in Bévillard, now operating as HELIOS A. Charpiloz SA, manufacturing microcomponents for the watch industry as well as automotive and electronics customers. The company continued to be managed by descendants of Arnold Charpiloz.

Focusing on Threading Technology

Threading was a manufacturing process, and threading tools were needed to cut screw threads. Among the standard manufacturing processes such as milling or turning, threading posed more complex problems. To design appropriate thread cutting tools, the tool manufacturer had to take into consideration factors such as extent of chip removal, the coolant supply of the machine tool, the cutting geometry, as well as raw material consistency and surface coating of the threading tool for optimal performance. From a user’s point of view, the quality of the thread governed the quality of the connection. In terms of sequencing, threads were often machined toward the end of a production process. Any faulty threading would mean

remachining the entire part, obviously to be avoided. Tools used for internal threading fell into two major categories: cutting and forming. The cutting category itself could be divided into the classical and commonly used family of thread taps and the milling and whirling technology requiring simultaneous CNC machining.

With threading a very common production process in multiple industries, the underlying materials to be threaded also played an important role in the tool selection. Threading tools used to work in different kinds of materials required individual tool geometries. In order to extend the lifetime of the threading tools, a material dedicated tool program had been offered to the market since decades.

Expanding Internationally

Given the limited market opportunity of the Swiss market, DC Swiss started early with its export business. Currently, roughly two-thirds of sales were exported. The company established about 30 exclusive technology partnerships and distributorships, one per country. Each could cover additional countries, reaching more than 50 countries in total. About 60% of company sales went through its distributor network, the rest was sold directly to end users.

To strengthen its market coverage and logistics support, the company created a subsidiary in Cologne, Germany, to handle logistics to EU customers. In Italy, an important market for threading tools, the company also operated its own subsidiary. The distribution operation in the UK was structured as a franchise. Geographically, Europe was the main destination for DC Swiss sales outside of Switzerland, 80%, with smaller percentages to the rest of the world.

Segmentation and Segment Choices

Throughout its history, DC Swiss remained focused on threading technology and the tools needed to produce high-quality threads for demanding applications. Threading tools were a niche within the much larger space of all kinds of cutting, machining, grinding, drilling, reaming, and milling tools.

DC Swiss is the only Swiss company focused exclusively on threading. It competed with several larger companies which often carried a more limited number of threading tools compared to the DC Swiss product line. Threading technology competitors existed in Germany and Italy, a few specialists operated in Japan, but no direct competitors came from the USA. There were also some broad-based global tool manufacturers that carried basic tools only and did not specialize in threading.

Focus Within the Focus

DC Swiss recently adopted a strategy of “focusing within the focus” by dividing its business into two parts. DC Thread was the unit tasked with pursuing standard

applications for standard-sized threads of 3 mm and larger, including some MEGA-applications of up to 160 mm. Part of the unit's product portfolio were a complete range of taps, roll taps, thread mills, and thread whirls for the full range of materials from stainless steel to composites. The company offered several thousand different products in this segment.

The DC NANO TOOLS line was a new unit responsible for continuing with threading technology for sizes from 0.3 to 3 mm. These smaller diameter threads were viewed as contributing more value added and better protection from copying by competitors. The DC NANO TOOLS line could offer the full range of tools, such as thread cutting, thread forming, thread whirling, plug gauges and thread ring gauges, including soft rigid tapping and tapping chucks, all focused on the small-diameter segment. These DC Swiss applications were sought after by the watchmaking, aerospace, optical, automotive, energy, and medical sectors.

Building Global Marketing and Sales Footprint

DC Swiss positioned itself as highly specialized in threading, promising the best solutions for selective applications. In particular, the company positioned its tools for demanding threading technology operations, backed up with specialized services. The company also marketed the convenience of a dedicated online tool selection program for customers using standard tools.

Sales activities at DC Swiss were divided between those carried out by the company itself, and those delegated to sales network partners. DC Swiss sales activities included employing a number of sales and application engineers; it controlled all external sales exhibitions and the training activities. Also directly controlled by DC Swiss were relationships with technology partners for industry-specific solutions and applications and the key account process. The company's own staff sold service expertise and not just functions into specialized segments. For specialized tools, the entry point at the customer required access to technical engineers at the end-user level. In general, the profile of the sales force for direct sales differed in expertise and functions from that of a sales force for indirect distributor sales.

The marketing process was supported by an online tool shop and catalog with a tool finder program for online searching. This online channel was constantly growing. Intensive use of YouTube for specific videos explaining the many different types of tools complemented these efforts.

Managing Innovations

DC Swiss had a development team dedicated to finding new technological solutions perfectly suited to its customers' needs. Over the past 5 years, four new patents were granted to DC Swiss, and another two are pending.

In 2011, DC Swiss founded Safelock SA, later on DC NANO TOOLS SA, both staffed by its own DS Swiss specialists. The latter's goal was to commercialize a special design and technology, patented by DC Swiss, involving an automatic blocking system for interior threads for use with specially designed screws in nano-applications. Among the benefits of this system were connections that did not require chemical additives, such as glue. This was an important feature since many customers still applied glue to the fastening of screws.

Threads needed to be inspected by thread gauges to ensure conformity to specifications. DC Swiss not only offered the gauge itself, but also a precision control plug gauge enabling the end user to perform quality control on site himself. In order to maintain a safe production process for the gauges, DC NANO TOOLS SA was certified and held an ISO 17025 accreditation to be able to add a SCS certificate for the nano gauge—bringing production and testing laboratory under the customer's roof.

Attracting Talent to Malleray

DC Swiss recruited its talent from the region including the cities of Biel/Bienne and Delémont. The manufacturing skill required was “grinding,” and even a trained machine operator needed 3–6 months to acquire it. Hiring functioned by word of mouth, with relatively low staff turnover. Competition in the job market of this highly industrialized region was relatively intense, particularly because of the proximity of Biel/Bienne and major watchmaking groups.

An important aspect of talent management was the company's participation in apprenticeship programs. DC Swiss employs about 20 apprentices for 3–4 years of apprenticeship. An important feature were the polymechanics apprenticeships offered in conjunction with several other local firms resulting in a broader training than that a single firm could have achieved. Apprentices were rotated among five other participating firms. Young people, after completing 9 years of compulsory education, were keen to join the DC apprenticeship programs.

The DC Swiss management had very clear and demanding requirements regarding the skills of its staff. At the same time, the intensive and broad training of the manufacturing staff meant that operators could exercise considerable control over their daily work.

Maintaining Manufacturing in the Jura

DC Swiss operated two manufacturing sites. The main site in Malleray produced all finished tools. In 1999, a second site was opened in the neighboring community Bévillard, producing tool blanks only. This freed additional manufacturing space for finishing tools in Malleray.

Between the two sites, the company produced more than 5000 tools daily or about 1 mio tools annually. DC Swiss tracked more than 8200 references, which all of them were considered standard tools.

The company operated a modern machine park with CNC machines for grinding tools to specifications. Acquiring new production equipment represented major investments beyond constructing buildings.

Frugally Managing Financing and Resources

As a privately held company, key financial data of DC Swiss are not publicly available. Sales were estimated at around CHF 20–25 mio. Over the years, the company was able to finance its investments into technology and equipment mainly internally while satisfying the owners' financial requirements. External debt was only occasionally accessed for building and fixed asset expansions.

Moving from Family Managed to Professionally Managed Company

When the founder Daniel Charpilloz died in 1955 aged 63, his business was inherited by his two daughters. That was when DC Swiss was turned into a limited liability company. One of the daughters brought her husband into the business; subsequently conflicts emerged, which led to the family withdrawing from the operational management of the company. In 1960, management was turned over to executives of the firm, and this arrangement has continued ever since. Ownership remained in the hands of the descendants of the two daughters.

During the 1980s and 1990s, three managers were running the company, one for technical and production, one for sales and marketing, and a third one for finance and administration. They happened to reach retirement at about the same time. There followed two decades when the company was led by a single CEO, supported by a management team. Since 2019, DC Swiss was again managed jointly by three directors at the top of the organization. One of the key success factors of the company was continuous leadership with technology expertise and affinity.

The company was structured along a two-tiered system with the Daniel Charpilloz Holding on top, owning all shares of the operating firms. The main company owned by the holding was DC Swiss SA which in turn held the shares in the German, Italian, and UK operations. The stakes in DC NANO TOOLS SA, the company specializing in metrological services (SCS certificate), were held directly by the Charpilloz Holding. The entire group of firms operated under the label DC Swiss Group. However, this was not a legally incorporated name.



Exhibit 26.16 DC Swiss product line

Company Profile 17: Oetiker Group²⁶—Global Leader in Connecting Solutions for Mission-Critical Applications. Creating Peace of Mind Through Billions of Connections Every Day

Turning Oil and Gasoline Spots Under Cars into a Global Business

When Hans Oetiker (1918–2002) stepped out of his small workshop in the hillside of the town of Horgen, he was often bothered by the oil and gasoline spots left behind by cars parked in the driveway in front of his business. His quest to see to a solution that would prevent cars from leaking oil or gasoline resulted eventually in the creation of a thriving global business with sales of about CHF 400 mio, employing some 1900 in 14 factories spread over three continents, present in 31 countries, and serving about 90 million vehicles built annually all over the world. Almost every car built today came equipped with some of the connectors engineered and produced by the Oetiker Group. Millions of people the world over, largely unaware, relied every day on billions of Oetiker connectors for critical functions of their products and equipment, often performing reliably but hidden away from their view.

Hans Oetiker Started a Small Workshop During WWII

Little in Hans Oetiker’s upbringing would have suggested the future innovator and entrepreneur. Born into a family with a small farm in Urdorf, outside Zurich, his father passed away early and his mother took over to run the farm. Oetiker entered into an apprenticeship as a toolmaker with Brown Boveri Co. (BBC), a large international manufacturer of electrical machinery and power generating equipment, since merged into ABB.

In 1942, at 24 years and in the midst of WWII raging all around Switzerland, Hans Oetiker decided to strike out on his own. He set up shop in the upper parts of Horgen, working as a contract supplier for his former employer BBC, supplying parts that required machining and forming.

In 1947, Oetiker invented his first piece of equipment, a punching machine for forming and punching metal parts. In 1949, Oetiker invented and patented pressure-based couplings. His couplings, used with pressure tools, came equipped with a “click” function that signaled to the operator that the connection was safe.

He acquired an unused factory from Schindler, a large Swiss-based elevator manufacturer, as his workshop. To others, this move did appear “crazy” since there was another machining company in the vicinity, Schweiter, suffering, and declining. And there was young Oetiker nearby, investing in his own manufacturing site!

²⁶This profile was written by Jean-Pierre Jeannet (Professor Emeritus Babson College [USA] and IMD Institute [Switzerland]) on the basis of a company interview as well as publicly available information. Copyright ©2019.

An Observation that Kick-Started the Business

Oetiker, forever the tinkerer and inventor, was not satisfied with his growing business. As pointed out earlier, Oetiker noticed the small oil and gas spills left by parked cars and was eager to find connections for oil and gasoline hoses attached to car engines that would prevent any spots. His solution, for which he was granted a patent by the Swiss patent office, was an ear-shaped clamp, referred to as an ear clamp, for which he also adapted his stamping machines to make mass production of the clamps feasible. The ear clamp was a global innovation that was to fuel his business for more than 25 years when a succession of follow-on clamp designs was introduced to the market.

The Oetiker Business Model

Oetiker supplied a full product line of clamps with successive new models of clamps driven by customer requirements, while keeping old models in the line-up. The result was a cumulative product line, and all later clamp models were improved variations of earlier ones.

The company followed a business model akin to Hilti's (fasteners for construction) combining the clamps with the appropriate fastening device for either manual or automated fastening for enhanced productivity. The product sold was thus a service combining the "disposables" with the necessary equipment, all under the single corporate umbrella of Oetiker. Oetiker communicated its business model as its 360-degree solution approach combining connecting and assembly solutions with global customer services.

Oetiker connecting solutions included clamps, rings, straps, and quick connectors for a full range of applications. Assembly solutions consisted of assembly equipment, or tools, such as mechatronic power tool systems, pneumatic pincers, manual pincers, swaging devices, and test equipment, all engineered for the assembly of its proprietary line of connectors. The assembly solutions were engineered to make assembly line installation efficient and reliable.

Oetiker also provided its customers with technical analysis and consulting, special application engineering to create proprietary solutions, corresponding testing and validation procedures, commissioning, training, and maintenance services.

The Oetiker Business Focus

Oetiker focused on connectivity through engineered solutions that either held fluids or kept them from leaking. Through its engineered solutions, Oetiker steered clear from producing DIN standard parts where margins were lower than for customer-specific engineered parts.

Producing and selling more than 2 billion units annually made Oetiker market leader. Clamps of all types accounted for 75% of business volume, 70% of which

were for passenger cars. The company saw this as a relatively low risk and considered its business focus to be sufficiently diversified by the application industry segment not to actively search for diversification beyond the current focus.

The business based on couplings dating back to the company founding was divested in 2012 when the company concentrated entirely on its connector business.

Targeting Key Segments

Ever since the creation of the clamp business line, automotive had been the major target segment of Oetiker, with 70% of its sales. Another 10% came from commercial vehicles and 20% from general industry.

The core automotive segment was comprised of passenger vehicles, two wheelers, and off-road vehicles. The commercial vehicles segment accounting for 10% of sales included trucks, buses, construction vehicles, tractors, and marine and aerospace applications.

Oetiker connecting systems were used in a number of vehicles areas, such as powertrain, drivetrain, and occupant safety applications. Powertrain applications included connections for air intake, exhaust, or cooling and heating systems. In the drive train area, Oetiker systems were used for velocity joints and steering systems. A full range of connecting systems had also been developed for electrical cars.

Industrial applications covered a spate of different industries, each with its own specific requirements. Included were home and gardening applications, home appliances, agriculture, food and beverage, and medical applications. Also included in this sector was the after-market to repair shops to replace Oetiker-installed products.

Driving Innovation

Ever since the development of the first punching machine in 1947, company founder Hans Oetiker followed up with a range of new connecting systems at regular intervals. In the past 10 years, the company brought to market several generations of different clamps which were partial improvements of earlier systems, or new models, for better inclusion in automatic clamping systems. The StepLess was introduced in 2008, followed by a number of different locking systems: ToothLock versions in 2011, PEX Preset Clamps, the WingGuard strap clamp, and the ForceOne hose clamps, all in 2014, followed by the ForceTree MCR interlock system in 2015. Most of the Oetiker clamping products remained in production for many years and some were produced for its replacement parts business.

Other than clamping and connection systems, Oetiker also developed new installation systems. An electronically controlled assembly system was introduced in 1998, and the Oetiker Fast 3000 technology was introduced in 2014.

Innovation at Oetiker was carried out in several locations and was not dependent on the Swiss head office location alone. While the rhythm of new connection

systems was managed from the center, the various locations, through their multiple direct contacts with customers, contributed ideas for new products or assembly systems.

Moving Early on Global Expansion

Oetiker began international expansion early with an operation in Austria in 1959. North America followed with operations in Canada (1961) and the USA (1963). From 1972 to 1992, Europe was the main focus, concentrating on the large automotive markets of Germany (1972), UK (1979), France (1984), Spain (1985), the Netherlands (1991), and the Czech Republic and Hungary (1992). After that followed expansion into Asia to China (1995), India (2006), Japan (2007), and Korea (2011). More recently, the company added Morocco (2003), Brazil (2012), Russia (2013), and Poland (2017). Oetiker did not engage in any joint ventures. Entry into China in 1995 was the company's largest single investment and was a big step in its globalization drive.

The global expansion was driven by customers who were largely "tier" suppliers to the automotive OEMs. Numbering in the several thousands, the globally dispersed customer lists prevented risk accumulation. Sales operations were in the hands of application, not product managers, distributed globally and who held regional responsibility. The application managers assignments included identifying opportunities and, maybe, to even anticipate them as well. The starting point was always the client's needs. Some of these application managers were based at production locations, with the majority operating from simple sales offices only. This distributed sales and customer service operation allowed the company to interface with customers in their own culture and language which Oetiker considered a competitive advantage since many products needed to be customized.

Building a Global Manufacturing Footprint

Oetiker did not see itself as a typical Swiss exporter, exporting only the production tools, not the end product itself. Its head office in Horgen was staffed by about 110 employees, out of the global head count of almost 1900. Production activity in Horgen focused on core tools needed for the 12 foreign production operations. Key tools were needed for stamping operations, assembly tools, and critical components for production machinery located in the various foreign production operations. Production equipment was proprietary and engineered or adapted by Oetiker for its own needs.

Production was organized around process lines per product, and the various production operations could comprise different numbers of such process lines. The activities included punching and bending of metal into the required parts. The size of production operations ranged from 70 employees for the smallest unit to 350 employees for the largest.

Most production plants were for clamps, a few were also producing tools needed to incorporate the clamps in assembly operations of Oetiker clients. Typically, the clamp operations were located near clusters of customers, the “tier” automotive suppliers. Main production centers were located in Europe (Germany, Spain, Sweden, Lithuania, and Poland), in North America (USA and Canada, 4 plants in total), and Asia with plants in China and India. The centers all produced the most common clamps, or lead products, some specialty clamps were produced, according to customer specifications, in selective locations only.

Production plants being spread globally and operating within the currency area of Oetiker’s customers worked as a hedge against damaging currency fluctuations tied to the Swiss Franc.

Using Acquisitions to Add Assembly Tools or New Segments

Since Oetiker clamps needed to be assembled in large quantities into different parts by automotive subassemblers, the company used acquisitions to put together a set of tools and equipment that could be used for that purpose. With this goal in mind, Oetiker acquired Allert in 1997. Founded by Kurt Allert in 1959, the company had been active since 1980 in fastenings for the automotive sector, as well as supplying hinged steel belt conveyors. Allert continued to operate under its brand name and was kept a separate legal entity as a fully owned subsidiary.

Levi Peterson, a Swedish company founded in 1914 and active globally in engineered fastening devices specializing in commercial vehicles, was acquired in 2014 and operated since as Oetiker Sweden AB, combining sales and production operations on the same site.

Also, in 2014, Oetiker acquired Rostra Tool Company, based in Connecticut, USA. Rostra, with a 150-year history, marketed its flagship brand ‘Sargent Quality Tools’ hand tools for crimping, pressing, cutting, and stripping, to wholesale distributors and other industrial users. For Oetiker, the hand tool lines added to Oetiker’s system approach serving clients not only with connecting solutions but also providing them with required installation tools. Rostra also had a strong position in the PEX plumbing connection market, another important strategic objective for Oetiker. The company was now operating as Oetiker Tools but kept the Sargent brand names for some products.

More recently, Oetiker acquired the US company Jiffy-tight in 2016. Jiffy-tight was a leading manufacturer of engineered fluid connection parts giving Oetiker a stronger foothold in the quick connect market segment.

Preserving the Family Business

The Oetiker company was a family business currently managed and run by Thomas Meier-Bickel, third generation of Oetiker family. His grandparents and founders were not comfortable leaving all the shares in the company to their children, thus

placing some shares into a foundation which supported local civic causes. Meier-Bickel's father-in-law once was chairman of the board. Half of the members of the current board were members unrelated to the family, as was the current chairman. A shareholder agreement was in place.

Thomas Meier-Bickel has been more than 10 years with the company, the last 6 years as CEO. His background was in finance and the banking industry, and his studies were in business administration. He did understand technology but admitted that he could not do engineering design drawings himself. *There is a fourth generation, but they are still very young!*

For strategic control of the company, Meier-Bickel focused on sales growth as the key metric, which was targeted at exceeding market growth. Profitability ensured financial independence and was targeted at above 10% EBIT for core business segments. Given present sales levels, this allowed for an internally generated investment budget of about CHF 20 mio annually. The company maintained reserves for acquisitions and sometimes availed itself of bridge financing. The ability to approach an acquisition object without having to resort to a credit for the deal added to the credibility as an acquirer. Oetiker operated under a long-term strategic plan until 2030. Quarterly figures were not relevant in this context.

Company Profile 18: Rüeger SA²⁷ —The Temperature and Pressure Measuring Experts. Manufacturer and Solution Provider of Sensors for Temperature and Pressure Indicators

Specialist in Measuring Industrial Processes

Founded in 1942 by Ernst Rüeger, the company remained a family business, owned and managed by the third generation. Based on an important technical development at the very outset of the company's creation, Rüeger specialized in temperature and pressure management instrumentation. Exact temperature and pressure measurement were a key variable in many industrial processes. Offering one of the world's broadest product line for a wide range of industrial applications, Rüeger developed a global reputation and a worldwide sales presence. With a staff of about 200 in Switzerland and locations in the Netherlands, Italy, Malaysia, and China, sales were estimated at about CHF 30 mio.²⁸ The company's main location was in Crissier, just outside Lausanne.

²⁷This case was written by Jean-Pierre Jeannet (Professor Emeritus Babson College [USA] and IMD Institute [Switzerland]) on the basis of a company interview and publicly available information. Copyright©2019.

²⁸As a private company, Rüeger SA does not disclose financial data. Estimates provided by the author.

It All Started in a Lausanne Garage

In the early 1940s, engineer Georges Bloch, a quintessential tinkerer and inventor, was working out of his own garage converted into his workshop. There, he invented a superior way to measure temperature changes. Bloch developed a bimetallic sensor made from two different materials with different expansion coefficients, welded together into a double spiral. The two materials could expand and contract at their free end and acted directly on a pointer when undergoing variations in temperature, resulting in more precise and accurate measurement. This process was patented.

Ernst Rüeger, who lived in Basel, was a better salesman than an engineer. At the outbreak of WWII, he moved to Lausanne, as he found Basel to be too close to the German border. In Lausanne, he met George Bloch and must have been intrigued by the concept of the bimetallic temperature measurement device. In 1942, in the midst of WWII, Rüeger created a company in Lausanne to exploit this invention. Rüeger remained in charge of the business through its first 20 years of development, retiring in 1962 to Zurich. At this point, the company became a limited liability company (SA) and management passed into the hands of his son, Rolf Rüeger.

Developing a Proprietary Manufacturing Process

Once the patent protection expired, the company did not experience any duplications or imitations. The reason had to do with the difficult manufacturing process for its probes. Rüeger, over the years, developed a unique manufacturing process based on the company's own machinery and equipment. This equipment had been custom-built by Rüeger and therefore was not available on the open market. As a result, the manufacturing process became a significant barrier to entry, which protected Rüeger beyond the patent protection time. The know-how required for the production process meant that the company produced all sensitive components in its Crissier plant in Switzerland and sent them to other locations for final assembly.

Sales Development in Phases

Initially, sales were mostly in Switzerland and to the Basel chemical industry cluster as an important customer group. Export sales grew with the first sales subsidiary opened in Stuttgart in the early 1950s, to target Germany, and sales to the Dutch chemical company DSM.

In a second phase, sales expanded into the machinery industry, for example, the Swiss company Brown Boveri & Cie, as well as the many textile machinery manufacturers.

It was the third sales development phase that turned out to be very important, namely the oil & gas and energy sector. Specialized engineering contractors, such as Bechtel of the US, would specify Rüeger equipment when building plants overseas. Over time, the end using companies, e.g. Aramco or Shell, would specify Rüeger for

their use. Today, this sector accounted for as much as one third of company sales, albeit subject to strong industry cycles.

Expanding into the Asian Markets

Rüeger's expansion into Asia was essentially a policy of following its European and US customers who were starting to make major investments in the Asia-Pacific region. The company centered its Asian expansion on Korea, Malaysia, and China.

A typical example of how Rüeger followed its clients was Sulzer Diesel where Rüeger instruments were installed in marine diesel engines. When Sulzer licensed marine diesel manufacturing to Poland and Czech Republic, Rüeger followed and supplied instruments there. When Sulzer executives indicated that new developments were occurring in Korea, Bernard Rüeger, of the third owner generation, who had joined the company, promptly took off for Korea in 1989 and was impressed to see cranes there everywhere. Coming from Switzerland with its small domestic market, he was used to going abroad to look for new opportunities. As Korea became a major shipbuilding nation, its importance for Rüeger grew accordingly.

In 1997, Rüeger opened an office in Malaysia to better coordinate and service its many agents and clients operating in Southeast Asia. By 1999, share of exports to China increased to 30%, prompting Rüeger to start production in China in 2003. The entry was facilitated through a partnership with a local producer of measuring instruments and triggered by the huge China investments of such companies as Nestle, Novartis, ABB, and Siemens, all users of Rüeger instruments in their manufacturing processes. By 2004, company sales into the Asian market had grown to 35% of sales.

In 2006, Rüeger created its own subsidiary in China with a total of 30 employees. Production of core elements of the measuring instruments was still manufactured in Switzerland only and shipped to China for assembling and customization for the many industrial applications.

Reflecting changes in the Chinese market, Rüeger began in 2017 to move its production to Malaysia. Management realized that the cost of its operation in China had grown by a factor of four over 10 years and that it was impossible to create any kind of company loyalty among its local employees. As a result, staffing declined from a top of 40 to just a small sales team of five, whereas the Malaysian staffing level increased from 20 to 35 due to this move.

Offering a Full Range of Measuring Instruments

The Rüeger product line expanded considerably beyond its original temperature gauges. To the bimetallic temperature gauges came also gas thermometers, HVAC temperature gauges, thermometers for marine diesel applications, and thermowells. More complex products added were temperature probes with transmitters or

multipoint sensors for use in many types of reactors. Temperature gauges represented more than 80% of company sales.

Related to temperature instruments was a line of pressure gauges. And finally, the company also produced instruments on an OEM basis used mostly in the food industry. All of those products leveraged Rüeger's core technology. In its application space, Rüeger offered one of the most extensive and differentiated product lines. Some products were manufactured in large volumes on automated or robotized lines, which allowed them to be produced in Switzerland.

Focusing Manufacturing Footprint

Manufacturing of its instruments had always been central to the development of Rüeger. When running out of space at the initial site in Lausanne, a new site was developed in Crissier near Lausanne in 1967. The company was still operating from that site.

At its plant, Rüeger manufactured its core components on the basis of its own temperature measure technology. Production processes and equipment were designed and built by the company and could not be acquired on the open market. As the company expanded in Asia, final assembly of its instruments was moved into Malaysia, where standard products were also produced. For the pressure gauge segment, products were sourced externally as that market had commoditized and could not be served any longer from a high-cost Swiss base.

Rüeger's supplying a German cookware manufacturer gave a typical example of a high-volume OEM production. Rüeger inserted its temperature measurement devices into the top of the cooking pans, utilizing a dedicated, fully robotized production line in its Crissier plant. A volume of about 500,000 units annually justified the dedicated production line.

These policies were reflected in the head count of the Swiss operation. Whereas employment at its Crissier operation was 120 people 20 years ago, it had now shrunk to about 70, with about 45 employed in production.

Building a Global Sales Footprint

Rüeger acted as much as possible as a solution provider rather than just selling products. Its own sales engineers were experienced in specifying instruments into different processes. The company maintained such teams in Switzerland, Netherlands, Germany, China, and in Malaysia.

About 60 independent agents located in many different countries supported this sales effort. Typically, the agent handled the selling, Rüeger quoted to the agent who sold and delivered the instruments to the customer. In the company's experience, the quality of its agent network was mixed, with only about a third earning the label excellent.

Geographically, more than 80% of Rüeiger sales were destined for the export market. Europe accounted for about 40 to 50% of sales and Asia for about 35%. Rüeiger was not active on the US market due to different technical specifications.

Rüeiger was competing on the precision and quality of its measuring instruments to make up for a price disadvantage compared to other competitors. The new regulation on *Swissness* posed a problem although most of the value added was from Europe. The company then traded under the slogan *Swiss Precision* and published the fact that its know-how and production center was in Switzerland.

Making Technology-Related Acquisitions

With its own research staff of 8 for the entire group, Rüeiger was also dependent on bringing in new ideas from other companies or making acquisitions. In 1981, Rüeiger acquired Stiko in the Netherlands, a company focusing on mechanical temperature pressure gauges as well as calibration. Active largely as an OEM supplier, Stiko had extensive experience with gas thermometers. Employing about 50, the company operated independently of Rüeiger, and Rüeiger did not leverage the ownership of Stiko in its marketing activities.

In 1991, Rüeiger acquired a small Italian company located in Northern Italy. Rüeiger was interested in its electrical instruments for process control rooms. Eventually, the operation was brought to Crissier, as the Italian business environment was considered too taxing.

Customers and their special requests could also be an important source of new ideas or solutions for the company. Rüeiger experienced that it was often more efficient to work on a customer request than to develop on its own without a clear sense whether the result would lead to a product. If a client was interested in a new product requiring development, Rüeiger expected the client to share in the development costs.

Rüeiger maintained active contacts with regional technical universities, such as with EPFL Lausanne in the areas of new measuring technologies, or HES St-Imier and HES Yverdon, that graduated technical talent of importance to Rüeiger.

Innovating into New Fields and Markets

In 2008 Bernard Rüeiger, then CEO of Rüeiger, managed to acquire Alpsense, a start-up firm connected with EPFL Lausanne and its regional bank BCV, and integrated it later into the Rüeiger company. Alpsense was started in 2003 by an independent inventor who used his experience in the deep oil-frying field in the fast-food industry as the basis for his PhD. He developed a system to measure the quality of frying oil through temperature. The start-up had difficulty to reach industrial scale. These products were intended for deep fry makers. The market leader in this equipment, Frymaster, already had its own solution, but the main competitor was looking for a system to integrate into its deep-frying equipment. Alpsense granted a license for the

US market, but sensors made for Europe were produced in Crissier. This was considered a substantial opportunity once the rollout was to take place with all sensitive components made in Crissier by Rüeger.

Managing Turbulence as a Family-Owned Enterprise

As a small company, Rüeger relied partially on bank financing. It maintained relations with the two large Swiss nationwide banks, UBS and Credit Suisse, as well as with the regional bank BCV.

Some economic developments, however, were difficult to navigate. When the Chinese government launched its anticorruption drive, sales in that country were impacted negatively. The financial crisis of 2008 resulted in a sales decline. Equally, the rapid up-valuation of the Swiss Franc vs. the Euro in 2015 meant that prices in Euro were increasing and had to be lowered by 20% in Swiss Francs to remain competitive. In the end, partial unemployment and reduced hours for its workforce in Crissier could not be avoided. The subsidiary located in the Netherlands did not suffer this impact because that company operated in the Eurozone.

Ownership and Governance

Rüeger remained a family-owned company with the family still accounting for 100% of ownership. After the retirement of Rolf Rüeger, son of the founder, the third generation took over in 1991 with Bernard Rüeger, grandson of the founder, nominated as the managing director, later CEO and eventually Chairman of the Board. Bernard initially trained as an engineer at EPFL Lausanne but changed into business studies as he *found engineering boring and I am a businessman*.

His younger brother, Jean-Marc Rüeger, joined shortly thereafter following a stint in the IT sector and initially assumed an administrative role, then became head of manufacturing. In 2012, on the 70th anniversary of the company, Bernard Rüeger turned over the CEO role to his brother Jean-Marc and assumed the role of Chairman while still being responsible for business development.

The owners, recognizing that the fourth-generation Rüegers had not joined the business, were searching for a solution that would allow for a continuation of the company. In April 2019, the US company Ashcroft acquired the Rüeger Group of companies, including the Dutch company Stiko, and Rüeger's operations in Germany, China, and Malaysia. Ashcroft, itself a part of the larger Japanese company Nagano Keiki, was also a manufacturer of instruments for temperature and pressure measurement. Rüeger had long-standing business relationships with the new owners who were expected to continue with the operations in Crissier and maintain the Rüeger brand, thus supporting the Rüeger operations with additional resources from the larger parent firm.

Company Profile 19: FELCO SA²⁹—Producing the Iconic Pruning Shears.³⁰ “Agricultural Cutting Tools that Can Sustain 10,000 Cuts a Day”

Started by a Mechanic in the Jura Region

When Félix Flisch (1914–2000) acquired a small workshop in 1945 which made parts for the watch industry, he had some clear ideas what he wanted to do with the modest premises in the small Jura town of Les Geneveys-sur-Coffrane in the Canton Neuchâtel. He had developed a new design for pruning shears for cutting branches and pruning trees. This first small workshop was to expand over the years to a workforce of more than 150 employees and sales close to CHF 45 mio, dominating the manual pruning shear market worldwide with what were generally accepted to be the highest quality products available on the market. In recognition of its achievements, Felco was awarded the Swiss Grand Award for Design by the Swiss Government in 2018.

Leaving Home to Look for Opportunities in the Romandie

Félix Flisch left his home Canton Appenzell at the age of 15 to work on a farm in the French-speaking part of Switzerland. After his 1-year stay at the farm, Flisch went to work for Dubied, then a regional machinery company specializing in knitting machines, where he completed his apprenticeship as a mechanic in 1934. During WWII, Flisch joined the Swiss border guards in the Nyon region where he also met his future wife, Juliette Girod (1910–1980).

As WWII ended, and with limited financial resources, Flisch acquired an old watch component company and opened his own business as Félix Flisch FELCO, as general partnership. This company he was to eventually build into a flourishing enterprise dominating its chosen market segment of hand-held pruning shears. The company name was later shortened to Felco and became a limited company in 1978 (named FELCO SA).

²⁹This profile was written by Jean-Pierre Jeannet (Professor Emeritus Babson College [USA] and IMD Institute [Switzerland]), on the basis of a company interview and publicly available information. Copyright©2019.

³⁰The Swiss Confederation granted Felco a Swiss Grand Award for Design in recognition of their visionary approach to the creation of durable products, their commitment to quality and sustainable vision in a world of programmed obsolescence.

Pruning Loppers Led to Pruning Shears and Cable Cutters

The first product Flisch concentrated on was pruning loppers. These were one-handed shears for cutting smaller tree branches and twigs, usually equipped with long handles. Shears remained in the product line of Felco to this day.

Flisch, in order to generate orders for these shears, traveled widely in the region and into neighboring countries. Business was not easy, but Flisch's ingenuity and openness to new ideas brought him two breakthrough ideas that were to shape the firm. Both were to come to the young entrepreneur in rapid succession in 1948 and 1951.

Responding to a Winegrower's Request

As the story goes, a winegrower approached Flisch asking for a hand-held pruner for his vines. Since he could make such good tools, maybe he could also make one for his special application in the vineyard? The first design, named Model 1, made of forged aluminum, with interchangeable parts, and of high durability, became an immediate success and other winegrowers asked for the same. Before long, an expanding business developed for these pruning shears that have become the leading product for Felco. The follow-on model, Felco 2, looked the same as the original model, but was produced differently. It came coated with the now-classic red handles. The Model 2 remained the company's bestseller since 1948 to this day, producing 3000 daily and retailing at CHF 50, approximately 3 times the price of cheaper imports from Asia copying Felco's design.

Responding to an Electrician's Request

The story surrounding the introduction of cable cutters began in similar fashion. Someone came and said: *You know how to cut branches, why don't you build a tool to cut cables?* In response, Felco created a complete range of cable cutters in 1952 based on a unique triangular cutting approach that allowed cables to be cut but not bent in the process. The Felco cable cutters were used in many different applications, including automobile tire production, aerospace production, and even some large ones used by crews on sailing boats in emergencies.

The Principles Governing all Felco Products

All Felco products had to meet the highest quality standard. Three principles stood out: (1) ergonomics, (2) interchangeability, and (3) durability. On all three counts, Felco products were superior to competing makes.

Ergonomics was critical from the users' point of view. Particularly in vineyards, plants had to be pruned during a limited time window, with professional pruners

performing thousands of cuts a day in large vineyards. Felco pruning shears could allow 10,000 cuts a day without causing injury to the hand of the pruner. Resting comfortably in the hand, of minimum weight, with a spring for effort reduction, were critical features. To achieve the best ergonomics possible, Felco offered products with differently shaped handles, for different hand sizes, for left- or right-handed pruners, as well as handles that could tilt during the pruning action.

Felco's second principle, interchangeability, led in a modular design where individual components were replaceable and could be interchanged if worn out. Interchangeability over long service life of the instruments could only be achieved with high precision over all aspects of production, delivering identical parts even if produced years apart.

Finally, durability was a requirement for long-term service. Felco products were made to be turned over from generation to generation rather than be regarded as a disposable tool with an expiration date. To achieve durability and allow the company to issue a life-long guarantee, only the most exacting manufacturing processes and materials could be used.

Company values supported the creation of the best possible pruning products. Precision cutting also guaranteed *quick healing of the pruning wound* resulting in better yields for the farmers.

Building International Markets Early

Felco Founder Félix Flisch began to search for markets outside of Switzerland from the early beginnings of his company. Export sales commenced in 1946, just 1 year after the company's founding. He took numerous trips, by car, to France, Germany, and into the Benelux countries to bring his tools to the attention of farmers and winegrowers.

To service and support the 120 markets where Felco tools were sold today, the company operated fully or majority-owned subsidiaries in France, Germany, Belgium, South Africa, Canada, the USA, and Australia. The subsidiaries' role was to market the Felco brand and to provide local service and spare parts. In all other countries, Felco worked through distributors who sold many other brands in markets related to Felco products.

To support its distribution network, and to reach its end users, Felco created a comprehensive website with video instructions for the care and repair of its tools, as well as for ordering spares for worn out parts.

Segmenting the Market for Felco Tools

Felco segmented its market space neither by crop (such as grapes) nor by application (such as cable cutting in the electrical industry) alone, but by the function performed by its tools. *Initially, we were only responding to demand suggesting many uses for our tools* (Christophe Nicolet, CEO). Users included electricians in the Netherlands,

tools for rose cutting in Ecuador, the garlic industry in the USA, or for cacao pruning, which took place twice annually and needed easily replaceable blades.

One function that was at the core of Felco's business was pruning. Beyond pruning tools Felco produced tools for lopping bigger branches, cable cutters, pruning saws, knives, and even electric pruning shears.

Aside from function, particular attention was paid to ergonomics: left-handed and right-handed, large hands and small hands, powered assisted tools, etc.

The champagne house Moët & Chandon engages about 500 people to prune its vineyards during 10 weeks early in the growing season. These workers perform up to 10,000 cuts per day. Some 20% of people working in vineyards develop muscular problems in their shoulders over time. This work requires not only a good cutting tool, but also an ergonomic one (Christophe Nicolet, CEO).

Extensive Product Portfolio Aimed at Specific Functions

Felco's product line for its main functional segments of pruning shears, loppers, cable cutters, and pruning saws is extensive. For pruning shears alone, 24 different models were offered, for loppers 14, and 5 different models of pruning saws were marketed. For pruning and grafting knives the company offered 13 models, and 3 models of power tools were also part of the product collection. A number of accessories, ranging from sharpening tools to holsters, rounded off the portfolio.

Maintaining Production in Switzerland

Felco's production base is still in Les Geneveys-sur-Coffrane, the same village where the company was originally founded. The site in the central part of the village, and a few steps from the railway station, had been expanded several times and now included several adjacent buildings. The factory produced about 5000 units of different tools per day.

Felco's was an integrated production with all steps performed in-house and under one roof, with the exception of its aluminum forged handles which are supplied by a separate subsidiary, also Felco owned.

Considerable investment went into manufacturing automation across the entire production of parts, and even some assembly steps. Only final inspection remained a manual operation. Felco fully implemented Industry 4.0 providing regular status of all of its production machinery to the smartphones of supervisors. Applying the 5 S and SMED approach, it practiced TPM maintenance. Because the jobs of its labor force changed over time, the company's in-house training constantly upgraded the skills of its employees to meet the demands of new technology.

Eric Perrin, son-in-law of company founder Félix Flisch and CEO of FELCO from 1974 to 2002, strongly believed in investing in people and keeping local jobs in the Jura region. Aside from some exceptions, no production was moved offshore,

such as China. Some accessories were sourced abroad. The high percentage of Swiss content allowed Felco to brand the majority of its products as *Swiss Made*.

Living with the High-Cost Base of Switzerland

Like many of the other exporters operating in the Jura region, Felco also had to struggle with the high wages of Switzerland and, more recently, with the increased valuation of the Swiss Franc vs. the Euro. In order to compensate for the abrupt upvaluation of the Swiss currency, the company switched some sourcing of primary materials from Swiss importers to buying directly from the Euro area. The workforce helped by agreeing to work 20 extra minutes every day without compensation, a move that saved 4 jobs of the company's 150 workforce.

Integrating Backwards into the Value Chain

Felco followed the policy of bringing key production steps in-house. As part of this strategy, in 1997, Felco became the sole shareholder of Prétat, the only company specializing in aluminum forgings in Switzerland. Since nearly all Felco products came with forged aluminum handles, the acquisition of Prétat was of great strategic value. Prétat did half of its business as a captive supplier to Felco; the rest served other customers, many of them outside of Switzerland. The company was founded in 1947 and had about 65 employees.

From Selling to Marketing and Branding

For the first 50 years of its history, there was no formal marketing function or department at Felco. The major customer and trade facing activities were selling through distributors, building a network of independent distributors in many countries. Starting in 1989, Felco-owned sales subsidiaries were formed in some key areas, such as in Belgium for the Benelux region, France, Australia, Germany, Canada (2011), and the USA (2012). In 2009, Felco created a sales subsidiary in South Africa with 40% ownership from local partners.

The decision to create a formal marketing department was taken by then CEO Laurent Perrin around 2008 when the company realized it needed to better understand its customers. Focus groups and research had determined that the brand was well known and its products were highly appreciated, but the company was not viewed as innovative nor was it perceived as listening enough to its customers. When realizing how many vineyard workers developed muscular problems, the idea of a cordless battery-operated pruner emerged resulting in the Felco 820 model launched in 2012 that could work twice the speed of the traditional Felco 2 with less effort, allowing a user to make up to 20,000 cuts per day.

Felco did not face a single competitor that operated globally in its product space. This, of course, did not mean that the company did not face any competitors. Its most potent competitors were local champions in some key markets, such as Castellari in Italy, Löwe in Germany, ARS & Okazune in Japan, Bahco, and Pellenc and Infaco, both in France, the latter one focusing on electric pruning shears and operating globally in that segment. There were also a number of low-cost competitors from Asia that marketed under OEM agreements for larger retailers.

Creating FELCO MOTION as a Separate Company

Around 2008, Felco management lead by Laurent Perrin also began to reflect on its R&D activities and how many of its key components needed to be made within the company. As cordless battery-operated tools became a must for the professional user segment, Felco decided to launch a strategic project to develop its own line of electric portable tools in-house. After an in-depth study of the market potential and investment needs, the owners gave the go-ahead. Two years later, in 2010, a separate company called FELCO MOTION SA was born with the mission to develop, industrialize, and assemble the entire range of new Felco brand battery-operated pruning shears. To underline this, the board appointed the former Felco CCO, Stéphane Poggi, as CEO and co-owner. He had to report directly to the board, not to Felco management. Besides, Felco Motion was housed in a distinct part of the manufacturing complex. The new company had to hire about 10 microtechnics and electronics specialists. Felco Motion maintained its own small production and assembling, with distribution managed through the Felco network. Frequent contact with Felco management was facilitated by the colocation of all operations.

Entering Partnerships

In 2014, the group entered a wide-ranging partnership with Stihl of Germany, world leader in power saws and lawn care machinery. Stihl, who was into cutting big trees, wanted access to Felco technologies and products for cutting small trees and branches. The board management agreed to a partnership with important benefits for both companies. Stihl obtained access to various Felco technologies on an OEM basis, in return Felco could access Stihl's distribution network. Not satisfied with this trade-off alone, Felco also asked for, and got, access to Stihl's 40,000 points of sales worldwide for its tools. The products marketed through Stihl were being co-branded but produced by Felco and Felco Motion.

The Felco Talent Management Model

Felco drew its staffing mostly from the Canton Neuchâtel region and had almost no daily cross-border commuters from France as was the case with many watch companies in the region.

The Swiss dual apprenticeship system was important to the company; it offered apprenticeships for polymechanics (12 at present, 4 years) or mechanics (3 years) as well as in IT.

Externally, Felco leveraged connections to the EPFL Neuchâtel campus, such as for use of 3-D printers, and regularly hosted students for thesis works. The Federal Government's CIT/KTI projects were also a source of expertise.

A special aspect was the staffing of Felco's finished goods packaging department, which was entirely in the hands of a collaboration with the Canton Neuchâtel program for impaired persons. Different from other companies who availed themselves of the service of similar groups, Felco brought the group of 20 every day to the complex and they worked in Felco uniforms.

Maintaining Family Governance at Felco

Throughout its history, Felco remained a family-owned company. Ownership was in the hands of Félix Flisch's descendants and their families. Félix and Juliette Flisch had one daughter and one son. Flisch managed the company until 1974, when he turned management over to his son-in-law Eric Perrin, who was CEO until 2002, when his son Laurent Perrin took over for the third generation (from 01.01.2003) and remained CEO until 30.06.2011, at which time Christophe Nicolet was appointed CEO, 43 years of age, and after 66 years, he was the first nonfamily member to head the firm.

Although the Flisch and Perrin families were no longer involved in the operative management of Felco, they remained active in the FLISCH HOLDING company, sole owner of Felco and the separate Prétat SA, the acquired supplier of the aluminum handlebars for Felco products, and partial owner of Felco Motion. Through membership on the board of the holding company, the Flisch and Perrin families remained actively involved in the strategy of the group and FELCO in particular.

Felco, as an operating company, had its own dedicated board with at least one member of the Flisch Holding company as well as external board members. General management of Felco was in the hands of three members, with Christophe Nicolet as its CEO since 2011.

Self-Financing as Key

Since Felco was a privately held company with a family holding as its main shareholder, no financial data were regularly made public. According to Nicolet,

CEO, there was little talk about EBIT at the firm level. The main financial parameter was the reinvestment capacity at Felco for new equipment and projects, which was targeted at about CHF 2 mio annually or about 5% of sales. The company did not avail itself of any bank financing or mortgages and was fully financed by the family-owned Flisch Holding.



Exhibit 26.17 Felco product

Company Profile 20: Plaston³¹—From Packaging Solutions to Air Treatment Systems

Global Leader in Industrial Packaging and Air Treatment Systems

Plaston Group, based in Widnau (SG) in the Rhine Valley, consisted of two business units, Plaston and Boneco. The former manufactured industrial plastic packaging solutions and the latter focused on the development and sale of air treatment systems. Synergies existed between the two units as both of them used plastics as raw material, and the Plaston unit also assembled air treatment systems for Boneco. Plaston Group produced and sold both lines globally with plants in Widnau, the Czech Republic, and in China, and a sales subsidiary in USA. The third generation of

³¹This profile was written by Thierry Volery (Professor Zurich University of Applied Sciences and Visiting Professor University of St. Gallen) and Heiko Bergmann (Adjunct Professor of Entrepreneurship University of St. Gallen) on the basis of a company interview and publicly available material. Copyright©2019.

the Frei family was now involved in the business and still owned the majority of shares. The group had over 400 employees and in recent years generated, on average, revenues ranging from CHF 80–90 mio.

Starting Up in a Garage

Hans Frei (1901–1977) founded Plaston in 1956 in his parents' garage. Poor health leads him to leave his job at Viscose, a textile manufacturer. He invested his savings to buy a 60 ton injection molding machine and soon began to produce plastic products for the household market, including kitchen utensils, plastic cups, punch card holders, and other plastic accessories. Criss-crossing Eastern Switzerland by train, Hans Frei traveled from town to town where he met with buyers from major household resellers. He used every opportunity to acquire new clients. Having served as a sergeant in the army, he soon discovered that several of his fellow soldiers owned businesses. It was through this network that he secured early orders while managing to establish a reputation for high quality.

A simple salad cutlery set provided the breakthrough and offered financial security. In the years following WWII, many food manufacturers and distributors made special sales promotions along with a bonus gift. Plaston followed this idea by offering a new “Swedish design” salad cutlery to two major salad oil companies, Sais and Usego, with both companies accepting. This idea was a huge success. Working around the clock, Plaston's small production team produced over 400,000 salad cutlery sets.

Efficient operation of injection molding machines demanded uninterrupted 24-h use. A four-member team consisting of founder Hans Frei, his wife Sofia, their son Roland and daughter Madlen, took up this challenge. Hans and Roland would run production and sell products, while Madlen handled the bookkeeping and looked after the machine during the breaks. Ten-hour shifts were a daily routine, and founder Hans had to deal with a multitude of tasks, including product development, repairing and replacing tools, and meeting with customers.

Finding a Niche in Large Components

By 1961, Plaston had invested in a second machine and needed to move into a new, larger facility. Another son of the founder, Bruno, joined the company. As a process specialist, he had a knack for troubleshooting and spotting new solutions to improve the production process. His knowledge became invaluable to address technical problems, both with production workers and machine suppliers.

The company developed new technology for the demolding process, which led to the introduction of the first container lids with an inner grip. These were still used today on Ovomaltine containers. Plaston formed a joint venture with Sandher to develop and sell new products such as yogurt cups, ice cream cups, and containers. Eventually, annual production reached over 30 million pieces.

In 1966, Hans Frei conducted a strategy review, to define the expansion path for the next decade. It was decided to concentrate on the production of high-grade, durable products for industrial as well as household markets. In addition, Plaston would invest in production machinery to distinguish its offering from the growing floods of small, cheaper imports from Asia. Transportation of large plastic products over long distances was not cost-effective and Plaston decided to occupy this market niche. Soon, the production facility reached maximum capacity and a new plant was built.

Development of Air Treatment Systems Under the Boneco Brand

Plaston's involvement with the air treatment system, branded Boneco, began in the late 1960s with the production of radiator evaporators intended to be placed on heating radiators during winter. Roland, one of the founder's sons, was as a student at TU Aachen's Plastic Institute in Germany and chose the development of an air humidifier as his thesis topic. He focused on air humidifiers which use heat from radiators to raise the humidity levels in interior rooms during the heating period. Soon, the first radiator evaporator was launched under the Boneco brand. The evaporator was suitable for all common radiator models and could be easily hung on the heater. It became an immediate sales success.

The radiator evaporator business was undertaken on an OEM basis on behalf of a Swiss client distributing household and kitchen tools. Around 1967, when a French company supplied the first electric-powered humidifier through the Migros chain, the OEM client asked Plaston to develop such an equipment. Plaston accepted the challenge only to realize that there were many other suppliers of steam humidifiers.

Over time, Boneco developed a range of air treatment products that washed, humidified, or purified air and included the ultrasonic humidifier, the ionizing air washer, the basic air washer, the portable air humidifier, and the portable air purifier. All were small appliances designed for use in homes, offices, dormitory rooms, or other similar spaces.

A typical product use was the treatment of dry winter air in a home or apartment. The purifier removed airborne particles in a 70 m² space as fast as every 12 min via an active carbon filter that absorbed odors and harmful fumes. The air washer cleaned air by using water as the filtering medium and required no replacement filter. It used a combination of ionization and water filtration to clean room air of particles as small as 0.5 microns.

For years, Plaston stayed with OEM agreements for Coop, Migros, and Philipps. When the Coop chain approached Plaston that they could not possibly sell the same product as Migros, Plaston began to withdraw from the OEM arrangements and to increasingly use the Boneco brand name for its range of air treatment systems. Sales to other regions, such as Asia and North America, were pursued to hedge against the risk of mild winters which could depress sales.

Eventually, air treatment products accounted for a significant part of Plaston sales, prompting the company to adapt its organizational structure accordingly. In

1991, Plaston Holding was created, incorporating the two business units Air Treatment Systems and Industrial Plastic Systems. The purpose was to grant greater operational flexibility to both units. In the same vein, a separate company, Boneco AG, was set up in 1993.

However, the progression of Boneco never met the expectations of the owner-managers. Boneco management intended to offer a steady assortment of products. The result was that the finished products purchased from Asia were so bound up by approvals and service that the company neglected its own product development. This led to a major reduction in the number of air humidifiers produced by Plaston. Following numerous issues around quality control on the part of the Asian suppliers, Boneco was reintegrated into the Plaston structure.

Gaining Hilti as First Key Account in Packaging

In the 1970s, Hilti, already a leading manufacturer of power tools and anchoring systems and based in the Rhine Valley about 30 min down the road from the Plaston plant, had made the decision to close its in-house plastics laboratory, offering its equipment to Plaston. During a visit to the Hilti warehouse, Hans Frei discovered a mountain of red metal cases used to package Hilti power tools. *These cases could also be made out of plastic* said Hans Frei. Hilti answered, *We already have enough problems with our power tools, we don't want to add more problems with the cases.*

Hans Frei did not take no for an answer. For the next 2 years, together with his son Roland and a small, dedicated team, they worked to create a series of prototypes with the hope of impressing Hilti. Hilti finally agreed that Plaston could produce cases for one of their power tool models, at its own risk.

Hilti's corporate decision to sell its complete line of products in specially designed Hilti cases made by Plaston was confirmation and challenge at the same time: confirmation, because, once again, determination and power of persuasion had won; challenge, because the scope of this project went beyond anything Plaston had undertaken previously. Three additional product lines for Hilti followed in 1980, 1990, and 2005. By 2010, 40 million cases had been sold, and the fifth generation of cases was under development.

Building a Base in the USA

The number of case customers in the US market was steadily increasing since the early 1990s, and with it, the need to consider the option to supply cases locally. Based on previous experience, Plaston sought partners on the East and West Coast who could handle a flexible supply concept, involving both production and delivery. However, increasing cost pressure necessitated the relocation of production facilities to more cost-effective areas, from North Carolina to Arkansas, and to Mexico. Eventually, Plaston withdrew from the production partnerships in the USA.

The US market for air treatment systems was, however, more promising, and in 1997, Plaston set up a sales subsidiary with three employees in Naperville, Illinois, a suburb of Chicago, to market Boneco products. They chose a limited number of products in order to avoid the risk of unsold inventory piling up, selecting only those with the best chance of success. After about one year, Plaston began to use several independent representatives for the Midwest and the East Coast. Eventually, Plaston landed a contract with Bed Bath & Beyond which operated some 650 stores throughout the USA. Plaston sold humidifiers and air purifiers through more than 500 of these retail outlets. Volume exploded and the company soon achieved double-digit growth within a few years.

Following Bosch into the Czech Republic

In 1985, Bosch became the second key account for packaging systems. A distinguishing feature of the new Bosch case was the introduction of a full-size image, in relief printing, of a drill machine representing a true innovation at the time. In the early 1990s, Bosch inquired if Plaston would consider producing cases closer to its factory near the German/Czech border. The project in Šluknov rapidly took shape. Plaston acquired an existing 5000 m² production facility in 1995 and soon began to produce its first cases. This plant operated continuously at three shifts to this day.

The decision to produce in the Czech Republic not only strengthened the relationship with Bosch, but also contributed to the development of air treatment products for Plaston. Building electrical appliances involved considerable amount of assembly work and the Šluknov (CZ) location offered access to both a qualified and competitive labor pool. Lower manufacturing costs, combined with items purchased in Eastern Europe, allowed Plaston to support building its foothold for Boneco products in the extremely competitive US market.

Following Hilti into China

In 1994, as Plaston was still in the planning phase for its factory in the Czech Republic, Hilti disclosed plans to establish a production facility in China, requiring cases to be produced in China. Plaston management decided to take up the challenge. A year later, the Hilti case production was installed in a local state-owned enterprise. However, operations at the newly established Plaston Zhanjiang Ltd did not proceed smoothly. Plaston faced numerous challenges in dealing with government regulations, power outages, and staffing requirements of the state-owned business. At times, it took ten people to produce a single case. After just 3 years, the decision was taken to close Plaston Zhanjiang Ltd.

This first venture into the Chinese market cost Plaston dearly, but it also provided the company with an invaluable experience. This false start did not dampen Plaston's ambition to create a foothold in China. A breakthrough came in 2004 with the

construction of a wholly owned production facility in Jiaxing near Shanghai. Roger Bitterlin, the then production manager of the Plaston factory in Widnau, Switzerland, moved to Jiaxing to become the new plant manager there.

Refocusing the Strategy on Packaging and Air Treatment Systems

In the early 1990s, Plaston management conducted a strategy review assisted by faculty of the University of St Gallen. Three themes were evaluated: the impact of political changes in Eastern Europe; the impact of social, ecological, and technological developments; and the choice of product-market positioning. The owner-managers amended the company strategy, deciding that Plaston would produce close to its customers. Transportation over long distances could not be justified economically and ecologically. This new strategic positioning led to Plaston's internationalization.

The second theme of the strategy review concerned changes in consumer behavior, the ecological and technological environment, and the resulting effects on Plaston consumer products. At that time, the company produced numerous consumer products for kitchen and household use, storage systems for CDs, office-organizing systems, and air treatment systems under the Boneco brand. The growing demand for updates in product design every 3–5 years made it increasingly difficult to break-even on the investment in development and tools. Plaston management therefore decided to completely withdraw from household products, storage systems, and office organization systems and to focus its consumer business on the production and distribution of air treatment systems.

At the turn of the century, Plaston was the leading global provider of high-quality plastic packaging solutions. Plaston's mission was to provide close customer relationships, quality products, and innovation geared to meet customer needs. The company stated *the customer is always the focus for us, and our most important asset is our motivated and highly skilled employees.*

In the eyes of Plaston, the best plastic product could only be as good as the service that went along. That is why Plaston placed such importance on providing a comprehensive service experience, with customer needs taking center stage. Service was based on both personal communication and a customer relationship management system. It covered the entire value-added cycle from development and production to logistics. This all-encompassing service shaped how employees thought and acted. Plaston's Service division followed every product through its entire value chain.

Innovating Around Products and Processes

Innovation at Plaston took a variety of forms. There were product innovations mainly driven by customer demand with many products "cocreated" with key accounts, such as Hilti and Bosch. Process innovation was enabled through

cooperation with machine manufacturers. Plaston worked closely with Swiss-based Netstal, one of the world's leading suppliers of high-precision, high-speed plastic injection molding machines. In addition to hardware, Plaston invested in computer-aided engineering (CAE), expanding its use of plastics simulation. Such investments led to in-depth simulation capability and significantly reduced mold development time.

Occasionally, Plaston tackled white space opportunities focused on disruptive innovation and new business category development. For instance, Plaston developed a solar roofing tile as part of Newtec, a project supported by the State Secretariat for Economic Affairs (SECO). The new technology was successfully pilot-tested but shelved in 2011 as demand for solar energy could not justify the production costs of these tiles.

Process innovation was spearheaded by a team of a dozen engineers, based at headquarters, and working closely with the subsidiaries abroad. The team would work on research, development, and design. However, Plaston would often cooperate with external partners, such as Universities of Applied Sciences, as part of Innosuisse projects. Innosuisse was a Swiss federal agency, which covered the research partner's salary and, under certain conditions, material costs, as well as a contribution toward overhead. The company provided at least matching funds.

Opening Management to Nonfamily Members

Plaston had remained a family-owned company from 1956. A first generational change took place in 1973 when Roland, son of company founder Hans Frei, took over management of Plaston. Roland Frei had been working at Plaston for 16 years before becoming CEO and ran the company until 1999, a career spanning 42 years with the company.

Following Roland Frei's retirement, Jan Dobrý was appointed the first nonfamily CEO. Jan Dobrý was very familiar with Plaston's business as he had been Group Controller and subsequent CFO of the company. Dobrý led the Plaston Group for 13 years and then Markus Bormann, another nonfamily member, succeeded him as CEO. Before his appointment, Bormann had been the leader of the Industrial Plastics Systems unit for 10 years. Alexander Gapp later succeeded Markus Bormann as CEO.

Keeping Majority Ownership in the Family

Until 1990, Plaston had been entirely family-owned. The strategic objective was to restrict share ownership to those who would, or could, have a direct influence on the company's future success. As a result, it was decided to purchase the shares of the four sisters of Roland Frei. The newly available shares, representing 35% of the capital, were placed with existing members of management. This move was designed to strengthen the awareness of the mutual goal of keeping Plaston on the

road to success. In 2004, Plaston decided to go public and list its shares on the secondary market. The Frei family still held over 54% of shares, with the rest of shares being held by management and a small group of investors.

The role of the board of directors did not alter much following the death of Hans Frei in 1977. His son Roland then became president of the board. For the first time, senior management and nonfamily members were represented on the board. Subsequently, the role of management and oversight roles were separated. As a result, board members were no longer allowed to hold a management position and vice versa. In 2013, Roland Frei's son Jörg became chairman of the Plaston board, representing the third generation of Frei family members at the helm of the company.



Exhibit 26.18 Plaston product

Company Profile 21: EAO³²—Global Experts in Human-Machine Interfaces (HMI). Push Buttons Withstanding Over Ten Million Touches over Their Product Life

Visiting the Modern Building Next to Olten Train Station

Visitors to the EAO Head Office will have to look for the building right along the railway lines on the southeastern end of Olten Station, one of the busiest train hubs of the Swiss Federal Railway system. Thousands of train passengers pass the station

³²This case was written by Jean-Pierre Jeannet (Professor Emeritus Babson College [USA] and IMD Institute [Switzerland]) on the basis of a company interview as well as publicly available information. Copyright ©2019.

and are likely to overlook the building located at the edge of the track. And few probably realize that inside that building, engineers and product assemblers build the controls for human-machine interface (HMI) applications that, among others, opened the doors for them to board the train. With sales of about CHF 130 mio and 650 employees worldwide producing some 30 million units annually, EAO became a global powerhouse for demanding HMI applications in many sectors and used daily by people all over the world.

Two Friends from School Started an Electrical Transformer Business

Kurt Loosli (1921–1988) and René Thalmann (1921–1993), two school friends from Olten, combined their efforts and resources to found EAO as a small electrical workshop in Olten in 1947, in premises owned by Kurt Loosli's father. They shared ownership of the business on an equal basis.

Kurt Loosli grew up in Olten where his father was owner of an electrical shop. He trained as an apprentice completing today's equivalent of a polymechanic apprenticeship and continued at the Burgdorf Technology Institute (HTL) for a degree in electrical engineering. His education completed, and he returned to Olten to open up the business with his school friend René Thalmann, also from Olten, who had joined an international telecommunications company (ITT) near Zurich. Thalmann, living in Olten and working for a salary, supported the fledgling company financially from the beginning.

The pair began their business making transformers, at first for trains, later for electrical junction boxes. They moved into an old factory workshop near the train tracks of Olten station, not far from where the EAO buildings were to be built later on. They established a reputation for transformers used in electrical boxes.

A Customer Suggestion Leads to a New Business

One day, the maker of electrical junction boxes who sourced transformers from the two told them about his problems with switches in his boxes. Both saw an interesting business opportunity as Thalmann knew something about switches and push buttons from his time at ITT. Approaching the challenge with an innovative spirit, they developed a push button made from new plastic materials, with a small lamp fully incorporated, rather than apart as was then standard, and finally miniaturized it to a new standard compact size. There were no such products with that combination of features on the market in 1958.

The lighted buttons were a success, and the reaction of the pair was: *Let's go and make some more*. The challenge was the manufacturing of plastic parts, something Loosli and Thalmann were not familiar with. They found local injection molders, and to this day, EAO continued to source its plastic components from Swiss molders. The suggestion of the electrical box maker, and the response of Loosli and Thalmann, eventually led to the products around human-machine interfaces (HMI) that became the dominant business of EAO.

Company Founders Passing Away Led to Business Split

When co-founder Kurt Loosli passed away in 1988, his widow Dora Loosli inherited the 50% stake in the company. The couple had four children; none of them were in the business then. In 1993, co-founder René Thalmann died, and his widow inherited the other 50% stake in EAO. At that time, total sales of EAO amounted to about CHF 90 mio.

The two widows and their families were confronted with what to do about the company. The Thalmann family decided they wanted sell, while the Loosli family decided to stay in the business. Rather than one family buying out the other, the two owner families settled on an asset split. To make this work, the Thalmann family took all noncore business assets, from the real estate to excess liquidity. The Loosli family ended up with the direct business assets but limited liquidity which made running the divided business a challenge.

The Second Generation Stepped in

When the Loosli family assumed sole control of EAO in 1996, the majority of the shares were owned by the widow Dora Loosli. To involve her four children, each became a minority shareholder on an equal basis. The oldest son had already joined the family company just after his father's death in 1988. The youngest, Kurt Loosli, Jr., entered the EAO business starting as Chief R&D Manager in 1997, becoming CEO in 2001, while his older brother concentrated on the commercial side of the firm.

Kurt Loosli, Jr., studied at the ETH Zurich experimental physics, solid-state physics, and magneto-optics. After graduating, he joined the Swiss firm Ascom Microelectronics, dealing with semiconductor electronics and sensors, where he rose to the position of product manager. After earning his MBA at Manchester Business School, he joined Arthur D. Little (ADL), Switzerland, where he stayed 3 years as a management consultant, becoming Senior Consultant. He entered the EAO in 1997.

Focusing the Company on HMI Applications

When Kurt Loosli, Jr., joined the company, the product portfolio included a wide range of products. Older generations of transformers were still produced next to a variety of platforms of command and control devices, primarily illuminated push buttons. The company decided to sell off all its noncore businesses, including transformers, and to concentrate exclusively on command and control devices.³³ The company's new vision was to completely open up the existing range of switches and to become a leader in HMI products, a business segment that had not yet

³³The spun-out transformer business continued to this day under different ownership.

completely evolved. Leadership did not mean largest in volume but best in quality, fully addressing all possible interfaces based on the three human senses of feeling, hearing, and seeing, while strongly focusing on applications within most demanding environments.

With that new vision, EAO decided to concentrate on niche applications where both suppliers and customers needed to comply with multiple standards and to go always for the top segment. In some of EAO's chosen applications, certification was hard to secure and represented a high entry barrier. The key features of EAO products included sound emittance, illumination, originally incandescent now moving toward LED lighting, compactness, and miniaturization. Once installed, a push button had to be capable of surviving over ten million touches over the life of the product.

Technologically, HMI buttons were at the intersection of mechatronics, electrical, mechanical, and software technologies. The plastic components had to be molded to a precision of 1/100 mm, placing great demands on molding operations and miniaturization.

Modularizing the HMI Product Platform

All HMI models were made up of a large number of combinations built on the basis of about 15,000 individual components, with the number of possible combinations going into the millions. This complexity was mastered by establishing a modularized product platform, offering customers a maximum number of variations, resulting in customization at virtually no additional costs to them.

EAO product overview listed the following categories, from which different combinations were possible:

- 24 different basic platforms (series) of HMI functions
- 18 different functions provided (indicators, buzzers, etc.)
- 11 different protective designs
- 8 different VAC ratings
- 7 different mountings cutouts (diameter sizes, in mm)
- 9 different connection terminations (soldering, etc.)
- 4 different lens materials (plastics, steel, aluminum, etc.)
- 3 forms of marking (laser, engraving, stamping)
- 15 different approval standards (UL/UR, etc.)

While not all theoretical combinations were in use, the possibilities were such that customers needed the company to assist them with configuring their requirements. To take this one step further, EAO launched a digital catalog, web-based, and computerized, to make it easier for customers to select the right combinations. Some 30% of EAO sales were for customer-specific combinations.

Top seller among EAO products was the buckle switch that was incorporated in the buckle of the seat belt system to prompt drivers or passengers to put on their seat belts. Launched in 1996, the company was selling as many as 22 million units annually, produced from fully automated production lines.

Creating a Dedicated Value Chain

The large number of elements at the basis of a modularized product platform with almost unlimited combinations required a dedicated value chain in line with the product line configurations. EAO did not produce its own plastics injection molding and metal stamping components. Instead, the company focused on four core value generators, primarily on (1) product development with customers, (2) dedicated expert supplier network, (3) automated assembling with in-line quality testing, and (4) its worldwide sales and customer service network. The product parts were sourced from specialized suppliers, the majority coming from Switzerland or Germany. The all-important plastic components were sourced from Swiss injection molders.

Among its four manufacturing operations, the Swiss plant in Olten was a major assembly point. The operation in Germany carried out the assembly for automotive applications and off-road vehicles. The US assembly operation was geared toward public railways projects where local content was important. China was described as the “workbench” for assembling standard products based largely on imported components, as well as serving local Chinese customers with localized HMI products.

As a heavy user of tools and molds needed for its plastic material converters, EAO owned most molding tools, but they were located at the suppliers for their use. Transferring these tools abroad would be slow due to their weight and dimensions. Consequently, plastic conversion operations and mold suppliers were largely based in Switzerland.

Narrowing Its Segment Focus

EAO segmentation and segment selection strategy was built around depth rather than width. The company was interested in a few global application segments by offering products for many standards within those segments. Its primary segments were Railways and Transportation, Automotive, Machinery, and more recently Heavy Duty and Special Vehicles. The requirements for its HMI control devices differed by application segments as well as within each segment.

For Railways and Transportation, EAO offered products for driver cabs, passenger access, toilets, and for rail infrastructure. Product certifications, intuitiveness, and ergonomics were important customer requirements, as well as longevity as trains were kept in operation for as long as 30 or 40 years and operators expected replacement parts over the lifetime of the vehicle.

In the segment Machinery, covering many divergent user industries, products differed whether intended for an operator station, for a handheld device, or for a multitude of operator panels. Customers were looking for reliability, precision, efficiency, and safety.

EAO was equally clear which segments were outside its focus. The company had said no to white goods applications, no to consumer goods applications, no to aerospace (largely due to a different quality management system), accepted very few medical applications, and declined to enter the defense segment.

Integrated Product Development Process

New products, or configurations, were developed at each production site. It involved different talents, such as mechanical and electrical engineers, specialists in material science, and some software developers, as well as product managers and production specialists.

The team proposing a new product was tasked to put five core value propositions on a single page and not to create a large book of technical specifications. The key questions to be answered were: *Who is pushing the button?* and *Why is this person pushing the button?* The user's task and the user's experience were always at the core for new products, ever since the two founding pioneers started EAO.

Expanding Sales and Marketing Footprint

EAO began early with exports and international sales, and export efforts benefited from early internationalization of its product line. Exports to Germany commenced in 1965, followed by sales to the Netherlands (1967), the UK (1972), North America (1978), and to Asia (Hongkong) as of 1980. About 95% of all products assembled in Olten went into exports. EAO products were used in some 50 regions or countries.

The EAO business model relied on direct sales, with eleven sales companies across the world. A sales force of about 50 people, spread out globally, tended to its customers. EAO was of the view that sales contacts needed to be held by people rooted in local customs. Trained resellers were only accepted in countries with sales potential clearly less than CHF 4 mio, the critical threshold for opening a company-owned sales office.

Exports to China dated back 30 years. In 2004, the company also moved some product development roles to China and added assembly operations. Despite the long-standing contacts, building business connections to state-owned companies remained a slow process. As of 1993, EAO was also present on the Japanese railroad market, with an 80% share in the Japanese market for door opening push buttons, the result of customized solutions and extremely high service and delivery responsiveness.

The globally spread sales force kept in touch via sales call-ins every 3 months and an annual 2-day sales meeting. Direct links among sales teams and sales companies were encouraged to avoid that communications had to go through the center in Olten. Global teams called Centers of Competence (CoC) were in place for key markets that were global in nature, such as railways, heavy duty, and machinery. These teams worked on a global level to formulate market strategies, on management of key customers, product innovations, and sharing of sales opportunities and know-how on global accounts. All data needed for the sales force to be successful were on the company's integrated, cloud-based CRM system and could be accessed globally by all members of the sales teams, by the worldwide customer service teams, and by management. Sales were asked to register any new customers, any systematic developments of spotted opportunities, quotes, and complaints to allow for the continuous monitoring and management customers' activities on a global level.

Beating Competition

EAO faced two types of competitors: generalists and specialists. Generalist competitors were usually large international firms, such as Siemens, Schneider, Rockwell, Allen Bradley, or Fuji Electric. For these firms, HMI devices were an add-on to their main business. They operated with a limited product portfolio, performed little or no integration of their products into panels or boxes, and were competing on price.

Specialist firms competing with EAO were usually smaller and in some ways focused as well. Rafi of Germany, twice the size of EAO, was an integrated manufacturer producing its own components. Other firms had core businesses other than HMI's or were active in a limited range of applications only.

EAO was competing in the most demanding application segments with the highest quality products. It distinguished itself in terms of offering the broadest HMI product portfolio, high delivery responsiveness, precision, and short cycle time in the development of special product orders.

Competing for Talent

EAO was a firm believer in the Swiss dual system. The company maintained apprenticeship programs in 18 different professional sectors. Recruiting was also done at two locations of regional Universities of Applied Sciences: in Olten (SO), where a large campus existed, and in Windisch (AG), which had a strong program around plastic molding.

When a difficult or unknown technical problem occurred, the company would outsource the resolution of the issue to external engineering consultants rather than hiring new experts, building a long-term expert network.

Being Self-Reliant on Financing

When the two company founders passed away EAO was debt-free, because the company had traditionally relied on self-financing. After the asset split into two companies, EAO and its HMI business had to live through more difficult times since the bulk of the company liquidity had been spun off. Regardless, EAO relied on external financing for current or short-term needs only. When building up the automotive segment which required a considerable investment, EAO turned to loans for the 3-year development and ramp-up period.

Maintaining Family Ownership and Governance

The company operated two holding companies. The Loosli Holding AG had only family members as shareholders. Loosli Holding owned the EAO Holding AG, which included four professional external board members as well as, in the position of the delegate of the board at EAO Holding, Kurt Loosli, Jr. The recruited external

EAO Product overview/HMI Functions



board members each brought special professional skills to the deliberations: a CEO of another company, a CFO, one person with IT experience, and one with dedicated HMI experience. The Chairman of the EAO Holding was one of the external board members, with the objective to advance the business successfully in keeping with the spirit of the family founders and family shareholders.

I tell them, even as the son of the founder, my performance must be judged like that of any external CEO's (Loosli).

Company Profile 22: Selectron Systems AG³⁴—From Generalist to Specialist. International Niche Player in Train Control Systems

Becoming a Provider of Electronic Train Control and Monitoring Systems

Tucked away in an industrial park in the town of Lyss, halfway between the cities of Berne and Biel/Bienne, two modern buildings were the buildings occupied by Selectron, a small company operating internationally with a staff of about 160, 80% of those engineers and technical specialists. The building exteriors hardly indicated that inside were hardware and software specialists at work to create electronic controls that managed the safety and operation of modern trains, both commuter and intercity models, and also for locomotives, trams, monorails, and metros. Train operators and passengers both relied on these automatic and integrated train control and monitoring systems (TCMS) to control everything in a train, from ventilation to illumination, doors, wet cells, traction and wheel control, and many other functions. Some 20,000 rail cars equipped by Selectron TCMS circulated from Europe to China and the Americas. Despite several ownership changes during its history, including an attempt to liquidate the company, Selectron had experienced considerable growth in the past 15 years with sales estimated surpassing CHF 65 mio in 2018.

Beginning in Automation Components

Selectron was founded in 1956 by Paul Stegmann, a local entrepreneur from Lyss. Stegmann capitalized on the surging demand for electronic controls in machines and equipment previously controlled mechanically. Industrial customers needed automation components, such as Programmable Logic Controls, PLCs, and other input–output devices, IOs, to incorporate them into machine control applications. There were plenty of machine operating companies in the region eager for a supplier to put these elements into machine tools and other production machinery. Companies such as Maillefer, OC Oerlikon, Victorinox, and LNS adopted Selectron components into

³⁴This profile was written by Jean-Pierre Jeannet (Professor Emeritus Babson College [USA] and IMD Institute [Switzerland]) on the basis of company interviews as well as publicly available information. Copyright©2019.

their equipment. Others, in the building control business, were Landis+Gyr, Luwa Air, etc.

Selectron customers appreciated the close contact between their own machine designers and Selectron staff, resulting in a customer portfolio largely concentrated on machine builders in Switzerland and Germany. As the company grew, Selectron integrated backward to assemble its own electronic boards and circuits. The company delivered fully assembled PLCs with software to its customers. Selectron had even developed its own proprietary operating system and software programming tools, all dedicated to its own electronics. By 1992, sales had grown to reach a high point of CHF 30 mio. Employment was at 175, with more than half dedicated to the manufacturing operation.

International Competition Began to Take a Toll

From the early 1990s onwards, Selectron's fortunes began to decline. Large international competitors from Germany, the USA, and Japan began to impact negatively on its business. These competitors entered the Swiss market with standard controllers at much lower prices, made possible by their higher volume. Selectron's customers, when considering new projects on new equipment, began to adopt international controllers, leaving Selectron the business of those firms who either had very small volumes or were unable to provide the integration of standard controllers on their own. Selectron technical staff, particularly on the software side, were eager to provide help for less technically experienced customers. With unit volume still in decline, the time-consuming development assistance was eating into the company's profitability.

Over a period of a few years, sales of Selectron steadily declined to half of the peak sales reached earlier. In addition, factory capacity utilization declined, creating significant overhead absorption problems. Selectron's founder, unable to engineer a turnaround, decided to sell the company, stepping down from all management and ownership functions.

Moving from Desired Acquisition Target to Corporate Stepchild

The corporate suitor who acquired Selectron in 1998 was the Swiss industrial company SIG. SIG had begun to build up its packaging and bottling technology unit with the aim of creating its own motion control and automation tools. In the same year, SIG acquired a German company, Berger Lahr, in the field of motion control, and in 1999 assigned Selectron to report to the German firm which had about Euro 100 mio in sales. Difficulties soon arose when the two companies attempted to integrate their different control systems and software languages into a single system. Within 2 years, SIG changed its strategy and moved away from developing its own control system to sourcing controls from the open market. There was no use anymore for Berger Lahr and Selectron within the SIG group.

The change in SIG strategy meant that the German company was put on the block. In 2001, the global French firm Schneider Electric, a major player in low and medium voltage circuit breakers and automation components, was interested in combining its product line with Berger Lahr. Given earlier experience with merging program languages from different producers, Schneider was not interested in the Selectron business. SIG, however, would sell the German company only if Selectron were to be part of the deal. In the end, Selectron became an unwanted subsidiary of Schneider. The new French owners had no interest in its technology, nor were there any synergies to its business. Without a suitor to buy the operation, Schneider decided to liquidate the company instead.

The task to wind down the operation fell to Emmanuel Hannart, a senior corporate manager at Schneider with long experience in the electronic component industry, and in project and quality management in particular. In his early 50s, Hannart arrived in Lyss to assume the role of CEO and found Selectron in a fragile economic condition. The company employed 160, incurred steadily growing annual losses, reaching some CHF 2 mio, and sales in free fall. Accumulated losses had consumed half of the company's capital, much of it due to an underutilized electronic components factory.

Since Schneider had other businesses in Switzerland, the task of winding down Selectron had to be handled with care to protect the corporate reputation of Schneider. Hannart reckoned that to accomplish this task within 18 months, to close the factory, to pay all penalties to customers and laid off staff would cost about CHF 40 mio, including loss of goodwill. An extension of about 6–12 months would allow to achieve the same goals and possibly break even. Eventually, Schneider relented and granted the extra time. Due to the accumulated losses at Selectron, Schneider had to provide a loan of CHF 10 mio to allow for the operation to continue.

Searching for a Focus

One of the first tasks undertaken by Hannart was a review of Selectron's existing business and segments. Visits to key customers in the three segments of machine tool controls (70% of sales), building controls (15%), and a small business accounting for 15% and supplying train electronics to the Swiss railway for refurbishing made clear that the company did not have a competitive advantage in its two main segments accounting for about 85% of sales.

Without any significant synergies between the segments, each segment was vying for attention from the central development function. However, when comparing profitability, the railway business outperformed the other segments since it required only a small sales team of three. By the end of 2001, after a few months at the helm of the company, Hannart realized that tough choices had to be made. Selectron recorded sales of CHF 11.5 mio, an order intake of CHF 10.3 mio, and an EBIT of -9.5%.

Selectron's competitiveness as a supplier to the Swiss Railway was based on its willingness to varnish the electronic controls and select ruggedized components to

meet the stringent requirements for train operation, and the fact that in the past, to compete in the machine tool automation segment, the company had consistently reduced the size of its controllers to fit into the tight spaces of railway cars. If the PLCs were not varnished, the reliability of the equipment was not assured. Condensation caused by temperature differences and dust collected from steady use could result in short circuits in the system. Major automation suppliers were not interested in taking this extra step and would force the railway operator to use heavy protection boxes instead.

Focusing on the Train Automation Segment

Hannart convinced and directed Selectron staff to stop accepting any new projects for machine tool automation and to stop any sales effort to the building automation segment. Efforts were to be concentrated on the railway automation segment as the Swiss Railways had placed a 5-year contract to supply control units for a large refurbishing contract for older rolling material. Stopping efforts in off-target segments would not lead to layoffs, he argued, since the freed capacity in development and sales were needed to drive the effort in the railway segment labeled “In-Train Automation.”

The focus on the train segment was not without challenge internally; staff pointed out the difficulty of meeting rail operator technical requirements for “ruggedization.” New European regulations (EN 50155) required for electronic controls to withstand operating temperatures from -40C to +85C, compared to 0C to +50C for normal applications. Controls had to be vibration and shockproof, protected from interference, withstand humidity in tunnels, all of which would not be delivered from standard control suppliers. Selectron staff believed that the company was possibly too small to be trusted to achieve this.

The train business in Europe was dominated by the big three global players, Siemens, Alstom, and Bombardier, who accounted for 50% of the volume. These companies had their own operations for developing and producing in-train controls and did not offer a steady market for an independent niche supplier.

The other half of the industry was a growing number of smaller, mostly regional, players, such as Talgo and CAF from Spain, and Stadler from Switzerland. Some of them did not maintain their own train electronic production or development units and had to rely on independent suppliers to avoid buying these systems from their major competitors. When sourcing train control systems, these regional companies faced the dilemma of deciding on a specialized supplier, or to develop their own systems, or to buy standard industry PLCs and put them into special boxes. If Selectron were to master the EN 50155 standard, the company would be able to target these smaller independent train builders. Successful implementation would gain access to the segment of new train installations and construction, not just refurbishing.

Freeing Resources to Finance Restructuring

Selectron's own integrated manufacturing operation had become a drag on its resources. Operating below capacity, Hannart convinced his team that the assembly of components on printed circuit boards was not critical to their success, only tied up critically needed capital, and required large chip volume to be efficient. To subcontract chip production represented a cultural revolution for Selectron staff who had used the in-house manufacturing skills as a sales argument. Hannart prevailed and focused the firm on R&D-driven innovation.

With the help of the local government, he found a buyer who, for a CHF 1.00 fee, assumed all contracts for the electronics component factory and its 100 employees, as well as renting back the building from Selectron. Selectron committed to source its components from the new owner, but only if quality met specifications. Making this move, Selectron could rid itself of the largest source of its losses and was now down to a staff of 60. With this staff, the company could focus its activities on innovations, sales, and customer support.

One year into the turnaround operation, the financial perspective of Selectron had already changed. The company now expected sales of CHF 10.4 mio with an estimated EBIT of 3.5%. Projecting sales growth in the railways segment to eventually become 80% of company sales of CHF 20 mio within 5 years, an EBIT of close to 10% appeared within reach. Meeting such aggressive goals would require the mastery of EN 50155 standard and entail a research and development effort of up to 20% of projected sales.

Developing New Generation of Controls

To meet the new European Union standard EN 50155, Selectron had to develop a new generation of controls. This development effort required a substantial increase in development expenditures that would reach 15–20% of sales, a considerable effort for a small company. A substantial amount of resources had to be invested in testing and laboratory equipment that could simulate all use conditions encountered in real train operating situations. Aside from the hardware, new software had to be developed and also extensive documentation and training manuals.

For locomotives, the control system had to be able to integrate the driver cabin controls, as well as a full range of safety devices, traction control, brake controls, skid/slide controls, and diesel locomotives required added engine and gear controls. For a commuter rail system, up to 12 different controls were placed throughout the train including a CPU system and a number of decentralized controls for subsystems and different applications. A reliably working train control system would become the central nervous system of the next generations of trains.

Clashing with Parent Company on Business Model

As Selectron managed to bring out its new generation of train control systems and pivot its sales and development effort toward the train segment, company sales increased significantly to reach CHF 24 mio by the end of 2007. Train control systems made up some 75% of sales and more than compensated for the decline in nontrain business. As profits increased steadily and consistently to 15% (EBIT), Selectron paid back most of its bridge loan received from the parent company and could even pay dividends to its corporate shareholder.

Despite the impressive turnaround of the company, significant differences existed between Selectron and the Schneider corporate management in Paris. As Selectron presented its ambition to grow to CHF 33 mio in 5 years, most of this in train controls, requiring a further increase in R&D to a level of 20%, the corporate owners balked. They found this level of R&D unacceptable as it was outside their own experience and business practice. Selectron requested to be given freedom to source its own components, whereas Schneider wanted them to buy Schneider components only. Concerning the need to be EN 50155 certified, Schneider countered that that market was too small. Selectron's direct sales to OEM customers were also in conflict with Schneider's typical business model of selling via wholesale partners.

Pursuing Independence

As the conflicts and disagreements about Selectron's strategy with Schneider increased, Hannart came to the conclusion that independence from Schneider had to be pursued to let the company realize its own opportunities. Making several trips to corporate head office in Paris, Hannart managed to win the right of selling himself to a new owner against the resistance of upper-level management who did not want to lose the growing profits now part of their budgets. Eventually, green light was given and a price corridor of about 8 times EBITA was agreed.

First, Hannart considered a buyout with his management team, avoiding the corporate allocation of 10% of sales for overhead was tempting. But the management team was not confident to pull it off and wondered about customer reactions. Who would trust such a small player for such critical components as train control systems?

The other avenue considered was becoming again part of a larger business, but this time with owners who had experience in the train business and understand the implications. The choice eventually fell on ABB. This company had a strong train business and history, was also into automation control, located in Switzerland, and would be able to communicate well with the Selectron team. The negotiations proceeded rapidly, and a price of CHF 19 mio was negotiated that met the Schneider expectations. Unfortunately, one week prior to the final agreement in November 2008, ABB changed CEO and views suddenly changed, too. The new ABB team believed that the company's own control capabilities would allow it to enter the train control business without any acquisition. In the midst of the general economic situation under stress from the Lehman Brothers crash, the deal was called off, and Hannart was back to square one. Schneider's response was to try again.

Employees Buy Out the Company

When the sale to ABB failed, Hannart took another look at the buyout option. Working with business contacts and private investors he knew from before, he and his advisors put together a package for all employees, not just the managers, to buy the company. Schneider agreed to the same price previously negotiated with ABB and to grant more time to put the deal together. Banks, after first balking at the idea of a leveraged employee buyout, agreed to finance about 60% of the acquisition price. For the 40% equity required, 75% was contributed by a group of international investors recruited by Hannart, and the remaining 25% from employees, 80% of whom decided to invest. For protection, employees had a veto right in case of a sale, and the price difference was within a 5% range. They could also keep the shares if they left the company or retired. The deal went through in July 2009.

With 46 staff members investing collectively CHF 1.25 mio in their company, the effect could be felt across the entire staff. Hannart found himself in meetings explaining multiple times the difference between cash flow and profits, the terms of EBITA, the concept of leverage, and many other financial concepts that were new to his mostly technically trained staff.

With newly found independence, Selectron continued to grow. New customers were acquired as a result of its OEM strategy based on B2B marketing and sales relationships. New products were launched, and by 2012, three years after the buyout, sales of the company were approaching CHF 40 mio, 90% generated by train control systems. Growth of 15% annually over this period with sound profitability allowed Selectron to keep R&D at 20% of sales, and sales were expected to continue to grow 10% annually for the next few years. The strong business results allowed the company to quickly pay off the bank loans from the leveraged buyout.

At this stage, Selectron's continued success attracted suitors. One of the companies was ABB who had realized how difficult it was to enter the train control systems business. ABB now offered a price that was 4 times the original offer from 4 years ago. With this offer in hand, Hannart and his team were able to get its lenders to refinance the deal on the basis of the new company valuation. This allowed Selectron to take on sufficient financing to repay some of the original capital such that its employees were refunded their original investment while keeping most shares valued at a now higher price. The value of their shares had soared by a factor of 10. In addition, as some of the international investors were bought out, the employees, with some new ones who joined in, were now controlling 34% of the equity, enough to block any deal they did not like. This position was welcomed by rail customers who could already sense the results from the increased motivation of Selectron staff.

Changing Market Dynamics

By 2015, the advent of Industry 4.0 dynamics changed the competitive forces in the market. The implementation of a new Internet-based communication protocol required the development of cyber security solutions. Furthermore, rail operators were beginning to implement algorithms based on big data solutions.

Equally, the competitive structure was changing. Chinese competitors were entering international markets leveraging huge cost advantages. Increasingly, it became clear that Selectron had a size problem to be considered an equal partner by the Big Three train builders as well as to play separately in markets such as Russia or China where government regulators played an important gatekeeper role. These developments prompted Selectron to look again into forging strategic partnerships, even if it risked independence. In anticipation of such possibilities, Selectron began to develop automation applications for train braking systems, one of the major subsystems for trains and sourced from external suppliers. The idea was to make itself a desirable partner for collaboration.

Slipping Under a Corporate Umbrella Once More

The ink was hardly dry on the last refinancing of the buyout that Knorr Bremse, the leading global independent braking system supplier, came knocking on the door. Knorr was a German company with sales of about Euro 6 billion and a major business in train traction and brakes. Knorr was interested in acquiring Selectron since it was convinced that the train control system, or TCMS, would also become a core technology for managing the various subsystems of trains. Under the simpler mechanical systems, the braking action of trains frequently required refurbishing or replacing the train wheels to keep them round and running smoothly. With electronic braking controls, including antisliding and skipping functions, refurbishings would decrease, hence a technological threat to Knorr's main brake business.

Because of the technological and strategic importance of TCMS, the German company offered that Selectron becomes its own future TCMS developing unit, thus making Selectron central to Knorr's future strategy allowing for the operational autonomy to continue with its chosen direction.

Hannart convinced his team of investors and employees that this was a unique opportunity and that Knorr would be a better owner than Schneider ever was or ABB would have been, and less of a competitive threat to Selectron's existing customer base compared to selling out to a major train builder. As a result, a deal for Knorr to acquire the entire equity of Selectron was concluded at the end of 2014 and implemented in January 2015. Selectron management accepted the goal to grow the company to a sales level of about CHF 80 mio over 5 years.

The deal with Knorr included a 3-year earn-out period that, if successfully delivered, determined as much as 20% of the acquisition price. Hannart and his team were able to convince Knorr to base this acquisition not on a merger basis but on the basis of "concordance," or mutual agreement, of governing issues and with operating autonomy.³⁵

³⁵The term "concordance" was derived from German "Konkordanz" to describe the particular governance system used in Switzerland involving all major parties and striving for consensus rather than being overruled by a dominant party. This model had been adopted in Switzerland by many civic and business organizations as a governance model.

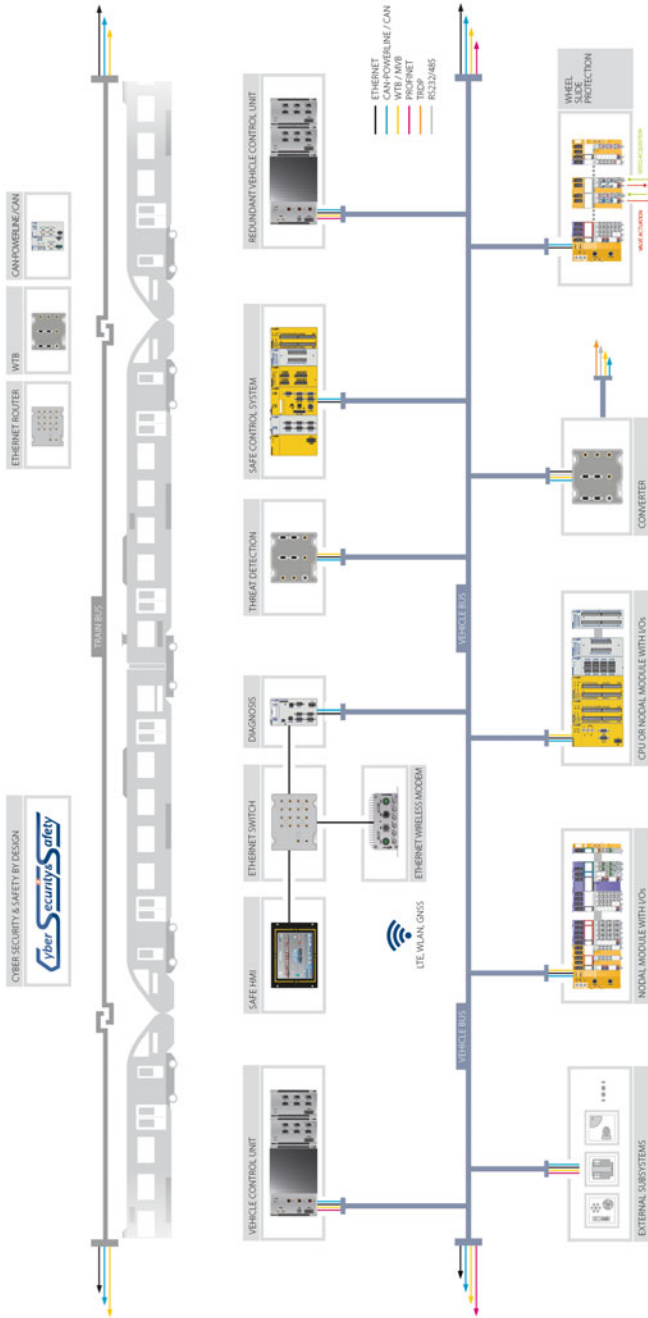

Exhibit 26.20 Selectron systems product line

This led to Knorr basing its new generation of braking system automation on Selectron solutions while other Knorr units involved in other train components, such as doors, continued to develop their own solutions. Selectron was allowed to continue to sell directly to its existing customer base while using Knorr contacts to strengthen its market penetration in countries such as Russia, a market that since has added substantial sales for Selectron.

Under Knorr ownership, Selectron continued to grow around 18% annually. Selectron employment expanded from 120 to 180 staff. Entry into the cyber security market was facilitated, and other sales opportunities with independent brake systems customers in the USA, Japan, and Indonesia were opening up.

Company Profile 23: FISBA³⁶—Manufacturer of Optical Components and Systems. From Endoscope Lenses to Camera Lenses for Lunar Orbiter

Global Leader in Optical Systems and Components

St Gallen-based FISBA, market leader in optical systems and components, served a range of applications, including medical, diode lasers, machine vision, optical communication, and aerospace. The most important use was for medical technology, specifically endoscopy applications, where FISBA had developed leading solutions through its long-time cooperation with the German company KARL STORZ. The company's key competencies included glass molding, optical design, micro-optics, and assembly. FISBA employed 350 staff, 330 of them located in Switzerland. The company marketed its products globally and generated an annual revenue of more than CHF 60 mio with the main markets in life sciences, production technology, and aerospace & defense.

Three Friends Joined to Start a Company

In 1957, Waldemar Striezel was working as optical engineer at Wild Heerbrugg in the nearby Rhine Valley. Wild was a precision engineering and optics company, which later would be acquired by Leica, a large German manufacturer of optical

³⁶This profile was written by Thierry Volery (Professor Zurich University of Applied Sciences and Visiting Professor University of St. Gallen) and Heiko Bergmann (Adjunct Professor of Entrepreneurship University of St. Gallen) on the basis of a company interview as well as publicly available information. Copyright©2019.

microscopes. Striezel wanted to start his own company together with his colleague, Hennoch (Heni) Altherr. His friend Christian Fischbacher (1916–2006), running his own textile business, helped them launch their business under the name of Altherr Striezel. One year later, Christian Fischbacher acquired all shares of the company and renamed it FISBA.

FISBA's first products were optical components, especially customized lenses. There were other companies in the region, including Leica, already active in optical solutions for measurement systems. *Accuracy was the key—in optics you have to be accurate below 1/1000 mm level* (Martin Forrer, FISBA CTO).

FISBA entered the endoscopy market in the mid-1960s as a B2B supplier and quickly established a leading position in this high-growth segment. It soon grew to 30 employees.

Entering Strategic Alliance for Endoscopes with KARL STORZ

In 1965, FISBA initiated a cooperation with KARL STORZ, a large German endoscope producer, for which it exclusively produced micro-optics. Modern endoscopes were expected to provide brilliant images of hidden body cavities. Key parameters to be taken into account were light intensity, depth of focus, magnification, contrast, and resolution. FISBA served as the “extended workbench” and strategic supplier of micro-optic components for KARL STORZ on an exclusive basis until 2016. Focus was on design, which had always been FISBA's strength. The introduction of the rod lens system created the basis for optimal image transmission in endoscopy, allowing a highly realistic image of the surface and structure of internal organs to be produced. This lens system, continuously advanced, still set the global standards.

Other innovative products developed with KARL STORZ included customized high-resolution microcameras with a diameter of less than 2 mm and integrated illumination, a major innovation for endoscopes. *We tried to develop customized designs and then to manufacture the product* (Markus Hersche, CEO). This strategy still held true today, both in medical technology (since 1965) and for optical solutions (since 1985).

As a result of this cooperation, FISBA's business grew at a steady pace, necessitating a move to a new location. In 1976, FISBA acquired a new building in St. Gallen of more than 3000 m². Soon, this building could no longer accommodate the required growth in production. In 1987, FISBA decided to construct a new plant in another location in St Gallen, enlarging its production capacity. In early 1989, the company occupied its new building which came with a total surface of 6150 m². Taking into consideration steadily increasing demands for clean room operations, air-conditioning for manufacturing, and testing rooms, the new premises also provided space for an enlarged R&D staff.

Expanding into Germany and the USA

In 1985, FISBA, trying to lessen its dependency on KARL STORZ by diversifying its business, entered the optical solutions business with a focus on more integrated system solutions, as well as the diode laser and measuring systems markets. Recognizing the importance of Germany's medical technology and photonics industry, FISBA in 1998 opened FISBA Photonics GmbH as its subsidiary in Berlin.

Around the same time, FISBA started to participate in larger space projects, such as the development of a focal reducer and spectrograph for the European Space Observatory.

By 2001, FISBA had grown to 250 employees with sales of CHF 35 mio. Main markets were Switzerland (10%), Europe (80%), and rest of the world (10%). It became apparent that FISBA needed to grow its business in the US market.

However, in 2005, the board concluded that FISBA was too diversified and lacked focus. Hence, the board decided to divest businesses generating less than CHF 10 mio over the next 2–3 years. Only the endoscopy business, as well as optical solutions, fulfilled this requirement. Consequently, in 2008, FISBA spun off its laser soldering and laser plastic welding businesses to Trumpf Laser. The company decided to focus on micro-optics for beam shaping of laser diodes, customer-specific laser modules, as well as the development of OEM assemblies.

In 2014, FISBA expanded its global brand into the USA with the formation of the FISBA LLC in Tucson, Arizona. The project started as a joint venture with Edmund Optics, which was discontinued 2 years later, and the resulting joint venture was taken over by FISBA. Around that time, FISBA became world leader in the Fast Axis Collimation (FAC) lens market with a major global market share.

Winning Accolades for Innovation

FISBA placed considerable focus on technology and R&D, investing annually CHF 3–4 mio into R&D, and maintaining a R&D group of 35, out of 350 employees. Annually, two to five new patents were filed, boosting the overall pool to 25–30 patents.

Testifying to its continuous efforts in innovation, FISBA was awarded several prizes over the years, including the Innovation Prize for Swiss Technology for its diode laser and The Excellence in Value Innovation award for its FAC lenses. FISBA leveraged the award for the FAC lens with its ability to supply JDSU, one of the largest global suppliers of optical communication solutions and laser applications, in volume quantities at short notice and with fast turnaround.

Process innovation also played a major role at FISBA. According to CEO Markus Hersche, systems and microengineering know-how were one of the company's key competences. Furthermore, FISBA cooperated with different players in R&D, such as universities, research institutes, industry associations, and customers. The development of the diode laser was the result of a cooperation with the University of Bern and Bystronic.

FISBA's production expertise, combined with its focus on quality leadership, as well as the focus on exploiting a market niche, led to the company's strong market position, creating entry barriers for any new entrants. For larger players, the market niche was relatively small compared to investments needed to provide high-quality products, and for smaller players, the high costs to enter the market were prohibitive.

Joining European Space Agency Projects

Starting in the late 1980s, FISBA participated in a series of space projects run by the European Space Agency (ESA). The company developed micro-optics for several space missions (Smart 1 Orbiter, Mars Express, Venus Express and JAXA Hayabusa2).

As part of Smart 1 Orbiter program, FISBA cooperated with CSEM, a Swiss research and technology unit, to develop miniature digital microcameras that photographed the moon from every possible angle for 3 years. To meet the constraints and objectives of the mission, this system had to combine miniaturization and performance. For the ESA orbiter "Rosetta" program, which landed on the comet "Churyumov-Gerasimenko" in 2016, FISBA supplied the camera lens.

Although the space business contributed less than 1% of company revenues and generated marginal profits, through these projects FISBA was able to gain new knowledge and to develop technologies which could later be used in commercial applications.

Cocreating with Lead Customers

To be close to the market, FISBA collaborated on an ongoing basis with customers and codeveloped products over long periods. The company historically made a big proportion of its revenues with KARL STORZ, a strategic partner with which it had entered into an exclusive supply agreement.

In its designs, FISBA combined high accuracy with reliability, miniaturization, and other innovative features. Due to its excellent performance and compact design, the company's FAC lenses for laser diodes were state of the art for technical systems in a wide range of applications.

Since optic technologies were deployed in so many different applications, a major challenge was to identify and pursue the most promising segments. FISBA decided to give up activities outside its core business, such as diode laser systems and measurement systems. The company applied a make-or-buy analysis and decided to produce key components in-house only.

Investing in Human Capital and Promoting a Cohesive Culture

Over the years, FISBA recruited and built talent via the apprenticeship scheme, in-house training, and universities and technical colleges, both in Switzerland and neighboring Germany. FISBA invested heavily in the development of apprentices to replenish the pool of skilled employees, with 29 of FISBA's 350 staff being apprentices.

In addition, the company invested in its workforce by encouraging ongoing education and training at technical institutes. The most promising employees could become experts in optics design and photonics. The company highlighted the importance of internal training by cooperating with a large training provider in Switzerland. As a result, staff turnover was low.

The culture at FISBA was described as diverse, inclusive, and collaborative. CEO Hersche observed that the senior management team functioned well and that employees consistently exhibited high levels of engagement working well together. As a result, FISBA could develop efficient organizational routines with little "idle power," according to Hersche. Employees were also running a corporate bowling league, as well as a football club. They often organized events like get-togethers, outings, and barbecues. Former CEO Werner Krüsi highlighted the open communication at FISBA, which positively influenced the motivation of employees, as one of the success factors of the company.

Leveraging Strong Optical Industry Cluster

The company leadership regarded business conditions in Switzerland as very positive, even though red tape had increased over the last decade. High-quality of educational institutions, such as universities of applied sciences (UoAS), and universities, was considered a key factor for FISBA's development.

FISBA benefited from a strong industry cluster in optics and photonics which had emerged after WWII. The pioneers Wild Heerbrugg and Balzers, both located in the Rhine Valley, over time were joined by several other optics manufacturers, including Leica Geosystems, FISBA, SwissOptic, Vectronix (later acquired by Safran), Zünd Precision Optics, and Mikrop, giving rise to a broad, diversified cluster. Technical educational institutions, as well as R&D centers such as Rhysearch and CSEM, contributed to technology transfer and the success of the cluster.

The photonics and optical engineering companies in Switzerland collaborated, sharing market data, industry information, and ideas. Players in the industry established training programs in optics & photonics and were connected through a photonics department at SWISSMEM, the Swiss Association of Mechanical and Electrical Engineering Industries. Additional synergies were exploited by rotating apprentices to provide them with an opportunity to work for different photonics companies during their training period.

Changing Ownership and Governance

Since its foundation in 1957, FISBA had been fully owned by Christian Fischbacher and his family. For more than four decades, the founder was both a central figure and leader in the company. Fischbacher put emphasis on personal presence and discipline, even joining board meetings after incurring a leg injury. He saw himself as team leader and coach. He remained president of the board until his retirement in 2001 at the age of 85.

In 1987, Fischbacher convinced Hans Huber, founder of SFS Group and a well-regarded entrepreneur, to join the board. In 2001, Fischbacher sold 50% of the company to Hans Huber. The proceeds were used to finance further expansion. Following this capital restructuring, FISBA was spun out of the Christian Fischbacher AG holding company, which until then had comprised both textile and optics businesses.

Huber, assuming the board chairmanship from Fischbacher, was a charismatic entrepreneur. He believed in leadership principles, including (1) keeping and supporting Switzerland as attractive business location; (2) treating employees as the most important resources of the company; (3) always working client-oriented; (4) never overestimating your own skills; and (5) to never give up.

Practicing Lean Management

The company had a long tradition of appointing external, professional CEOs to run the business. In 1993, Werner Krüsi was appointed as CEO, a position he held until 2015 when he joined the board of directors and Markus Hersche was appointed CEO. Hersche, an external appointment, was a member of the FISBA board for 5 years and had extensive international management experience in the pharmaceutical packaging industry, having worked for Schott Forma Vitrum, Datwyler Pharma Packaging, and the Stevanato Group.

Since 2016, top management and the board held only a small financial interest in the company. Both the USA and the German subsidiaries were fully owned by FISBA. According to CEO Markus Hersche, FISBA operated with flat hierarchies, kept decision-making processes short, coordination efforts low, and sought to remain agile.

Micro Systems for Imaging Applications

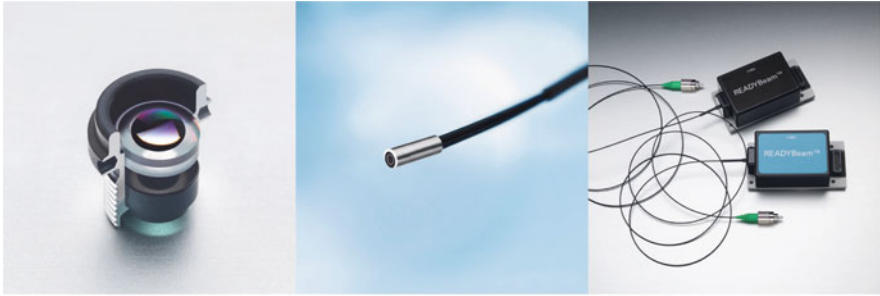

Micro Optics for Laser Diodes

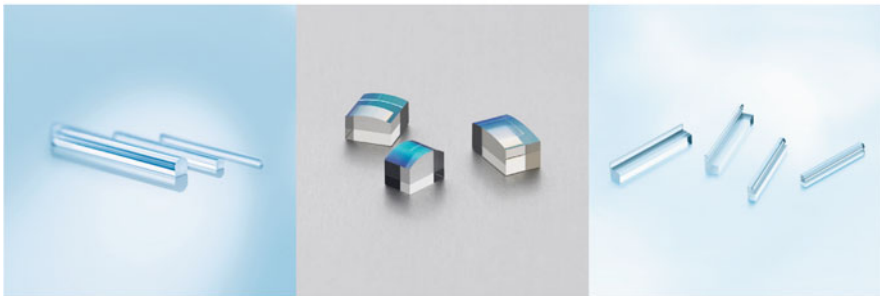

Micro Optics for Imaging Solutions



Exhibit 26.21 FISBA product line

Company Profile 24: Maxon³⁷—Global Leader in Precision DC Motors. High Precision Drives from Medical Applications to Mars Rovers

A World Champion from a Swiss Alpine Village

Visitors to maxon could travel by suburban train from Lucerne to Sachseln, a small town in the Canton of Obwalden (OW). The train ride to Ewil maxon, a dedicated train stop, took just 30 min and left passengers at the edge of the maxon Campus. There, a workforce of about 1300 developed and produced some of the world most exacting electric drives used in applications ranging from robotics to medical applications, passenger aircraft, race cars, and also for NASA's Mars rovers. Started in 1961 by the Braun family to supply components for electric shavers, the family-owned company eventually grew into a global firm with worldwide sales of CHF 526 mio (2018) and a global workforce of about 3000. They produced about five million drives annually in some 12,000 variations.

Starting Out with Electric Shavers in Germany³⁸

The origin of maxon dated back to 1921 when a German engineer, Max Braun (1890–1951), opened a company near Frankfurt that soon was to produce a range of electric apparatus, from radios, shavers, to kitchen equipment. The Braun products were always characterized by high-quality and attractive industrial design. The company grew rapidly but was mostly destroyed in aerial bombing attacks during WWII.

Max Braun rebuilt the company after the war. He died in 1951, aged 61, and left the business to his two sons Erwin (1921–1992) and Artur (1925–2013) who inherited the company and assumed its management. With the company growing rapidly and expanding internationally, the Braun sons found the operating business taxing and withdrew to the supervisory board in the early 1960s.

One of Braun's core products was electric shavers. Key design features were the use of perforated metal foils to cover the cutting blades, allowing facial hair to penetrate through the holes for trimming by the blades. This device feature, combined with significant manufacturing advances of the foil by perforation, allowed for a closer shave than competitive designs.³⁹

³⁷This profile was written by Jean-Pierre Jeannet (Professor Emeritus Babson College [USA] and IMD Institute [Switzerland]) on the basis of a company interview as well as publicly available information. Copyright©2019.

³⁸Braun Family history based upon Anderhalden Andreas (2018) Vom Erdkern zum Mars: Geschichte der maxon motor ag, Sachseln. Brunner Verlag, Kriens.

³⁹Noe R A history of Braun design, Part 1: electric shavers, 3 March 2013. Accessed via website core77.com on May 29, 2019.

Setting Up a Sales Company in Switzerland

In the course of its international expansion, the company established Braun Electric International SA in Baden (Canton Aargau, AG) in the late 1950s and also began to build an international sales organization there. The Swiss Federal Government, which had to grant working and residence permits in ever-growing numbers for the operation, began to put pressure on Braun to build a manufacturing base in Switzerland as well, to avoid losing work permits.

The government also suggested that such a manufacturing operation be built in less developed areas, either the Bernese Oberland, the Grisons, or Obwalden in Central Switzerland. The Braun brothers knew the first two regions from skiing, but not Obwalden, and asked Bodo Fütterer, a Braun development engineer in Frankfurt, to scout out the three and report back. As the story goes, Fütterer encountered poor weather in both the Grisons and Bernese Oberland, but sunny weather in Obwalden along the Lake of Sarnen. The weather and ease of access led to the selection of a site in Sachseln (OW). Land was acquired, and at the end of 1961, Interelectric Sachseln AG was founded.

Supplying Components for Braun

The company commenced production in 1963 with 17 employees. Bodo Fütterer (1927–2018) was appointed head of the operation, but only after Fütterer received assurances that he could report directly to Erwin Braun, then still CEO of the Braun company in Frankfurt, who indicated that he would eventually also take up residency in Obwalden.

The company's first product was a shearing foil for a recently launched electric razor that Fütterer had helped develop while still in Frankfurt. Different from previous Braun razor models, the perforation was accomplished by electrotyping, a chemical process that formed the foil into its intended shape.

Gillette Acquired Braun AG

The Braun company experienced considerable growth with the introduction of its Sixtant razor model. The legal structure of the company in the form of an OHG meant that both Braun brothers were liable with their entire wealth for the company which triggered the conversion into an AG, or limited company, with both brothers owning 50% of the shares. In 1963, Braun AG achieved sales of DM 145 mio and employed 4600 worldwide. The IPO took place in 1964.

With a new minishaver about to be introduced, the Braun brothers did not think the company would be equipped to handle its worldwide introduction despite superior technical features. Gillette of the USA had targeted Braun for some time as an acquisition candidate and acquired Braun in 1967. The sale included the electric shavers and several existing and pending patents, as well as the production

of shearing foils, thus robbing the still fledgling Interelectric in Sachseln of its main revenue source.

Beginning a New Life as OEM Electric Motor Supplier

Parallel to the foil production, Fütterer and his team at Interelectric worked on further developing the small electric motors used in Braun razors stemming from a project undertaken in Frankfurt prior to starting up the Swiss production operation.

Prompted by the massive floods in Hamburg in 1962 that caused a large number of deaths and destroyed the electric power infrastructure, Erwin Braun had asked Fütterer to develop a hand-operated, small appliance that could serve, among other things, as an electric razor. Branded “Autarc,” the device was operated with a hand crank to load a battery and came equipped with a highly efficient electric motor around an ironless rotor. The design of this motor became the blueprint for future small electric motors.

With the loss of its razor shearing blade business, Erwin Braun asked Fütterer to intensify the development of small electric motors that could be the basis for a new business orientation. The sale of the electric shaving foil business to Gillette provided sufficient resources to reorient the company. The development team headed by Fütterer was also benefiting from the talents of Hugo Fritschy (1924–2014), an exceptional design engineer who was to spend his entire career with Interelectric.

Over a 2-year period, the design team developed several small electric DC motors, including a patented process for an ironless rotor which doubled the efficiency and extended the service life of motors based on existing standard technologies. The final step toward mass production came with a new, special rhombic winding technology and the corresponding winding machine which also became a patented process. The motors had diameters from 12 to 32 mm, with the most powerful motor requiring the very small space of 24×34 mm. The product range was branded as “maxon,” a combination of “Max Braun & Söhne.” The new line was launched in 1969, just 2 years after the sale of the shearing foil business to Gillette.⁴⁰

Spinning Off Elfo

In 1975, and as part of an inheritance settlement, Interelectric Sachseln was split into Interelectric for the motor business and Elfo, located nearby, for filters, a business still in existence to this date. Elfo’s products included, among others, filters for Haag

⁴⁰The company adopted maxon as company name in 1999, whereas the holding company name remained Interelectric. For the purpose of this company profile, the name maxon was used for clarity.

Coffee, and retained the galvanic process departments around electroforming technology. Elfo was majority owned by Werner Braun, brother of Karl-Walter Braun, who became majority owner of Interelectric.

Finding a Market for Maxon Motors

The company soon realized that the maxon motors were too expensive for electric razors in comparison to available Asian products. The efficiency of the maxon design favored applications with a battery as the energy provider. Micronel, a Swiss-based start-up in the medical field, needed precision motors and offered a first entry into the medical field. Dictaphones, heavily used in business at that time, required small motors with low noise and constant speed of the tape feature. Olivetti incorporated the small motors into its semiautomatic typewriters. In 1969, the launch year, some 1.5 mio maxon motors were sold.

The building of a professional marketing and sales operation rested on the shoulders of Dr. Karl-Walter Braun (1945), son of Erwin Braun, and an engineer with a talent for marketing in the person of Jürgen Mayer (1939) who was to rise from sales to eventually become CEO of the company when Fütterer retired. Together with Karl-Walter Braun, Mayer attended the Hannover Fair in 1970, the first time Interelectric was present, by renting space from one of its customers.

Breaking into the Japanese Market

At the 1970, Hannover Fair, the Japanese firm Canon made contact with Interelectric which led to a visit by Canon executives to Sachseln. Lengthy negotiations followed, but eventually Canon took out a license for maxon motors which gave Interelectric an early entry into the Japanese market. In 1979, the relationship with Canon resulted in a major order over CHF 8 mio for motors to be used in a tachometer instrument.

The licensing agreement with Canon expired end of 1987 with Interelectric wishing to market its products directly. The agreement had favored large product volumes, whereas Interelectric preferred smaller volumes of specialized motors, combined with a flexibility to react rapidly to changing customer requirements.

Winning a Major Customer in Germany

Interelectric managed to land a major contract in 1978 with Grundig of Germany for the delivery of electric motors to drive recording and video recorders that had just entered the market. This represented one of the largest orders the company had ever received and the ramp-up to deliver meant that sales to Grundig soon represented 80% of company sales. To manage the volume growth, the company had to rent adjacent buildings, there was not sufficient time to expand buildings on its own.

Within 2 years, however, Grundig, and also Philips, lost to Japanese competition and the market for maxon motors declined correspondingly. Although the large Canon order helped cushion the sales decline to Grundig, only the constant innovation for new and more efficient motors kept the business going.

Creating a Modular Product Line

Ever since the introduction of the first maxon motors, Interelectric consistently introduced new product families with ever better and ever more efficient motors. Many of the inventions were first showcased at major industrial fairs, such as the Hannover Fair.

The company built an extensive, modular product line where products could be configured from a website using available components. Actual configurations ranged from 12,000 to 15,000 variants, but theoretical combinations were *in the billions*.

maxon product line covered motors which typically consisted of 30–70 components. Gears added another 20–50 components. Then, there were controllers, and sensors of several different technologies. Accessories and ceramic components were also part of the maxon product line. All items were accessible to engineering designers through an online system allowing custom-specific configurations.

The main elements of maxon's product line were its brushless and brushed DC motors, as well as its mechatronic drive systems. Brushless DC motors offered excellent characteristics with respect to torque, power, speed range, and a long life span. Some of the motors were exceptionally economical and others flat, depending on the required engineering solution.

The maxon brushed motors came equipped with powerful permanent magnets and the patented ironless rotor, offering compact, powerful drives with low inertia. Low inertia resulted in high acceleration. The modularity of the range offered countless options for top performance at a competitive price.

Finally, the maxon mechatronic drive systems product line was built around the fact that such systems worked only if all components were perfectly synchronized. Maxon was able to combine the various elements by integrating them into a mechatronic system which resulted in a compact design and component configurations according to the customer's application.

Evolving the Segmentation Strategy

maxon motors found their way into many application areas. Originally starting with motors for consumer applications, the segment composition was constantly changing and evolving, requiring adaptations and innovation on the part of the company.

When the company began to grow (it had reached CHF 50 mio in sales in 1990), the majority segment was industrial robotics with up to 50% of sales, which by 2018 declined to about 20%. The segment then became robotics and automation, including transportation. Taking its place as segment leader in turn was medical with as

much as 50% of sales. Aerospace was also shifting from pneumatic driven to electronic-driven, expanding sales opportunities. The transportation segment moved from functional mobility to system partners, as in the case of the e-bike system where maxon became industrial partner for its maxon BIKEDRIVE, consisting of rear motor, battery, and controller.

Exploring Space with maxon

When the US space agency NASA inquired in the early 1990s about maxon motors that could withstand very low temperatures, few could imagine that this would lead to a business relationship that would literally put maxon on the world map and on Mars. It took several years, and visits to Sachseln, until the project was completed, and NASA's "Sojourner" mobile rover landed on Mars in July 1997, powered by 11 maxon motors. With the nomination of Interelectric as preferred supplier, the company gained worldwide notoriety and fame regarding the reliability and quality of its drives.

In 2004, NASA landed two more rovers on Mars, "Spirit" and "Opportunity," each equipped with 39 maxon motors. maxon motors were also in the Cassini satellite exploring Saturn, and new projects with NASA were planned. maxon also collaborated successfully with other space agencies.

In line with the constantly growing number of applications and segments, the company was reorganized along new business units: medical, aerospace, industrial automation, transportation, and e-mobility and robotic solutions. More emphasis was to be put on motion control systems for inclusion in human-type robot systems, and robots for use in agriculture. To drive innovation, maxon employed about 200 specialists, mostly in Switzerland, some in Germany, and spent about 8% of sales on the effort.

Internationalizing the maxon Manufacturing Footprint to Germany

The Sachseln operation in Switzerland remained maxon's largest production and development base employing about half of its global workforce. The Swiss operation engaged in all manufacturing activities, including assembly, for which the company also employed some homeworkers in the region, mostly women who tended to have higher manual dexterity. The Swiss operation also tested assembly and production lines before they were added to overseas plants. As Eugen Elmiger, CEO, pointed out, *maxon does not transfer production, we duplicate it elsewhere.*

The winding process was a core aspect of production. Winding machines were developed and made in Sachseln with a team of dedicated production engineers. The process was patented, and the equipment, not available on the open market, was constantly modified and improved, reaching Industry 4.0 standard. The winding time

of rotors was steadily improved from initially 10 min down to 5, later to 1 min, and finally the latest generation of equipment moved it into the 12 s range.

As the Interelectric head count at Sachseln grew, so did the difficulty of hiring staff. The Canton of Obwalden offered only a small labor pool and a lack of expansion capability risked having to extend delivery times and losing flexibility. In response, Interelectric decided to open a manufacturing plant in Sexau, near Freiburg in Germany, concentrating on gears. They were first developed and designed in Switzerland and then transferred for production to Sexau. With expanding volume, the business unit for mechatronics and dental applications were also concentrated in Sexau. *The mentality in the Schwarzwald region of Southern Germany is similar to Switzerland, making collaboration and integration of operations easier* (Eugen Elmiger, CEO).

Expanding Production into Hungary

The constant cost pressure caused by revaluation trends of the Swiss Franc eventually forced Interelectric management to look for a lower-wage production base. The company eventually focused on Eastern Europe and Hungary in particular. Wage costs in Hungary were about one-fifth of Switzerland's, at the same time offering a sizeable, sufficiently trained labor pool. Starting in 2001 with just a small team, the operation was expanded in several steps to reach a labor force of several hundred. The Hungarian plant engaged in production and assembly. The winding technology in place was not the latest, with winding times more in the range of 30s per unit. This level of technology, however, was at risk to be copied in China.

Expansion into Korea

Increased business in Korea led to the creation of a production unit there as well. Growing out of a successful distribution business, the Korean operation began with the production of brushless motors with iron-core winding, because winding around iron was easier to accomplish. A robotics operation for iron cores was added later, in 2013. Labor costs in Korea were about one-quarter of the Swiss level.

Despite the high wage level, the Swiss operation was still competitive on the basis of profit per person, the key operating metric used at maxon. The indirect costs at the Swiss operation were about two-thirds, with one-third for direct production. However, a shift was taking shape there as well. Smaller production operations were maintained in France and the Netherlands.

Globalizing Sourcing

Sourcing components and materials was a global process at maxon. Still, about 60–65% originated in the DACH region (Germany, Austria, Switzerland). Other

purchases were made in China, Sri Lanka, and the South East Asia region. The Korean factory operated largely on a localized basis.

Building a Global Marketing Footprint

From the very beginning, Interelectric was an export-driven operation. As early as 1981, exports amounted to about 85% of sales, half of which to Germany. Not surprisingly, the company opened its first fully owned sales subsidiary in Germany in 1979 when servicing the German customer base from Switzerland only became increasingly difficult. Two years later, the company started its own US sales company in California, ending the arrangement with an independent distributor. There followed a number of own sales subsidiaries and branches in Asia.

At this time, maxon was marketed or represented in 40 countries with the majority of these operations company-owned. Sales agents were still maintained in about 10 smaller markets, including Thailand, Brazil, Israel, and Canada.

Competing on a Niche Basis

Maxon was a major player in the global market for small electric motors and drives, but not the largest one. Maxon focused on high-end niches where precision in movements was of great importance. This included niches such as medical, where reliability and movement precision were of great concern. In addition, maxon was careful to inquire about a prospective client's expectations regarding delivery time and price, two critical conditions.

Other players in the space included Nidec Motors, a US-based company with 140,000 employees and a broader product line. A second competitor was Faulhaber, a German company active in about 30 countries and 1900 staff. Its product line was similar to maxon. Finally, there was a third international player, Portescap, which originally was started in Switzerland and had a strong presence in the watch industry. Portescap had estimated sales of about USD 100 mio and 1000 employees. The company was acquired by Fortive, a large US-based company with sales of USD 7.2 billion and 24,000 employees.

Fighting the Battle for Talent

As an operation based in Sachseln in Central Switzerland, attracting the right and sufficient talent was a major concern. Therefore, the company engaged in an extensive apprenticeship program with about 50 apprentices enrolled at any time. The company was considering expanding to about 100 apprentices, if possible, drawing from a wider geographic range which would mean building a residence, similar to university dormitories, for apprentices to stay at during the week. As part

of an upgrade of its existing workforce, maxon began to enroll some of its female assembly workforce in a formal apprenticeship program in mechatronics.

Development and research talent were recruited from the leading Swiss engineering schools. Eugen Elmiger, CEO of maxon, and close to 30 years with the company, experienced himself the power of the apprenticeship system that provided skills which university-educated engineers could not easily come by.

Relying on Professional Management

Management of maxon was in the hands of professional managers with long experience at the company, in the industry, and with deep roots in the relevant technology. With the exception of Karl-Walter Braun, the company's main shareholder, ownership did not get involved in operative management other than remaining close to technology. In its more than 50-year history, the company only had three CEOs who also served as board chairmen for much of their tenure.

Bodo Fütterer, who drove much of the early history and development, served as CEO from 1963 to 1992, and as Chairman of the Board from 1973 to 2004. He was succeeded by Jürgen Mayer who had joined the company in 1967, serving as CEO from 1992 to 2006. After Fütterer retired from the board, Mayer also served as board chair from 2004 to 2011. Eugen Elmiger, who had joined the company in 1991, became the company's third CEO in 2011.

Commenting on the management style and culture of the company: *maxon is interested in finance as it is fully self-financed, but the company is technology driven at heart.* (Elmiger, CEO).

Governance and Ownership

From the outset, ownership of Interelectric and maxon were in the hands of the Braun family. After settling inheritance issues, and following the spin-off of Elfo in 1975, Karl-Walter Braun became majority shareholder of maxon in 1975 until today. Some shares were held by former CEO Mayer and also Karl-Walter Braun's daughters Bianca Braun (1978) and Tanja Braun (1986). Although a number of Braun family members became involved over time, there was always one main decision maker in the person of Karl-Walter Braun. The company was determined to remain private and family-owned and had no intentions to go public.

The principal owner representative, Karl-Walter Braun, was partially raised in Switzerland after his family moved there in 1960 and became a Swiss citizen in 1982. He served in the Swiss military and was training as a microelectric technician following his initial commercial education. He entered the company in 1975 and worked for many years in several CFO and controller roles aside from serving on the board of directors. Even though he was the main shareholder of the firm, he served as Vice Chairman of the board during the years when Fütterer and Mayer held the board

chairs. Today, Braun served as the Chairman of both the holding and the operating company.

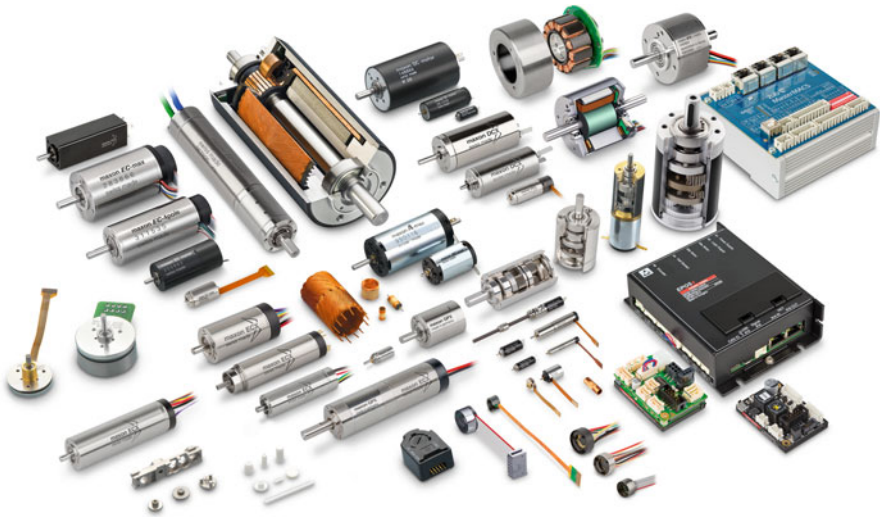

Exhibit 26.22 Maxon product line

Company Profile 25: Sylvac SA:⁴¹ The Measuring Experts. Digital Measuring Instruments and Systems for Industrial Use

Sylvac Combining Micromechanic with Microelectronic Skills

The Sylvac company produced hand-held measuring devices and instruments, such as calipers, that had traditionally been used in industrial production processes all over the world. With sales of about CHF 30 mio, the company achieved global distribution and a reputation for the highest quality measuring devices in the 1/1000 m range. For measurements to be taken in exacting industrial machining processes, such as measuring the diameter of a machined part, customers wanted to be assured of high precision. In addition, Sylvac managed to add electronic components to a mechanical measurement process, or to hand tools, that read results digitally. This marriage of precision micromechanics with microelectronics was driven by the entrepreneurial engagement and cooperation of two families, now in the third generation of ownership. Sylvac employed about 130 in two locations in

⁴¹This case was written by Jean-Pierre Jeannot (Professor Emeritus Babson College [USA] and IMD Institute [Switzerland]) on the basis of company interviews and publicly available information. Copyright ©2019.

Switzerland, in Malleray (Canton Berne) and Crissier near Lausanne, and about 30 employees in China.

Two Families Start to Enterprise Together

Sylvac's history was intrinsically intertwined with the personal histories of two families, the Meyer family based in the Lausanne area, and the Schnyder family based in Malleray in the Jura (BE). The relationship was based on family bonds through marriage. The elder Meyer and Schnyder had met during their apprenticeships and marriage created the family bonds. The creation of Sylvac, however, was to take a few turns over time until the company, in its present form, emerged.

The Entrepreneurial Background of the Meyer Family

Hans Meyer (1914–2010) completed his apprenticeship with the machine builder Oerlikon (MFO) followed by a degree from the Engineering School in Burgdorf in electronic engineering. Following a stint with Autophon, he joined Lausanne-based Tesa, originally a company associated with Autophon, but later it became an independent business in the field of measuring devices. At Tesa, Hans Meyer developed micrometers. He was still at Tesa when the US firm Brown & Sharpe acquired the company in 1967. He then became an independent consultant, working for Tesa, licensing his inventions.

When Meyer's son Hans-Ulrich completed his mechanical engineering degree at EPF-L in Lausanne, he followed up with a degree in electronic engineering at Rensselaer Polytech in the USA and work experience at Brown & Sharpe in Rhode Island, USA, the new owners of Tesa. The young Swiss engineer soon found out that modern electronic ideas were not welcome at this traditional US company and returned to Lausanne.

Hans Meyer left Tesa, and in 1972, together with some former Tesa colleagues, he started Trimos, a new company to produce a line of competitive measurement devices.

He had also started an engineering office in 1973 under the name of Sylvac where his son Hans-Ulrich developed electronic height measuring gauges. This operation was finally incorporated to form Sylvac SA in 1978 with Meyer father and son, plus some former Tesa managers, as shareholders. The main business of Sylvac consisted of selling electronic control units for measuring devices to Trimos, the company founded in 1972 and partially owned by the Meyers. The name of Sylvac was said to have been invented by Meyer, Jr.

It was during this time that the entrepreneurial fortunes of the Meyer and Schnyder families became intertwined.

The Entrepreneurial Background of the Schnyder Family

Urs Schnyder (1944–2013) was the son of an old friend and former colleague of Hans Meyer. Meyer, also the godfather of Urs, had married Urs Schnyder's aunt. When Urs Schnyder lost his mother at a young age, it was only natural that he would spend a lot of time with his aunt and the Meyer family.

Urs, who continued to grow up in Malleray in the Jura, was the quintessential mechanic who already as a teenager had his own machine tool in the basement of the family home and, at the age of 15, was engaged in subcontracting work for the watch industry. Following the completion of his apprenticeship as a polymechanic, he became a subcontractor for Tesa, with his own small mechanical shop. In 1969, Urs Schnyder formed his own company, Schnyder & Cie, in Malleray, and became the supplier of delicate mechanical scales for the companies Tesa, Trimos, and Sylvac, since electronic measuring devices needed accurate scales.

As the business grew, the mechanical parts supplier Schnyder Cie had up to 85% of sales connected with Sylvac SA where electronic measurement devices were mounted to the subassemblies delivered. The two companies developed in lockstep together.

Converting the Sylvac Product Line to Digital

From the outset, the Sylvac operation run by the Meyer family in Crissier, near Lausanne, had focused on digital components sold to nearby Tesa, and Trimos. When Hans-Ulrich Meyer returned from the USA, fresh from his electronic engineering university degree, he immediately joined what was then still a engineering design office and went about designing a proprietary chip that could convert readings of calipers into digital output.

In 1980, the first digital calipers were introduced. The chips for the digital units were sourced from Heuer, a Biel/Bienne-based watch company and adapted by Hans-Ulrich Meyer. Sylvac could buy up to 10,000 chips and use them in its measuring devices under its own name.

In 1983, Sylvac was forced to switch to sourcing chips from Marin, a unit of the Swatch Group. The challenge was a 100,000 minimal annual purchase requirement, far exceeding Sylvac's own unit sales. To make up for the lack of own sales, Sylvac found customers in Germany and Japan for about 75% of the required volume. This turned Sylvac into an OEM supplier, also manufacturing calipers for non-Sylvac brands. Sales to the USA were not possible because Marin in turn was under US license.

Hans-Ulrich Meyer developed several generations of chip designs reaching an accuracy of 1/1000 mm by 1988. These chips were manufactured by Marin with the IP exclusively owned by Sylvac. Marin was not allowed to sell these chips to other clients. For each generation of chips, Sylvac paid for the necessary tooling at Marin, amounting to about CHF 500,000 for each new generation of chips. Eventually, the required purchase volumes rose to 250,000 annually on firm transfer prices

negotiated. Still, only half of the output was absorbed by Sylvac branded products and the other half by its OEM deals and business.

A Far-Reaching Merger of Two Family Businesses in 2006

The close collaboration of Sylvac SA as development and sales arm, and Schnyder & Cie as the manufacturing arm, continued for about 25 years to their mutual benefit. Sales increased steadily, from about CHF 2 mio in 1989 to CHF 20 mio in 1998. It weathered changes in management, when the two sons of Urs Schnyder, Eric and Jacques, joined the business, and at Sylvac, management was in the hands of Daniel Liechti, son-in-law of Hans Meyer, the company founder, and brother-in-law of Hans-Ulrich Meyer. The founders of the companies wanted to make sure that the future was in the hands of their second and third generations and thus decided to merge both companies into a single entity under the Sylvac name.

At the time of the merger of the two firms in 2006, employment at Sylvac in Crissier, Lausanne, had reached 40 persons, and 46 were employed at Schnyder with operations in the two neighboring Jura towns Malleray and Bevilard. Another 10 persons worked in the Shanghai operation.

The founders ensured that the transfer of ownership could take place at reasonable share prices such that the Schnyder family, with Eric and Jacques, was able to acquire a majority of shares, with the remainder of the capital in the hands of the Meyer and Liechti families. The Schnyder brothers had undergone apprenticeships as polymechnics, and the older, Eric, also graduated from the engineering program of ETS in St-Imier, followed by a management program. Jean-Noël Liechti, son of former CEO Daniel Liechti, joined the company to head the IT department. Eric Schnyder assumed the role of CEO and his brother Jacques Schnyder headed manufacturing at Malleray.

The merger allowed for a number of administrative functions, such as IT and HR, to be consolidated across the two operations that remained at their locations, about 1 h drive apart.

With the next generations in charge of management and ownership, important investments into plant and real estate could be undertaken. A completely new and modern factory was built in Malleray, financed partly by sale of previous real estate no longer used and a capital injection from the Schnyder family. Half of the CHF 12 mio investment came from mortgage lending.

A similar project was underway with the sale of the old Sylvac real estate in Crissier, Lausanne, and moving into a new and modern structure in the Yverdon area, which would reduce the driving distance between the two operations. A single location for both operations was not realistic since many employees in Malleray, the site of the old Schnyder factory, went home for lunch and would not want to move to Yverdon. Likewise, many of the Crissier/Lausanne employees who tended to come from the greater Lausanne and Yverdon area would not be willing to relocate to Malleray in the Jura. Each site, however, maintained its original orientation and mandate in manufacturing and development.

Expanding the Sylvac Product Line

Originally starting out with handheld tools for measuring, the company had steadily innovated beyond calipers. Digital indicators were added, and the product line included micrometers, internal measurement instruments, measuring benches, and height gauges.

More recently, Sylvac pioneered the area of connected metrology by offering Bluetooth connections for its tools. Scanners for optical measurement, ranging from vertical to horizontal and equipped with zooming, were a first step into the instrument or equipment segment with considerably higher price points. Sylvac developed its own software and electronics to go with all of its tools and instruments.

The Sylvac Manufacturing Footprint

The Sylvac history of two family businesses coming together with each having its own manufacturing operations meant that this dual model was retained. The Malleray site in the Jura focused on handheld measurement tools. Given that the company worked in small batches of lot sizes of 20 units, the introduction of pick and assembly robots was intended to allow for output growth at stable staffing levels. Large assembly stations allowed for flexibility.

The Crissier site eventually moved to Yverdon and retained its focus on electronics and software development and the assembly of the larger scanning units. Once a new operation was started in Yverdon, the layout was expected to be similar to the Malleray site. Colocation of manufacturing and development were considered important for both operations.

The China operation near Shanghai had a dual role. The first was to help in the sourcing of components to be sent to Switzerland. The second was as an assembly point for those tools traded through OEM arrangements in the Asian region.

All products sold under the Sylvac brand name were assembled in Switzerland, and the company had no plans to produce in China beyond its OEM business, which was not sold under the Sylvac brand.

Concerning the caliper product line, the company sourced blank calipers and finished them. Given that the new rules for the label *Swiss Made* required that 60% of the value added, exclusive of R&D input (S/W), originated from Switzerland, Sylvac had to change its documentation for that product line. According to management, the Swiss flag had to be eliminated from all catalogs. Since the company image remained Swiss, this was not viewed as a big marketing problem.

Evolving Business and Sales Model

Sylvac and Schnyder companies from their beginnings worked primarily as OEM suppliers to Trimos and Tesa. The development of digital measurement devices marketed under the Sylvac brand shifted the business to direct sales through an agent

network. The next shift came when the company pushed OEM sales to make up for the increased minimum purchasing requirements for chips. Sales under the Sylvac brand name and OEM business accounted for roughly half of company sales each. Measured in sales value, the OEM business had actually declined to mere 20% due to lower unit prices for those products.

For distribution, Sylvac relied on an extensive global network of independent agents covering most markets with substantial manufacturing industry clusters. A team of half a dozen technical sales representatives maintained the connections with agents. In two European markets, France and Germany, Sylvac collaborated with Trimos SA and owned part of the distribution operations. The China operation and OEM sales from there were fully owned by Sylvac.

The vast majority of Sylvac sales were exports. European markets accounted for about half of sales, the USA for about 15% and Asia-Pacific for about 20%, and 15% went into many other smaller markets.

Making an Acquisition for Expansion

Aside from buying parts of European distributors in France and Germany, Sylvac was able to land a strategic acquisition of an entire product line from Tesa, then the larger company and part of Hexagon of Sweden, and located near its Crissier operation. When Tesa evaluated several of its product lines, Sylvac was able to acquire the optical scanning business from Tesa including 11 employees, in sales and engineering, and the corresponding equipment. This acquisition enabled Sylvac to develop its entrance into the optical scanning segment and expand beyond handheld measuring tools into equipment.

Managing Turbulence

Although sales for Sylvac progressed steadily to reach almost CHF 30 mio, the company did experience several serious downturns caused by external economic circumstances. In all of these situations, financing through its banks was an issue. The first downturn occurred in 1990 when sales to its US distributors suddenly dried up as a result of banks having made unilateral changes in financing customer terms without informing Sylvac beforehand.

More significant was the impact of a downturn of about 1/3 in sales in 2002 with the main lender for Sylvac suddenly deciding to remove from its loan portfolio measurement companies, such as Sylvac, but also Trimos and Tesa. Fortunately, a regional bank stepped in to help out when Sylvac loans suddenly came due.

The financial crisis of 2008/2009 resulted in another major sales decline when the company lost half of its sales. Although the market came back within a year, it did show that Sylvac sales were closely tied to overall GNP growth fluctuations and, in particular, to changes in machine tool sales.

Maintaining Competitiveness

As a relatively small player in the field of metrology, Sylvac benefited from its singular focus on measurement tools and devices. Spending about 12% annually on R&D activities, Sylvac leveraged its measurement accuracy and IoT connectivity. Reliability in the eyes of the end user was critical. Users had to rely on the results of their measurements, which required trust. Those elements were the leverage points for Sylvac against its largely Chinese and Japanese competition.

A contributing factor was its skilled workforce. In Malleray, the company offered several apprenticeships in collaboration with other local firms. Electronic and software developers were often recruited from the technical programs at HES in Yverdon.

In recognition of its achievements, the Swiss Venture Club (SVC) selected Sylvac in 2016 as the best SME in the French-speaking part of Switzerland.

Ownership and Governance at Sylvac

Since the merger of Schnyder & Cie and Sylvac S.A. into a single company under the name of Sylvac SA, no major changes in ownership have occurred. The Schnyder and Meyer families managed to find a solution to engage the third generation of leaders in the combined firm allowing the brothers Eric and Jacques Schnyder to acquire the majority of the shares and Eric Schnyder to become CEO of the operation. Together, the two families had navigated through several ups and downs to constantly evolve the firm's technology platform and expand sales from hand tools into the instruments and equipment sector.



Exhibit 26.23 Sylvac product line

Company Profile 26: Bachem Group⁴²—Global Leaders in Peptides. Simplifying the Job of Life Science and Pharmaceutical Researchers

Building the Global Leader in Peptide Chemistry in a Small Town Outside Basel

Located in the small town of Bubendorf in the countryside outside Basel (Canton of Basel Landschaft, BL), Bachem Group was known as the “Pioneering Partner for Peptides” used in the pharmaceutical and life science industry. Founded in 1971 by Peter Grogg who had apprenticed as a laboratory technician in the pharma industry, the company grew to a global sales volume of CHF 282 mio (2018) employing some 1100 at its main operation in Bubendorf as well as at international subsidiaries. The company pioneered and created the merchant market for synthetic peptides, achieving global market leadership in its chosen segment.

Peptides were critical chemical building blocks used either in the life science research process or in the development of a particular pharmaceutical product, especially in the early phase research projects.

Peptides are long chains of amino acid with sometimes up to 80 elements and are essential building blocks of life. As substances in our human bodies, they control bodily functions such as sleep, digestion, as well as immune defenses, growth, and pain. Peptide chemistry is all about life science. The human body produces huge amounts of peptides. At Bachem we create them synthetically (Peter Grogg, Interview, Handelszeitung, October 14, 1998).

Leveraging Apprenticeship into Business Opportunity

Bachem founder Peter Grogg (born 1942) grew up as the youngest of seven children. His father was constantly reminding him and his siblings that *what you cannot do yet you can always learn, and what others can, you can, too*. He took on an apprenticeship as a chemical laboratory technician with Ciba, a Basel pharma company that was merged into Ciba-Geigy, and later into Novartis. In 1964, 2 years after completion of the apprenticeship, Grogg decided to enroll in a part-time continuing education program. There he connected with Robert Schwyzer, head of the peptide research program at Ciba. When Schwyzer moved to Washington University in Seattle for a sabbatical, he took Grogg along. This project involved research into peptides which up to that time were produced in-house by each pharma company according to their special needs. Grogg learned to make peptides for research purposes.

⁴²This case was prepared by Jean-Pierre Jeannet (Professor Emeritus of Babson College [USA] and IMD Institute [Switzerland]) on the basis of a company interview as well as publicly available information. Copyright©2019.

Schwyzler returned to Ciba after 1 year, leaving Grogg behind who liked his experience in the USA. He assumed the leadership of the peptide group of Cyclo Chemical Corporation in 1966. Just 1 year later, he became partner in Fox Chemical Corporation. During his US stay, Grogg became acquainted with corporate finance and began early to invest his savings in the stock market. He remained in the USA (California) until 1971. When returning to Switzerland, he brought along his administrative and finance experience acquired during his 7-year stint in the USA, as well as some accumulated savings in the form of shares in public companies.

Unanswered Job Application Lead to a Business Start-Up

Upon his return to Switzerland in 1971, Grogg immediately applied for a job at Ciba, his previous employer. However, the company did not even bother to respond to his CV and job application letter. Undeterred, Grogg knew that at pharma companies, research teams produced their own peptides based on amino acid derivatives, a process he was familiar with from his US experience. Without a job offer, Grogg offered researchers he knew at Ciba to produce peptide synthesis needed for research projects, thus taking away their “pain” by freeing them from a time-consuming job and allowing them to focus on their research work.

The value proposition from Grogg resonated with pharmaceutical researchers. In 1971, with an investment of CHF 50,000 and his wife as partner, he set up his own operation with two employees in rented premises in Liestal. The new company, Bachem⁴³ Feinchemikalien AG, focused initially on peptide synthesis. To start his business, and to save on needed capital, Grogg made adjustments in a number of areas. For his laboratory equipment he used elements of a simple standard home kitchen, and his friends at Ciba let him buy a used car cheaply, filled with empty discarded vials.

In parallel, a second company was started in Torrance (CA) in the Los Angeles area. This operation was run and co-owned by Grogg’s partner using the name Bachem Inc. Due to financial disagreements, the partners went their own ways, and the operation continued separately, turning into a competitor. In addition, customers became confused between the Swiss and the US operation, which led Bachem Switzerland to acquire its US competitor in 1996.

Scaling the Business Step-by-Step

Sales of the young company grew from the start so that in 1977 Bachem had to move to expanded quarters, selecting to rent space in Bubendorf. The move took place with eight employees. Bachem focused on the building blocks used for producing peptides by applying new technology and eventually automated processes. Peptides

⁴³The company name “Bachem” was a short version of “Basel Chemicals.”

for use in medicine under GMP guidelines were introduced in 1978. Over the next 10 years, Bachem tripled its production capacity, added an administration building, and grew the number of its staff to 150.

With Bachem profitable from its first day, the young company could expand based on its own internal resources. Its first owned plant location in Bubendorf came at the suggestion of its bankers whom Grogg asked to look out for a used factory that he could retrofit for peptide production. The Bubendorf opportunity arose because a local galvanizing company had gone bankrupt and the company's operations were on a site that included considerable additional land for future expansion and could be acquired at an advantageous price.

To make his first factory acquisition in 1997, Grogg took out a mortgage for just 5 years and financed the interest by subletting part of the space he did not need. To finance the building of a second factory in 1981, Grogg took out a credit of CHF 10 mio. This was the last debt financing needed for some time as further investments were realized without recourse to external sources.

The expansion of Bachem happened step by step. Grogg moved fast, but not too fast to avoid outstripping his own resources. Although at first skeptical if this business had any potential, Grogg soon realized that this could become a sizable company. By 1998, the company head count had expanded to 331 and sales reached CHF 96 mio, in part due to the acquisition and integration of Bachem Inc. in the USA.

Learning to Focus on Key Industry Segments

The market for peptides was divided into two major users as well as two technology segments. Technologically, Bachem stayed in the synthetic peptide area in contrast to recombinant or biologically based peptides. The two areas had significantly different manufacturing processes, with biologically derived peptides dominated by companies such as Novo of Denmark. At one time, Bachem tried to enter this sector but failed and was now limiting itself to synthetic peptides. The same limitations also applied to the entry into the synthetic field by other companies, such as Lonza who unsuccessfully tried to enter the synthetic sector. The result was that there were essentially two classes of competitors who did not directly compete with each other.

On the user segment side, Bachem competed in both the research segment and the GMP segment (for use in pharmaceuticals). For the research segment, which was Bachem's original market entry, no GMP specifications were required as these products did not enter humans. This was a catalog business based on basic building blocks. Sometimes, the peptides ordered for research could also be client-specific. About 10% of Bachem sales were to this segment. Main customers were university and pharmaceutical research departments. Business was conducted through a catalog, and the size of the product line topped 6500.

The GMP segment, or pharmaceutical products segment, was the larger segment and accounted for about 90% of Bachem sales. These peptides ended up in

medications used in humans. Their use could be in clinical studies, either for phase I, II, or III. Once specified for a trial, sales are stable. The product was owned by the pharma client and typically was custom-made. Sales were made under supply agreements, a forecast made by the purchasing customer, and included supply chain management commitments. Growth in this sector was directly dependent on pharmaceutical and biotech companies research activities and clinical trials for new products.

Expanding Globally Through M&A

Throughout its expansion, Bachem made several acquisitions that added to its global footprint. Most of the acquisitions came from companies that had approached Bachem and had offered themselves for sale, reflecting more of an opportunity-driven rather than a planned approach. Each piece of the puzzle was then integrated into the overall Bachem operations.

The first major acquisition came in 1996 when Bachem AG was able to acquire Bachem, Inc. located in Torrance, California. Originally established by Grogg with a partner in 1971, the two separated over a business disagreement within 1 year, turning the US company into Bachem AG's major global competitor. When the original partner wanted to sell, Bachem used the opportunity to acquire the entire operation in 1996 and integrate it into its own business, thus creating Bachem Americas, Inc. With this acquisition came also subsidiaries in Germany and in the UK.

In 1999, after lack of success, Peninsula Laboratories, also located in California, were prepared to sell and approached Bachem. The company marketed different peptides, largely focused on immunology applications, which represented a new field for Bachem, confirming the fact that *once you leave your core you are facing different competition*. Included in this acquisition was a subsidiary in the UK which was later integrated with the earlier operation acquired along with Bachem Inc. into a single Bachem (UK) Ltd. in St. Helens.

The acquisition of Sochinaz in 2001, a Valais-based company offered to Grogg, brought different chemistry skills to Bachem. Sochinaz was into earlier building blocks and basic chemistry which, following integration into Bachem, allowed the combined operation to reduce its external purchases as it represented a backwards integration for Bachem. The three major acquisitions had not only expanded Bachem's market reach and production footprint, but also enlarged its head count to 500.

The acquisition of the Clinalfa brand business owned by Merck Darmstadt and located in Läuvelingen (BL) brought to Bachem the Clinalfa brand, as well as the existing customer base, and the technical team. The unit extended Bachem's reach into biotech in the form of a forward integration where large pharma companies usually did this work in-house and expanded the product range into liquids, now just powder.

An additional opportunity arose in 2015 for Bachem to acquire American Peptide Company located in Vista, California. The Japanese pharmaceutical company who owned the operation was known to Thomas Früh, Bachem CEO, facilitating the acquisition. Strategically, Bachem gained additional manufacturing capacity during a phase of strong growth. It became Bachem's second major manufacturing site in the USA.

Creating a New Business Model for the Industry

Ever since its founding in 1971, Bachem had taken the lead in creating a business model that was new in the life science industry. Had up to that time peptides been produced internally by each company, Bachem created the market for a merchant supplier doing business with multiple life science customers. Over time, the peptide supply moved from being almost entirely captive to about 70% merchant based, a major change for the industry.

Bachem articulated its approach as the 360-degree business model by surrounding the entire life science product and research process with products and services at all steps, ranging from initial research to include preclinical development, clinical development, and the supply of peptide drugs up to commercial scale introduction.

To the research community, Bachem offered its 6500 products, all made in-house, available from stock and to be ordered through a webshop. It represented the largest such product line in the industry. To the preclinical development teams of biotech and pharmaceutical companies, Bachem was able to offer custom-made peptides for the extensive panels needed in the process of further refining target compounds, involving close partnering with life science companies. During clinical development, when the target compound had been identified, Bachem engaged in close collaboration around the optimization process needed for development of formulations, scale-up of production, and eventual validation. In the launch phase of a new drug development project, Bachem was able to act as the contract manufacturing organization by providing manufacturing up to full-scale volumes on a flexible basis, particularly important to customers in early launch when required volumes were difficult to forecast.

A key element of Bachem's partnership with key customers was long-term supply agreements that could stretch over as many as 15 years. Multiple cooperations were also entered for the development of pharmaceutical products, such as with GlyTech of Japan in 2013 that led to the successful codevelopment of Interferon beta-1a for industrial-scale production approved for the treatment of multiple sclerosis.

Bachem was competing in the merchant market for peptides where the company was the clear leader with a global share of about 30%. Three other global companies competed with Bachem, of with the second largest, Polypeptide from Denmark, originated with a team that had left Bachem, Inc. in the USA after the merger with Bachem AG Switzerland. This team went on to develop its own worldwide business, since acquired by a larger Swedish biotech company. The other two merchant

suppliers were in Asia, and there existed many small players who concentrated only on selective research products. Peptide production was generally viewed as a difficult sector to enter.

Building Global Sales and Marketing Footprint

Bachem began early exporting its products beyond Switzerland where the Basel region offered a ready market for its products right at its doorsteps. Sales and marketing centers were first opened in Germany (1988) and in France (1993). The market entry into the US market had previously been accomplished with the opening of a subsidiary in Philadelphia. Up to that point, manufacturing took place in Switzerland only.

The series of acquisitions in the USA during the period of 1997 to 1999 led to a realignment of marketing and sales operations in the USA with focus on two locations in California. The positive experience with this integration triggered a similar move in Europe where Bachem in succession first consolidated its UK units into one operation, and then moved the German operations from Heidelberg to Weil am Rhein (on the Swiss/German border outside Basel), and at the same time merged its French marketing operation into a single European distribution center in Weil in 2003. Marketing and sales responsibility for Europe, India, and Near East were located in the company's head office location in Bubendorf.

Marketing and distribution operations for North America were managed through the Torrance (CA) unit. Sales to Japanese and to customers in China, Taiwan, Korea, and other Asian countries were the responsibility of a recently (2018) opened unit in Japan. For some countries, Bachem signed distribution agreements with firms who stocked the standard or catalog products.

Building a Global Manufacturing Footprint

Although Bachem covered the world market with its product supply, manufacturing was concentrated on six locations in Europe and North America that also doubled as development and marketing locations. Production of chemical substances ranged from milligram amounts for preclinical work to tons for APIs or key intermediates. Equally, the company possessed capacity to produce small molecule generics and new chemical entities (NCE) in multiple tons. Not all production sites were equipped to produce the entire range of products. While Bachem initially produced peptides with equipment acquired from specialized open-market suppliers, such as Büchi, the company over time developed its own processes based on in-house IP.

By far the largest production site was in Bubendorf where Bachem produced since 1971. Production of active pharmaceutical ingredients (API) was cGMP approved by the US FDA, allowing for shipments to many countries and into the important US market. The Bubendorf site also produced research products listed in the Bachem catalog and was approved by the Japanese Ministry of Health for

deliveries to Japan. The second Swiss site in Vionnaz (VS) focused on APIs and complex organic molecules.

The two sites in the USA, Vista (CA) and Torrance (CA), were also FDA approved for cGMP, and the Torrance site was approved for deliveries to Japan. The UK site in St. Helens is concentrated on producing non-GMP research products.

Investments into Other Companies

Both Bachem as a company and founder Grogg over the years invested in various biotechnology or specialty chemical firms. These companies were, or potentially were, customers of Bachem in various forms. Berna Biotech, at the time producer of various vaccines, was the recipient of an investment by Bachem. The company was later acquired by Johnson & Johnson. A second investment was made into the biotech start-up Polyphor, a company for whom Bachem could expect to supply building blocks for its biotech products. Polyphor went public in 2018. A third major investment was made by founder Grogg in Dottikon Exclusive Synthesis where Grogg served on the board for some time and, after stepping down, was succeeded by Thomas Früh, CEO of Bachem. Dottikon was now a publicly traded firm. Dottikon produced active ingredients and served some of the same clients as Bachem. These investments were the result of personal connections between Grogg and the company founders or owners.

Sourcing the Necessary Talent

To find the necessary talent for its main operation in Bubendorf, Bachem was competing with large pharma companies in the greater Basel region. The competition for talent led to higher salaries at pharma companies, often forcing Bachem to recruit its workforce from Germany. Some 40% of the Bubendorf workforce were German nationals, and of those, half commuted daily across the border.

Given the scientific nature of the Bachem business and its industry, the company executive committee was dominated by executives with strong academic credentials and deep experience in the life science industry.

IPO Leading to Change in Governance

Bachem was listed on the Swiss stock exchange by founder Grogg in 1998 when the company had reached about CHF 100 mio in sales. The founder retained about 60% of the shares. Reasons for the IPO were largely private. There were no family members prepared to enter into an operative role at the company. In addition, founder Grogg was said to have had an interest to run a publicly held company after having successfully starting a privately held firm.

According to Früh, CEO of Bachem, there were a number of business and management reasons that spoke for an IPO despite that, being a public company and on the stock exchange, represented more work for management. Top management, who had always been granted shares by Grogg, experienced real value for their holdings. There was also increased transparency, publicly and for customers, as everyone now knew Bachem's business. Once on the stock market, access to capital, if needed, would be easier. To avoid "short-termism," often associated with a public listing, Früh indicated that a company needed anchor shareholders committed over the long term. In his view, founder Grogg with his controlling stake in the company clearly fit that role.

Referring to a change in management and leadership, Früh observed that the change stemming from the IPO in 1996 was less dramatic than the impact of founder Grogg's retirement from active management by relinquishing his CEO role and concentrating on the board chairmanship, as well as his retirement from an active board role in 2011 when Grogg became Honorary Chairman of the board.

In terms of governance, Bachem was subject to the regulatory requirements of the Swiss Stock exchange and Swiss GAP accounting rules. This affected board and committee compositions. In 2018, the Bachem board was chaired by an outside member, Bruno Sommer, with long experience in the life science industry, and 5 other members, the majority being external. One member represented the Grogg family (daughter Nicole Grogg Hölzer), and a second one was previously CEO of Bachem.

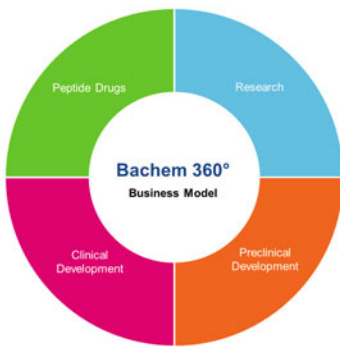
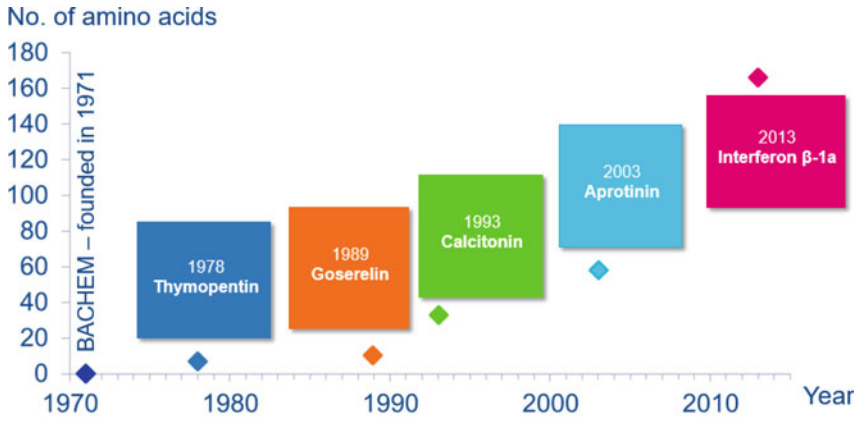

Exhibit 26.24 Bachem product line

Company Profile 27: LEM⁴⁴—Global Leader in Power Electronics. Design Engineers Worldwide “Take an LEM” for Their Systems Design

LEM at the Heart of the World’s Power Electronics

A standard set of modern industrial and office buildings in Plan-les-Ouates, a suburb of Geneva, was the main location of an innovative company whose products have become central to modern power electronics. LEM was a manufacturer of transducers for the measurement and sensing of electrical parameters, such as current and voltage, used in a broad range of applications.

Users relied on LEM for functionality in applications from variable speed drives for electric motors and power supplies for industrial electrical equipment. LEM transducers were used in AC/DC converters, uninterrupted power supply systems, microturbines for wind and solar power generation and, increasingly, in a full range of electrical and battery applications for automotive industry. By monitoring electric current and voltage, electronic systems could optimize use and regulation of power, ensured safe operation, and identified problems before they caused equipment failures.

LEM products were invisible to the consumer’s eyes, yet they were indispensable for numerous power electronic applications. Founded as a limited company in 1972 under the name of Liaisons Electroniques-Mécaniques LEM S.A. In 45 years, LEM grew into a global company with sales of CHF 321 mio (2019) and about 1500 employees, operating in several locations throughout the world, and became listed on the Swiss stock exchange.

An Emerging Entrepreneurial Talent at the Start⁴⁵

The creation of LEM went back to the enterprising ventures of Jean-Pierre Etter (1935), a Geneva-born electrical engineer. After finishing his engineering training, he joined Brown Boveri, a large Swiss company, to work in its small motors department. There he showed his mettle as electrical engineer by quickly finding a way to reduce response times in case of failures at electrical power stations. After a short stint Etter returned to Geneva to continue his studies in physics.

During his student time, he applied for a job with Schlumberger, a major French multinational company. Talking himself into a job despite his lack of English language skills, Etter was sent to the Middle East where he excelled in the

⁴⁴This case was written by Jean-Pierre Jeannot (Professor Emeritus Babson College [USA] and IMD Institute [Switzerland]) on the basis of a company interview as well as publicly available information. Copyright ©2019.

⁴⁵Details on the early career of Jean-Pierre Etter and LEM’s early history were taken from his book, *Start small, grow big, stay human, and conquer the world* (1994), Editions Slatkine, Geneva, as well as based upon a telephone interview.

maintenance and repair of specialist electrical and electronic equipment used for prospecting for oil. He married his hometown sweetheart from Geneva and brought her to Egypt, and they had two children. With Geneva beckoning again, Etter returned with his family to Geneva and brought CHF 120,000 saved from his overseas deployments.

Starting A Consulting Company on a Kitchen Table

Returning to Geneva in 1962, and in need of employment to support his family, he invested his funds into an engineering consulting company led by his elder brother Marcel, a talented physicist with a degree from the local university. Marcel had been working for the Battelle Research Institute in power electronics, and the two brothers were intent on growing their consulting office. Ten years later, CHF 100,000 in debt, Jean-Pierre Etter believed that their business model would never lead to success. The Etter brothers had invented and patented new technologies with the expectation that larger companies would adopt or buy the ideas and pay royalties. This business model failed as companies began to start their own research departments and did not want to rely on outside technology suppliers for the engineering of their products.

Starting Up LEM as an Industrial Enterprise in 1972

In 1972, following 10 years of failing to get any large-scale adoptions of their inventions, Jean-Pierre Etter struck out on his own creating a new company and incorporated it as LEM. Etter contributed half of the required start-up capital of CHF 200,000 in the form of intellectual property and in a matter of weeks had raised the additional capital needed from about 15 different Geneva individuals. Etter began by selecting just two of the patented ideas from the engineering consulting firm to commercialize. One of those dealt with measuring electric current.

Learning from the failures to convince companies to accept their technical inventions, Etter was looking for companies that might be interested in coinventing and codeveloping it jointly into a working system. Etter was also looking for well-known companies which might, indirectly, get others to adopt this new approach. The first major contract for LEM was equipping 60 Geneva trolleybuses with 300 A transducers built by Brown Boveri, the first substantial order for CHF 24,000. The local Sécheron company, with whom LEM was collaborating, introduced LEM to the French TGV train builders, in return triggering an introduction to GE in the USA and to Chinese railways which resulted in many other opportunities for applications. Railway and transportation applications became an important user segment for LEM although over the years it was eclipsed by other segments.

The early phase of the LEM company history culminated in its going public on the Geneva Stock exchange in 1986 when LEM had achieved sales of CHF 9.5 mio and a net profit of about 965,000. Prior to the IPO, LEM Holding, domiciled in Fribourg, was founded and held the totality of LEM SA shares in its portfolio. Going

public allowed LEM to tap into additional capital resources and expand its business, including acquisitions.

As company founder and important shareholder, Etter did not mind seeing his holdings diluted by inclusion of other shareholders. He personally voiced his fears that remaining a major shareholder of a growing and profitable company, he stood the risk of becoming a financier and feared he might favor personal financial priorities over the interest of the company's future development.

Expanding LEM Business Activities

The years from 1986 to 2005 were characterized by broadening of LEM's business focus, following the IPO on the Geneva Stock exchange and making several acquisitions abroad, as well as investing in an industrial park outside Geneva.

Etter and LEM were able to obtain building rights to a significant tract of land in Plan-Les-Ouates outside of Geneva City, through a contract with the Geneva Cantonal authorities. On this real estate, LEM constructed a New Technology (CTN) Center and invested more than CHF 106 mio for a center of more than 50,000 m² of useable building space. Financing was partially done through a capital increase of CHF 30 mio. LEM moved its operation into the new center where the company was joined by roughly 40 other firms. The center was separately incorporated and capitalized at CHF 50 mio in 1997.

The additional financial resources obtained as a result of the IPO allowed LEM to speedily expand its international market coverage. Subsidiaries were created in rapid succession: in North America, Germany, and Sweden in 1987; in Japan (1998); in China and the UK in 1989; and a joint venture in Russia (1990). The international expansion came with the realization that LEM's customers were all over the world and the company needed to be near them.

In parallel, LEM expanded beyond its original component transducer business into testing equipment. The first testing equipment was delivered in 1987. An acquisition in the UK in 1989 provided the entry into the instrument market, followed by a takeover of the leading US competitor in 1992, a Swiss supplier in 1993, and an Austrian instruments company in 1995. During this time, profitability of the instruments segment exceeded that of the component business, leading to a forced expansion into the equipment direction.

This expansionary period (1986–1997, LEMs 25th anniversary) resulted in rapid sales growth with LEM sales surpassing CHF 50 mio in 1993 and CHF 100 mio in 1997.

The added complexity of the business resulted also in a change of management at LEM. The company was restructured into two business areas, components and instruments, and two business units, testing systems and high current systems. In 1989, Etter recruited Patrick de Bruyne to join LEM as operational head, becoming himself CEO and board member from 1993 to 2004. When Etter decided to

relinquish the chairman role, de Bruyne took over on an interim basis until the recruitment of Fritz Fahrni as Chairman in 2000.⁴⁶

A Period of Narrowing the Business Focus

During LEM's early phase, both the instrument and equipment sectors, as well as components were profitable. However, this was beginning to change after the turn of the century, with the component business picking up substantially as more and more applications were developed. The instruments and equipment business became a drag on LEM results. In addition, the instrument business required much higher capital intensity. Although there were a few technological synergies between the instruments and the component business, the sales process and the customers to be addressed were different, as were the business model and the potential to scale.

LEM thus entered into a period of divestment and retrenchment, returning to its core component business. The high current system business was divested through a MBO in 2003. A strategic audit conducted by a consulting company resulted in the decision to divest the entire instruments business to a US buyer for about CHF 55 mio. The instruments business had accounted for one-third of LEM sales or about CHF 65 mio. At about the same time, LEM managed to divest its real estate in the industrial park CTN.

The combination of these divestitures brought a cash flow of approximately CHF 30 mio. The net inflow was used to reimburse shareholders for CHF 30 mio, the amount of capital raised in 1989.

A Period of Refocusing the Business on Components

During the chairmanship of Fritz Fahrni (until 2005, regular member until 2009), Felix Bagdasarjanz (2005–2013), and Andreas Hürlimann (since 2013), LEM turned itself into a pure play in components and profitably grew component sales from CHF 98 mio to CHF 321 mio by 2019.

When LEM started out in 1972, the company had already learned from the previous engineering consulting business that the business of inventions and selling licenses to potential users was not going to be fruitful. Etter and his LEM colleagues then turned around and moved into the direction of co-engineering or codevelopment, which would result in components customers wanted and those components would be ordered from LEM. Many components, once designed into new products or systems, enjoyed on average a product life cycle of up to 8 years, in some exceptional cases reaching even several decades. To make this work, LEM had to invest in a direct sales network with many local contacts into many different

⁴⁶Fritz Fahrni was a well-known industry leader as former CEO of Sulzer Technology Corp. and Professor at both ETH Zurich and University of St Gallen (HSG).

industries, thus creating an ever-growing set of applications. The acquisition of the Danish company Danfysik brought technical experience in additional areas such as medical scanners, precision motor controls, and test and measurement equipment.

The search for high-volume niche applications was an important activity at LEM. While enabling megatrends such as electronics or digitization, automation mobility, or renewable energy and energy efficiency were driving the dynamics in main segments, one still had to locate specific niches where, once chosen, the company could be No. 1. *Once such a niche has been identified, it was important to drive it, be consistent, and with all that is needed to go after it* (Hürlimann).

With this business model, LEM sent sales engineers around the world to many large potential users, such as ABB. LEM engineers provided free technological and engineering advice in designing its components into the products resulting in a virtual lock-in. LEM, to use a terminology from the automotive industry, saw itself as a Tier 2 supplier selling to Tier 1 companies (such as ABB) who in turn are selling to OEMs such as Stadler Rail, Bombardier, or Siemens. LEM components were critical to the reliability and efficiency of the end-use product. LEM had become the leading supplier with sales of three times the size of its next biggest competitor.

Finding Global Niches

Although LEM was focused on selling components, or transducers, only, the company had built up over time a wide range of industry sectors where company or product-specific components were sold. Railway and trackside applications were the first segments penetrated. Over time, industry applications, such as for robots, for energy and automation, eclipsed the rail sector, followed by a wave of renewable energy applications in solar and wind. Given their different economic cycles (from early to late cycles), the variety of sectors provided for diversified businesses and stable sales while maintaining product focus.

More recently, the automotive sector was gaining increasing importance. In response to this segment development, LEM reorganized itself again and separated the automotive component business from the other industry applications. Although at the beginning (2004) accounting for close to CHF 2 mio in sales, the segment grew faster than other parts of the business and reached CHF 71 mio by 2019, accounting for about 22% of LEM sales.

Articulating the Sales Model

In line with LEM's business model, the company aimed at going direct for countries or markets with annual sales of CHF 4 mio or more. At that level, LEM could establish a sales subsidiary. Below that threshold, the company was using distributors and catalogs. The need to be close to customers led to the establishment of more than 20 sales offices across the world. Its global customer base demanded seamless service worldwide.

LEM also had to accommodate different selling cultures. In the US rust belt, or Midwest, the sales approach was traditional, whereas in the Silicon Valley there was a different kind of engineering thinking. This meant that LEM had to cope with various customer cultures within the same client organization.

Different market segments experienced different sales dynamics, and so were its geographies. Currently, China and Europe each accounted for 33% of sales, and North America about 13%, and the rest of the world for 20%.

Enlarging the Manufacturing Footprint

LEM was a volume producer of high-quality products on automated production lines combined with skilled assembly and testing. Its product line was comprised of more than 2000 separate models with prices ranging from below CHF 1.00 per unit to several CHF thousand for selective components. Although the company did not divulge production volumes, outsiders have estimated the output at more than 60 million units.

In line with the evolution of LEM sales, its manufacturing setup changed. When the company commenced operation in 1972, everything was Geneva-focused. With the founder's strong ties to the local community and government, relocating operations was not a consideration. However, given the increasing price pressure, relocating assembly lines into cost-competitive countries accelerated during the previous and current decade.

Geneva continued to employ a significant workforce of 280 with its composition changing over time. Gone were the high-volume production and assembly lines. An ever-increasing number of staff worked in product management, R&D, industrial engineering, front-end innovation, marketing, supply chain management, and sales. The Geneva site still produced the specialty components, was involved in prototyping, and checked and verified new production lines set up elsewhere.

The largest concentration of LEM employees was in China with a workforce of about 900. China was at first an important market for LEM, turning also into an important production point. China was rapidly becoming the largest single market for LEM with about one-third of sales. More than half of LEMs production capacity was now in China.

In Europe, the largest production center was in Bulgaria where LEM employed about 260. The Bulgaria expansion was both a response to bring the Euro-denominated sales and production in balance, as well as leverage the local technical university in Sofia for engineering talent.

In the USA, LEM maintained a customization hub to adapt modules to US standards in terms of software, cables, and other interfaces. Japan was still a small production base focusing on local product specialties as well as on sales to Japanese customers.

Research and Development Function

For LEM, development was crucial to further develop the efficiency and quality of its components. The company invested about CHF 28 mio annually into R&D (2019) or about 9% of sales. Product families were constantly improved, updated, and functionally extended to keep pace with the changing requirements of its customer base.

LEM was constantly hiring technical talents from universities. Once hired, they needed first to be trained. A full range of engineering disciplines were required, all the way from mechanical to electronic engineering, process automation, and mathematics. At the Geneva location, it was not easy to recruit for technical disciplines. LEM had to reach out to the nearby French cities Grenoble and Lyon.

Product development and talent development was decentralized and had to be close to customers. Engineers for Huawei, i.e., in China, had to be located in China; it did not make sense to make a loop through Geneva for each issue.

Financing and Raising Capital for LEM

LEM had a long experience with being a listed company, dating back to 1986. With its listing on the Swiss exchange, LEM had access to capital if needed. With a steady cash flow of more than 10% of sales, the company was in a position to finance its own capital needs internally from own resources. The healthy profitability of 24% in total annual shareholder return during this period allowed for a targeted dividend payout ratio of in excess of 50%, appreciated by its shareholders.

The public listing was viewed as a positive force by LEM management. The transparency required for a public company brought a healthy discipline, and there was a certain “window effect” that made management work harder as the results were clearly measured.

Foreign exchange fluctuations played a role in LEM’s business. The company strove to naturally hedge its business by bringing both sales and production currencies into an equilibrium to avoid exposure on the Swiss Franc location.

Stability in Ownership and Governance

Governance was of course driven by Swiss stock exchange requirements. What was notable for LEM was its stable set of shareholders. Two core family shareholders accounted for slightly more than 50% of shares. This brought stability to the company and did, as a result, raise the importance of the board chairman interfacing between shareholders and management in terms of monitoring performance.



Exhibit 26.25 LEM product line

Company Profile 28: Acutronic⁴⁷—World Leader in Precision Motion Simulators. Simulating Centrifugal Forces, Flight Profiles, Temperature, or Pressure Conditions

Swiss engineer Leo Marxer founded Acutronic in Rapperswil (SG) in 1973, and the company had ever since been active in first distributing, then developing, designing, and manufacturing precision motion simulators, becoming the global leader in this clearly circumscribed market niche. Precision simulators were used in testing and calibrating inertial sensors, inertial navigation systems, stabilized optronic systems, as well as in simulating flight motion of missiles. The name Acutronic, a fusion of “accurate” and “electronic,” served the purpose of being alphabetically listed upon front everywhere. Acutronic produced single to five-axis (flight) motion simulators, inertial guidance test systems, target & centrifuge systems, and other testing systems. In 2018, company locations were in Switzerland (Bubikon, ZH), USA (Pittsburgh), and production facilities in Olten (Canton SO), generating revenues of CHF 40 mio with 120 employees, 60 of them in Switzerland. Recent acquisitions in the USA, Spain, and India increased employment to 150. Acutronic’s main user industries were aeronautics (30% of total revenue), space (30%), defense (30%), and automotive & consumer industries (10%). The company estimated its global market share at 50%, almost 100% of the Swiss production going to export.

Changing from Distributor to Manufacturer

Prior to the foundation of Acutronic, the market for positioning tables was dominated by American suppliers, such as Fecker Systems (founded 1920), CARCO Electronics (founded 1961), Contraves Goerz (founded 1967), and Benton (founded 1975). At that time, Contraves Goerz was looking for a distributor of its products located in Switzerland. Leo W. Marxer (1931), who had worked for Goerz Optical Co in the USA during the 1960s, won the contract to distribute Goerz motion simulators, founding Acutronic for this purpose in 1973. The unwillingness of the dominant American motion rate table suppliers to customize their products to local needs (i.e., local manufacturing, metric measurements, and customer support) created a window of opportunity for the new company.

At that time, infrastructure support for a start-up company conducting its business internationally was not easy. According to the founder, contacting foreign customers, for example, required considerable organization: *We had to pre-announce our international calls, drive to the Post office for telex communication in the village, and be “short and precise” because it was so expensive.* In the 1980s, after a few years as Goerz distributor, Acutronic had the opportunity to

⁴⁷This profile was written by Heiko Bergmann (Adjunct Professor of Entrepreneurship University of St. Gallen) on the basis of a company interview as well as publicly available information. Copyright©2019.

deliver position tables and to become a maintenance and repair organization (MRO) for the European Tornado jet fighter program. This was the kick-start for Acutronic to shift from distributor to manufacturer, leaving behind its role as trading company only. Acutronic leveraged the Tornado business project clients all over Europe, setting up subsidiaries in Germany, France, and the UK. Specializing in developing a wide range of motion simulators tailored to the needs of European customers, Acutronic established itself as the leading supplier in Europe.

Opening of US Subsidiary

The creation of an independent entity to serve the US market was an important step in the development of the company. Acutronic USA, founded in Pittsburgh in 1989, capitalized on the importance of the space & defense industry in the USA. US regulations regarding confidentiality in defense & aerospace required the Swiss and US entities to operate at arm's length, necessitating development and construction operations to be maintained at both locations, working independently of each other. While such duplicate structures made no sense economically, they were necessary and meaningful from a political perspective. Acutronic USA was staffed completely with US citizens. No Swiss flag was flown in front of the Pittsburgh office. Customers typically were unaware that Acutronic USA was owned by a Swiss company, considering it a US business. Through its US entity, Acutronic served all important customers of the US defense and aerospace industry.

In 1989/1990, Acutronic introduced its first digital motion controller, the ACUTROL[®]. The patented and truly universal controller was a distinguishing feature compared to competitors and soon became the new industry standard. In the mid-1990s, however, company development did not run smoothly. Following risky and difficult projects at its French subsidiary involving g-force simulators for humans, Acutronic encountered financial difficulty and came close to bankruptcy.

Founder Bowing Out

In June 1996, Thomas W. Jung (1966) acquired Acutronic for CHF 4 mio from UBS and Leo Marxer, the company founder. Jung had a family business background and had worked previously for DaimlerChrysler Aerospace in Munich. For family reasons and attracted to the challenge of running his own business, he decided to move back to Switzerland and bought the financially distressed company. The purchase was largely financed with help from his family.

Assuming control of Acutronic at the age of 30, Jung began by restructuring, closing the French, German, and UK subsidiaries. Realizing that the company had been active in too many areas, he subsequently refocused Acutronic on its core competence of motion simulation systems.

Focusing on Core Competences

Acutronic considered the development, design, and assembly of precision motion simulators its core competence. The company built its power amplifiers and control-related technical parts in-house since products available on the open market would not fulfill the company's exact requirements. Control loops, and engineering know-how, were crucial due to high accuracy requirements demanded by the industry. Despite the fact that most other parts used for Acutronic systems could be bought off the shelf, it was very hard to reach the accuracy and performance demanded. The company sourced a big portion of all noncritical parts from external suppliers and focused on engineering, electronics, as well as assembly to keep costs in check and remain price competitive. Due to efficient processes, unit costs at Acutronic were comparable to competitors located in other countries, despite higher labor costs in Switzerland.

Acutronic returned to profitability in 1999, reaching revenues of CHF 25 mio by 2004, more than doubling its size since 1996, achieving market leadership. The group employed a staff of 70, with employment in Switzerland reaching 30. In 2005, Acutronic took over its largest US competitor, CARCO Electronics, gaining important IP and know-how for hydraulic-assisted simulation systems. Focused on applying its strict niche strategy on an international scale and serving relevant motion simulation markets in Europe, the USA, and Asia from its Swiss and US operations, Acutronic established itself as the dominant player in the motion simulator market.

Customizing Motion Simulators for the Long-Term

In 2006, Acutronic invested close to 10% of sales in R&D, maintained active partnerships with many educational institutions, and executed continuous quality and efficiency improvement programs. The focus of R&D was on developing next-generation core capabilities, as well as on improving the power and accuracy of current solutions, winning several awards for building technological skills. Depending on the application, 6–12 months of development were invested on average in a motion simulator used to simulate centrifugal forces, flight profiles, or temperature and pressure conditions. In most cases, the single- to five-axis systems were customized prototypes that could be used to test and calibrate laboratory instruments, simulating reality.

While price mattered, it was not the only decisive factor. Customers were also considering Acutronic's track record and corporate strength. According to Jung, buyers needed *a supplier that can guarantee up to thirty years of product availability and long-term reliability*. In 2019, Acutronic offered maintaining and refurbishing inertial guidance test systems and hardware not only for loop equipment supplied by Acutronic, but also for that of the predecessor companies CARCO, Contraves Goerz, and Benton, although some had been put into service more than 20 years earlier.

Recruiting Talent

By 2010, Acutronic reached revenues of CHF 40–50 mio and employed a staff of 120, reaching a market share of about 50%, winning several awards, received the ISO-9001 certification, and expanded into new markets such as the automotive industry. In Switzerland, it was not too difficult for Acutronic to find well-trained staff, including on the junior level, to support its growth, due to the proximity of technical institutions of higher learning, as well as profiting from a general high education level. As an apprenticeship program sponsor, the company took responsibility to internally train employees. Switzerland's focus on quality, reliability, and punctuality also made it easier for Acutronic to meet its promises.

In the USA, finding staff that satisfied Acutronic's specific demands proved more difficult. Acutronic's employees stayed with the company for a long period, allowing it to fill management positions internally, if possible. In an interview, Jung highlighted the high commitment of employees, in some cases: *We had to take away the key of the building from certain employees to prevent them from working 24–7.*

Surviving the Financial Crisis

In 2011, the global financial crisis impacted Acutronic with full force. Customers delaying orders combined with the appreciation of the Swiss currency made Acutronic's products more expensive and lowered its margins. With revenue down 30%, Acutronic had to lay off one-quarter of its employees. However, in 2012, the company was able to recover quickly and boost sales and employee headcount. For years, Acutronic felt the impact of the strong Swiss currency and the high operating costs but found ways to cope with it.

Passing the Torch to Yet Another Family

After spending almost 20 years with Acutronic, lacking a successor within his family, Jung sold the company in 2015 to the Aigrain family. Since its start, Acutronic had always been family-owned (first Leo Marxer, then Thomas W. Jung, and finally the Aigrain family). Jung could have sold the company to a private equity fund or to a corporate owner, but he preferred instead to keep the company in private hands. Under private ownership, Acutronic management had enjoyed greater independence than was viewed possible with a publicly owned company. Transferring the company to private owners, Jung explicitly tried to preserve the strategic focus and identity of Acutronic.

The previous acquisition of Carco had been financed with internal funds only. Since 2015 and with the acquisition by the Aigrain family, Acutronic was partly financed by bank debt.

Prospering Under the Aigrain Era

When the Aigrain family bought Acutronic in 2015, Jacques Aigrain, former President of Swiss Re, assumed the role of president of the board of Acutronic Holding. His son, Florian Aigrain, who had worked previously for 5 years at Goldman Sachs, became CEO of the holding and the president of the board of Acutronic Switzerland. Subsequently, the Acutronic group was restructured into the four functional divisions for Commercial, Operations, Development, and Group Resources to increase the company's agility and flexibility. By creating a joint global leadership board consisting of top management of both Swiss and the US operations, collaboration between the two units was enhanced.

In 2016, the "Acutronic Ventures" initiative was started in order to pursue new growth opportunities in sectors such as industrial components, robotics, drones, and autonomous systems. The company formed Acutronic Robotics as a new division and acquired Erle Robotics, a leading robotics and drone start-up based in Spain's Basque region. The new division focused on the three primary business lines of development and commercialization of Hardware Robot Operating System (H-ROS) as well as robot and drone interoperable hardware products and B2B engineering services for corporate and governmental clients.

According to CEO Florian Aigrain, Acutronic had always been regarded as the "Rolls Royce" in the motion simulation industry, heavily focused on quality, productivity, and cost-efficiency as main competitive differentiators.

Company Profile 29: LNS Group⁴⁸ —Automating the World's CNC Machine Tools. World Leader in Machine Tool Peripherals

Conquering the World from a Small Village in the Jura Bernois

Orvin, a small town with 1200 inhabitants in the Arc Jurassien, a short drive from Biel/Bienne in the French-speaking area of the Jura Bernois, was in the midst of a region where many small machining companies produced high precision parts for many industries, including the regionally dominant watch industry. LNS Group's head office had been located there for over 40 years. Intended as a project between three industrialist friends, a company emerged that spread its wings worldwide to reach sales of about CHF 200 mio, employed 1000 people worldwide, and reached the dominant global position in machine tool peripherals that automated manufacturing processes. Exporting some 90% of its production, the company supplied about 25,000 machine tool peripherals (bar feeders, chip conveyors, air

⁴⁸This company profile was written by Jean-Pierre Jeannet (Professor Emeritus Babson College [USA] and IMD Institute [Switzerland]) on the basis of a company interview as well as publicly available information. Copyright©2019.

filtration systems, and high-pressure coolant systems) annually from several production bases.

The Critical Role of Bar Feeders

For many production processes requiring machined parts on a volume basis, manufacturers used metal bars, usually about 3 m long, and fed them into CNC lathes. The bar feeder allowed for automatic production, since bars did not have to be manually advanced into CNC turning machines. Parts manufacturers therefore were employing bar feeders in a wide range of manufacturing processes for the watch industry, luxury industry, medical industry, electronic industry, transportation, energy oil & gas, and machine production. In all of these, bar feeders became indispensable in allowing to reduce cost-per-part while keeping quality constant.

Starting as a Project Between Friends

André Léchet owned a small workshop in Orvin. He was an engineer who had *a new idea every day* (Scemama). He was an engineer at heart, not an industrialist. One day, his cousin, who ran a parts manufacturing company in Orvin, turned to him about resolving the recurring problem of manually feeding metal bars into turning machines. André Léchet developed a solution for his cousin that became the basis for feeding metal bars automatically into turning machines.

Léchet turned to two friends for the commercialization of his solution. First was Walter Neukomm, a toolmaker working for Tornos, a large CNC turning machine manufacturer in the area. He brought the industrial manufacturing knowledge to the project. Second, Léchet pulled in Maurice Scemama, owner of a machine tool shop located in Biel/Bienne and a gifted salesman who was selling specialty machine tools and tools to the many watch industry suppliers in the Arc Jurassien. Traveling by bike or train throughout the Jura, he had built up an excellent network among the specialty and precision parts manufacturers.

The mechanical genius (André Léchet), Mr. Industrialization (Walter Neukomm), and the consummate salesman (Maurice Scemama) joined to found LNS in 1972 with the purpose of commercializing the automatic bar feeding opportunity (Scemama). The company name, LNS, stemmed from a combination of the first letters of the three founders' last names.

As LNS commenced operation in Orvin in early 1973, Walter Neukomm became its first CEO, remaining in that position until his sudden death in 1979.

Convincing Customers of Their “Pain”

Although the development and construction of the first bar feeder came in response to a request by one of the founders' cousins, further sales had to be fought for. About

3 years into the start-up, an LNS customer had found a way to add oil to the bar feeder, alleviating many of the side effects of the machining process. LNS acquired the rights to the idea and went on to engineer the final concept. This technology improvement was patented by LNS and branded as Hydrobar[®].

The process of turning parts from metal bars created considerable energy in the form of heat. Vibration was hard on the lathe components and affected output and machine parts. The entire process created substantial amount of noise. Bar lubrication allowed for reduction in heat and energy production, reduction in vibration, and in noise. CNC machines could now run at 6000 rpm, substantially surpassing the former standard of 3000 rpm.

Potential customers were simply not aware of their own “pain” and that an LNS automatic bar feeder could alleviate this. This was the time of “hard sell” to make potential customers aware of the benefits of the LNS bar feeders.

Market Development and Rollout

Initial sales of LNS bar feeders were to the local market, the so-called Arc Jurassien, of the region between Solothurn, Biel/Bienne, and La Chaux-de-Fonds. The first exports were to Germany where a sole agent was appointed in 1973, later to be acquired and turned into a sales subsidiary in 2015.

LNS bar feeders were not stand-alone equipment. Instead, they were engineered to be plug-and-play compatible with a range of OEM lathes. Leveraging this connection, LNS first sold through the machine tool OEMs. This strategy to focus on the OEMs and machine tool dealers has proven successful over the years and remains the main customer focus group of LNS. While an OEM lathe might sell for CHF 250,000, a bar feeder sold on average for CHF 25,000. For dealers, these were peripherals, allowing them extra income and in some cases offering even better profitability than the OEM machines.

To support sales into international markets, LNS began to create its own sales network to better control the markets. The US sales network was created in 1984, followed by France and Italy in 1990, and then the UK in 1992.

Expanding Beyond Bar Feeders into Additional Peripherals

By the late 1990s, LNS had developed the largest global sales network for bar feeders. With margins declining due to emerging competition, the company began to think about ways to monetize this large sales force by piggybacking on related products.

At this time, Turbo Systems, a US-based company selling chip management systems to the same customer base using LNS bar feeders, approached LNS. Chip management systems were also engineered into the OEM machines and automatically collected the chips created from machining. The US company had about the same amount of sales as LNS, but in contrast did not have its own sales force. In

2002, LNS acquired Turbo Systems Inc. Founded in 1984, the Turbo company founders wanted to retire. With 150 employees in the US facility near Charlotte, NC, and in a small unit in the UK, this represented a major step forward greatly helped by Yves Scemama, one of the sons of the LNS founder, who had previously moved to the USA and was active in the LNS US operation. Today, chip conveyors accounted for about 30% of global LNS sales with about 11,000 units sold annually.

Integrating Turbo Systems chip conveyors into the LNS sales force proved to be a major challenge and required quite a bit of engineering as chip conveyors were situated inside the machine tool and therefore each chip conveyor had a specific design. It took about 5 years until the LNS sales force was comfortable selling Turbo Systems chip conveyors to their bar feeder customers.

In 2011, LNS took another step in acquiring an Italian company, manufacturing air filtration systems that could be connected to the same CNC machines using bar feeders and chip conveyors. Work holding and coolant management systems were completing the strategy of a one-stop-shop offer for CNC machine operators.

Expanding into Japan

Japan had long been an important market for LNS, but it took three attempts until LNS could finally establish a firm foothold. Japan was a market with a large number of installed CNC machines and lathes, all prospective “customers” for LNS one-stop-shop products, and was served by local suppliers. In its first attempt, LNS started by appointing a large Japanese trading company specializing in all types of machine tools as its agent. When results were disappointing, the Japanese agent suggested to form a joint venture. LNS then founded Nippon LNS in 1991 as a joint venture, but results were still disappointing given the large potential of the Japanese market.

The breakthrough occurred in 2012 when LNS could acquire a Japanese company. Yoshida Tekko KK had been founded in 1981, and its owner wanted to retire. With more than 100 employees, the company specialized in producing chip conveyors and coolant management systems, two areas that were a perfect strategic fit for LNS. The company renamed LNS Japan continued to serve its markets with chip conveyors, as well as selling other LNS peripherals, which were sold to the same customer group. As an extra bonus, LNS was able to transfer Yoshida’s advanced filtration systems to be produced by LNS in markets outside of Asia.

Expanding Throughout the Asian Region

LNS had started to develop its business in a number of Asian markets, but real success came with the acquisition of 51% of Fedek in 2000, and LNS acquired the entire company in 2003. Fedek was a producer of bar feeders of lower complexity and exported its products to other Asian markets, China in particular. LNS started with a first production operation in China in 2001 and moved into a new factory in

2008 where about 110 persons were employed. The size of this new factory was doubled in 2013 and now represents over 13,000 m². The Chinese operation specialized in producing one-stop-shop peripherals for China, but also in subassemblies for the rest of the group.

Realignment of Manufacturing and Engineering Footprint

The establishment of Japanese, Taiwanese, and Chinese manufacturing centers and the acquisition of Turbo Systems and ChipBlaster in the USA led to a complete realignment of manufacturing mandates through the LNS group of companies. The supply strategy was based on manufacturing in three regions: the Asian production centers concentrating on supplying Asian markets; the USA, with a staff of 300 across three production sites there, on North America; and the European factories in the UK, Italy, and Switzerland focusing on supplying European customers.

At the Swiss site in Orvin, the regionalization strategy impacted on staffing levels. Focus was then put on functions of higher value-added functions, such as Leadership, R&D, Marketing, Operations, Finance, and less on direct production. Overall, the Swiss site produced only about 20% of the LNS Group revenue. R&D activities for bar feeders were carried out in Switzerland and Taiwan. Since the key elements of engineering and design were concentrated in Switzerland, LNS traded under a Swiss engineering label.

Business and Sales Model

As seen previously, LNS always focused on selling their equipment through the machine tool manufacturers (OEMs) or through the machine tool dealers, which had been successful, since OEMs' and dealers' sales networks indirectly became LNS' distribution network.

Much of the LNS sales model was built around its service function. Worldwide, LNS maintained sales and service staff of 150, plus another 50 on contract. Service personnel were stationed within a maximum of 2 h travel time from the equipment. When LNS would open up a new market or region, the company would start first with deploying sufficient service personnel. Sales and service staff were located either in subsidiaries, sales offices, or specialized service centers.

LNS' globally installed base of over 160,000 bar feeders, 140,000 chip conveyors, 13,000 air filtration systems, and 35,000 high-pressure coolant systems created a growing parts and service business making up 15% of sales.

LNS sales were 40% in the USA, 30% in Europe, and 30% in Asia. Bar feeders accounted for about half of sales with a 4-week lead time for orders. Chip conveyors were the second most important product family in terms of sales, followed by air filtration systems and high-pressure coolant systems. Parts and service also represented a significant proportion of sales.

With its number one position worldwide and diversified product portfolio, LNS does not have any global competitors. However, there were regional competitors with strong market positions, competing on specific peripheral types.

Building a One-Stop-Shop Portfolio of Peripherals

With the acquisition of the Italian air filter manufacturer FOX in 2011, the strategy of becoming a one-stop shop became formalized. LNS thus offered a range of bar feeders for different levels of automation, a range of chip conveyors, as well as a range of air filtration systems, all of them engineered to plug-and-play compatibility for a full range of OEM CNC machinery suppliers.

The one-stop-shop portfolio of peripherals was further enhanced with the acquisition of the US market leader of high-pressure coolant systems ChipBlaster in September 2018. ChipBlaster had a leadership position in the North American market and the plan is to grow sales of the high-pressure coolant systems through LNS' global Sales and Service network.

Management Evolution and Ownership

LNS remained a privately owned company. After the unexpected death of Walter Neukomm, company co-founder and first CEO, co-founder Maurice Scemama took over the board chairmanship and a number of different external CEOs were hired. In 1987, Philippe Scemama, son of the co-founder, started working for LNS and assumed the role of CEO as of 1995. In addition to his role as CEO, Philippe Scemama stepped into the Chairman's role in 1998, his sole position since 2008 after having transferred the CEO position to a nonfamily member. His older brother Yves joined the US operation of LNS in the early 1980s and remained there. After the acquisition of Turbo Systems, the North American business unit CEO became LNS Group CEO. The current LNS Group CEO Gilbert Lile joined the company in 2007 as chief marketing officer, assuming the role of Group CEO in 2014, after being business unit Europe CEO since 2011.

As a private and yet globally operating company, LNS was subject to changes in the global economic environment. In 2009, during the global financial crisis, many customers stopped investing in capital goods and group sales declined by almost 65% with LNS recording a loss. In order to avoid a workforce reduction in Switzerland, following the Swiss Franc shock of 2015, the company increased sourcing in the Eurozone and in Asia. LNS was well hedged in terms of exchange rate risk, with production facilities in the major industrial regions. This allowed LNS to have production costs in the same currency as the sales revenue. Partly in order to improve the handling of investments and enterprise financing, LNS created the LNS Holding SA.

Current owners of the company are the three descendants of co-founder Maurice Scemama, namely the two sons Philippe and Yves and their sister Geneviève.

Passing an Empty Factory Building on Leaving Orvin

Leaving LNS buildings in Orvin, the visitor cannot help but notice the structures next door with the company name Precimed still visible. Precimed was once a thriving business producing high precision medical instruments used in connection with orthopedic surgery. The company grew rapidly and reached close to CHF 125 mio in sales when it was abruptly sold in 2007 to a US company following a fallout among its shareholders. When the Swiss Franc appreciated in value vs. both Euro and US Dollar, the new owners closed the factory and assigned production to US plants. The buildings were vacated, and all industrial activity ceased. In contrast, LNS and its owners navigated the same challenges to remain active and maintain their business in Orvin, although growth took place in other parts of the world.

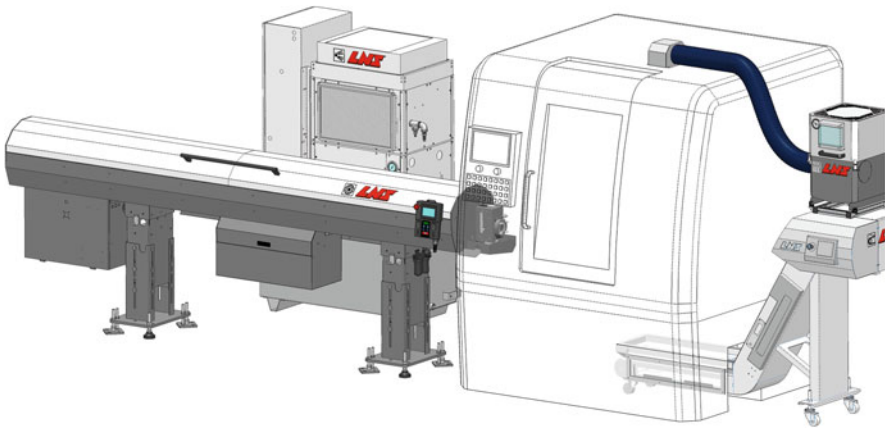

Exhibit 26.26 LNS system

Company Profile 30: Thermoplan AG⁴⁹—Global Leader in Automatic Coffee Machines for Restaurant Use. Supplying the World’s Leading Coffee Chains

From Railway Station Master to Coffee Master

When Domenic Steiner left his secure job as station master of the SBB Arth-Goldau station to follow his long-held dream to become an entrepreneur, no visible path was discernible that his yet to be created business, located in a small town on the Lake of Lucerne, would someday supply automated coffee machines to one of the world’s

⁴⁹This company profile was written by Jean-Pierre Jeannet (Professor Emeritus Babson College [USA] and IMD Institute [Switzerland]) on the basis of a company interview and public information. Copyright©2019.

largest coffee chains, employ about 300 and ship more than 20,000 coffee machines annually, and clock up an estimated CHF 300 mio in sales.

Building Institutional Kitchens as a First Business

Domenic Steiner had always been the restless type. Born (1937) and raised in Olten (SO), he began his professional career attending a program for traffic management (Verkehrsschule) and joining SBB, the Swiss Federal Railways, where he rose to the position of station master for Arth-Goldau, an important station on the St Gotthard line. In 1974, aged 37, he decided to act on his desire to become an entrepreneur, quit the safe job at SBB, and moved with his family to Küssnacht a.R., on the Lake of Lucerne.

Steiner, with his wife Esther as partner, founded Thermoplan AG. The Steiners operated without a business plan. They initially concentrated on a HVAC installation business, building professional kitchens for institutional customers and restaurants, combining both carpentry and HVAC skills. Thermoplan's first international order was for a hotel kitchen in Greece.

Building a Cold Cream Whipping Machine Business as a Second Business

As part of his kitchen installation business, Steiner regularly attended industrial fairs which attracted hotel and restaurant kitchen designers and operators. In his conversations there, Steiner learned that one of the notoriously difficult elements of restaurant kitchens was the cream whipping equipment. He had installed many of them and knew they were bulky, difficult to clean, and kitchen operators complained that they were often a stumbling block to get clearances by food inspectors. Clearly, whipping cold cream was a "pain point" for restaurant and hotel owners. In parallel, rising concerns around CFCs (Montreal Protocol) prompted authorities in some countries to ban Kisag cream blowers.

The insight into this issue made Steiner look for a team to solve this problem. Together with a local mechanical workshop, known for its tinkering skills, they solved the aeration problem and in 1983 brought a cold cream whipping device on the market that was half the size of existing equipment, considerably more user-friendly, and allowed to connect a Tetra Pak cream container. This simple device, branded "S'Whipper," conquered the world. Within a few years, the company was represented in 60 countries, leading to building its first manufacturing plant in the nearby community of Weggis in 1985.

Surfing the Cappuccino Wave as the Third Business

In 1991, at another kitchen equipment show, Steiner realized that the emerging trends toward cappuccino coffee and lattes would offer a new opportunity for creating equipment that would produce hot milk foam at the press of a button. Launched in 1993 under the brand name of “Faomino,” Thermoplan’s new equipment was designed on the same principles as its cold cream whipper. In a short period, Thermoplan became global market leader for automatic milk foam production as required by the ever-growing popularity toward cappuccino and latte coffees in the USA. As a result of its success, Thermoplan’s name became associated the world over with hot milk foam.

Launching an Automatic Coffee Machine as the Fourth Business

In 1995, making his usual rounds at restaurant fairs, and visiting customers, users of Thermoplan cream whipping and hot milk foaming machines suggested that only coffee was missing from the mix. However, to develop an automatic coffee machine for use in restaurants and hotels would mean a considerable investment. The company founder Domenic Steiner, who ran a profitable business with 21 employees, nevertheless decided to take up this challenge. Recruiting a suitable engineering team, the company worked for 2 years on the project. Steiner invested CHF 2 mio, partially tapping into his pension fund, to avoid having to approach external investors.

The project was not without risk, several professional automated coffee machines were already on the market. The Thermoplan machine differed from the traditional Italian restaurant machines with a barista manually operating the equipment. Branded “Black & White,” the Thermoplan machine was modular in concept, incorporating either or both cold cream whipper and the hot milk foamer. Each machine contained three modules for brewing, for hydraulics, and for steaming, that could be individually exchanged for easy maintenance. The machine, designed for simple 5-minute maintenance stops, produced a perfect espresso at the push of a button in less than 30 s, or more than 120 cups per hour. The first generation of Black & White machines went into production in 1996.

Partnering with Starbucks and Others

Official market introduction took place at the Basel fair in 1997 where Thermoplan, as a newcomer for automatic professional coffee machines, caused quite a stir. Adrian Steiner (not related to founder Steiner), who was later to become CEO of the company, remembered the situation at the Basel Fair exhibition booth:

The Thermoplan team manning the booth was visited during the fair by three guys from Seattle: Peter, Paul, and Larry. They were intrigued by the Thermoplan solution and

informed the team that they were from a coffee chain named Starbucks, a company that was not known to the Thermoplan team at that time! The Starbucks team let the Thermoplan team know that they were looking at some 14 different machine suppliers and required a machine that could deliver both speed and consistency.

After having evaluated several machine suppliers, Starbucks included Thermoplan as one of three suppliers in its 6 months' testing phase and allotted the company a site in Vancouver, Canada. As Adrian Steiner recalled, *This was not the typical "Rössli" in Switzerland*. Over the 6 months' pilot testing phase, Thermoplan managed to constantly adjust and improve its machine, impressing Starbucks with both flexibility and machine performance. This was the time when coffee tastes in the USA began to change and the preference for caffe lattes was just about to take off.

In 2000, Thermoplan signed a long-term, exclusive, global supply contract with Starbucks for all its coffee shops. At that time, Thermoplan had about 35 employees and was a family-owned company, a pioneer in its business, and its organization still unstructured. Everyone at the company got involved in all tasks, depending on where the need was most pressing. Remembering the negotiations with Starbucks, CEO Steiner recalled that the contract terms went on and on over many pages and included considerable restrictions on sales to other customers. For Thermoplan, just two things mattered; the rest was viewed as a "pure legalese." First, the purchasing terms were in CHF and not in USD, eliminating any currency risk. Second, payments were to be made within 10 days after invoicing. This was critical for a company that was sourcing most components from small local suppliers and could thus provide stable financing to them.

Ramping Up Logistics and Production

For the immediate capacity and volume expansion required to meet Starbucks massive orders of thousands of coffee machines annually, Thermoplan benefited from its sourcing strategy. From its inception, the company had relied on local suppliers in Switzerland for components, made to specifications as per Thermoplan engineering designs. Value chain activities at Thermoplan concentrated on purchasing components, assembly of machines, quality assurance, and distribution via distributors since more than 90% of its sales went into exports.

Export sales, other than through partner companies, were supported by three company-owned operations in the key markets of Germany (1998), the USA (2003), and Austria (2011), the latter the result of a takeover of a local distributor. In other countries, Thermoplan operated through a large number of distributors who also performed machine service.

Within 5 years of receiving the Starbucks contract, sales passed CHF 80 mio and employment reached 130. By 2008, sales had doubled again to reach about 150 mio, and employment surpassed 200. Head count of dedicated staff at component supplier

companies was estimated to have surpassed 300. The level of 20,000 annual machines sold was reached in 2013.

Thermoplan constantly adapted its production system. The entire logistics system was fully automated. The production system and machine design, difficult and complex to manage, had to be reengineered for lower costs. For management, it was important to keep assembly and production in Switzerland as quality advantages outweighed potential cost disadvantages. Thermoplan could claim *Swiss quality* and *Swiss Made* for its equipment. The name Thermoplan did not appear on partner machines, just the Swiss cross.

As sales grew, Thermoplan had to continuously enlarge its production capacity. In 2005, the company broke ground for its third factory. In 2014 came the fourth factory expansion and an additional 50 jobs. A major logistics center was planned for 2020. Obtaining the required construction permissions was facilitated by all buildings being concentrated in one community, Weggis, which considerably increased the company's flexibility for growth.

Managing Customer Partnerships

Although Thermoplan sold coffee machines also to other customers, the concentration of 70% of business on a single customer was eventually proven risky. This risk was driven home during the global financial crisis in 2008/2009. Thermoplan had presented its second-generation machine to Starbucks in March of 2008 to the full satisfaction of Starbucks. In October/November of that year, the US coffee chain canceled all orders as the impact of the financial crisis took hold. Initially, due to conservative business management principles, Thermoplan was able to hold on to all employees and know-how as well as work with suppliers to obtain better terms.

In early 2009, when Thermoplan management went to Seattle to discuss this difficult situation, Starbucks founder Howard Schultz attended the meeting and asked rather bluntly which minimum monthly machine order would keep Thermoplan's supply chain viable. Prepared for such a question, Thermoplan named 350 machines per month. Starbucks accepted, and orders proceeded at that rate, to grow later again. Nevertheless, Thermoplan realized that depending for 70% of sales on one single account was far too risky.

Around 2010, Thermoplan began systematically to recruit other long-term partners. The UK-based chain Costa Coffee was developed as a partner for custom-made machines. For Nespresso, a machine for coffee capsules was developed. Partnerships for noncoffee machines were also in development. Observing the difference in collaboration between Starbucks and other partners, such as Nestlé's Nespresso, the company acknowledged the supportive nature of the relationship with Starbucks, contrasting it with the culture of a company such as Nestlé: *Starbucks partnership is great. They are nice people, but they did not make us better. It was us who drove our improvement. Nestlé, by comparison, is pushing us much more to innovation.*

Constant Business Model

From inception, Thermoplan was following a B2B business model supplying professional kitchens, restaurants, and hotels. This model was maintained, and the bulk of its equipment went into professional use, setting the company apart from other espresso machine suppliers, such as Jura, another Swiss company, focusing on espresso machines for in-home use. With Thermoplan's two main lines designed for either 150 cups per day or 500 cups per day environments, the company had clearly professional users in mind.

Today, about 50% of Thermoplan sales were to customers purchasing dedicated custom-made coffee machines. The Starbucks volume was put at 30% of sales. The other half of company sales was made with its standard Black & White model range, now in its fourth generation, distributed to hotels and restaurants in a B2B environment.

Expanding Development and Engineering Process

Thermoplan described the range of hot and cold drinks as its market space for focus, which signaled potentially moving beyond coffee. Although no plans were officially publicized, the company was known to work on tea and chocolate as possible future options.

All engineering and development were based at Thermoplan's location in Weggis, Switzerland. About more than 60 specialists from engineering and science disciplines, an estimated 20% of total employment, were active in development functions. A design Center was maintained in the Canton of Valais where Thermoplan staff regularly met with customers.

The machines were constantly improved since the launch of its B&W Generation One model. In 2007, Thermoplan was the first to integrate a cold milk foamer into its fully automatic coffee machines. In 2011, the company followed up with a catering coffee capsule machine. The telemetry system was introduced in 2014 allowing customers to electronically monitor their machines' performance on their PC via ThermoplanConnect. LatteArtist was introduced in 2018 with its B&W4 generation machines allowing for the creation of artistic designs in the milk foaming phase of a cappuccino or latte.

The Need to Attract Talent

With Thermoplan's growing operations concentrated on a single campus in Weggis on Lake Lucerne, attracting suitable talent was an important task for top management. For normal operations, the company participated fully in the Swiss dual system with about 14 apprentices employed at any time.

For engineering and development positions, Thermoplan relied on regional universities of applied sciences as well as universities such as ETH Zurich. Weggis

was not served by a rail connection; employees were either using local bus services or, in most cases, their private cars to commute. This tended to affect the recruiting radius for talent.

Maintaining Family Ownership and Governance

For almost 40 years, since the company's founding, Domenic Steiner and his wife Esther were the only shareholders of Thermoplan. They followed conservative business practices, funding all expansions without any external financing. Being a family company, they met often and discussed and resolved issues together.

In 2006, Domenic Steiner approached Adrian Steiner (not related) to work with him on a succession plan. Adrian Steiner had joined Thermoplan in 1997, just at the introduction of the first automatic coffee machine. Adrian Steiner had completed an apprenticeship as electrical installer and attended the EMBA program of the University of St. Gallen (HSG). He experienced the enormous growth of Thermoplan from 35 to almost 300 employees firsthand and was familiar with all facets of the company. In 2008, 2 years into the succession planning, company founder Domenic Steiner, now 71 years old, decided to step back.

At the occasion of Adrian Steiner's appointment as CEO of Thermoplan in 2009, the shareholding structure of Thermoplan was also changed. Adrian Steiner could take over 20% of the shares, and the remainder was split between Domenic and Esther Steiner. A binding shareholding contract regulated any future changes or sale. Later on, the family holdings were further subdivided to include the two children of Domenic and Esther Steiner. Both Esther and Domenic Steiner remained on the board, and aside from a lawyer, there were no other external board members.

Except for Adrian Steiner, none of the board members had any operational role in the company. Adrian Steiner, as CEO, reported quarterly to the board, more often, if a major decision, such as a new building or investment, was pending.

Company Profile 31: Komax⁵⁰—World Champion in Wire Processing Machines Helping Customers Manage the Complexity of Wire Processing

Learning from a Teenage Part-Time Job

Max Koch, (1949), at the age of 16, ran a mobile company, “Discotheque Facilities,” in his spare time. The constant rewiring and reassembling of his equipment gave him the idea that an automated process could help with the crimping and reconnecting of the wiring. After completing his studies at the ETH Zurich Koch returned to the Lucerne area and founded Komax in 1975, as a three-man operation in simple premises in Dierikon (LU). This company, 40 years later, had grown into the global market leader for wire crimping machines with sales of CHF 409 mio (2017) and a global workforce of 1850 employees, with its equipment deployed in multiple industries all over the world. Worldwide, the installed base of Komax machines amounted to 25,000.

A Student Project Leading to a Global Business Idea

A graduate of ETH Zurich, Switzerland’s leading engineering school, Max Koch was an inventor and tinkerer at heart. While a student he developed a car-mounted speed-measuring device. To make connecting easier, he developed and built an auxiliary device to cut the many copper cables to the correct length. This device and the experience with it lay at the heart of the Komax business.

In 1976, just one year after starting his company, Koch presented the Komax 20, the world’s first wire cutting and stripping machine. This equipment was far ahead of anything else available on the market and exceeded available alternatives in terms of precision. It was a wire cutting and stripping machine with a stepping motor. A core element of the equipment was the wire cutting blade and its particular geometry and materials to allow for perfection on the wire. The K20 model was followed in 1982 with the K40 model, the world’s first electronically controlled and fully automatic wire crimping machine.

Koch himself described the development of his equipment as stemming from his frequent visits to assembly plants of his customers. Through such visits and close cooperation, customers were communicating their production pain points and Koch could follow up with engineering solutions. Koch emphasized simplicity, with equipment making production simpler, making it easier to use, while at the same time meeting customers’ highest demands in terms of engineering.

⁵⁰This case was written by Jean-Pierre Jeannet (Professor Emeritus Babson College [USA] and IMD Institute [Switzerland]) on the basis of a company interview as well as publicly available information. Copyright©2019.

Modularity of Product Families and Platforms

Komax segment choices evolved over the growth of the company. At the outset, emphasis was on the functions performed of its equipment. Starting with wire stripping, crimping, and cutting and stripping, and moving on to crimping to crimping, twisting, and into harness manufacturing, the company's range of functions performed steadily increased. These functions were offered in either freestanding equipment or as modules that could be plugged into larger systems. In parallel, Komax was offering different product platforms by scaling the desired level of automation, ranging from "essential" to advanced, to "top of the line."

Komax built a large portfolio of equipment for each of the various functions which was constantly undergoing changes, additions, and cancellations. For wire stripping, several different model families with different complexities, from single wire to multiple wires, and different types of stripping technologies, were offered. For wire crimping, different presses were offered with increasing levels of automation and complexity. The cutting and stripping operation and the crimping to crimping function were served with several machine models each. For harness manufacturing, a number of machine models were in the product line, as well as for wire marking. For wire handling, a number of different models were part of the product line. Additional products were offered for quality control, process control, and service.

Concerning platforms or systems, these equipment modules were combined as required and could be engineered to specific customer requirements.

Evolution of Target Market Segments

Although the first Komax equipment was intended for a range of application segments, it was the automotive industry that early on became a major user of Komax equipment. Wiring a car efficiently and to a high-quality standard had always been a challenge. Automotive OEMs increasingly moved this role to wire harness manufacturers who assumed the role of Tier One suppliers.

A compact car "consumed" about 1300 wires, of which 25% were twisted, for a total length of 2000 m. There were about 250 plug housings to connect and about 2300 crimp contacts. Weighing more than 30 kg, the harness cost about CHF 400 to produce. For a full-sized car, the numbers were about 50% to almost twice that of a compact car, and the resulting wire harness, weighing more than 40 kg, had a cost of about CHF 700. For both types of cars, wires cross-section size ranged anywhere from 0.13 mm² to 70 mm² and were made of either copper or aluminum.

The dominant megatrends in the automotive industry contributed to a growth of wiring. Additional safety features required more sensors to be connected. The growing "electrification" of automobiles contributed to a marked increase in cabling per vehicle. Increasing complexity and ever more power supply systems required more automation and thus more cabling. The increasing quality standards demanded

more automated solutions. All of these megatrends tended to increase the market for automated wire processing and equipment, such as the ones produced by Komax.

Finding Segment Focus

Given what wire processing machinery could do for the manufacturers of wire harnesses, it was no surprise that harness manufacturers for the automotive industry were the largest customer group of Komax. In the wire processing segment, the automotive customers accounted for at least half of sales, with the remaining part coming from by a number of other industrial applications, ranging from electronics to telecommunications sectors, and home appliances.

Around 2000, Komax was also looking at other industry applications for growth in the broad market of assembly automation. After some time, two major sectors were targeted, namely the medical sector and the photovoltaic (solar) sector. Both offered some of the technological features Komax applied in its wire processing machinery. While both the medical and the photovoltaic sectors experienced considerable growth early on and exceeded growth in the industrial wire processing sectors, long-term success proved difficult to achieve.

The experience during the financial crisis in 2008/2009 might have contributed to the search for alternatives to the wire processing business and in particular in the automotive sector. Komax experienced a sales decline of as much as 60% from automotive customers during that period, whereas sales in the solar and medical segments remained relatively stable.

In the medical sector, Komax acquired Ismeca, a company active in assembly automation and located in La Chaux-de-Fonds, employing about 120 and with sales of about CHF 42 million. Although there were initially promising results, the medtech business never did take off as expected. Similar developments were registered in the solar business.

In 2013, Komax went through a review of its strategic options leading to a decision to step out of both the solar and medical segments. At that time, wire processing systems accounted for 75% of sales, the rest going for medtech (20%) and solar. Both segments were much lower in profitability than the core wire processing segment. The solar business was sold as part of a management buyout in 2014, and the medical business was sold in 2016 to an Italian buyer.

A Roadmap to Discovering New Growth in Wire Processing

Komax strategy of refocusing on wire processing systems came with a new perspective on its industry that created many growth opportunities. The company analyzed the entire wire harnessing production cycle and the time spent on each step. While important from an efficiency point of view, cutting, stripping, and crimping, the core activities of Komax systems accounted for only 20% of the time needed to create a

wire harness in the automotive industry. Routing and preassembly/taping took up 28 and 25%, respectively.

New insights came from investigating the entire value chain of its customers, going beyond what had been the focus of the initial wire processing systems. The strategy was now clear that Komax wanted to expand the “share of wallet” of its main customers and enter other value chain steps previously left to other companies. Between 2013 and 2017, Komax grew its wire processing business from CHF 254 mio to CHF 409 mio, with more than 80% originating from the automotive sector alone.

Entering Additional Steps of the Value Chain

The strategy to pursue a focus in the known industry segment of wire processing, and automotive applications in particular, was underpinned by a series of acquisitions that brought in adjacent technologies to enlarge the role Komax played in the automation of wire processing and to integrate these additional steps into an enlarged systems offering.

An initial collaboration started with taking a 30% minority stake in SLE Quality Engineering GmbH in 2011 and led to later expanding the stake until assuming full ownership in 2015. SLE, with a staff of 70 in 2011, and located in Grafenau, Germany, was a leading supplier of quality control systems for plug-in contact connections and wire harness production. The company was fully integrated into Komax.

The next step was the acquisition of the German company TSK with deep experience in quality assurance in wire assembly. TSK developed and sold testing systems and adaptation units for testing wire harnesses and other electrical/electronic assemblies, as well as components. TSK systems were primarily used in the automotive supply industry to test the functionality of complex wire assemblies in order to discover any faults in the manufacturing process at an early stage.

Stepping into taping technology came in 2016 with the acquisitions of Ondal Tape Processing and Kabatec, the global market leader in the field of taping technology systems. Located in Burghaun, Germany, Kabatec specialized in taping, bundling, and fixing or holding parts to the wire harness. Serving primarily the automotive industry, the company produced both standard and customized equipment, semi-automatic and fully automatic versions, and had been collaborating with Komax for several years prior to its acquisition. Both Ondal and Kabatec, located only a short distance from each other, were later combined on a single site under the Kabatec name.

The most recent step into new applications for wire processing was the acquisition of Laselec, a Toulouse, France, based company, with a staff of 60 and a subsidiary in the USA. Cooperating with Komax since 2015 when Komax acquired a 20% stake, Laselec developed laser-based solutions for stripping and marking wires as well as intelligent assembly boards for wire harness manufacturing with focus on the aerospace industry. Laselec was a producer of both serial and

customized production equipment. Laselec technology was increasingly applied in the automotive sector also, and through this company, Komax expected better access to the aerospace industry, a heavy user of cables and wiring.

Business Model and Strategy⁵¹

The majority of Komax customers were wire harness manufacturers who processed individual wires, still predominately by hand, into a wire harness that was delivered to the automotive companies (OEMs). Komax offered these companies a wide range of solutions and systems for automated and more efficient processing of wires, as well as for taping and testing the harness. Komax equipment was used in the cutting rooms, at the preassembly stage, and during taping and testing. Komax also supported its customers along the entire value chain, from planning to delivery, with the Komax MES (Manufacturing Execution System). This software automated planning, controlling, monitoring, and analysis of all resources and production processes. This had the effect of optimally deploying machines, materials, and employees with the goal to complete deliveries in line with deadlines at the specified quality levels.

For further development, Komax articulated four key strategic priorities. The company relied on finding solutions along the value chain of its customers which was based on decades of experience and offered customers solutions for the wire harness manufacturing from a single source. The value chain extension strategy was further enhanced with Komax's innovation strategy, its buildup of its global reach, and its push into nonautomotive markets, such as the aerospace industry, where much of the wiring was still done manually.

The acquisitions made over the past years allowed the company to offer its customers end-to-end solutions. The coordination within the entire value chain was further assisted through the Komax MES, a form of production control software for wire processing industry 4.0 launched in collaboration with an external software company.

Raising the Innovation and R&D Intensity

Komax spent 7 to 9% of sales on innovation, research, and development. This intensity was kept up even at the time of the substantial sales downturn experienced during the 2008/2009 financial crisis. Deployment of interdisciplinary development teams was a hallmark of Komax innovation strategy. Teams incorporating different processes and technologies consisting of experts, from marketing, product management, and development engineers, reduced interfaces and lead times for new products.

⁵¹This section heavily relied on the company 2017 Annual Report.

At the end of 2017, Komax employed about 200 in the area of research of development. The majority, about 140, were employed in Switzerland. Beyond the Swiss sites, Komax employed development units in China, Germany, France, Japan, and Singapore. Not included in the above numbers were about 170 development engineers who worked on customer-specific projects. The head count in research and development had been boosted through recent acquisitions of companies with a high proportion of development specialists among their staff. These acquisitions, together with general business expansion, increased the R&D relevant head count by 20% of previous years.

Building a Diversified Global Production Footprint

Komax operated 19 production sites of different size, mandates, and tasks. By far the largest production site was its Swiss plant in Dierikon, subject to a major CHF 70 mio expansion for 2019/2020, and was the center for standard equipment and systems. The sites in Germany focused on customized equipment or systems, such as Grafenau for solutions and client-specific systems, Burghaun for taping, and Porta Westfalica for testing equipment. The site in Hungary concentrated on development and production of solutions of high voltage cables for electric mobility. The operation in Japan was dedicated to benchtop machines, and China operations were mainly for the Asian market.

The other production points were for engineering and assembly of testing systems for the local market. These sites were located in a number of countries with a concentration of wire production, such as Hungary, Turkey, Bulgaria, Rumania, Mexico, Brazil, Tunisia, and Morocco.

Building a Sales Footprint to Cover Key Markets

Komax sales reflected the worldwide distribution of wire harness producers, particularly those devoted to the automotive industry. Only about 2% of Komax Group sales were to Swiss customers. Europe accounted for the largest share with about 50%, followed by Asia/Pacific with 20, the Americas also with 20, and Africa with 10%.

Sales to global key accounts were coordinated from the Dierikon head office in Switzerland. Customers were offered a single point of contact for their business with Komax.

Each segment was organized as an SBU. The company required each segment to be self-supporting and profitable in terms of RONCE, the financial measurement metric applied at Komax. Automotive was a core segment, with others organized around aerospace and telecom.

Komax also used specific acquisitions to expand its sales footprint. The acquisitions in Singapore, Japan, and Eastern Europe all were aimed at geographic market entry.

Talent Sourcing

For its talent, particularly in Switzerland, Komax undertook considerable efforts to recruit employees on a regional basis. Easy access to private or public transportation helped to attract employees beyond the local region and tap into the market for talent in the Cantons of Zurich, Zug, or Aargau. The company found that being the market leader and experiencing considerable growth was an important aspect to attract employees. For many areas, employees with a combination of technical and commercial or business background were of particular interest to Komax, such as managerial talent who had earned an EMBA on top of initial technical qualifications.

Of particular note was the reliance on the Swiss dual system as a source for future employees. Komax had almost 50 apprentices in training in Switzerland, and another 35 in Germany where the dual system was also popular. Apprenticeships were offered in areas such as polymechanics, engineering design, automation, IT, and commercial areas. It was important for Komax to be able to hold on to promising staff members once they completed their apprenticeship.

Governance and Ownership Experience

Started as a single proprietorship in 1975, Komax became a limited company (AG) just three years later. In 1996, founder Max Koch, at the age of 47, sold 80% of his shares for CHF 100 mio to management and a private equity company as part of an MBO. At that time, Komax had sales of about CHF 120 mio and a workforce of 365. Just one year later, the company went public with a listing on the Swiss exchange. The company founder, Max Koch, remained the largest single shareholder with a holding of about 5%. Shares were widely held, and the free float amounted to more than 90%. Shareholders were mostly Swiss investors.⁵²

Through its stock market listing, Komax had access to additional capital if needed. Over its history, the company could rely largely on its self-generated cash flow and used external debt financing through banks for only a small part of its capital needs. Its financial performance, measured in RONCE, of 25% and with an EBIT of more than CHF 50 mio, allowed for a constant investment of about CHF 20–25 mio and a targeted dividend payout ratio of 50–60% of earnings after tax.

Running a private company allows for more long-term thinking than a public one, but only if all owners are on the same page. As a public firm listed on the stock exchange, the required transparency and visibility leads to higher and more short-term pressure on performance (Beat Kälin, Chairman).

⁵²Source: Bilanz Magazin, December 1, 1997, p. 170.

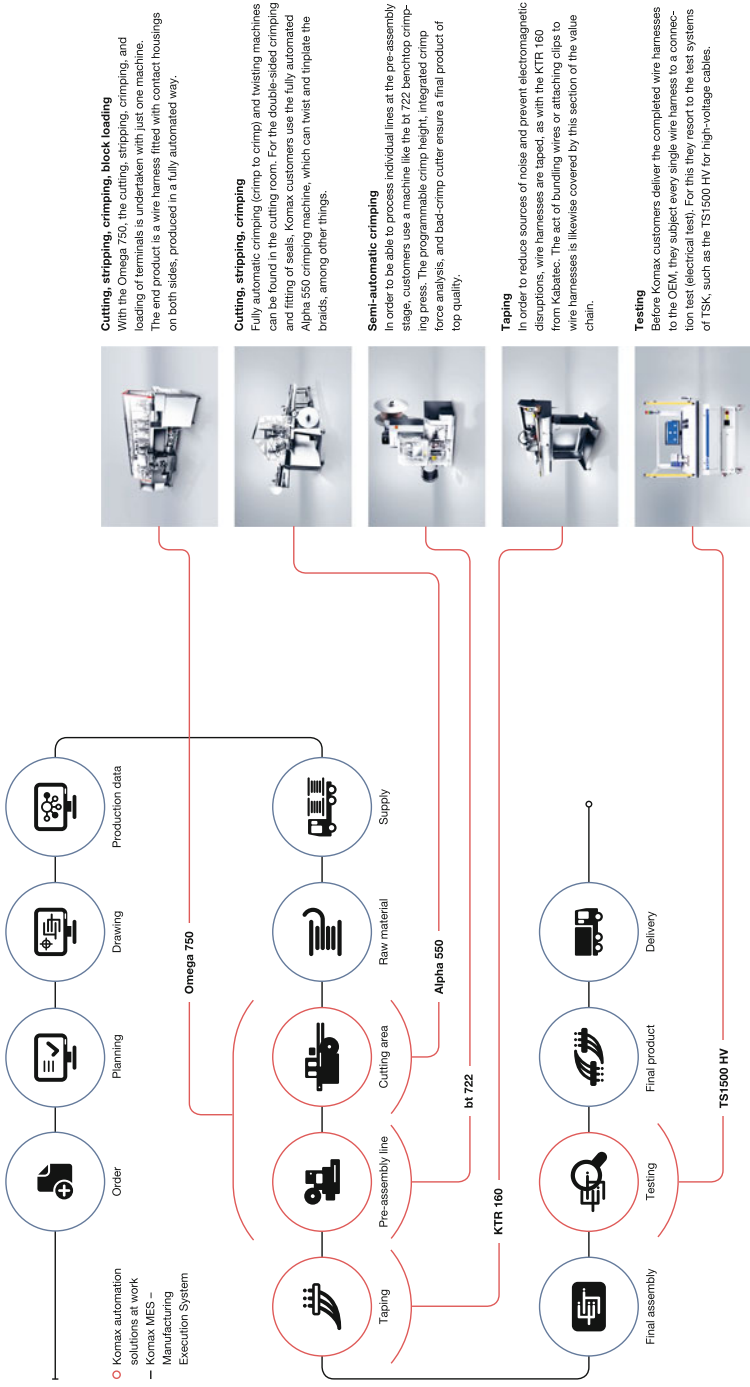

Cutting, stripping, crimping, block loading
 With the Omega 750, the cutting, stripping, crimping, and loading of terminals is undertaken with just one machine. The end product is a wire harness fitted with contact housings on both sides, produced in a fully automated way.



Cutting, stripping, crimping
 Fully automatic crimping (crimp to crimp) and twisting machines can be found in the cutting room. For the double-sided crimping and fitting of seals, Komax customers use the fully automated Alpha 550 crimping machine, which can twist and flirplate the braids, among other things.



Semi-automatic crimping
 In order to be able to process individual lines at the pre-assembly stage, customers use a machine like the bt 722 benchtop crimping press. The programmable crimp height, integrated crimp force analysis, and bed-crimp cutter ensure a final product of top quality.



Taping
 In order to reduce sources of noise and prevent electromagnetic disruptions, wire harnesses are taped, as with the KTR 160 from Kabatec. The act of bundling wires or attaching clips to wire harnesses is likewise covered by this section of the value chain.



Testing
 Before Komax customers deliver the completed wire harnesses to the OEM, they subject every single wire harness to a connection test (electrical test). For this they resort to the test systems of TSK, such as the TS1500 HV for high-voltage cables.



Exhibit 26.27 Komax product line

Company Profile 32: Mikrop⁵³—Niche Player in High Precision Micro-optics. Developing and Producing Miniaturized Optical Systems

Becoming a Niche Player for Optical Systems and Components

Mikrop was an international technology leader in high precision optics located in Wittenbach, near St. Gallen. The company product portfolio included optic design, development, production, assembly, and function checking of high precision micro-optics, all offered as a one-stop shop. Mikrop's main markets were medical technology, automotive, machine vision, telecommunications, research, and astronomy. However, the main focus was on medical technology, specifically endoscopy applications, which accounted for a majority of company revenues. The most important geographic markets were Europe and the USA, generating 70% and 25% of revenues, respectively. Asia showed the highest growth potential for the coming years. The company generated annual sales revenues of around CHF 17 mio and employed 160 people across locations in Switzerland, Germany, and Serbia.

Two Employees Started a Company by Leaving Their Former Employer

In February 1981, Gerhard Machleidt and Erhart Müller, both former employees at another optics company in St. Gallen, decided to start their own business by founding Mikrop. The two entrepreneurs hit the ground running as they were able to take some clients into their newly established company. This helped to immediately generate revenues after launching their business venture.

Soon after, Mikrop was setting standards in the area of miniaturization for optical components and integrated solutions for optical microcomponents with diameters from 0.3 mm to 15 mm, as well as customer-specific microobjective lenses and microsystems. The company quickly positioned itself as a leading provider of specialized micro-optics for industrial image processing and medical technology applications.

Early on, the company started developing its own equipment to produce optical components. State-of-the-art measurement instruments were used to meet the highest levels of quality requirements. In 1998, following a period of strong growth, Mikrop moved to new facilities in Wittenbach near St. Gallen. The move to its new location doubled the production surface.

⁵³This profile was written by Thierry Volery (Professor Zurich University of Applied Sciences and Visiting Professor University of St. Gallen) and Heiko Bergmann (Adjunct Professor of Entrepreneurship University of St. Gallen) on the basis of a company interview and publicly available information. Copyright©2019.

German Investment Holding Acquired Mikrop

In 2000, Mikrop was acquired by INDUS, a German investment holding, as part of the company founders' succession plan. INDUS typically invested in medium-sized manufacturing enterprises located in Germany and Switzerland. Following this acquisition, the two founders stayed on, and Gerhard Machleidt remained CEO.

In 2004, Klaus Mlejnek took over the CEO position from Gerhard Machleidt. At the same time, Mikrop expanded into optics design and fitting of optomechanical components, providing optical calculation and assembly of optomechanics. In 2015, Markus Bormann was appointed CEO. Bormann, a graduate in mechanical engineering from the ETH in Zurich, had previously been CEO of Plaston and SWAP Sachsen GmbH.

Focusing on Process Innovation

At Mikrop, process innovation was important because of the necessity to develop and build machines and tools for production in-house. In fact, there were no suppliers for machines that could readily produce optics with a diameter of less than 10 mm, and therefore, the company had to develop its own production equipment. According to CEO Markus Bormann, Mikrop developed production processes that allowed the company to work at higher levels of precision than most of its competitors.

The development of these specific production assets was based on the vision of the two founders. Some of the machines developed in 1980s were still in use today. *One of the worldwide leaders in optics and optoelectronics was interested in buying one of our centering machines*, recalled Wolfgang Braxmaier, head of sales & development. However, Mikrop, wanting to keep the knowledge in-house, declined the offer.

Mikrop did not operate a formal R&D department. According to Braxmaier, the company did not conduct any basic research but instead developed products and solutions upon client requests. Working closely in project teams with its customers, Mikrop developed new products on a regular basis. On occasions, Mikrop also developed new product lines on its own initiative.

Developing a Global Sales Footprint

From the beginning, Mikrop had developed an international customer base. The company regularly participated in trade shows abroad to tap into the global market for optics products. In recent years, for example, Mikrop participated in World BiOS & Photonics West in San Francisco, World Medtech Forum in Luzern, Optatec in Frankfurt, and Compamed in Düsseldorf. Sometimes, Mikrop shared a booth with local optics manufacturers, such as Zünd Precision Optics, in order to minimize costs and increase contacts at trade fairs.

Mikrop served a small number of key customers and generated about 50% of its revenues with three customers alone. There were very close, and continuous, interactions with these customers through key account managers. Through this process, the company had always been close to its market and was able to anticipate new developments, such as the trend toward miniaturization.

Establishing an International Production Footprint

Because of the high cost for production in Switzerland, Mikrop decided in 2007 to open a second production site in Kac, Serbia. The Serbian location was mainly used to produce standardized products.

About 75 employees were employed at this production site. The company had been able to transfer specific technical knowledge in optics production, to the effect that many processing steps took place in parallel in Serbia and in Switzerland. This allowed Mikrop to offer attractive pricing in line with market expectation. Shipping and final inspection were always undertaken at Mikrop's main production site in Switzerland, thus guaranteeing high *Swiss quality* standards customers had come to expect.

In 2016, Mikrop acquired in-situ GmbH, a small business located in Sauerlach, Germany. This acquisition gave Mikrop access to expertise in digital image processing and 3D measurement technology, two areas of increasing importance in the optics industry. The main goal of the acquisition was to get immediate access to digital image processing, as well as 2D and 3D measurement expertise, which would otherwise have taken Mikrop as much as a decade to develop.

Building A Niche in Micro-optics

Mikrop focused on high-end optics with diameters ranging between 3 mm and 15 mm, and it was widely regarded as a top-quality manufacturer in the industry. According to Wolfgang Braxmaier, head of development and sales, there were only a handful of companies worldwide that could offer microlenses of similar quality.

Over time, Mikrop developed organizational routines to offer customers seamless service from initial inquiry up to the point of volume production. Main steps of the value chain process included creation of complete specifications together with customers, optics and mechanical design, project management, technological coordination with other production partners, functionality and quality checks with state-of-the-art tolerance analyses, and, finally, series production using functional and cost optimization.

Close relationships with key customers often led to product codevelopment. Because of the importance of process knowledge in micro-optics and the need for specific equipment, potential new entrants faced high entry barriers into Mikrop's core market. Small market size, small batch sizes, and the need for flexibility all acted as deterrents for bigger players to enter the market.

Mikrop's focus on a global niche was at the center of its strategy. Mikrop's owner-managers realized that the strength of the company was in optics with very small diameters and early on realized that it did not make sense to enter other, less specialized segments because of fierce competition by larger players in these markets. By doing so, the company focused on high-quality products paving the way to a position as one of the most sophisticated suppliers of high-precision optics globally. Due to the relatively small size of Mikrop's niche, bigger players were reluctant to enter its market.

The Challenge of Recruiting and Retaining Talent

Recruiting adequately trained employees for its operations was one of the challenges faced by the company. However, thanks to the regional proximity to other optics companies, there was a pool of relevant talent in Eastern Switzerland. These companies were located in the region of St. Gallen and in the Rhine Valley, training their own apprentices in precision optics. Upon completion of their apprenticeship, some of those highly qualified workers often remained with the company, while others would join other optics manufacturers in the region.

The company experienced low staff fluctuation. According to CEO Markus Bormann, employees were generally highly loyal and stayed with the company over a long period of time. Mikrop also employed staff who originally came from former Yugoslavia. Some of them completed an apprenticeship in precision optics, while others acquired manufacturing and assembly skills over several months through on-the-job training.

Practicing A Strong Team Culture

With a large number of Mikrop employees coming from abroad, the company demonstrated a culture of diversity. In addition to this openness, the corporate culture reflected traditional Swiss values, such as quality and reliability. Appreciative customers often commented on these values.

A number of tasks were completed in small teams, typically project teams for new product development, and in production teams. This approach was thought to foster team cohesion. The collaborative working environment nurtured fast and efficient decision-making processes. The small size of the company and team approach led every employee to try to contribute to the success of the organization.

Management promoted open communication and encouraged employees to leave behind prescribed ways of thinking and to accept the challenges and uncertainties of pursuing new ideas. According to CEO Markus Bormann, an entrepreneurial leader should signal to employees that entrepreneurial acting was desirable, and to reshape employees' perceptions of their capabilities by involving them in developing new ideas, building confidence and commitment toward implementing innovative ideas.

Low staff turnover allowed the company to reap substantial savings on recruiting and training costs for new staff, leading to organizational stability and retention of expertise and tacit knowledge.

Leveraging the Swiss Business Environment

CEO Markus Bormann regarded the business conditions in Switzerland as highly conducive for the company's development. High-quality education, relatively low and transparent taxes, political stability, and government efficiency all were regarded as major advantages.

Optics and photonics companies in the region had developed a tradition of collaboration in the field of education and training, particularly for apprenticeships. In addition, the companies in the optics cluster collaborated on a range of projects funded by Innosuisse with the Institute for Production Metrology, Materials and Optics at the local University of Applied Sciences (NTB Buchs). In the past, companies had also “lent” or “borrowed” staff from each other to optimize production capacity.

The relatively high cost for conducting business in Switzerland was regarded as a disadvantage. Labor and construction costs, for example, were significantly higher than in other European countries. In addition, Mikrop was hit hard by the “Swiss Franc Shock” of 2015. There has been an extraordinary phase of appreciation of the Swiss currency. Companies primarily producing in Switzerland could only benefit to a limited extent from lower purchasing prices abroad. To counter the high-cost pressure in Switzerland, Mikrop offshored part of its production to Serbia for standardized and basic components.

Corporate Governance at Mikrop

Until acquired by INDUS in 2000, Mikrop was fully owned by the two founders. Both remained with the company after the sale and senior management remained in place as well.

According to CEO Bormann, INDUS followed management by objectives principles, granting Mikrop a high level of autonomy provided key performance objectives were met. Furthermore, INDUS supported Mikrop in terms of financing, enabling the acquisition, of in-situ GmbH, as well as the new production facility in Serbia. As a result, Mikrop remained strategically as well as operationally independent while leveraging the financial resources of the parent company. This arrangement combined the advantages of running a lean SME with a financially strong corporation.

Likewise, Mikrop gave the newly acquired company in-situ GmbH considerable autonomy. The two companies collaborated on a project basis but remained operationally independent. This perceived independence provided a sense of “felt ownership,” fostering innovative attitudes and behavior.

Company Profile 33: Datamars SA⁵⁴—A Pioneer in the Application of RFID. Tagging Laundry and Animals

Ticino, the southernmost canton of Switzerland, known for Italian flair, agreeable weather, and natural beauty with mountain views and picturesque lakes, was also the home to a fast-growing technology company, Datamars. Founded in 1988 as a joint venture between the companies Datalogic and Audemars, it had been headquartered in the Ticino since its foundation. The company developed, designed, and manufactured state-of-the-art RFID (Radio-Frequency Identification) solutions for animals and textile identification, becoming global leader for companion animals, livestock, and textile identification. Including recent acquisitions, Datamars in 2018 employed more than 1500 worldwide, maintaining production sites in Thailand, USA, Slovakia, Spain, Australia, and New Zealand, and operated more than 20 offices across Europe, Asia, and the Americas.⁵⁵

Developing RFID Identification for Pets and Laundries

In 1988, the Italian barcode-specialist Datalogic and the Swiss watch component manufacturer Audemars joined forces to start Datamars in Bedano (near Lugano), Switzerland. The company name reflected the names of the two founding companies. Founder and first CEO of Datamars, Parvis Hassan-Zade, had previously worked in the watch industry. While Hassan-Zade strongly believed in the potential of RFID for the identification of animals and laundry, he encountered initial difficulties to convince investors to inject capital. He started Datamars with a small team of four. The company quickly established itself as a leader for RFID solutions in the growing companion animal and textile identification markets.

Although Datamars had not invented the RFID-technology, it developed innovative and suitable applications for its target industries. Right from the beginning, Datamars followed the strategy of offering complete identification systems, including transponders, readers, and antennas, rather than individual components only. The company started with applications for animal identification, textile identification, and in the early days also for waste container identification, later abandoned. All system parts were produced in-house for best fit and to guarantee maximum performance.

⁵⁴This case was written by Heiko Bergmann (Adjunct Professor of University of St. Gallen) on the basis of a company interview as well as publicly available information. Copyright©2019.

⁵⁵Datamars, as a privately held company, does not divulge any financial information. As a result, sales were estimated by the research team at CHF 300 mio for 2018, with substantial growth recorded following later acquisitions not fully reflected in the profile.

Mikrop Exhibit on Product Line



Spherical optical lenses

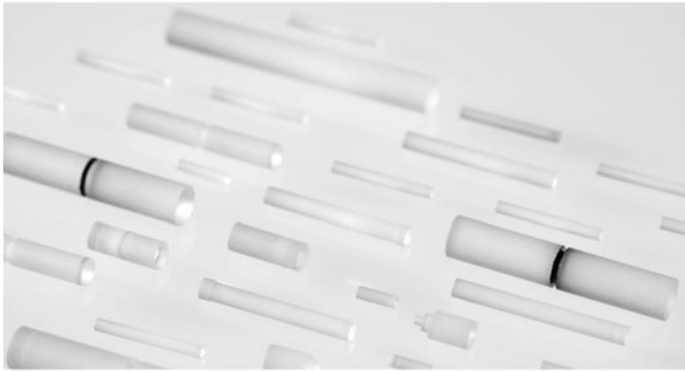

Rod lenses

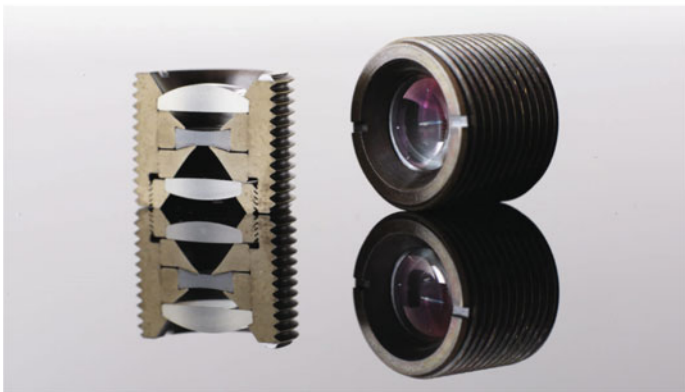

Objective lenses

Exhibit 26.28 Mikrop product line

Starting Out in the Laundry Sector

After a management buyout in 1991 involving two private equity funds, the company expanded rapidly. Ever since, majority ownership of Datamars had been in the hands of private equity investors. Initially, growth came primarily from sales for textile identification. By 1990, Datamars had invented the Laundry Chip™, the world's first RFID transponder specifically designed for the industrial laundry sector to withstand undamaged the harsh environments of washing, ironing, and logistics cycles. In 1991, a first identification system was sold to a laundry service company in Scandinavia.

Real-life testing was a major problem when producing laundry transponders. To complete essential quality tests successfully, chips needed to be washed and dried a hundred times or more, sometimes taking months. To avoid a long waiting period before releasing each new production batch, Datamars developed a wash-cycle test simulating 100 complete wash cycles in a single day. This test was applied to every single production batch and enabled the company to issue a guarantee of high quality. By 2000, more than 25 million transponders had been sold, allowing Datamars systems to be installed in more than 200 laundries, growing to more than 10,000 installations and more than 150 million textile tags in use by 2018. The most recent reading portals were able to read up to 500 pieces on a single cart at regular walking pace.

Growing in the Companion Animal Market

During its first 15 years, Datamars generated a majority of sales with the production of transponders and readers for laundry recognition. The recognition of animals became more important in the following years. The advantages of implanting passive RFID microchips under the skin of an animal became increasingly apparent at the turn of the millennium as the high number of pets in the USA and in Europe encouraged the founder's enthusiasm for this market. The World Canine Organization came out in support of the electronic identification system in 1997. One year later, Italy conducted the biggest tender for transponders in Europe, won by Datamars for 500,000 dogs to be identified electronically.

As a pioneer in electronic identification for companion animals from house pets to horses, Datamars contributed to the creation of the international animal identification standards (ISO standards 11784 and 11785), as well as to the worldwide promotion of these standards. Not having its own distribution network, Datamars signed OEM agreements with major veterinary medicine companies, such as Bayer, Novartis, and Virbac, who marketed the products under their own label to veterinarians, adding "Manufactured by Datamars." For Switzerland, Lyssach-based Provet took over representation. In 2003/04, Datamars established its first sales subsidiary in the USA. Employment in Ticino reached 65. Early on, cost- and labor-intensive production of most components had been outsourced to Thailand, where 60 employees worked for Datamars.

The EU required a chip, or tattoo, for pets to enter in October 2004. Spain, France, and Italy also introduced regulations for identification by chip. Switzerland, as of 2007, required all dogs to be marked and registered by chip. These regulatory changes caused annual sales of Datamars to jump from CHF 22 mio to 27 mio.

Changing Ownership and Management

In 2005, a consortium of investors led by Iris Capital and Invision, and also involving Cornerstone Capital and Universal Capital Partners, invested EUR 12 mio to acquire a majority stake in Datamars. With founder Parvis Hassan-Zade approaching retirement at the age of 63, the new investors demanded new leadership, appointing a new management team headed by Klaus Ackerstaff (CEO) and Daniele Della Libera (COO). The new investors attached great importance to international expansion, especially in the USA, demanding growth rates of 30% annually over several years. With innovative products and increased international sales representations, management was confident to be able to deliver.

Surviving Litigation in the USA

One year after the new management was installed at Datamars, the company was hit by disaster. Years earlier, Datamars had entered the US market with its animal identification products. Animal identification was covered by a number of patents with two players in the USA using their own protocol to identify animals, preventing anybody with cross patents to enter the market. Datamars wanted to introduce ISO standards as otherwise a dog traveling would not be identifiable globally. Datamars became the target of a lawsuit of competitors claiming patent infringement. Unexpectedly, the lawsuit was lost and Datamars was required to pay in excess of USD 6 mio in fines. Datamars, technically insolvent, had to find new capital to fund the litigation. From one moment to the next, the new management had to focus on raising additional capital instead of on marketing products. As business continued to run well with the company's products showing good prospects, investors and bank lenders continued to support Datamars. Additional capital was provided by an external Swiss investor and some new shareholders, overcoming that severe crisis in the end.

Concentrating Electronic Production in Thailand

Although the company did not generate substantial profits during the litigation crisis, it succeeded in the market. The considerable legal costs caused financial distress, forcing the company to look for other ways to become more successful economically. Management believed in producing in a low-cost country to stay competitive in the long run. In response, Datamars decided to open a factory in Lamphun, Thailand, making it its single production site for all electronic components. All

third-party production in Asia, as well as remaining production in Switzerland, were moved to the new site in Thailand, involving layoffs in Switzerland. Reducing production costs, insourcing everything, achieving economies of scale, and capturing value added from production became the Datamars strategy. Datamars was subsequently able to “fight on price and for market share,” squeezing out smaller players.

Production in Thailand had initially started in 2007 with a workforce of 20. By 2018, employment amounted to 560, becoming the largest single location of Datamars. Production was partly based on standard, partly on specialized equipment developed and refined in-house. In addition, production involved an element of implicit knowledge not easily copied. With its production in Asia permanently established, Datamars became the only vertically integrated company designing and producing all key RFID components for solutions in companion animals and textile identification.

Reentering Livestock Identification Sector

By 2008, Datamars employed more than 160 globally with offices in Europe, Asia, and the Americas, the litigation in the USA was settled, and the plant in Thailand was up and running. Management convinced the board that Datamars needed to move beyond its “pet and textile sectors only” strategy, suggesting a reentry into the livestock identification market, the technology being similar.

To identify farm animals, externally attached microchips, such as RFID ear tags or bar-coded tags, were commonly used. The livestock market was much larger than Datamars’ other segments, offering more potential for growth than the current two market niches. In addition, further regulatory changes fostered growth of this market, with the EU making electronic identification mandatory for sheep and goats as well, starting in 2010.

In 2009, shareholders, initially reluctant to enter into new and risky projects following the litigation experience in the USA, gave green light for Datamars to purchase a majority of the assets of Runitag, a Spanish livestock identification company, including patents, products, and production lines. Founded in 1989, Runitag had successfully sold livestock identification systems internationally and built a large network of distribution partners.

The acquisition of Runitag was followed by three other acquisitions in the livestock identification market, namely Temple Tag in 2012, a recognized animal identification company based in Texas; Zee Tag in 2014, a global leader in animal identification based in New Zealand with operations in the USA and Australasia; and Felixcan in 2016, a European companion animal identification business. By 2017, Datamars had acquired more than a 25% share in this market, becoming number two worldwide behind Allflex of France. Datamars remained number one in textile and pet identification markets, with all segments growing.

Integrating the acquisitions, Datamars always followed the same strategy. Apart from Datamars’ largest competitor, Allflex, all the other companies in the industry had outsourced production. Datamars streamlined its portfolio, unified it wherever

possible, and insourced production, realizing synergies. Aiming to create “barriers” through volume production to ensure economies of scale and creating a local presence in important markets, Datamars was able to be close to customers and to control distribution of its products. Della Libera summarized Datamars’ strategy as follows: *We always apply the same logic: cost leadership on one hand, focus on the customer on the other hand (. . .). There is no magic, (. . .) but you need to do it this way. You need to be consistent.*

Acquisitions made by Datamars would not have been possible without the financial backing by its principal lenders, especially its private equity investor Columna Capital (since 2011). Together with management, it was instrumental for the development of the growth strategy and supported it financially. In 2017, Datamars further strengthened its investor base with Caisse de Dépôt et Placement du Québec, a large long-term institutional investor from Canada, becoming the company’s largest shareholder, investing alongside Datamars’ senior management and Columna Capital.

Restructuring Production Footprint

Datamars’ move into the livestock industry also triggered the insourcing of the injection molding process. Initially, Datamars had not considered this a key production step. In livestock management, a substantial part of identification still involved ear tags with RFID chips molded in plastic material, accounting for a high proportion of value added. In line with this fact, Datamars established three global sites for plastic injection molding, creating sites in Texas, Thailand, and a new plant in Slovakia. Because molded parts, such as ear tags, were bulkier than electronic components, Datamars assigned production to three different locations, to manage shipping costs. Implantable identifiers were assembled in Spain, increasing the number of sites to four in 2017. Local finishing sites in all key markets customized livestock tags according to national requirements, shipping to customers within 24 h.

Central functions, such as development, financial services, and central management, remained in Switzerland, with a staff of about 80. Engineering talent being in high demand in Switzerland, finding the right staff posed a big challenge for the head office in Switzerland. Many engineers working for the company commuted daily from nearby Italy, attracted by the company’s dynamics, internationality, and flat hierarchies. Rapid growth and constantly integrating new companies into the group required adaptability and created a certain level of stress for employees, something not everybody was willing to accept.

Targeting New Segments

In 2018, Datamars began to expand into segments beyond identification. Datamars acquired Simcro, a New Zealand-based world leader in animal health delivery systems, such as injectors or oral applicators. Later that year, Datamars acquired a major stake in New Zealand’s Tru-Test, a global leader in advanced livestock

management, offering weighing and identification systems and portable milk metering solutions. The newly acquired companies operated production facilities in Australia and New Zealand. By combining livestock identification expertise with animal management tools, Datamars hoped to deliver integrated systems promoting animal health, enhancing overall livestock business management and ultimately improving precision protein production for its customers.

Beyond RFID, a passive technology operating without batteries, Datamars considered active tags with batteries as the next big technology step and started to work on developing such solutions. Using active tags, reading health status and other information of the animals would become possible. Although the focus was currently on products based on the core competences in electronics, assembly, and molding, utilizing existing resources and new products would still be targeted at existing Datamars customers. With its extensive network for distributing ear tags, the goal was to offer farmers an enhanced range of products, leveraging synergies. After 30 years of continued growth, the company constantly scanned the horizon for new developments shaping the future.

Company Profile 34: Medartis AG⁵⁶—From Spin-Off to Global Player in Fixation for CMF and Small Bone Extremities

Created from Forced Spin-Off

The visitor looking for Medartis will have to go to the far corner of the city of Basel, to the point where the borders of Switzerland, Germany, and France join. There, called the Stücki Business Park, a large multistoried building, Medartis occupied several floors on the northern end of the structure.

Medartis, founded in 1997 as a spin-off from Straumann Dental with a small team of half a dozen employees, focused on manufacturing implants for surgical fixation of bone fractures and osteotomies, including radius fixation, distal radius, arthrodesis systems, wrist and footplates, and other medical instruments. The company's avowed goal was to become a major player in small bone implants.

Thomas Straumann, the company founder, originally intended this small business to provide his larger Straumann Dental business with a second strategic leg for future growth. When Straumann Dental was planning an IPO in 1997, the financial community preferred a single focus on dental applications and convinced Straumann to spin off the small team into Medartis. To lead this team, Thomas Straumann pulled in Willi Miesch whom he had known since their apprenticeship together as polymechanics at Straumann Institute.

⁵⁶This profile was written by Jean-Pierre Jeannet (Professor Emeritus Babson College [USA] and IMD Institute [Switzerland]) on the basis of a company interview as well as publicly available information. Copyright©2019.

Starting with zero sales in 1997, the company grew to sales of approximately CHF 120 mio (2018) and 550 employees, half of which worked at its international sales subsidiaries. The company, combining production and administration functions on a single site in Basel, specialized in fixation devices made from titanium materials for the treatment of bone trauma in CMF (cranio-maxillofacial), as well as the upper and lower extremities. In 2018, just 20 years after its creation, Medartis went public on the Swiss stock exchange.

The Technology DNA of Medartis

Medartis and its product portfolio were not created out of thin air. Professor Reinhard Straumann, grandfather of company founder Thomas Straumann, founded the Straumann Institute in 1954, was known as the creator of the world's best watch spring, partially based on his superior understanding of metallurgy. In 1960, Reinhard Straumann came in contact with the founders of the AO, a group of surgeons developing metal implants for osteosynthesis in the treatment of bone trauma. Under the direction of his son Fritz, the Institute Straumann began the coproduction of metal implants for the AO organization and was one of first two, later three, licensed producers of these implants. The Straumann Institute also played a pivotal role in the determination, improvement, and specification of stainless steel suitable for the use in the human body.

When Fritz Straumann unexpectedly died in 1988, the Straumann family decided to spin out its AO implant business Stratec Medical under the leadership of its management. The proceeds allowed each of the Straumann family members to pursue their own projects. His son Thomas Straumann retained a small group of about 20 specialists that had started to develop applications from their technology and manufacturing experience for dental implants under his father. This group became Straumann Dental in 1990, a company that Thomas Straumann grew and took public in 1997 when sales amounted to about CHF 100 mio. Today, Straumann Dental was the global leader in dental implants, employed more than 5000 worldwide, and had sales of close to CHF 1.4 billion.

The decision to return to the osteosynthesis roots of the Straumann family was triggered by a possibility to acquire a small specialist firm in Freiburg, Germany, specializing in implants for osteosynthesis for maxillofacial applications. Thomas Straumann's idea was to turn this eventually into a second strategic leg for the Straumann Dental company.

When Thomas Straumann decided in 1997 to IPO Straumann Dental, and on advice of his bankers, he separated the small team working on bone trauma implants into a separate business. This new company, Medartis,⁵⁷ could thus benefit from the long heritage the Straumann family companies had accumulated in designing,

⁵⁷The name Medartis stems from a Latin term and translates roughly as "medical arts."

machining, developing, and marketing medical implants. Through this split, two different entities emerged, both with a singular focus.

Creating Medartis as Another Start-Up

The start of Medartis represented the second start-up by Thomas Straumann, after the successful launch of Straumann Dental. From the beginning, Straumann called on his old apprenticeship friend, Willy Miesch, who also had completed his apprenticeship as polymechnic at the Straumann institute, and entrusted him with the operational leadership of the venture.

Willy Miesch, after completing his apprenticeship at Straumann Institute, took up a chance to spend a year in the USA and then returned into the Straumann medical business producing implants for osteosynthesis under the AO license. Miesch followed the former Straumann medical business when spun off as Stratec Medical and assumed several positions in production operations, even heading a plant in the Ticino. He left the medical business to become technical head of Villiger Bicycle company, learned about different production processes, and completed a diploma in operations technology. He recalled a phone call one day in 1997 from Thomas Straumann, inviting him to join the new operation he planned to start up, and become its operational manager. The purpose of the new business was to reenter the field of osteosynthesis for craniomaxillofacial surgery turning into the Medartis operation.

Leveraging the Singular Focus and Experience of the Company Founders

Both Thomas Straumann, founder and board chairman, and Willi Miesch, Medartis operational manager and CEO, had deep roots in the production process of titanium-based medical implants for osteosynthesis.

Thomas Straumann became early on involved in the dental implant research carried out at the Straumann Institute. When the osteosynthesis business was sold following the death of Fritz Straumann in 1988, Thomas retained the dental group then operating under Straumann Institute, which was to become the nucleus of Straumann Dental.

Building a Growing Product Portfolio

Medartis, through its subsidiaries, manufactured implants for the surgical fixation of bone fractures and osteotomies. Medartis Holding provided radius fixation, distal radius, arthrodesis systems, wrist and footplates, and other medical instruments. Medartis served customers worldwide.

When Medartis started out first within Straumann Dental (1997) and formally as a separate company (1998), the emphasis was on development of plates and screw

systems that could be used in CMF applications, such as for the mandible, mid-face, and cranium. These products, branded MODUS, were first presented at a medical show in Germany in 2000.

In 2004, Medartis introduced its APTUS product line for hand and distal radius indications. The APTUS system also saw the launch of several important technologies, such as the TriLock[®] system, HexaDrive[®], and SpeedTip[®], which were decisive in the market penetration of orthopedic trauma indications for lower and upper extremities. Expansion for feet indications was the latest APTUS line extensions.

The original MODUS line accounted for about 15% of sales. Sales for the APTUS product line were strongest for the hand, wrist, and elbow indications accounting for about 70% of sales. The most recent expansion of APTUS for feet indications made up about 15% of sales. The company indicated that shoulder applications were planned for 2019 adding to the strength of its upper extremities line.

Significant Intellectual Property Protection

Medartis built up about 20 patent families, either granted or filed, and more than 100 national patents, granted or filed. Patents covered the main markets of Europe, USA, Japan, China, and Brazil.

The most important patent families concerned Trilock[®], HexaDrive[®], and SpeedTip[®]. All contributed substantially to the competitiveness of the Medartis product lines. TriLock[®] was described as a new generation of multidirectional and angular stable fixation system. This system allowed locking screws to be fixed in the plate within a selectable range. Medartis HexaDrive[®] and SpeedTip[®] screws were designed for more efficient insertion into the bone. Allowing for movement of screws after the placing of plates represented a unique flexibility for the surgeon.

The entire product line was modular in design and use, allowing the many screw designs to be combined with the numerous plates for implantation. The MODUS system consisted of about 40 different plate designs and types in three different thicknesses, as well as many different screws, all color-coded for effective use in surgery. The APTUS system for wrists alone included more than 60 different plate types with the corresponding screws, all designed as a modular family of products. In total, the Medartis product line consisted of about 4000 SKUs.

Running a Multifaceted Business Model

The Medartis business model ran along three different, but coordinated tracks involving professional training, placement of surgical sets in hospitals, and billing for the actual use of implants after surgery.

Through the partnership with the International Bone Research Association (IBRA), formed in 2004 in Zurich by 18 clinicians, a large number of educational

programs and training programs were offered that treated the indications covered by Medartis implants. Offered were symposia, workshops, and satellite-based events that had attracted more than 12,000 participants since 2008.

Surgical sets were placed through Medartis in cooperating hospitals consisting of surgical instruments and implants for a large number of different surgical procedures. These sets represented a significant investment by Medartis as sets were placed on consignments and did not immediately result in direct billings.

The third and final part of the business model was based on actual use of implants and surgical instruments from sets on consignment. When kits were replenished, the used portion was billed to the hospital and represented Medartis actual sales volume.

It is best to control selling, education, and training to direct the business. What is essential is “control influence” (Willi Miesch).

Medartis employed a field sales force across the globe of about 200 representatives who averaged 11 years of field sales experience. Both its Chairman, Thomas Straumann, and its CEO, Willi Miesch, maintained direct, active, and intensive contacts with the surgeon community.

Expanding the Global Market Footprint

When Medartis went first to market, the company tried to leverage its connections to the Straumann Dental company using its distribution system. Medartis quickly realized that this did not work and began to build its own distribution system based on sales subsidiaries and distributors not related to Straumann Dental. International expansion began in 2002 with the opening of sales offices in Germany, Austria, and France. A number of sales subsidiaries followed in the UK (2003), the USA (2004), Mexico and Poland (2008), and in Australia and Spain (2010). The most recent sales subsidiaries were formed in 2018 through the acquisition of the local distributor in Brazil and a new operation in Japan.

In addition to its 11 sales subsidiaries employing about half of its staff, Medartis products were also sold in 40 countries through 35 distribution partners, collectively accounting for about 15% of sales.

Geographically, more than half of Medartis sales took place in Europe (55%), followed by Asia (18%), USA (15%), and the LATAM region (11%).

Pushing Technology and Development

Medartis spent about 10% of sales on research and development. In actual fact, this was more development than research as the company was using only approved materials for its implants and did not engage in any material sciences-related research. Development involved the function of implants and geometry or shape. The purpose was to round out the product line and to push into new areas, such as shoulders.

Colocating Production and Operation

Initially, Medartis produced prototypes in Germany and outsourced production into the watch belt of the Swiss Jura region. As the company grew, Medartis adopted a model of a totally integrated production under its own control. Located in the same building as its sales, development, and administration functions, a crew of about 75 was responsible to produce the entire Medartis portfolio on fully automated and robot-enhanced lines. The company operated on a 24/7 model with three shifts, with only one shift manned. IoT was implemented throughout. Relevant production and process knowledge were owned by Medartis. *Colocation is important to us* (Miesch).

The fact that Medartis employed exclusively titanium as materials for its implants carried some special production challenges. Medartis machined its screws (not milled or cut with water jets). The company developed its production processes to the point where machining time was as short as for stainless steel screws or plates, leading to savings through efficiency. Machinery was first sourced from Switzerland, but then Medartis switched to a German supplier who offered better service, even on a Sunday when required.

Since all value added took place in Switzerland, Medartis could use the labels *Made in Switzerland* or *Swiss Made* for marketing purposes.

Excellence in engineering and software programming guaranteed top quality and efficiency. Concerning the upward valuation of the Swiss Franc vs. Euro or USD, the company believed it *just would have to deal with it* and would not consider moving parts of the operation elsewhere.

The most recent FDA inspection was passed without any deficiency. “Precision in Fixation” was the company’s credo.

Managing and Attracting Talent

Having its operation in Basel allowed Medartis to tap into the regional supply of top talent for mechanical engineering and software development. *Their commitment is exceptional. This talent would not be transferable to China* (Miesch). Despite its closeness to the German and French borders, the company employed few border commuters in its operation.

When it came to staffing its managerial and governance positions, Medartis could tap into a pool of former executives with deep experience gained at Stratec/Synthes medical implant operations, as well as at the US firm Stryker and Straumann Dental.

Providing Financial Resources and IPO

When Medartis was formed in 1997, the fledgling operation was essentially “nonbankable.” Thomas Straumann, in his role as sole owner and founder, assumed

the role of investor and, until the company reached profitability, loaned an amount in excess of CHF 100 mio to cover accumulated development costs and losses. *Without Thomas Straumann, there would be no Medartis today!* (Miesch).

Having turned the corner and reaching profitability, Medartis undertook an IPO on the Swiss stock market in 2018 that brought in fresh capital for future expansions, allowed the repayment of private loans, and brought in some CHF 120 mio in additional liquidity that could be used for eventual expansions or M&A activities. All of the IPO proceeds flowed into the company, and existing shareholders did not sell any of their shares.

The announced goal was to reinvest any profits back into the business. The company was now essentially debt-free.

The IPO did not materially affect control of the company. Free float in the stock market amounted to 25% only, with the remaining 75% firmly in the hands of ownership and management.

Governance at Medartis

Despite the listing on the Swiss stock exchange, Medartis remained a closely held company. However, the company was bound by the stock market reporting requirements in the composition of its board of directors. The board, which consisted of majority shareholder Thomas Straumann and CEO Willi Miesch, also included an outsider as a third member.

Reporting was according to Swiss GAP requirements, a fact that required more paperwork than previously but did not materially affect the running of the company.

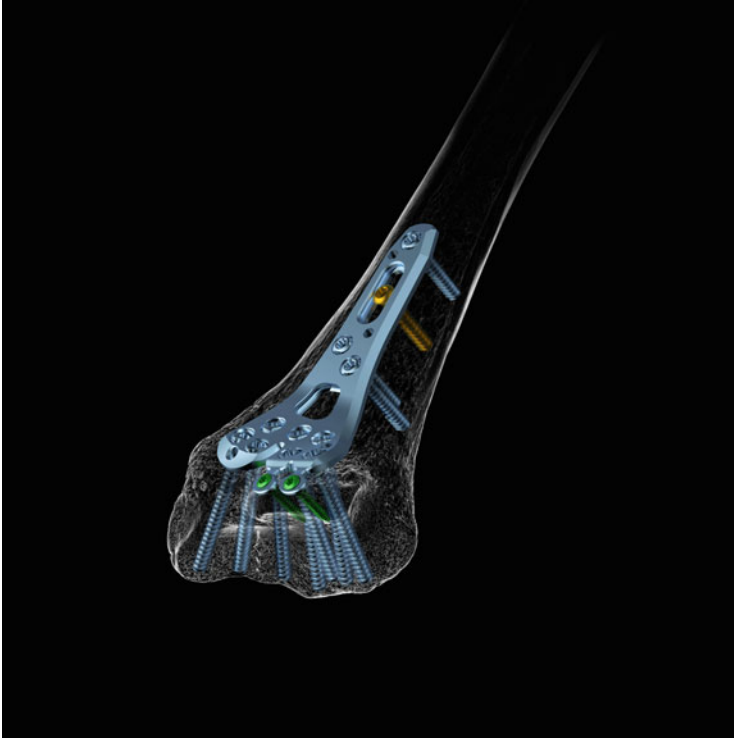

Exhibit 26.29 Medartis product

Company Profile 35: u-blox⁵⁸—Global Leader in Embedded Positioning and Wireless Communications Solutions. Connecting Machines, Vehicles, and People to Exact Positions

From Start-Up Idea to World Leader in Just 20 Years

Each year, u-blox supplied millions of devices in the form of modules or chips that helped in the determination of exact positions in industrial settings, in millions of automotive vehicles, or in a wide range of smart consumer devices. Hidden away from view to the end user, whether in factories or while driving, these modules had become essential in the workings of the High-tech economy. Started as a venture of three students in 1997, the company had reached sales of CHF 393 mio (2018) and

⁵⁸This company profile was written by Jean-Pierre Jeannot (Professor Emeritus Babson College [USA] and IMD Institute [Switzerland]) on the basis of a company interview as well as from public information. Copyright©2019.

total worldwide employment amounted to about 1050 (2018). About 7000 OEM customers in more than 50 countries relied on u-blox products.

Three Students Convinced They Could Do Better

In 1997, three PhD students at the ETH Zurich, Daniel Ammann, Andreas Thiel, and Jean-Pierre Wyss, all under the supervision of Professor Gerhard Tröster, Professor for Digital Systems and Wearable Electronics, decided to leave their academic studies to start u-blox for the purpose of developing and marketing electronic modules for producers of communications systems with early emphasis on miniaturized GPS receiver modules. They left the ETH academic program with a MA Diploma in hand.

The three students had studied an earlier invention and patent from the USA. Realizing that then current GPS systems based on several satellites could take 1–5 min to be activated, required seven to eight to establish a true position, the student team collaborated and found several algorithms to accomplish this faster, use less field intensity than previous systems, do with less electric field strength, and finally, accomplish the task faster than previous systems. These improvements provided substantial benefits to users of positioning systems.

Formulating a Business Plan for a New Company

In September 1997, u-blox AG was founded with the three students and their ETH supervisor as initial shareholders. Starting first in rented office space at ETH Zurich, they later moved into their own space. Although the team had benefited from their educational experience at the ETH, this start-up involved no IP held by the university and thus could not be characterized as a formal spin-off from ETH Zurich.

The founding team had ambitious goals and envisaged in its original business plan from 1998 that u-blox would achieve sales of 150,000 modules in 1999, reaching a sales volume of more than CHF 60 mio by 2002. At this time, u-blox did not have any manufacturing capabilities or capacities of its own. About one year after start-up, u-blox presented its first surface-mounted GPS receiver.

Capitalizing on Early Successes

Right at this time, the Swiss Customs Agency was looking for devices that would help administering the LSVA (Performance-Related Heavy Vehicle Charge) to be introduced for charging trucks for road usage. The devices were required to include a GPS receiver. Beating out such heavy weights as Motorola and Trimble, start-up u-blox was able to land an order for 60,000 modules that were delivered in 2000. Manufacturing was performed by Siemens, the German global company. The order

generated volume of CHF 17 mio and put the young company on the road for success.

The young company grabbed the next opportunity of integrating its GPS modules into mobile phones. Overcoming technical design challenges, u-blox convinced the Finnish mobile phone producer Benefon to integrate the u-blox design and modules, requiring delivery commitments of 50,000 modules per month. Production was handled by Tyco, a US-based company that had taken over the Siemens operation which had produced the earlier modules.

Surviving Ups and Downs

After these early successes, u-blox hit its first real bump on the road when its large, Finnish mobile phone customer was unable to pay for u-blox deliveries. This resulted in a huge inventory of 140,000 unsold GPS modules and accumulated debt of EURO 9 mio with the module supplier. The unwillingness of investors and banks to continue to support the company brought about a financial crisis. Combined with the 9/11 attacks in New York in the same year, survival of the business was in question.

In 2001, u-blox adopted a new business plan with reduced ambitions. Despite a lack of new investment capital, u-blox managed to find customers for the huge module inventory and renegotiate, as well as repay, the outstanding debt to its main supplier. To survive, layoffs and reduced time in 2002 and 2003 had to be implemented.

The founders were aided in their turn-around effort by the loyalty of early stage investors, particularly under the leadership of H.U. Müller from Partners Group, who also functioned as Chairman of the Board for the first few years, as well as through the appointment of Thomas Seiler as external CEO. Losses incurred during the 2002 to 2003 period were absorbed by the initial set of investors.

Throughout this time, u-blox continued to develop and improve its GPS modules with such innovations as the ANTARIS[®]-based GPS modules, Dead Reckoning positioning products for use in tunnels, and SuperSense[®] indoor GPS technology. By 2004, u-blox achieved sales of CHF 28 mio and returned to profitability, reporting a profit of CHF 3.7 mio.

Creating an Ever-Expanding Product Platform

Initially, u-blox developed a first surface-mounted GPS receiver which was accomplished in the second year of the company's existence. Starting with this first product, the company developed modules from purchased chips that could be integrated into different kinds of devices in need to communicating positioning information using GPS. Continued development brought u-blox into the area of wireless communication, a range of communications technologies, and into an ever-growing range of industrial applications. Over time, u-blox improved its products

from one generation to another, constantly offering ever smaller profiles, reducing the energy required, and lowering user costs.

Its products fell into several categories around the types of communication required. The company offered cellular-based chips and modules, short-range radio chips and modules, and positioning chips and modules. They were also classified into providing positioning and time, cellular-based, or short-range applications. The product line offered solutions for all wireless communications protocols, ranging from bluetooth and low energy to Wifi or GSM. Its products were offered in many different combinations and could be engineered to the specific requirements of a customer.

Differentiating Its Business Model

When u-blox entered the market with its first products, there were well-established suppliers of GPS positioning and navigation systems, such as TomTom. However, these OEM and end-user product suppliers were unwilling to supply just their chips or modules. Automotive companies were interested in acquiring navigation and positioning system that they could integrate into their own in-car display systems. u-blox recognized this market gap and created easy-to-integrate systems for OEMs for cars and other devices. Since u-blox did not enjoy brand recognition, it took about one year for the company to obtain its first big orders.

The modular product line allowed OEM customers to find the ideal combination for integration into their own system.

Building a “Fabless” Supply Chain

u-blox did not produce any chips or modules. Chips were designed by u-blox and sourced from several fabricators in different Far East locations. They were shipped to an integrator company in Graz (Austria), Flextronics, for final assembly and direct shipment to OEM customers.

The role of u-blox was to design all products and to ensure quality. The company had designed its own quality control methodology of testing 100% of output. Full traceability of manufacturers and suppliers was arranged to manage any kind of risk, political or otherwise.

A dedicated supply chain unit was operating from the company’s location in Thalwil, Switzerland. This unit, headed by Wyss, one of the three founders, and also serving in the role of COO of the company, consisted of about 30 employees. Its location in Thalwil was internally referred to as the “Silverhouse.”

Adopting a Unique Development and Innovation Philosophy

To drive its innovation, u-blox invested about 20% of sales in development. The company did not engage so intensively into research but concentrated on development. Concentrating on technology applications, the company wanted to be ready for the next technology phase. This required extensive collaboration with universities and being in constant contact with the market to correctly spot the latest emerging trends. Only then did u-blox decide on commercialization of new ideas.

The direction of innovation was managed by the heads of the company's two business units, Positioning and Communication, headed by co-founders Ammann (Positioning) and Thiel (Communications) who functioned as co-CTOs for the company. Both units had a dedicated team of development engineers located in different countries.

u-blox operated 15 research and development centers across the world. Its acquisition strategy was closely linked to the need to gear up development capacity. Starting early in its development, the company concentrated on acquiring engineering teams abroad, avoiding operating businesses and leaving them in their original location. Relocating all of these specialists to the Swiss operation would have resulted in losing many engineers. Leaving them in place meant that engineers could continue working from where they wanted to live with their families. Some of these teams were very small, just a handful of staff, with the largest one in Italy with a staff of about 100.

The development process was coordinated by the company CEO, Seiler, and assisted by the two co-CTOs. At any time, there were about 300 projects in the pipeline, of which 100 to 200 were major ones and the rest variants of others. It was CEO Seiler who developed the process for development groups that were working globally dispersed. They would connect regularly online to discuss technology and design only, using a particular routine.

Teams would always meet on the same day of the week for a given project or device. These online meetings would be for a duration of 30 min to 2 h. Timings were rotated such that, as an example, the Thalwil Head Office team would be on in the morning in week 1, around noon in week 2, in late afternoon in week 3, and in the very early morning in week 4. Then, the rotation sequence would be repeated. Other teams in other locations and time zones would adjust accordingly. As a result, a given team would only have one inconvenient meeting time over the 4-week cycle. This meeting schedule was designed to minimize travel for development engineers. Instead, it was the co-CTOs Ammann and Thiel who traveled between the teams.

If there was an innovation philosophy at u-blox, it could be described as applying new technology for use of its customers, not so much as inventing technology. This still challenged the company to be ready to move early on the next phase of an emerging communication technology to be the fastest to apply the new technology. Spotting trends was therefore essential so that the company could decide on what and when to commercialize.

This philosophy of technology development was also evident in the product technologies adopted. At the outset, u-blox tended to acquire chips on the open

market and adapted them, through modules, for its use. With more experience gained, the company eventually shifted to its own chips once the applications began to mature. The first u-blox chip-set was brought to market in 2007. Others followed.

Managing the Global Sales Effort

Sales to OEM customers were in the hands of three crews with regional concentration on Europe, North America, and Asia/Pacific. These teams could count on the support of 13 sales offices and about 50 distributors in key countries. Opening international sales offices started early when u-blox opened USA and Asia offices in 2001. u-blox geographic sales (2018) were about evenly divided between Asia/Pacific (35%), Europe/EMEA with 32%, and the Americas with 32%. Sales to Switzerland, the head office location of the company, accounted for less than 1%.

Coordination of the sales effort was largely the responsibility of Seiler, who as CEO of the company also functioned as the de-factor CMO until spring of 2019, when a dedicated global marketing officer was appointed. Sales teams and their members traveled extensively.

The sales teams worked on requests for products by OEMs. u-blox sold components and chips, with the former making up the majority of sales. The company did not market GPS products as naked products, nor did it market to end users. The company faced a few major competitors in the OEM business, namely Trimble (UK) and Gemalto (NL). In addition, there were the GPS product suppliers, such as TomTom, who developed GPS as stand-alone products and were part of larger companies. Qualcomm, a US company, was at times both a competitor and a partner.

Selecting Market Segments and Applications

The focuses of u-blox sales were the segments of industrial, automotive, and consumer applications. The industrial segment made up about 55% of sales and included a wide range of applications, from fleet tracking to cargo monitoring, street lighting, and medical devices, based on the company's 4G and 5G cellular systems-based modules. With the Internet of Things (IoT) becoming a reality, volume in this segment was increasingly driven by this new mega-trend.

The automotive segment accounted for about 30% of company sales. The increasing technical requirements for cm-level precision positioning and secure vehicle-to-everything communication needs were driving this sector with u-blox the leader in bringing new generations of products to market. The growing market for electric vehicles and autonomous driving was also a dominant growth factor.

The consumer segment, coming to about 10% of sales, was driven by the growing demand for smart technology in sport and fitness equipment, people and pet trackers, action cameras, robotic lawnmowers, and consumer drones.

Concerning the selection of applications and customer requests, the company needed a minimum of units per year to bring a new application on stream. As a result, u-blox did not focus on small unit applications. The company did not intensively serve the aerospace market, whereas such applications as container shipping were of interest due to the sheer number of containers in use.

Financing the Growing Enterprise with External Capital

When u-blox was founded by the three student founders and their professor, financing came from a group of friends and family members. Soon, however, the private equity firm Partners Group (Zug) joined as a major investor. The contact came in the wake of the founders circulating an aggressive business plan in 1998 to entice investors. Following initial orders and landing the large contract with the Finnish mobile phone company in 2000, the company was also able to attract the UK investment company 3i to join.

The difficulties with the Finnish customer and the resulting financial losses meant that the UK investor declined to further invest needed capital. At this time, new investors could not be recruited. Through capital write-downs and restructuring, the company could return to positive business results in 2004. Positive cash flow allowed the company to raise one last capital injection from Partners Group and to IPO the company successfully on the Swiss Exchange in 2007. Just prior to the stock exchange crash in 2008, the company managed to raise CHF 60 mio in capital and set it aside for future use and likewise raised CHF 60 mio in bonds because the terms were good. These funds were treated as reserves for future acquisitions. During this time, the shareholding of Partners Group declined from a high of 45% to a much smaller percentage. Currently, leading shareholders were institutional investors, such as Blackrock, CS, and UBS funds.

Management and Company Governance

The three company founders and the CEO who joined the company in the early growth phase remained with the company largely in their same roles. The founders concentrated on the technological issues of the business, whereas additional talent was hired for other administrative and functional roles from CEO to CMO and CFO. The company's executive committee of five members included the three founders. Over time, the company founders moved from the initial entrepreneurial and start-up roles into their managerial positions.

As a company quoted on the Swiss stock exchange, u-blox complied with all required board structures and committees. Financial reporting was done under IFRS standard. The board of directors comprised seven individuals, of which only the CEO and one of the founders had operating roles at the company. The other five members were nonexecutive directors. The external board members had backgrounds and experiences with a variety of international technology companies

as investors, consultants, or executives. Both governance and management combined held less than 5% of all outstanding shares.



Exhibit 26.30 u-blox product

Company Profile 36: Wyon AG⁵⁹—Champion of Small Batteries. Developer and Producer of Rechargeable Li-Ion Batteries

Wyon was located in the village of Steinegg near Appenzell, one of the most idyllic places of Switzerland, surrounded by cow pastures and mountains. In sharp contrast, and totally unexpected for this setting, upon entering the company one suddenly was in a completely different world, surrounded by staff in white laboratory coats, working in laboratories and in clean room facilities. Wyon, specializing in developing and producing rechargeable, small micro-sized, Li-ion batteries, exported almost

⁵⁹This case was written by Heiko Bergmann (Adjunct Professor of Entrepreneurship University of St. Gallen) on the basis of a company interview as well as publicly available information. Copyright©2019.

100% of its production. Founded in 1999 in a garage, by 2018, the company had grown to employ more than 100 people.

Undertaking an Apprenticeship as Entrepreneur

When Paul Wyser started Wyon in 1999, he was 53 years old and could look back on a long career in the watch industry that prepared him for his eventual entrepreneurial venture. Born in 1946 in the Basel-Land (BL) canton, Wyser had completed an apprenticeship as mechanical draftsman at Institute Straumann, located in the region, a company that was responsible for many innovations in the watch and medical industry. From there, Wyser eventually joined Renata, a company producing mechanical watch components. With the growing importance of quartz watches, Renata built production lines for button cells used in watches, ultimately becoming a world leader in this market. Renata was acquired in 1982 by Swatch Group, and Wyser became member of the extended group management team, rising to the position of manager of the technical area which included production.

Wyser's entrepreneurial training took place under the direction of Nicolas Hayek, CEO and Chairman of Swatch Group. One of his tasks was to restructure unprofitable watch component companies owned by Swatch which he was to undertake without any additional financial resources, relying on company-internal resources only. Those lessons learned were later applied when starting up Wyon.

Recognizing an Emerging Business Opportunity

In the 1990s, the company considered entering the production of rechargeable batteries for mobile phones in Switzerland. However, Wyser was skeptical about this project because Japanese and Korean firms had been producing such batteries already for several years. Instead, he proposed to produce batteries for new medical applications, a market which Swatch had no interest in entering.

Paul Wyser, through extensive business contacts in the battery industry and in related fields, including with hearing aid specialist Phonak, knew that there was demand for rechargeable battery solutions by the medical industry. This realization was the starting point for a new business idea which took some time to fully mature. Yet, the basic idea for the company, to develop and produce customer-specific rechargeable batteries with a plastic housing, came from there. In 1999, he informed his two sons, Maurus and Philipp Wyser, of his desire to start his own business based on this rechargeable battery opportunity, provided they would join. In the very first email that Paul Wyser had ever written in his life, he asked his son Philipp, then 26 years old, a chemist, and at that time in the USA, if he would join. Philipp and his brother Maurus, a trained technician, agreed and the three started a company and named it Wyon. The small team included Wyser's wife, Marie-Theres, taking care of accounting.

Focusing on Customized Batteries

From the beginning, Wyon's goal had been to develop and to produce rechargeable battery solutions for the medical market with focus on end-user benefits. The Wyser team intended to produce something radically new which nobody had ever attempted before, to justify the premium price necessary to support production in Switzerland. In the first 5 years of its existence, Wyon focused almost exclusively on product development, on demonstrating that their idea was workable, engaging in extensive engineering.

Starting Operations in a Garage on the Alp

During the first 5 years, the team operated without a dedicated company building. Wyon was set up in the garage of Paul Wyser's house above the town of Appenzell, at an altitude of 1100 m. The family had settled there, because Paul's wife came from the region. Because it had always been important for the founders to remain independent, they declined funding from outside investors, leaving Wyon financially limited. Exceptions were a personal friend and a business partner who invested seed money, but without imposing any conditions. The Wyser family invested their private funds into a venture that many outside observers thought had little chance for success. Wyser continued working as an external consultant for Swatch Group, providing the main source of income for the development work during the initial years of the company.

Utilizing and leveraging the network Paul Wyser had built during his business career, the Wysers were allowed the use of different equipment at several institutes and companies, albeit located in different places across Switzerland and neighboring countries. This could turn out to be quite cumbersome. For example, to produce a battery prototype in the early days of the company, Philipp Wyser would start working first in their garage, going as far as he could with his limited equipment. He then drove to a company in Bronschhofen (TG), about half an hour away, where he could perform an ultrasonic welding operation. Another hour's drive would take him to Basel, where he could use a glovebox he needed at the university. In Zurich, the location of Phonak, he was allowed to charge his batteries. Overall, it took about 2 weeks until a new battery prototype was ready. However, before investing in their own equipment, the founders wanted to prove to themselves that their batteries would work in principle.

Employing Plastics Technology

Wyon was founded on the principle to produce customized batteries only. For those applications where space for a battery was at a premium, standard cells were unable to generate a maximum of energy within a limited space. Standard cells were typically made of deep-drawn aluminum or steel sheet which limited shaping. To

overcome this space and shaping problem, the idea of using plastic materials emerged. Using plastic injection molding process, it was possible to produce specially designed shapes, allowing for a maximum of energy density within the available space. The lower weight of the plastic material, compared to metal, was another advantage in many medical applications.

However, the initial problem the team encountered with plastic materials was the fact that plastic absorbed humidity, releasing it inwards. Lithium ion was moisture-sensitive, and over time, the plastic material would destroy the chemistry of a battery. To counter this, Wyon had to use a plastic material that absorbed humidity only minimally, while having to find ways to weld it together with an electrolyte inside, employing seal welding as an additional challenge. Materials, including plastics, foils, and electrolytes, were purchased from suppliers, optimized to Wyon's needs, with Wyon focused on building the battery cases and interiors.

Landing an Australian Company as a First Customer

In 2001, just two years after starting up, the Wyon founders had the first prototypes up and running, still containing some defects. It was at this time that a large Australian company and worldwide leader for cochlear implants had been looking in vain for a supplier of rechargeable batteries for their purposes. They were in collaboration with Phonak who recommended that they approach Wyon. The Australians visited Appenzell when Wyon was still operating out of the garage. Convinced that Wyon was the right partner for the development of rechargeable batteries, they gave the green light for the development of a first prototype.

Philipp Wyser, Wyon CEO, explaining Wyon's specific market niche and why their first customer had not previously been able to find a suitable supplier:

If you go to a battery manufacturer and say that you want a special shape, then the first question is: "In what quantity?" At this time, the Australians only needed 30–40,000 batteries a year, and then, the battery manufacturer typically said: "Here you have my catalogue, choose a standard battery. If we're talking about a million a day, we'll make a special one for you." They just don't do that, it's not worth it for them to change their equipment for 30,000 units. In principle, this is also part of the market niche we have worked on, that we are somewhere where others don't want to go.

Wyon targeted the implant hearing sector because the standard hearing aid sector was simply not yet "ready" for rechargeable batteries, as audiologists partly earned their living from the exchange of batteries.

At first, Wyon built a prototype, because the customer wanted to see something tangible. Then, at the end of 2003, Wyon started development of the necessary processes and systems, which took about a year. Finally, in 2005, Wyon moved out of its garage, rented its first commercial premises in the village of Appenzell, and commenced production for the Australian company.

Improving Production Processes

From 2005 to 2008, Wyon focused on establishing and improving production processes, slightly improving design and battery technology. To improve quality, Wyon needed to develop better processes. For the medical industry, traceability was of extreme importance, especially for companies working with implants. Right from the start, every battery was given its own serial number to provide full traceability, distinguishing Wyon from other battery producers. Based on all data required for traceability, Wyon then set up its quality system, structuring data for use to directly control production. Based on this system, Wyon was able to detect production errors and intervene in real time, avoiding monthly quality assurance sessions.

Adopting Stacking Technology

Beginning in 2008, Wyon further optimized its battery technology. Wyon worked together with its suppliers on the chemistry to increase energy density, applying stacking technology. While Wyon had not invented this technology, it patented, improved, and applied it for its purposes, allowing for smaller battery sizes and special shapes. Stacking technology enabled Wyon to produce batteries in two dimensions not previously available. Partnering with a well-known American company in the 2010/11 period Wyon engaged in a development project for a microbattery with a height of 2 mm and a diameter of 2 mm. While Wyon successfully developed the battery, the OEM had not yet finished the end product. Wyon used the expertise acquired years later on a project for a different customer, who had been looking for a microbattery solution for some time, unable to locate a supplier until connecting and starting the project with Wyon.

In 2013, Wyon completed a new office and production building following the environment-friendly Minergie standards and relying on local construction companies as much as possible.

Retooling for Larger Market Segments

For many years, Wyon was exclusively focused on the cochlear implant sector, growing with its customer base. In 2017, Wyon served about 70% of the world market for cochlear implant batteries, a market still expanding. While the Australian company was the biggest supplier of cochlear implants, other major players also became Wyon customers.

Wyon could have grown much faster but decided against it, as growing according to plan had always been important to Wyon as not to risk losing its team spirit corporate culture. That is why for many years, Wyon did little to no marketing and did not approach other customers. For this reason, it was only in 2013 that Wyon

attended a trade fair for the first time starting to build up the know-how on how to best market itself.

In 2015, Wyon began with the development of standard-sized batteries by constructing a second production hall. This new direction was to complement and change its original strategy. Wyon realized a need to minimize the risk of being active in a single segment only. The biggest obstacle for moving into other segments had mostly been costs. Producing customized batteries had been its main activity. Wyon production processes still included many manual steps, resulting in high prices that not everybody was willing or able to pay. In 2017, when Wyon decided to automate production, the company produced at a level of 300,000 units per year. The first fully automatic production line in the new building had an anticipated output of 1.2 million units per year. The building was designed to house three such automated production lines. While still not comparable to the price of a standard battery, such as those used in mobile phones, the price for a battery produced on automated lines was significantly lower, allowing Wyon to serve other markets.

Despite not intending to serve the mass market, Wyon still aimed at standardizing part of its product line to establish a “Wyon Standard.” This standard was optimized for existing customers while providing Wyon with the flexibility to react to new customer requirements. Producing the same, or very similar batteries, on the same line for different customers and then sell it to several customers could not be offered by competitors. Wyon placed great importance on its new production platform, expecting it to enable approaches to other markets. The initial focus on the medical market would still remain, with the potential to serve other markets reserved for later. As a further strategic development, Wyon had decided to develop and produce implantable rechargeable batteries for diagnostic and therapeutic applications.

Leveraging Regional Resources

Starting up a production and growing the company while building an entire local team presented a challenge, especially in a rural place such as Appenzell. Because of its special requirements, Wyon had to train staff for a considerable length of time. Wyon was looking for employees who had, at a minimum, completed an apprenticeship in a related field. Wyon, with its focus on quality, believed in the higher reliability of well-qualified personnel. Most of Wyon’s staff was from the Appenzell region.

In 2017, employees from diverse professional backgrounds worked for Wyon, from polymechanics to electrical engineers, aeronautical engineers, chemists, automation engineers, and software engineers. Employing staff with a diverse background was seen as advantageous, allowing the company greater flexibility for moving into new technological fields. So far, filling open positions had not posed problems. Many well-qualified and educated applicants could not find positions locally. Appenzell residents were attached to their region and eager to work near where they lived. A large part of the company staff went home for lunch, a common practice in the Appenzell region. Wyon, with a good reputation in the region, rarely

needed to advertise for production employees. Simply spreading the word within the company led to sufficient suitable applications. Staff fluctuation was also low, with the company occasionally losing female employees when they started a family. Some would continue to work later on part-time. Wyon was prepared that it might eventually reach a critical size for Appenzell and that it might need to recruit more people from beyond the region at some stage.

Continuously Improving Technology and Products

One-third of Wyon's employees worked on development projects, including developing the entire new plant, including all systems. Development speed was important for Wyon, resulting in a competitive advantage. While the plastics material technology could, in principle, be duplicated, Wyon had so far not come across copies of its battery design since the production processes were particularly complex. It had taken Wyon years to make them work. Still, Wyon was convinced that it could not afford to stand still and always needed to be one step ahead of the competition, such as by initiating development into microbatteries.

To understand the requirements, Wyon sought a close cooperation with its customers, visiting its clients in Australia at regular intervals. In its role as premium supplier, Wyon wanted not only to offer top quality but also to cultivate close cooperation, an approach to business relations appreciated by customers.

As a strategy for the future, Wyon placed great importance on the new product platform which enabled them to approach other companies. The initial focus would remain the medical market, with the potential to serve other markets. In doing so, Wyon always pursued the principle of sustainability, balancing the economic, ecological, and social dimensions of its activities and decisions.



Exhibit 26.31 Wyon battery system

Open Access This chapter is licensed under the terms of the Creative Commons Attribution 4.0 International License (<http://creativecommons.org/licenses/by/4.0/>), which permits use, sharing, adaptation, distribution and reproduction in any medium or format, as long as you give appropriate credit to the original author(s) and the source, provide a link to the Creative Commons license and indicate if changes were made.

The images or other third party material in this chapter are included in the chapter's Creative Commons license, unless indicated otherwise in a credit line to the material. If material is not included in the chapter's Creative Commons license and your intended use is not permitted by statutory regulation or exceeds the permitted use, you will need to obtain permission directly from the copyright holder.

