

PROCEEDINGS OF THE INTERNATIONAL CONFERENCE  
HELD BY COST ACTION IE9401  
Florence (Italy), 8-10 November 2007

# Wood Science for Conservation of Cultural Heritage

Florence 2007

Edited by  
**LUCA UZIELLI**



## Proceedings e report

57

To follow:

*Wood Science for Conservation of Cultural Heritage – Braga 2008 – Proceedings of the International Conference held by COST Action IE0601 in Braga (Portugal), 5-7 November 2008*

*Wood Science for Conservation of Cultural Heritage – Hamburg 2009 – Proceedings of the International Conference held by COST Action IE0601 in Hamburg (Germany), 7-9 October 2009*

**Scientific Committee and Refereeing.** Each paper published in these Proceedings has been peer-reviewed by anonymous Referees, under the responsibility of the Steering Committee of the Action, also acting as Scientific Committee of these proceedings:

Helena Cruz, George Jeronimidis, Joseph Gril, Roman Kozlowski, Eberhart Lehmann, Thomas Nilsson, Tone Marie Olstad, Luca Uzielli.

# Wood science for conservation of cultural heritage – Florence 2007

PROCEEDINGS OF THE INTERNATIONAL CONFERENCE  
HELD BY COST ACTION IE0601 IN FLORENCE (ITALY),  
8-10 NOVEMBER 2007

Edited by  
LUCA UZIELLI

FIRENZE UNIVERSITY PRESS

2009

Wood Science for Conservation of Cultural Heritage – Florence 2007 :  
Proceedings of the International Conference held by COST Action IE0601 in  
Florence (Italy), 8-10 November 2007 / a cura di Luca Uzielli. – Firenze :  
Firenze University Press, 2009.  
(Proceedings e report ; 57)

<http://digital.casalini.it/9788884533968>

ISBN 978-88-8453-382-1 (print)  
ISBN 978-88-8453-396-8 (online)

The financial contribution of COST Action IE0601 and of University of Florence for covering the publication costs of this volume are gratefully acknowledged

Progetto grafico di Alberto Pizarro Fernández

© 2009 Firenze University Press

Università degli Studi di Firenze  
Firenze University Press  
Borgo Albizi, 28, 50122 Firenze, Italy  
<http://www.fupress.com/>

*Printed in Italy*

## SUMMARY

<b>Introduction</b>	p.	5
<b>Session managed by WG1</b>		
Thomas Nilsson, Roger Rowell <i>Historical wood – structure and properties (Keynote lecture)</i>	“	11
Eiichi Obataya <i>Effects of ageing and heating on the mechanical properties of wood</i>	“	16
Nicola Luchi, Paolo Capretti, Aniello Scala <i>Detection and early identification of decay fungi: from standing trees to wood substrates</i>	“	24
Maria Petrou, Rob C. Janaway, Gill B. Thompson, Andrew S. Wilson <i>Degradation mechanisms of waterlogged archaeological pine timber from northern Greece</i>	“	28
Diego Dreossi, Stefano Favretto, Marco Fioravanti, Lucia Mancini, Luigi Rigon, Nicola Sodini, Giuliana Tromba, Franco Zanini <i>Synchrotron radiation microtomography: a non-invasive tool for the characterization of archaeological wood</i>	“	34
János Veres <i>“I was walking in an 8 million years old forest...”</i>	“	40
Irena Kučerová, Martina Ohlídálová, Miroslava Novotná, Alena Michalcová <i>Examination of damaged wood by ammonium phosphate and sulphate-based fire retardants – The results of the Prague Castle roof timber examination</i>	“	43
Magdalena Zborowska, Leszek Babiński, Bogusława Waliszewska, Włodzimierz Prądzyński <i>State of preservation of historic wood from fortified settlement of the Lusatian culture in Biskupin (Poland)</i>	“	48
<b>Session managed by WG2</b>		
Dario Ambrosini <i>Optical techniques in wooden paintings diagnostics</i>	“	55
Hiltrud Brocke, Jochen Aderhold <i>Infrared imaging techniques for the study of paintings and other artwork</i>	“	62

SUMMARY

Jean Angelo Beraldin, Francois Blais, Marc Rioux <i>Diagnosing wood artworks surface through state-of-the-art high-resolution optical 3D imaging techniques</i>	“	69
Uwe Noldt <i>Monitoring wood-destroying insects in wooden cultural heritage</i>	“	71
Irena Kučerová, Burghard Schillinger, Elbio Calzada, Eberhard Lehmann <i>Monitoring transport of acrylate consolidants through wood by neutron radiography</i>	“	80
Khôi Tran <i>Various physical and analytical methods to control the impregnation efficiency of archaeological artefacts by different consolidating resins</i>	“	86
Ottaviano Allegretti, Francesca Raffaelli <i>External resistance to water vapour transfer of varnishes on wood</i>	“	93
Manuel F.M. Costa <i>Microtopographic and rugometric inspection of wood artefacts</i>	“	100
Anna P. Moutsatsou, Eleni Kouloumpi, Johanna Olafsdottir, Maria Trompeta, Christina Tsaroucha, Michael Doulgeridis, Roger M. Groves, Vivi Tornari <i>Protocols for the construction and characterization of model panel paintings for the evaluation of structural diagnosis techniques</i>	“	105
Krzysztof Chmielewski <i>Investigation of paint layers of the fifteenth century Saint Barbara polypych from the collection of the National Museum in Warsaw</i>	“	110
Ludmila Otilia Cinteza, Gheorghe Niculescu <i>Diagnosing efficiency of cleaning old wooden objects using new o/w microemulsions with environmental friendly components</i>	“	115
<b>Session managed by WG3</b>		
Charlotte G. Björdal, Thomas Nilsson <i>Understanding microbial degradation of waterlogged archaeological wood</i>	“	123
Roman Kozłowski <i>Target microclimates for preservation of wooden object: an attempt at standardisation</i>	“	127
Marco Ciatti <i>Experiences and problems in panel paintings conservation</i>	“	133
Elżbieta Jeżewska <i>Needs for conservation of paintings on engineered wood supports</i>	“	137
Jolanta Ratuszna <i>Microclimate in the Malbork Castle, Poland: selection of heating strategy to preserve wooden objects</i>	“	144

Daniel-Constantin Negut, Corneliu Catalin Ponta, Rodica Maria Georgescu, Olimpia-Hinamatsuri Barbu <i>Colour tests for irradiated painted wood panels</i>	“	148
Huub Baija <i>Consolidating wooden art objects</i>	“	151
Mine Tanac Zeren <i>Comparison of the deterioration and conservation issues of wooden door types of traditional Turkish houses</i>	“	153
Özgül Yılmaz Karaman <i>Structural use of wood in traditional Turkish houses</i>	“	157
Lina Nunes, Dulce F. Henriques, Jorge de Brito Helena Cruz <i>Diagnosis of timber structures. A case study</i>	“	161
Hektor Thoma, Dritan Ajdinaj, Etleva Bushati Holta Çota, Entela Lato, Doclea Quku <i>Technological analysis of some Albanian icons, carried out at Department of wood technology, UBT, Tirana</i>	“	167
Sandie Leconte, Sylvie Le Moyne, François Ollivier, Stéphane Vaiedelich, Joel Frelat, David Ley, Christine Laloue, Jean-Claude Battault <i>Mechanical modelization and holography measurement: application to the restoration and conservation of the Couchet Harpsichord</i>	“	175
Jan Marczak, Andrzej Koss, Maria Lubryczynska, Joanna Czernichowska, Izabela Uchman-Laskowska, Krzysztof Chmielewski, Magdalena Mazur, Agnieszka Markowska, Marek Strzelec <i>Wooden art works –Laser cleaning case studies</i>	“	181
<b>Scientific visit, San Marco Museum</b>		
Magnolia Scudieri <i>Monumental buildings and conservation problems: a complex approach</i>	“	191
Paolo Dionisi Vici, Ilaria Bucciardini, Marco Fioravanti, Luca Uzielli <i>Monitoring climate and deformation of panel paintings in San Marco (Florence) and other Museums</i>	“	193
Annex 1 - Facts about COST Action IE0601	“	203
Annex 2 - Final programme	“	208
Annex 3 - List and addresses of Participants	“	215
Annex 4 - List of Authors	“	229





## INTRODUCTION

The kick-off Management Committee (MC) meeting of COST Action IE0601 was held in Brussels on 17-18 April 2007, and mainly dealt with administrative and organizational issues.

A second MC meeting of the Action took place in Tervuren (Belgium) on 8-9 June 2007, together with a Workshop which allowed for an initial approach to the many themes potentially covered by the Action.

No formal reviewed Proceedings from the Tervuren Workshop have been published; however several papers and presentations are now available on the Action's website.

These proceedings, from the Workshop held in Florence (Italy) on 8-10 November 2007, published both in paper and in electronic format, are therefore the first public formal record of the scientific activity developed within our Action.

However, I wish to mention the intensive scientific work which has been and is still being performed within our Action, through Meetings, Short Term Scientific Missions, Training Schools, formal and informal contacts, and several further activities which are listed on our website ([www.woodculther.org](http://www.woodculther.org)).

### 1. A summary report from the Workshop

The Florence Workshop was organized by the Action's Chair, Luca Uzielli, supported by Marco Fioravanti (MC Member), Marco Togni, and by some of his Department's PhDs and PhD Students (Giuseppina di Giulio, Giacomo Goli, Paola Mazzanti, Nicola Sodini).

It took place in one of the meeting-rooms of Hotel Mediterraneo - Lungarno del Tempio 44 - 50121 Firenze (Italy). Participants had the opportunity to walk and browse in the Middle Age and Renaissance streets of the town, in the intervals between the meeting's sessions and the programmed scientific visits, or the meeting's Dinner.

In total 80 Participants attended, coming from 24 Countries (AL, AT, BE, CA, CH, CZ, DE, ES, FI, FR, GR, HU, IT, JP, LV, MT, NL, NO, PL, PT, RO, SE, SI, TR, UK).

Three of the Participants, invited Speakers or Experts, came from Countries being not COST members (Albania, Canada, Japan).

Of the Participants, 37 were MC Members, or substituting for MC Members.

Additionally 12 students from undergraduate courses from University of Florence were allowed to attend the Meeting at no cost.

Annex 1 includes a detailed Program, and the schedule of the presentations (Orals and Posters).

Three plenary sessions of half day each took place, each having been prepared and being managed by one of the three Working Groups. Each session was divided in two parts focusing on specific topics previously agreed by the Steering Committee during the SC Meeting held in Paris on September 1-2, 2007.

Oral presentations were planned to last between 25 and 35 minutes each, depending on the sessions.

Saturday 10th morning, parallel meeting sessions of WGs took place, followed by a short presentation of COST Action D42 "Chemical Interactions between Cultural Artefacts and Indoor Environment (EnviArt)", and by a plenary session including a general discussion and conclusions from the Workshop.

Posters were on display during the whole meeting time, in the coffee-break room and in the nearby corridor, so that Participants could look at them and discuss them with the Authors during any free moment.

A scientific visit took place after dinner on Thursday, November 8th, at the Museo di San Marco, a State Museum exhibiting numerous masterpieces (especially frescoes and panel paintings by Fra'

Giovanni Angelico, a Master of Florentine Renaissance). Located in a former convent founded in 1436, the building is in its own right an artwork to be conserved, also featuring an extraordinary timber roofing. Before the visit the Museum's Director, Dr. Magnolia Scudieri, gave a short lecture about the problems and requirement of a Museum conserving panel paintings and timber structures; a short presentation was also given by Paolo Dionisi Vici and Luca Uzielli, dealing with researches being performed in that very Museum (and in other Florentine Museums) concerning monitoring climate and related deformation of panel paintings.

A second scientific visit took place at the end of the Meeting, on Saturday 10th afternoon, at the OPD (Opificio delle Pietre Dure) Restoration Laboratory. Dr. Marco Ciatti, Director of the Panel paintings Section, showed some masterpieces (including Giotto's Painted Cross, and Raffaello's Madonna del Cardellino) under restoration, and discussed problems being encountered and solutions being worked out.

A Management Committee meeting also took place, divided in two parts, after the scientific sessions.

## 2. Main objectives and results

The main objectives of the Workshop, which have been achieved at a quite satisfactory level, can be summarized as follows:

- a) To present a "state of the art" about selected subjects dealt with by the Action (From the program: "Historic wood – structure and properties", "Wood material – ageing and non-biological degradation", "Assessment & Diagnosis", "Diagnosing the surface of painted wood" "Diagnosing the efficiency of object treatments", "Contributions from Wood Science to conservation issues", "Expressing needs in the field of conservation, of objects and/or monuments, in matter of Wood Science");
- b) To improve mutual knowledge and acquaintance between MC Members, and WG members;
- c) To present current ongoing research, and inform specialists of different fields, all working towards conservation of WCHOs (Wooden Objects belonging to the Cultural Heritage), about the work of their colleagues and the scientific work being carried out in different Institutions;
- d) To provide an opportunity for discussing interdisciplinary subjects, which are very important for study and conservation of WCHOs;
- e) To identify the main subjects to be discussed in forthcoming activities.

In fact this Workshop was instrumental for defining and addressing the future activities of the Action; a very good atmosphere, full of enthusiasm and of availability towards cooperation, emerged, and has been maintained during successive activities.

The previous meeting (in Tervuren) and this one were both organized at short notice, as is normally the case at the beginning of an Action. They allowed interactions between scientists who often met for the first time and exchanges of general information from subjects of other fields. In the plenary meetings which followed, scientific contributions on well-focused subjects have been made possible by the longer time allowed for submission of papers.

In this occasion several topics were also suggested for future general or focused meetings.

## 3. Allocating and refereeing the Papers

For this Workshop, the Steering Committee (see Annex 2) fulfilled the role of Scientific Committee, preparing and managing its scientific aspects, and organising the refereeing process of the submitted papers, all of which have been peer-reviewed for this publication.

Emphasis should be given to the fact that all accepted paper were deemed of high scientific calibre and deserved the same "dignity", no matter whether they were allocated as Oral presentations or Posters, such allocation being dictated by inescapable time constraints.

Unfortunately some Authors were not able to submit their paper for publication; the titles of their presentations can be found in the Programme (Appendix 2). In some cases, the screen presentations they offered can be found on the Action's website <<http://www.woodculther.org>>. Others, not being of English mother tongue, submitted papers with some language inaccuracies; as long as such

inaccuracies did not affect the comprehensibility of the text, the SC decided not to ask for a very strict language editing.

In order to maintain in these Proceedings the same rationale as the Conference structure, the papers were allocated grouped according to the sessions during which they were presented, as follows (see also Annex 1):

- *Session managed by WG1* (Topic 1 “Historic wood – structure and properties”; Topic 2 “Wood material – ageing and non-biological degradation”; Posters relating to WG1 subjects, no oral presentation);
- *Session managed by WG2* (Topic 3 “Diagnosing the surface of painted wood”; Topic 4 “Diagnosing the efficiency of object treatments”; Posters relating to WG2 subjects, no oral presentation);
- *Session managed by WG3* (Topic 5 “Contributions from Wood Science to conservation issues”; Topic 6 “Expressing needs in the field of conservation, of objects and/or monuments, in matter of Wood Science”; Posters relating to WG3 subjects, some with short oral presentation in front of poster, some with no oral presentation);
- *Scientific visit, San Marco Museum.*

Except for indexing, no “judgement of value” is associated with the allocation of papers; some of them were allocated for oral presentation because they were considered as of more general interest for the public, other as posters because of the limited time available.

### **Acknowledgements**

As the Editor of these Proceedings, I wish to deeply and sincerely thank:

- each and all the members of Steering Committee, who accepted to undertake their heavy task;
- the anonymous referees who revised the papers, and provided effective and beneficial comments and suggestions;
- the Authors of the papers, who shared their knowledge and their work, aimed at improving conservation (in Europe and worldwide) of Wooden Cultural Heritage Objects;
- the friends and colleagues who were instrumental in making possible and organizing the Workshop, including the COST Office personnel, Piotr Swiatek (at that time Science Officer, later replaced by Caroline Whelan) and Milena Stoyanova (Administrative Officer), The Action’s Rapporteur Zsolt Kajcsos, the members of the Organizing Committee cited above. A book collecting all the messages between us cannot be published, but would possibly be as bulky as these proceedings, and full of unforeseen findings and introspections.

*Luca Uzielli*  
*Chairman of the Action and Organizer of the Florence Conference*



**SESSION MANAGED BY WG1**



# HISTORICAL WOOD – STRUCTURE AND PROPERTIES

*Thomas Nilsson<sup>1</sup>, Roger Rowell<sup>1,2</sup>*

<sup>1</sup>Faculty of Forest Sciences, SLU, c/o SP Technical Research Institute of Sweden

<sup>2</sup>University of Wisconsin, Madison, WI, USA

## **Abstract**

A short introduction to wood structure is given. Major pathways and chemistries for biotic and abiotic degradation involved in the deterioration of historical wood are described. Preservation and conservation are briefly discussed.

## **1. Introduction**

Wood has been used by humans for thousands of years as tools, fuel, weapons, structures and for recreation. Wooden artefacts remaining from human use not only provide us with an interesting picture of the skills and ingenuity of past generations but also the changes in wood structure tell us a lot about the environment that was present when the wood was in use and the environmental changes in the passage of time.

Wood and wooden artefacts are organic materials and are, therefore, subject to the recycling chemistries of Mother Nature. In broad terms, wood is produced from the basic building blocks of carbon dioxide and water and it is recycled by Nature back to carbon dioxide and water. In order for artefacts to survive from past civilizations, the artefact must survive Nature's recycling chemistries. Many of the historical wood artefacts we have today have undergone some chemical and physical changes. Most of the historical wood artefacts have been lost due to the fragile nature of the material.

To study and understand the changes that wooden artefacts have undergone with the passage of time, changes that may be of vital importance for preservation, it is important to understand the structure and chemistry of wood.

## **2. Understanding Wood**

The study of wood is best done by looking at it at different levels of detail and there are several levels of details to consider: macro, sub-macro, micro, sub-micro, and molecular. We recognize wood at the macro level as a tree and this level can be broken down into two sub-categories, softwood and hardwoods.

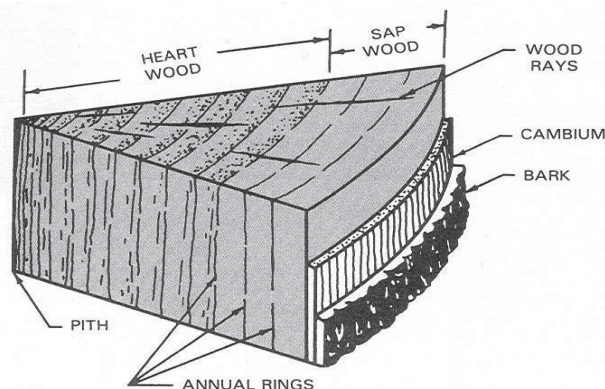



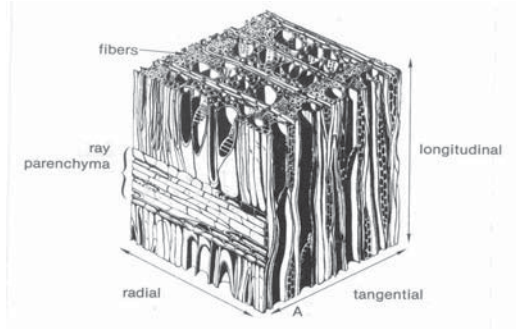
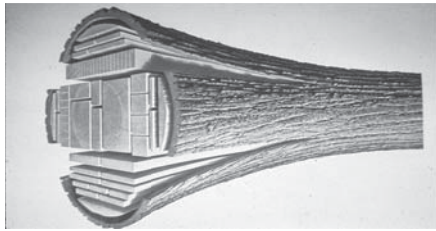

At the sub-macro level, we recognize wood as a solid board (in the rough) or as wood furniture, windows, doors, etc. At the micro level, we study the wood cell wall and identify different elements such as lumens, pits, vessels, ray cells, etc.

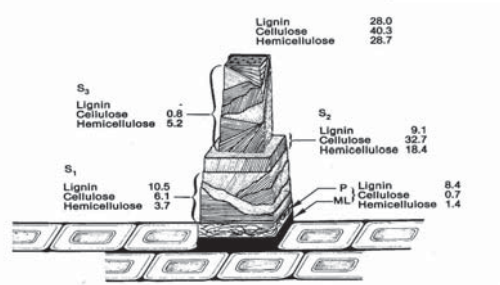
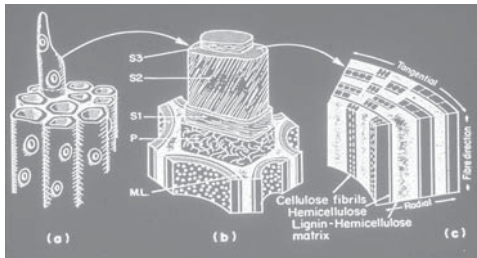

Finally, at the molecular level we can study the cell wall polymers (cellulose, lignin and hemicelluloses) and their building blocks of simple sugars, phenolic units as well as extractives structure and inorganic compounds. We may also detect and quantify substances foreign to natural wood.

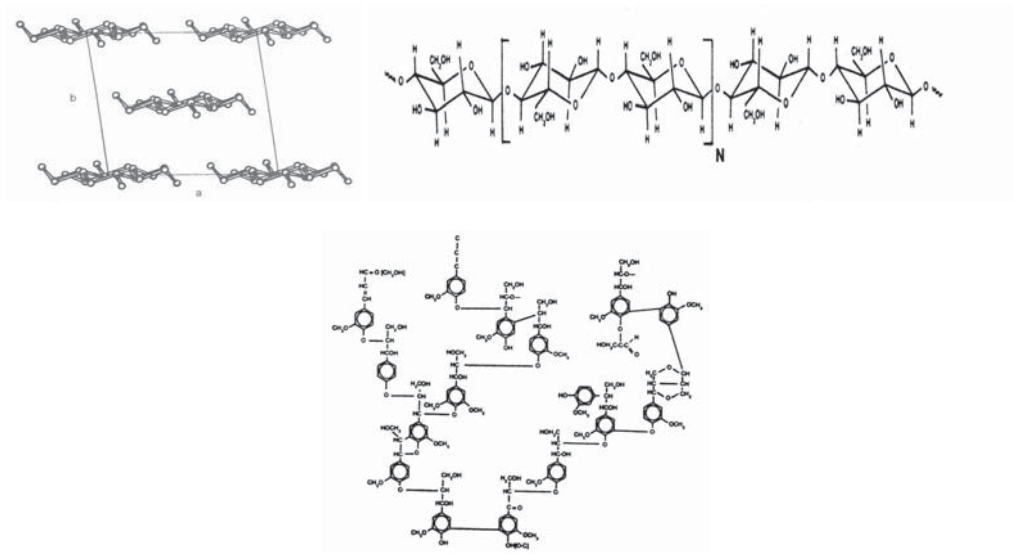

Lignin protects the wood from being degraded by common cellulolytic micro-organisms. This is why wood lasts a lot longer than plain paper. There are two main forms of lignin, guaiacyl and

syringyl lignin. Guaiacyl lignin is more resistant than syringyl lignin to microbial degradation. This explains why softwoods, which almost exclusively contain guaiacyl lignin are more durable than hardwoods, where the lignin is a mixture of guaiacyl and syringyl lignins. Extractives in certain heartwoods increase the durability considerably. Sapwood is always susceptible to decay. Reaction wood, tension and compression wood, has a structure that differs anatomically and chemically from “normal” wood. These differences have to be considered in analyses of historical wood.

For some, the identification of tree species is the level needed to understand wood. For others, types of wood are important to identify a potential product or performance requirement. As you go deeper in to the substructures, you start to understand that ‘wood’ is a very common name for a very complex structure and, at these levels, wood is best understood as a three dimensional biopolymer composite composed of an integrated network of polymers.

There are several major factors that determine if wood will survive over time. One important factor is the chemical structure of wood, which interacts with other major factors such as oxygen, moisture, pH, temperature, ultraviolet energy, micro-organisms and contaminants. Wood that not been exposed to oxygen can survive thousands of years without major changes. Wood that has been kept dry over centuries survives with little change in structure or properties. Without oxygen and moisture, few micro-organisms can survive, and, wood that is free of inorganic salts and other contaminants can also survive with little change. In some cases, the contaminate may, in fact, help in the preservation of a wooden artefact. An ancient tree preserved after being buried in the ash of a long past volcano show us that wood without oxygen survives the passage of time unaffected. Wood from a 10,000 year old tomb in China that was kept dry all the years survived with very little change. Wood from ships recovered from the bottom of lakes and seas is found to be strong and recoverable since it was maintained in a cold water-logged state. A bowl, made from a wood species not native to that region of the world tell us something about the migration of populations. A totem pole from the Alaskan tundra that was kept very cold for hundreds of years can remain brightly colored and sound. A house built from solid timbers will weather very slowly (about 2\3 cm per century) due to ultraviolet energy and rain.

When the degrading elements work together, the wooden artefact is not likely to survive.

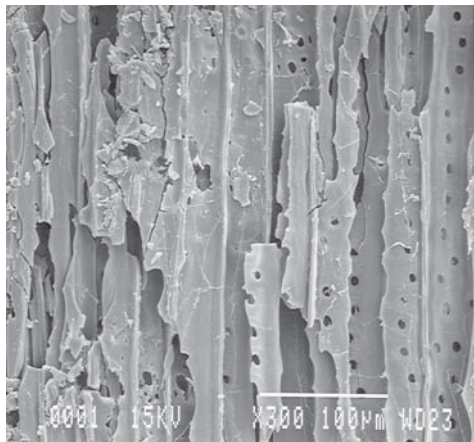

For example, wood above its fiber saturation point (the point where all of the water in the wood is in the cell wall and it can not hold any more), in a warm environment in contact with micro-organisms is not likely to survive more than a few months. The image to the left shows wood that has been attacked by brown-rot fungi and has lost a lot of weight and strength. Wood in contact with limited water and in contact with micro-organisms may survive in a badly degraded state with little strength or cell wall structure remaining.

Wood from a ship may be badly degraded by ocean organisms, like shipworm and *Limnoria*. A wooden tank used to dye cloth may be badly stained and degraded by elements such as iron.

Mother Nature has five basic chemistries to convert a wooden artefact back to carbon dioxide and water. The five chemistries are oxidation, hydrolysis, dehydration, reduction and free radical reactions. Table 1 shows the major degradation pathways and the chemistries involved in those pathways.

The chemistries shown in Table 1 may result in a badly damaged wooden artefact and from the type of degradation it may be possible to distinguish the mechanism of degradation. This analysis may help provide valuable information on a possible conservation treatment for the artefact. A great number of analytical techniques exist and selecting the best suited technique may be a challenge. For some artefacts, analyses should be based on more than one technique, in order to gain a better understanding of the degradation processes. An example: A traditional chemical analysis will tell you that various components have been lost over time, but not the cause of degradation. Microscopy can be used to detect or exclude microbial decay.

Degradation of wood is an irreversible process. Despite various claims, degraded wood cannot be restored to its original state.

Table 1. Major degradation pathways and chemistries.

Biological Degradation	Fungi, Bacteria, Insects, Termites
Enzymatic Reactions	Oxidation, Hydrolysis, Reduction, Free radical
Chemical Reactions	Oxidation, Hydrolysis, Reduction, Free radical
Mechanical	Chewing
Thermal Degradation	Lightning, Fire, Sun
Pyrolysis Reactions	Dehydration, Hydrolysis, Oxidation, Free radical
Water Degradation	Rain, Sea, Ice, Acid Rain, Dew
Water Interactions	Swelling, Shrinking, Freezing, Cracking, Erosion
Weather Degradation	Ultraviolet radiation, Water, Heat,
Chemical Reactions	Oxidation, Hydrolysis, Free radical
Mechanical	Erosion
Chemical Degradation	Acids, Bases, Salts, Iron, Oxygen
Reactions	Oxidation, Reduction, Dehydration, Hydrolysis, Free radical
Mechanical Degradation	Dust, Wind, Hail, Snow, Sand
Mechanical	Stress, Cracks, Fracture, Abrasion, Erosion, Compression

### 3. Preservation and Conservation

Preservation *in situ* or reburial requires knowledge of the actual structure and durability of the wood and biological factors that may contribute to further degradation and the environmental factors. Here, cooperation between wood scientists, wood biologists and conservators is required. For large structures precautions must be taken to avoid mechanical damage. In certain situations the deteriorating factors can be monitored by installing fresh wood to the historical wood. It is extremely difficult to assess further deterioration in wood that already is decayed.

Once the historical wood has been recovered from its environment, it becomes a question on how to preserve or conserve the artefact. Some method is needed to restore or stabilize the artefact from further degradation. Analyses of the wood before conservation will help to improve the conservation. They will also provide facts of importance for the selection of the most suitable environment for future storage. Size and weight after treatment decides if supportive structures are required. Here the mechanical strength of the conserved wood has to be estimated. Long term effects, such as creep and cell collapse, have to be taken into account.

In the case of badly degraded artefacts where cell wall structure is damaged and the strength is very low, the method of restoration might be to impregnate the wood with an epoxy resin or an acrylic monomer that is later polymerized.

### 4. Storage

Once the restoration or stabilization is complete, the next concern is how to store the artefact. Should it be kept wet, dry, cold, out of sunlight, etc. The recent problems relating to sulphur and iron in the Vasa timbers, demonstrate that we need a lot more knowledge for designing optimal storage conditions.

## References

1. Blanchette, R.A. (2000): A review of microbial deterioration found in archaeological wood from different environments. *International Biodeterioration & Biodegradation*, 46, 189-204.
2. Eaton, R.A. and Hale, M.D.C. (1993): "Wood. Decay, pests and protection". Chapman & Hall, London.
3. Panshin, A.J. and de Zeeuw, C. (1980): "Textbook of Wood Technology. Structure, Identification, Properties, and Uses of the Commercial Woods of the United States and Canada". 4th Edition. McGraw\_Hill Book Company.
4. Rowell, R.M., and J. Barbour, eds. (1990): "Archaeological Wood: Properties, Chemistry, and Preservation". American Chemical Society Advances in Chemistry Series 225, Washington, DC, 472 pp.
5. Rowell, R.M. ed. (2005): "Handbook of Wood Chemistry and Wood Composites", Taylor and Francis, Boca Raton, FL, 487 pp.

# EFFECTS OF AGEING AND HEATING ON THE MECHANICAL PROPERTIES OF WOOD

*Eiichi Obataya*

Graduate School of Life and Environmental Sciences, University of Tsukuba, Japan  
obataya@sakura.cc.tsukuba.ac.jp

## Abstract

The experiments conducted by Kohara in the 1950s are introduced to understand the mechanical properties of aged wood. The results indicate that the stiffness, strength and the dimensional stability of wood improve slightly during hundreds years of ageing, while its ductility and shear strength degrade significantly. These changes are attributed to the chemical changes in wood constituents such as the crystallization of cellulose and the depolymerization of hemicelluloses. The ageing-like effects of heating are also discussed. The heat-treated wood are very similar to aged wood with respect to its fragile nature and improved stability. However, different effects of dry heating (oven heating) and steaming suggest that careful moisture conditioning is required for 'true' acceleration of ageing. In addition, reversible changes in the hygroscopicity of heat-treated wood imply the physical ageing of wood polymers by dry heating.

## 1. Introduction

In Japan, a lot of wooden constructions have been well preserved over a thousand years. Their beautiful appearance show that wood remains incredibly durable when it is appropriately maintained and protected from weathering and biological attacks. Thus, the dark-colored aged wood is regarded as a venerable object that reminds us of its long history involved. Aged wood is also venerated by musicians and artisans. It is believed that ageing improves the stiffness and stability of wood, and therefore, quality instruments are usually made using aged wood. In this case, ageing is not a negative senescence but a positive treatment to increase the value of wood.

The reduced strength of aged wood should be taken into account for the appropriate maintenance of old wooden constructions. Meanwhile, its improved stiffness and stability suggest the possibility of heat treatment i.e. artificial ageing as a method of property enhancement of wood. In this paper, the effects of ageing and heating on wood properties are surveyed for clear understanding of their advantages and disadvantages.

## 2. Effects of ageing on wood properties

In the 1950s, Jiro Kohara tested the chemical and mechanical properties of several hundreds of aged wood samples obtained from ancient temples [1-6]. It should be noted that the timbers for temples were usually harvested from special forests, carefully dried and strictly classified. In addition, such religious constructions have been well maintained and protected from war, fire, earthquake and weathering. Consequently, various negative influences of defects (irregular grain, stain, etc.) could be excluded from the considerations in Kohara's study.

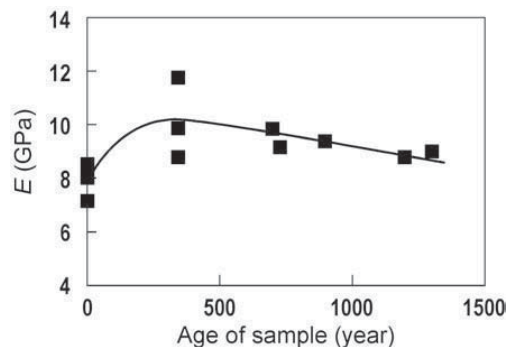

Fig. 1. Effects of prolonged ageing on the bending Young's modulus ( $E$ ) of cypress wood.

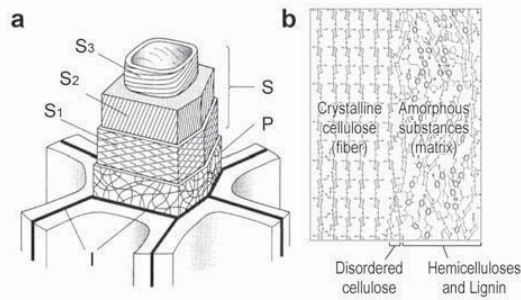

Fig. 2. Cellular structure of wood (a) and fiber-matrix composite structure in the wood cell wall (b).

Figure 1 shows the changes in bending Young's modulus ( $E$ ) over 1300 years. The  $E$  value increased in the first 300 years and then gradually decreased. Similar trend was found in bending strength, compressive strength and hardness of wood. These results prove that the wood is incredibly durable when it is appropriately maintained. According to Kohara, the slight stiffness increase in the first 300 years reflects the crystallization of cellulose. As shown in Figure 2, the wood cell wall is a fiber-reinforced composite in which the crystalline cellulose 'fibers' are embedded in an amorphous 'matrix' of hemicelluloses and lignin. A part of disordered (amorphous) cellulose is fairly oriented along the fiber axis, and therefore, it is readily crystallized by thermal activation. Since the stiffness of crystalline cellulose (ca.130GPa) is much greater than that of the matrix substances (at most 8GPa), the crystallization of disordered cellulose results in greater stiffness of wood, unless the fiber-matrix cohesion is weakened.

Prolonged ageing is not always favorable for the practical performances of wood. Figure 3 shows the absorbed energy in impact bending ( $AE$ ) of aged wood. The considerable reduction in the  $AE$  value indicates that the wood becomes fragile by ageing. Similar negative effect was also recognized in shear strength and cleavage resistance. The fragility of aged wood is attributable to the depolymerization of hemicelluloses. Among the matrix substances, hemicelluloses are particularly important for tight cohesion between the fiber and the matrix, and the fiber-matrix cohesion is necessary for the ductility and rigidity of the composite. Thus it is natural that the wood becomes fragile when the fiber-matrix cohesion is weakened by the degradation and the loss of hemicelluloses. Actually, the results of chemical analysis has suggested that a part of amorphous polysaccharides were gradually depolymerized into water- and alkali-soluble extractives during ageing, while the degradation of lignin was relatively slow. Interestingly, the chemical degradation in cypress wood (*Chamaecyparis obtusa*) was clearly slower than that in zelkova wood (*Zelkova serrata*). With respect to the chemical stability of wood constituents, it is logical that ancient Japanese architects and artists have preferred the cypress wood for their buildings and sculptures.

Figure 4 shows the maximum tangential shrinkage of aged wood. The smaller shrinkage of aged wood indicates its improved dimensional stability. Such a stabilization effect can be explained by the decomposition and loss of hygroscopic hemicelluloses as well as the crystallization of cellulose.

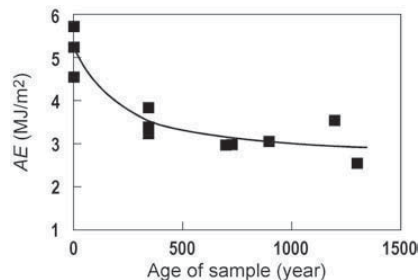

Fig. 3. Absorbed energy in impact bending ( $AE$ ) of cypress wood as a function of ageing period.

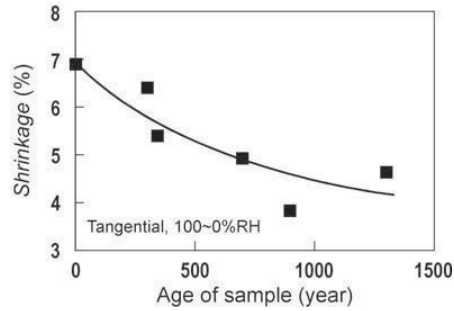

Fig. 4. Effects of ageing on the tangential shrinkage of wood.

### 3. Effects of heating on wood properties

#### 3.1 Ageing and heating

In general, the strength of wood is reduced by heating mainly due to the decomposition of hemicelluloses [7–10]. The stiffness of wood is also reduced by long-term heating, but it often shows a slight increase at the initial stage of heating. Such a stiffening is explained by the reduced hygroscopicity [10,11] and crystallization of cellulose [12]. All these changes are qualitatively similar to those resulted from ageing, therefore, the heating is sometimes regarded as ‘accelerated ageing’.

In general, the strength of wood is reduced by heating mainly due to the decomposition of hemicelluloses [7–10]. The stiffness of wood is also reduced by long-term heating, but it often shows a slight increase at the initial stage of heating. Such a stiffening is explained by the reduced hygroscopicity [10,11] and crystallization of cellulose [12]. All these changes are qualitatively similar to those resulted from ageing, therefore, the heating is sometimes regarded as ‘accelerated ageing’. In Figure 5, the time for 5% loss in weight (WL) due to heating is plotted against the reciprocal of heating temperature ( $1/T$ ) [7,10,13,16]. In ‘dry heating’, the wood is first dried and then heated in the absence of moisture (0%RH) whereas in ‘steaming’, the wood is heated in saturated water vapor (100%RH). The steaming always results in faster degradation than dry heating because the hydrolysis of cellulose and hemicelluloses are remarkably accelerated in the presence of moisture [8,13–16]. This fact indicates that the thermal degradation of wood is very sensitive to the moisture condition. In addition, it has been suggested that the effects of dry heating and steaming are qualitatively different, as described later. Therefore, it is still difficult to realize the ‘true’ acceleration of ageing, i.e. complete reproduction of aged wood by short-term heating, because no sufficient data is available for moderate RH range (20~90%RH) where natural ageing proceeds.

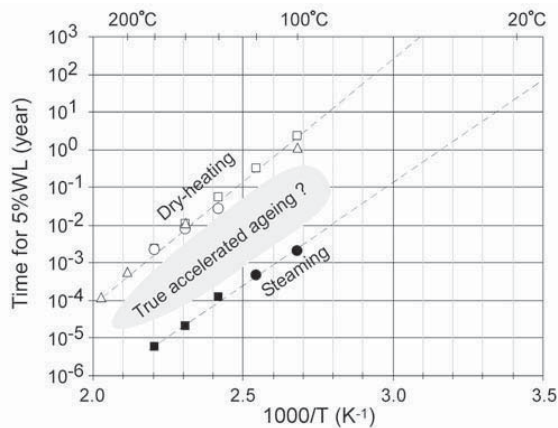

Fig. 5. Time for 5% loss in weight (WL) due to heating plotted against the reciprocal of heating temperature ( $1/T$ ).  $\square\triangle\circ$ , Dry heating [7,13,16];  $\blacksquare\bullet$ , steaming [10,16].

### 3.2 Mechanical properties of heat-treated wood

Figure 6 shows the changes in strength of wood due to dry heating (115°-175°C) and steaming (80°-120°C) as a function of loss in weight (WL) [7,10]. The significant reduction in strength can be explained by the depolymerization and loss of hemicelluloses. The steaming also reduces the maximum tensile strain [10]. In Figure 7, the relative bending Young's modulus ( $E$ ) of heat-treated wood is plotted against the WL. The  $E$  value increases up to 1-2%WL and then drops with an increase of WL. The slight increase in the stiffness is attributed to the reduction in hygroscopicity rather than the crystallization of cellulose. All those results indicate that wood is weakened by heating as a whole.

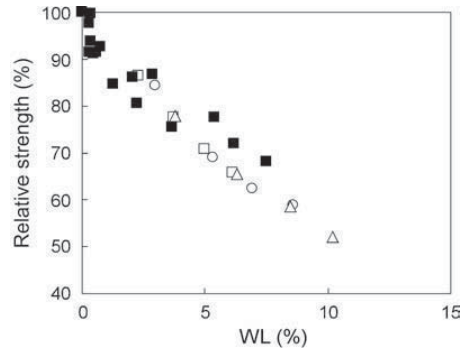

Fig. 6. Relative strength of dry-heated (□△○) and steamed (■) wood plotted against the loss in weight (WL) due to heating.

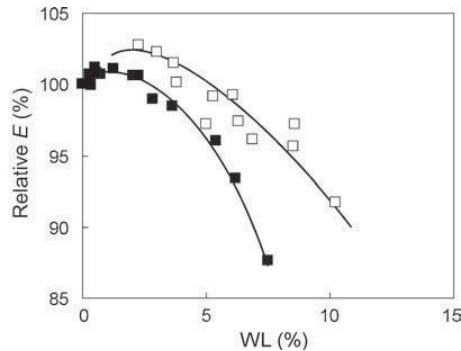

Fig. 7. Relative bending Young's modulus ( $E$ ) of dry-heated (□) and steamed (■) wood as a function of WL.

### 3.3 Hygroscopicity of heat-treated wood

The most advantageous effect of heating is the reduction in hygroscopicity. improves dimensional stability wood against humidity change. In addition, various moisture-dependent properties of wood are indirectly stabilized with the reduction in hygroscopicity. These are the reasons why many researchers have dealt with the ageing-like effects of heating effective stabilization of wood. In Figure 8, equilibrium moisture content ( $M$ ) of heat-treated wood is plotted against the WL [16]. In this case, the water-soluble extractives have been removed prior to the hygroscopicity measurements. At 33%RH, no difference is observed between the effects of dry heating and steaming. On the other hand, the  $M$  value of dry-heated wood is always smaller than that of steamed wood at 97%RH. This fact indicates that the effects of dry heating and steaming are qualitatively different.



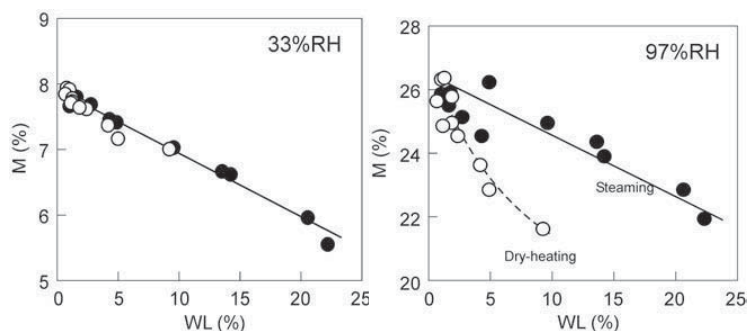

Fig. 8. Equilibrium moisture content (M) of dry-heated (○) and steamed (●) wood as a function of WL.

In Figure 8, equilibrium moisture content (M) of heat-treated wood is plotted against the WL [16]. In this case, the water-soluble extractives have been removed prior to the hygroscopicity measurements. At 33MarchRH, no difference is observed between the effects of dry heating and steaming. On the other hand, the M value of dry-heated wood is always smaller than that of steamed wood at 97MarchRH. This fact indicates that the effects of dry heating and steaming are qualitatively different.

The reduced hygroscopicity of heat-treated wood is often explained by the decomposition of hygroscopic hemicelluloses and the condensation or polymerization of the other carbohydrates [14]. If this is the case, the hygroscopicity of wood should be effectively reduced by steaming rather than dry heating because the decomposition of hemicelluloses and the crystallization of cellulose are accelerated in the presence of moisture [8,13-17]. However, the experimental results do not meet this expectation.

When the adsorbed water is separated into hydrated water (Mh) and dissolved water (Ms) by using Hailwood-Horrobin adsorption equation [18], different effects of dry heating and steaming are characterized by the amount of Ms: the reduction in Ms due to dry heating is much greater than that due to steaming, while the Mh decreases linearly with increasing WL regardless of heating methods. These facts imply that large-scale conformational changes in the wood polymers affect the hygroscopicity of heat-treated wood. During dry heating, various chemical changes such as depolymerization, condensation and crystallization proceed in a 'shrunk' state wherein the intermolecular spacing is minimized. Although the formation of ether cross links has been disproved by an early investigation [19], the condensation of lignin and the formation of strong hydrogen bonds (so-called hornification) possibly restricts the swelling of wood. On the contrary, such a tight structure cannot be formed during steaming because the chemical changes occur in the 'swollen' state wherein the intermolecular spacing is maximized with adsorbed water. Consequently, the Ms is not significantly reduced by steaming, whereas it is effectively reduced by dry heating. These speculations are supported by the changes in volumetric swelling of heat-treated wood in various solvents: the dry-heated wood always shows smaller swelling than the steamed wood at the same WL [16].

### 3.4 Reversible changes in hygroscopicity of heat-treated wood

The effects of heating are usually explained by irreversible chemical changes such as hydrolysis, condensation and crystallization in the wood constituents. If so, the hygroscopicity of heat-treated wood should remain unchanged by any after-treatments involving no chemical changes.

Figure 9 shows the equilibrium moisture content (M) of dry-heated wood plotted against the WL [20]. The M of wood remains unchanged by repeating measurements at 97%RH (2"4), but it shows a significant recovery at 57%RH (1"3). This suggests that the effect of dry heating is partly reversible, and such a temporary effect disappears by moistening at high RHs.

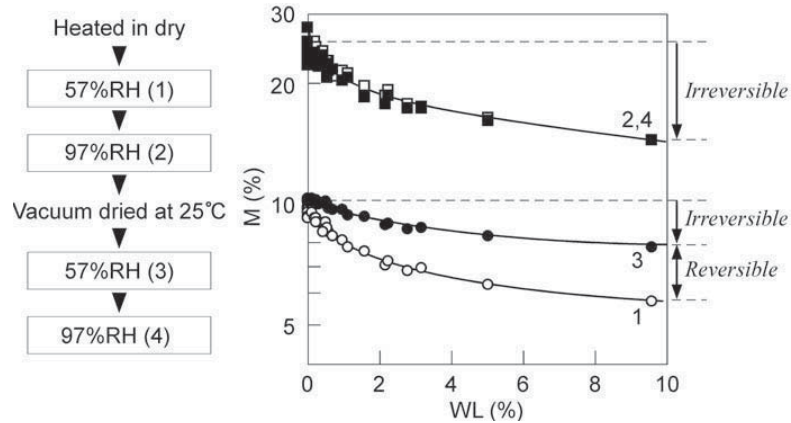

Fig. 9. Reversible changes in equilibrium moisture content (M) of dry-heated wood.

A possible interpretation of the reversible effects of dry heating is the annealing or the physical ageing of wood polymers. Figure 10 illustrates a simplified model of wood consisting of an amorphous viscoelastic part (a), adsorbed moisture (b) and a rigid hydrophobic part (c). During the drying of wood from its natural green state (A), some stress or strain occurs in the amorphous part because its shrinkage is restricted by the rigid hydrophobic part. Such a distortion remains unrecovered in the dry condition because the mobility of amorphous molecules is very low (B). However, the amorphous part becomes mobile with moisture sorption (C) and it recovers its initial 'natural' state in humid condition (D). On dry heating, a part of the remaining stress is relaxed with the thermal activation of amorphous polymers (E), and such a stabilized structure restricts the moisture sorption at low RH (F). At high RH, however, the amorphous molecules recover their initial state as their mobility increases (G).

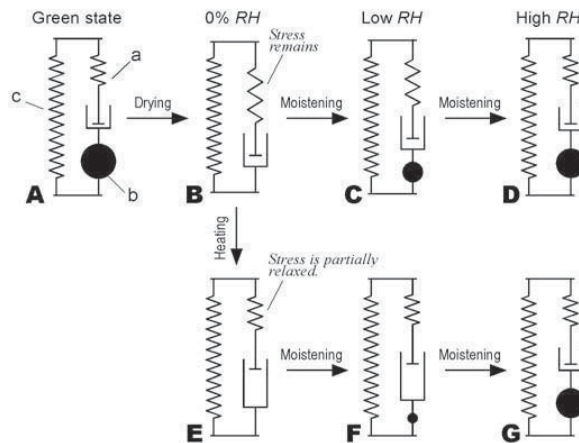

Fig. 10. An interpretation of the reversible changes in the hygroscopicity of heat-treated wood.

When a dry wood is aged in a constant humidity condition, wood polymers can hardly be rearranged because they are kept in a glassy state and are almost 'frozen'. However, real ageing proceeds under humidity fluctuations involving alternate swelling and shrinkage of amorphous wood polymers. Such an annealing-like effect of ageing might be a reason for the improved stability of aged wood. Unfortunately no investigation has so far been made on the reversibility of ageing effects.

#### 4. Conclusions

Prolonged ageing improves the bending Young's modulus, bending strength, compressive strength and hardness of wood, but it significantly reduces the absorbed energy in impact bending, shear strength and cleavage resistance of wood. These results indicate that the wood becomes stiffer and harder but less ductile during ageing. These changes are attributable to the chemical changes in wood constituents such as the crystallization of cellulose and the depolymerization of hemicelluloses. With respect to the fragility and improved stability, heat-treated wood is similar to the aged wood. However, appropriate moisture conditioning is necessary for 'true' acceleration of ageing because the effects of dry heating and steaming are qualitatively different.

#### References

1. Kohara, J. (1952): Studies on the durability of wood I, mechanical properties of old timbers (in Japanese). Bulletin of Kyoto Prefectural University Vol. 2: 116-131.
2. Kohara, J. (1953): Studies on the permanence of wood V, shrinkage and swelling of old timbers about 300-1300 years ago (in Japanese). Bulletin of Kyoto Prefectural University Vol. 5: 81-88.
3. Kohara, J. (1954): Studies on the permanence of wood VI, the changes of mechanical properties of old timbers (in Japanese). Bulletin of Kyoto Prefectural University Vol. 6: 164-174.
4. Kohara, J. (1954): Studies on the permanence of wood VII, the influence of age on the components of wood (*Chamaecyparis obtusa* Endlicher) (in Japanese). Bulletin of Kyoto Prefectural University Vol. 6: 175-182.
5. Kohara, J. (1955): Studies on the permanence of wood XV, the influence of age on the components of wood (*Zelkova serrata* Makino) (in Japanese). Mokuzai Gakkaishi 1: 21-24.
6. Kohara, J. (1955): On permanence of wood II, differences between the ageing processes of cypress wood and zelkova wood (in Japanese). Wood industry 10: 395-399.
7. Millett, M.A., and Gerhards, C.C. (1972): Accelerated aging: Residual weight and flexural properties of wood heated in air at 115° to 175°C. Wood Science 4: 193-201.
8. Hillis, W.E. (1984): High temperature and chemical effects on wood stability. Part 1: General considerations. Wood Sci. Technol. 18: 281-293.
9. Green, D.W., Evans, J.W., and Craig, B.A. (2003): Durability of structural lumber products at high temperatures. Part I. 66°C at 75%RH and 82°C at 30%RH. Wood Fiber Sci. 35: 499-523.
10. Obataya, E., Shibutani S., Hanata, K, and Doi, S. (2006): Effects of high temperature kiln drying on the practical performances of Japanese cedar wood II : changes in mechanical properties due to heating. J. Wood Sci. 52: 111-114.
11. Obataya, E., Norimoto, M., and Tomita, B. (2000): Moisture dependence of vibrational properties of heat-treated wood (in Japanese): Mokuzai Gakkaishi 46: 88-94.
12. Kubojima, Y., Okano T., and Ohta M. (1998): Vibrational properties of Sitka spruce heat-treated in nitrogen gas. J. Wood Sci. 44: 73-77.
13. Stamm, A.J. (1956): Thermal degradation of wood and cellulose. Ind. Eng. Chem. 48: 413-417.
14. Mitchell, R.L., Seborg, R.M., and Millett, M.A. (1953): Effect of heat on the properties and chemical composition of Douglas-fir wood and its major components. J. Forest Prod. Res. Soc. 3: 38-42, 72-73.
15. Kubinsky, E., and Ifju, G. (1973): Influence of steaming on the properties of red oak. Part I. Structural and chemical changes. Wood Sci. 6: 87-94.
16. Obataya, E., Higashihara T., and Tomita B. (2002): Hygroscopicity of heat-treated wood III. effects of steaming on the hygroscopicity of wood (in Japanese). Mokuzai Gakkaishi 48: 348-355.
17. Bhuiyan, M.T.R., Hirai N., and Sobue N. (2000) Changes of crystallinity in wood cellulose by heat treatment under dried and moist conditions. J. Wood Sci. 46: 431-436.
18. Hailwood, A.J., and Horrobin, S. (1946): Absorption of water by polymers: analysis in terms of a simple model. Trans. Farad. Soc. 42B: 84-92.
19. Seborg, R.M., Tarkow, H., and Stamm, A.J. (1953): Effect of heat upon the dimensional stabilization of wood. J. Forest Prod. Res. Soc. 3: 59-67.

20. Obataya, E., and Tomita B. (2002): Hygroscopicity of heat-treated wood II. Reversible and irreversible reductions in the hygroscopicity of wood due to heating (in Japanese). *Mokuzai Gakkaishi* 48: 288-295.

# DETECTION AND EARLY IDENTIFICATION OF DECAY FUNGI: FROM STANDING TREES TO WOOD SUBSTRATES

Nicola Luchi, Paolo Capretti, Aniello Scala

Department of Agricultural Biotechnology, University of Florence, Florence, Italy  
nicola.luchi@unifi.it

## Abstract

Some molecular techniques based on DNA and useful for the detection and identification of fungi in wood substrates are described. These techniques are faster and more reliable than conventional methods, and in the last few years several protocols have been developed to detect fungi in standing trees. In addition, these new methods can detect small amounts of fungal DNA in complex matrices, detecting both individual fungal species and specific taxa. These DNA-based methods have an interesting application in preventing wood damage, especially when they are used at an early stage of fungal colonization.

## 1. Introduction

Fungal communities consist in part of pathogenic micro-organisms that cause plant diseases and wood degradation. In most cases conventional methods are used to detect these pathogens inside the trees. Conventional methods consist in recording visual symptoms, collecting putative infected samples, isolating fungal colonies on culture media, and identifying the causal micro-organisms involved. These approaches tend to be time-consuming and their accuracy depends to a large extent on the expertise of the person making the diagnosis [2].

Over the last few years, new diagnostic methods have been developed to detect fungal organisms colonizing plant and wood tissue. These new methods are mainly based on the detection of fungal DNA in a complex matrices such as plant tissues. Most of these techniques are already well established in clinical research, but they are now becoming accessible from an economic point of view to plant biology as well.

These methods have proved useful for fungal detection on:

a) *Standing trees*. Some Authors have applied these methods to the identification of fungal species, particularly those that cause decay on standing trees. The identification of these species is often a complicated task requiring previous experience in interpreting visual symptoms or signs, or in identifying particular fruit bodies. Molecular tools can be very useful for this purpose. Terho *et al.* [16] developed primers to identify *Ganoderma* species collected in an urban environment. Other studies describe DNA-based methods that detect fungi directly in the wood. Guglielmo *et al.* [5] designed primers that detect wood decay fungi directly in wood sampled from standing trees.

b) *Wood timber*. Specific markers were designed to identify *Serpula lacrymans*, a fungus that causes serious wood rot. The rapid detection of this fungus reduces the risk of rot developing in the wood [7] (Table 1).

DNA-based methods are very fast and sensitive and they detect minute quantities of pathogen DNA from samples having only traces of degradation, or no symptoms at all [9,11]. (Table 1). They are therefore useful in detecting fungal occurrence in:

a) *Objects of artistic value*. These methods require only very small samples, including wood fragments; they can therefore be applied in surveys of objects having high artistic importance, such as wooden tablets, picture frames, or canvases that could be subject to fungal degradation [3]. For example, *Alternaria* spp. is an important rot agent [3]. Specific primers have been developed to detect this fungus (Table 1) [8].

b) *Sawdust and pulpwood*. Decay in cut pulpwood is mainly caused by rot fungi, with temperature, moisture and oxygen common environmental factors that influence the rate of wood rot. *Penicillium*, *Fusarium*, and *Trichoderma* are the main fungal genera causing the biodeterioration of pulpwood (Table 1).

Since the DNA molecular techniques are sensitive, rapid and accurate, they can detect and identify specific fungal micro-organisms at an early stage of their colonization, so that damage can be prevented before it has a chance to occur.

## 2. Methods

In all the samples mentioned above, DNA was extracted following the procedure described below. Small sample pieces (ca. 50 mg) were collected from putative infected material, placed in microfuge tubes (2.5 ml) and stored at -20°C until use. Samples were then transferred to 2 ml microfuge tubes with two tungsten beads after mechanical homogenization using a Mixer Mill 300 (Qiagen, Hilden, Germany). DNA was extracted from the samples using the DNeasy Plant Minikit (Qiagen), according to manufacturer's instructions.

After DNA extraction the template was processed using PCR (polymerase chain reaction) for fungal identification, which was performed in one of two ways:

a) DNA was identified using taxon-specific primers [5,10] or species-specific primers [9,11]. This method identifies either a large number of micro-organisms included in a taxon, or a specific micro-organism at the level of single species.

b) DNA was extracted from wood samples and amplified using universal primers specific to the ITS of fungal rDNA. The PCR products were analyzed using electrophoretic gel and sequenced [7]. Sequences were compared with those in the GenBank database of nucleic acid sequences using the BLAST program [1].

## 3. Conclusions

The molecular detection of fungi is having a huge impact in several branches of research, especially those studying diseases in standing trees. During the last few years the use made of molecular techniques has improved the monitoring of fungi in complex matrices, including timber. Unlike conventional approaches, the molecular techniques require only small plugs of wood, minimizing the amount of material to be excised. DNA can be extracted from the samples with a fast DNA preparation kit, considerably speeding up the time needed for processing.

Fungi can be detected using taxon-specific primers, or species-specific primers when fungi in a designated wood target must be detected [5,14]. Alternatively, DNA can be sequenced from wood samples to detect the fungi colonizing them. The sequences obtained identify the fungi by comparing them with the sequences in GenBank. In this way it is possible to vary the specificity fungal detection, from a specific fungus to a broader range of fungi.

Molecular methods based on PCR can detect small amounts of fungal DNA in sample tissue, this enables them to detect fungi at an early stage of colonization [9,10]. They can also predict the severity and the evolution of wood decay, including that caused by indoor rot basidiomycetes. Accurate identification during the initial stages of fungal colonization can prevent damage to historically and culturally important material. In conclusion the molecular tools here described allow the monitoring of microbial colonization, suggesting what treatments are appropriate, and when, before the damage from a fungus has a chance to become irreversible.

## References

1. Altschul, S.F., Madden, T.L., Schaffer, A.A., Zhang, J., Zhang, Z., Miller, W.W. and Lipman, D.J. (1997): Gapped BLAST and PSI-BLAST: A new generation of protein database search programs. *Nucleic Acids Res.* 25:3389-3402.
2. Atkins, S.D. and Clark, I.M. (2004): Fungal molecular diagnostics: a mini review. *J. Appl. Genet.* 45 (1): 3-15.
3. Ciferri, O. (1999): Microbial Degradation of Paintings. *Appl. Env. Micr.* 65(3): 879-885.
4. Demeke, T., M.C., Randy, Patrick, S.K., Gaba, D. (2005): Species-specific PCR-based assays for the detection of *Fusarium* species and a comparison with the whole seed agar plate method and trichothecene analysis. *Int. J. Food Microb.*103: 271- 284.
5. Guglielmo, F., Bergemann, S.E., Gonthier, P., Nicolotti, G. and Garbelotto, M. (2007): A multiplex PCR-based method for the detection and early identification of wood rotting fungi in standing trees . *J. Appl. Microb.* 1-17.
6. Guo, L.D., Huang, G.R., Wang, Y., He, W.H., W.H., Zheng, and Hyde, K.D.(2003): Molecular identification of white morphotype strains of endophytic fungi from *Pinus tabulaeformis*. *Mycol. Res.* 107 (6): 680-688.

7. Hogberg, N. and Land, C.J. (2004): Identification of *Serpula lacrymans* and other decay fungi in construction timber by sequencing of ribosomal DNA. A practical approach. *Holzforschung* 58:199-204.
8. Konstantinova, P., Bonants, P.J.M., van Gent-Pelzer, M.P.E., van der Zouwen, P. and R.van den Bulk (2002): Development of specific primers for detection and identification of *Alternaria* spp. in carrot material by PCR and comparison with blotter and plating assays. *Mycol. Res.* 106 (1) : 23-33.
9. Luchi, N., Capretti, P., Pinzani, P., Orlando, C. and Pazzagli, M. (2005a): Real – time PCR detection of *Biscogniauxia mediterranea* in symptomless oak tissue. *Lett. Appl. Microb.* 41: 61-68.
10. Luchi, N., Capretti, P., Surico, G., Orlando, C., Pazzagli, M. and Pinzani, P. (2005b): - A real-time quantitative PCR assay for the detection of *Sphaeropsis sapinea* from inoculated *Pinus nigra* shoots. *J Phytopath.* 153: 37-42.
11. Luchi, N., Capretti, P., Pinzani, P. and Pazzagli, M. (2006): Early detection of *Biscogniauxia nummularia* in symptomless European beech (*Fagus sylvatica* L.) by TaqMan™ real-time PCR. *Lett. Appl. Microb.* 43: 33-38.
12. Pianzola, M. J., Moscatelli, M., and Vero, S. (2004): Characterization of *Penicillium* isolates associated with blue mold on apple in Uruguay. *Plant Disease.* 88(1): 23-28.
13. Rubio, M.B., Hermosa, M.R., Keck, E. and Monte, E. (2005) Specific PCR assays for the detection and quantification of DNA from the biocontrol strain *Trichoderma harzianum* 2413 in soil, *Microb. Ecol.* 49:25-33.
14. Schmidt, O. and Moreth, U. (2000): Species-specific PCR primers in the rDNA-ITS region as a diagnostic tool for *Serpula lacrymans*. *Mycol. Res.* 14 (1) : 69-72.
15. Schweigkofler, W., Orosina, W. J., Smith, S.L., Cluck, D.R., Maeda, K., Peay, K.G. and Garbelotto M. (2005): Detection and quantification of *Leptographium wageneri*, the cause of black-stain root disease, from bark beetles (Coleoptera: Scolytidae) in Northern California using regular and real-time PCR. *Can. J. For. Res.* 35: 1798-1808.
16. Terho, M., Hantula, J. and Hallaksela, A.M. (2007): Occurrence and decay patterns of common wood-decay fungi in hazardous trees felled in the Helsinki City. *For. Path.* 37: 420-432.

Table 1: Examples of some molecular DNA-based methods to detect fungi on plants and woody substrates. ITS = Internal Transcribed Spacer ; nuc LSU= nuclear large subunit rRNA; mt SSU = mitochondrial small subunit; ssrRNA= Small subunit ribosomal RNA.

Target material	Damage caused	Fungus	Main host	DNA Region	Detection method	Reference
Standing trees/ timber	Rot	<i>Armillaria</i> spp.	Hardwood	ITS2	Taxon-specific primers	Guglielmo <i>et al.</i> (2007)
		<i>Ganoderma</i> spp.		ITS1		
		<i>Inonotus</i> spp.		nuc LSU		
		<i>Laetiporus</i> spp.		nuc LSU		
		<i>Trametes</i> spp.		mt SSU		
		<i>Schizophyllum</i> spp.		ITS2		
	Rot	<i>Ganoderma lipsiense</i>	<i>Acer, Tilia, Fagus</i>	ITS 1	Sequencing	Terho <i>et al.</i> (2007)
		<i>Ganoderma adpersum</i>	<i>Ulmus, Laurus, Morus</i>			
		<i>Ganoderma resinaceum</i>	<i>Quercus</i>			
		<i>Ustulina deusta</i>	Hardwood			
Canker stain	<i>Biscogniauxia mediterranea</i>	<i>Quercus</i> sp.	Sequencing	Species-specific primers	Luchi <i>et al.</i> (2005b)	
	<i>Biscogniauxia nummularia</i>	<i>Fagus sylvatica</i>				
Blue canker stain	<i>Diplodia</i> spp.	<i>Pinus</i> sp.	ss rRNA	Taxon-specific primers	Luchi <i>et al.</i> (2005b)	
	<i>Botryosphaeria</i> spp.	<i>Pinus</i> sp., <i>Vitis</i>				
	<i>Leptographium</i> spp.	<i>Pinus</i> sp.				
Timber	Rot	<i>Serpula lacrymans</i>		ITS 1	Species-specific primers	Schmidt & Moreth (2000)
		<i>Serpula himantioides</i>				
Objects of artistic value	Stain/wood degradation	<i>Alternaria</i> spp.		ITS	Species-specific primers	Konstantinova <i>et al.</i> (2002)
Sawdust and pulp wood	Wood degradation	<i>Penicillium</i> spp.		ITS	Sequencing	Pianzola <i>et al.</i> (2004)
		<i>Trichoderma</i> spp.		-	Species-specific primers	Rubio <i>et al.</i> (2005)
		<i>Fusarium</i> spp.		ITS	Species-specific primers	Demeke <i>et al.</i> (2005)



# DEGRADATION MECHANISMS OF WATERLOGGED ARCHAEOLOGICAL PINE TIMBERS FROM NORTHERN GREECE

Maria D. Petrou, Rob C. Janaway, Gill B. Thompson, Andrew S. Wilson

Division of Archaeological, Geographical and Environmental Sciences, University of Bradford,  
UK  
petroumar@yahoo.gr

## Abstract

Recent archaeological investigations in an intra-montane Mediterranean lake basin in northern Greece, Lake Cheimaditis revealed archaeological deposits with waterlogged archaeological wood. Three wooden posts preserved were investigated to determine the type of wood used in constructions and obtain information on the degradation processes that have occurred in the wood over the past millennia. Test pieces were observed using light microscopy and the preservation state was characterised through density measurements and SEM microscopy. The wooden posts were identified as *Pinus* sp. The density and ultrastructure study indicated advanced degradation associated with elevated microbial activity. This material has highlighted the use of natural resources in the Neolithic northern Greece.

## 1. Introduction

The past five years, archaeological excavations in the intra-montane Mediterranean wetland area of Cheimaditida in northern Greece identified and revealed several areas with archaeological interest. Several areas with archaeological interest have been classified in the broad locale of Cheimaditis. The anoxic waterlogged deposits on the shore of Lake Cheimaditis (Macedonia) revealed well preserved waterlogged ligno-cellulosic material. These sites provide a vast amount of unique archaeological evidence carried by waterlogged wood dated from the middle Neolithic period [6]. This source of information is practically indefinite and unfamiliar to the Greek archaeological background up to date [2].

A vast assemblage of exceptional and significant archaeological evidence was revealed including several constructional elements like posts and wooden hut floors. Several of these elements were identified as pine (*Pinus* sp.) providing unique information on past environment of the area. Studies of archaeological wood are considered a separate specialist area and an important resource that can provide fundamental information about past human culture and development. The primary value of archaeological wood lies in its significance to convey information about people through time. The widespread use and workability of wood in human societies, has resulted in high data content [5]. Information on forest species and the local arboreal vegetation around a site can be attained through taxonomic identification. This may prove useful in highlighting differences between the range of taxa growing near the site and those actually used [1]. Identification of wood might help address questions about how past populations assessed and exploited different habitats, providing socioeconomic and ethnobiological information [8].

The three archaeological pine posts presented in this work were sampled for studies on their preservation state. Assessing wood biodeterioration provides a unique opportunity to examine wood specimens which have survived due to select properties of the wood itself and / or the depositional environment, characterizing the site parameters of the zone from which the wood was removed and correlating them to the specific types and causes of degradation [4]. Density measurements were used to reflect the susceptibility of the archaeological wood samples to collapse, as well as for monitoring the state of preservation. The examination of the ultrastructure using scanning electron microscopy identified structural patterns of degradation in the internal of the samples.

## 2. Materials and methods

### 2.1 Wood identification

The samples of the archaeological wood samples from Cheimaditis Lake were sectioned using double sized razor blades to produce transverse, radial longitudinal and tangential longitudinal sections. These were examined using a reflection light microscope Nikon SM2-2T with objective

lenses at a magnification range of  $\times 1 - 100$  as well as under high magnification using a Nikon Labophot 2 HFX-DX transmitted light microscope at a magnification range of  $\times 40 - 400$ . It was observed that samples previously dehydrated with methanol provided much better sections. The method was applied to both samples prior to identification, to facilitate identification and provide better results.

### 2.2 Density and maximum moisture content %

The density of the cell wall material is defined as the mass of the cell wall material divided by its volume [3], [7]. The waterlogged volume was determined by measuring the buoyancy force while submerging the object in water, according to Archimedes principle [3]. The samples were then oven dried at  $105\text{ }^{\circ}\text{C}$  for 24 hours and allowed to cool in a desiccator to avoid absorbing moisture. The oven dry mass was weighed after the samples cooled. The density of cell wall material was calculated according to the equation (1):

$$D = \text{Mass}_{\text{Oven dry}} / \text{Volume} [\text{gr}/\text{cm}^3] \quad (1)$$

### 2.3 Ultrastructure determination

The archaeological wood samples were observed visually by scanning electron microscopy (SEM) in order to determine their ultrastructure.

Cross sections of transverse, radial longitudinal and tangential longitudinal were cut from each sample, using double sided razor blade or scalpel, and with tweezers they were placed on two-sided carbon disks already placed on aluminum SEM stubs. Sections were analysed from both internal and external structure of each sample.

For both wood samples, any preparation was not considered necessary, given that they were waterlogged and were examined under low vacuum.

The samples were examined using a FEI Quanta 400 scanning electron microscope. Micrographs were taken using 20 kV. Spot size varied according ultimate resolution required. The smaller the spot size of the primary beam, the better will be the image resolution.

## 3. Results

### 3.1 Identification

The classification of pine was based on the presence of numerous axial resin canals (Figures 1, 3, and 5). The transition from earlywood to latewood was rather abrupt to abrupt with the latewood pronounced. The study of the tangential longitudinal section of pine included the width and height of the rays, which were found to be uniseriate in all samples studied, with a height varying from 5-9 to 3-15 cells height (Figures 2 and 4). In the radial longitudinal sections, cross-field pinoid or fenestrate pits were observed. The identification for the *Pinus* sp. wood could not be taken further than the genus level, however resulted in one of the following species: Scots pine (*Pinus sylvestris*), Austrian pine (*Pinus nigra*), Macedonian pine (*Pinus peuce*), Bosnian pine (*Pinus leucodermis*) and Stone pine (*Pinus pinea*).

### 3.2 Density and maximum moisture content %

All three archaeological samples of pine from were found to have decreased density, demonstrating a moderate degree of degradation as well as deterioration and depletion of carbohydrates, lignin, extractives etc. The possibility of the material collapsing is highlighted, especially during recovery, storage or conservation if precautions are not followed to prevent drying.

Table 1. Density of archaeological samples was found reduced, demonstrating a moderate degree of degradation.

Samples	Sample 1	Sample 2	Sample 3	Ref. material
Density ( $\text{g}/\text{cm}^3$ )	0,25	0,13	0,146	0,483
Mass lost %	48	73	70	---

### 3.3 Ultrastructure determination

A distinctive desegregation of early-latewood and the more advanced distortion of the latewood cell walls was identified in all samples (Figures 10 and 13). The biodeterioration seemed fairly uniform and in a quite advanced stage. To some extent, the degree of the decomposition varied within each sample. Minor differences appeared in the deterioration of the resin canals which were either less degraded or had completely disappeared leaving behind microscopic fissures.

The fibres appeared delignified, while intact tracheids were hardly identified (Figures 7 to 11). Furthermore, the fibres appear to have lost their strength and structure due to the degradation of hemicelluloses. The middle lamellae (ML) remained.

The S<sub>1</sub> and S<sub>2</sub> layers were either highly degraded or completely degraded and had disappeared, highlighting a preferential degradation of the S<sub>2</sub> layer. Locally, the S<sub>3</sub> layer was identified and could be characterized as less degraded but still rather porous and fibrillar. Collapsing areas were identified locally. The dome of the pits appeared degraded and had lost shape (Figure 12 and 15).

### 4. Conclusion / discussion

There has certainly been a lack of research on lignocellulosic material in the dry-land archaeology in Greece. The study of archaeological wood from Greece is an important resource that can provide fundamental information about past human culture and development. For the first time, pine species has been identified in the construction of Neolithic settlements in Greece.

The identification of pine in this archaeological assemblage provides valuable information about Neolithic human culture in the area. The preservation and identification of *Pinus* species has led to some speculations regarding the choice and use of wood resources. The use of pine for constructional purposes during the Neolithic might indicate that those communities acknowledged the properties of the material (resistance to decay and strength) and accessed it from more distant areas.

Wood density was reduced to 63% (average) of the original value, so the mechanical properties are expected to be reduced accordingly. It is clear that a considerable wealth of information would be lost by active deterioration brought about by fluctuating environmental conditions during storage and disposal. However the anatomical elements of the samples are well preserved.

The study of ultrastructure confirmed the extent of deterioration. SEM micrographs demonstrate the preservation of the middle lamellae and primary walls, explaining the preservation of the structure.

The observed degradation features in the archaeological samples could be attributed to bacteria and possibly fungi; however there were difficulties in clearly identifying the forms of decay.

### Acknowledgments

This project was funded through a scholarship from the State Scholarships Foundation of Greece (IKY). We also thank Dr. P.K. Kavvouras, Mr. Panayiotis Chrysostomou and Mr. Stuart Fox.

### References

- [1]. Brunning, R. (1995): Waterlogged wood: guidelines on the recording, sampling, conservation and curation of waterlogged wood. London: English Heritage.
- [2]. Chrysostomou, P. (2007): Personal communication.
- [3]. Jensen, P. and Gregory, D. (2006): Selected physical parameters to characterize the state of preservation of waterlogged archaeological wood: a practical guide for their determination. *Journal of Archaeological Science* 33(4): 551-559.
- [4]. Jordan, B.A. (2001): Site characteristics impacting the survival of historic waterlogged wood: A review. *International Biodeterioration and Biodegradation* 47: 47-54.
- [5]. Peterson, C. E. (1990): New directions in the conservation of archaeological wood. In: R. M. Rowell & J. Barbour, R. (eds) "Archaeological wood: properties, chemistry and preservation". *Advances in Chemistry Series* 225: 433-449. Washington D.C. American Chemical Society.

- [6]. Petrou, M.D. (2008): Development of methodology for the in situ preservation of wetland archaeological sites in Greece. PhD thesis, Division of Archaeological, Geographical and Environmental Sciences, University of Bradford, Bradford.
- [7]. Schniewind, A. P. (1990): Physical and mechanical properties of archaeological wood. In: Rowell, R. M. and Barbour, J. (eds) "Archaeological wood: properties, chemistry and preservation". Advances in Chemistry Series 225: 87-109. Washington D.C.: American Chemical Society.
- [8]. Schweingrüber, F. H. (1996): "Tree rings and environmental dendroecology". Berne, Stuttgart, Vienna, Haupt: Birmensdorf, Swiss Federal Institute for Forest, Snow and Landscape Research.

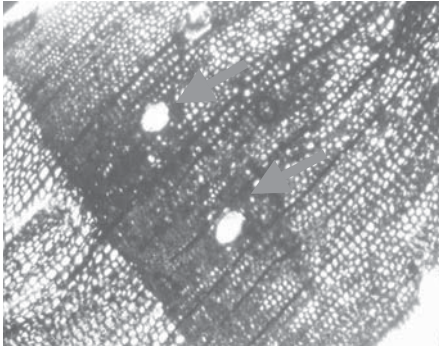

Fig. 1. Transverse section of archaeological pine wood sample 1. Resin ducts in the latewood (arrows). Abrupt transition from earlywood to latewood latewood pronounced (magnification x200).

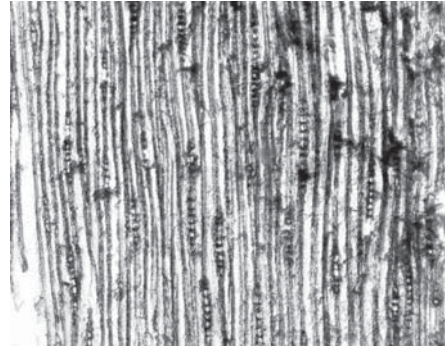

Fig. 2. Tangential section of archaeological pine wood sample 1. Rays are uniseriate, with 3-15 cells (magnification x40).

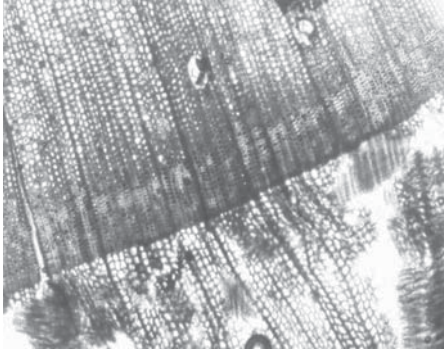

Fig. 3. Archaeological pine wood sample 2. Resin ducts in the latewood. Abrupt transition from earlywood to latewood and latewood pronounced (magnification x200).

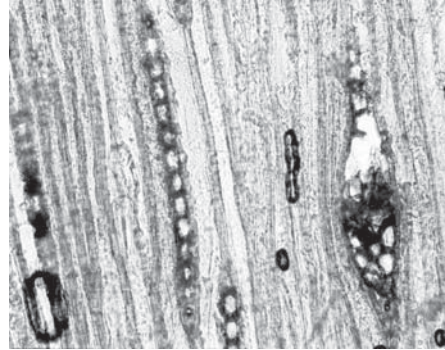

Fig. 4. Tangential section of archaeological pine wood sample 2. Rays are uniseriate. Characteristic fusiform ray surrounding a resin canal complex (magnification x200).

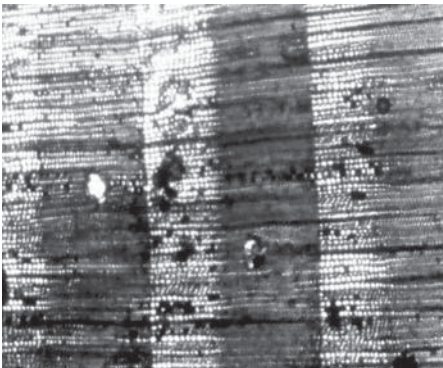

Fig. 5. Archaeological pine wood sample 3. Resin ducts in the latewood. Transition from earlywood to latewood is abrupt and the latewood pronounced (magnification x20).

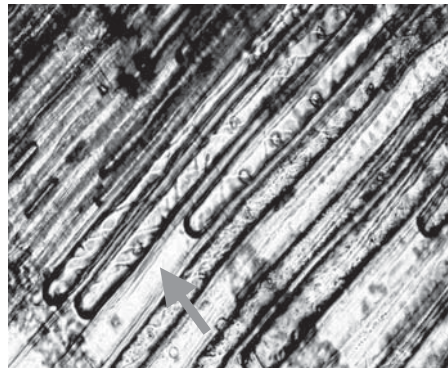

Fig. 6. Radial longitudinal section of archaeological pine wood sample 3. Arrow indicates the characteristic spiral thickenings in tracheids (magnification x200).

**Sample 1**

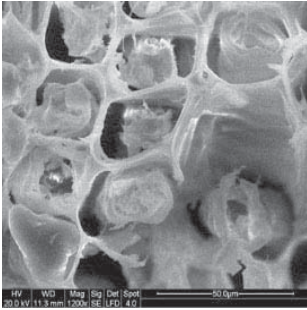

Fig. 7. Latewood cells collapsed. Secondary wall present as a residual structure separated from the ML. The  $S_1$  and  $S_2$  layers seem highly degraded. The  $S_3$  layer is porous and fibrillar

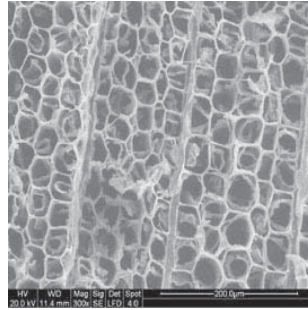

Fig. 8. The earlywood cell walls appear more distorted. The secondary wall is present as a residual structure and separated from the ML. The  $S_1$  and  $S_2$  layers seem highly degraded.

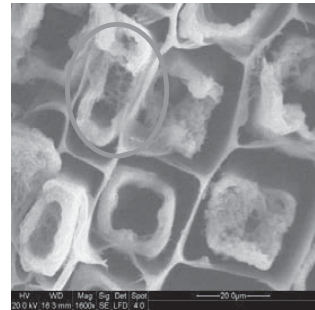

Fig. 9. The secondary walls are extensively degraded. They appear porous and fibrillar. Circle indicates possible fungal hyphae forms.

**Sample 2**

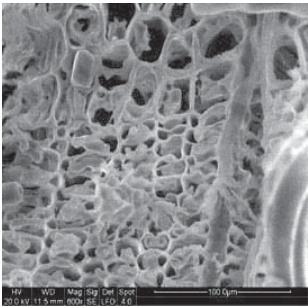

Fig. 10. Latewood appears distorted. Secondary wall present as a residual structure and separated from the ML.

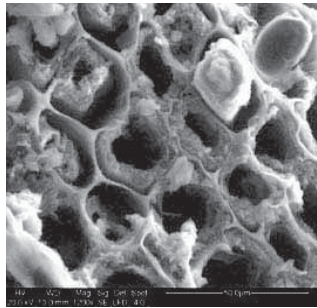

Fig. 11. Secondary wall present as a residual structure and separated from the ML. The  $S_1$  and  $S_2$  layers highly degraded.

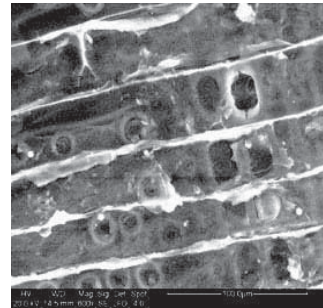

Fig. 12. The dome of the pits seems degraded. Their opening has sometimes been widened.

**Sample 3**

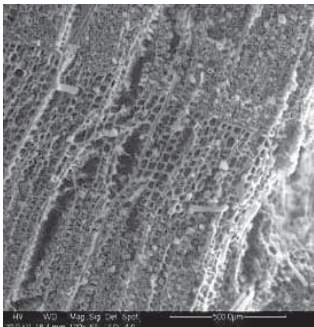

Fig. 13. Distinctive desegregation of early-latewood and the more advanced distortion of the earlywood cell walls.

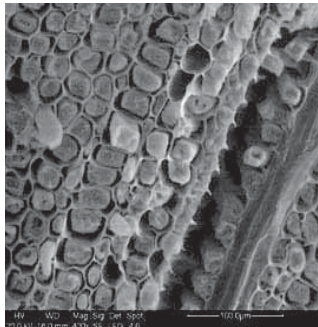

Fig. 14. The latewood appears more robust. Secondary wall as a residual structure and separated from the ML.

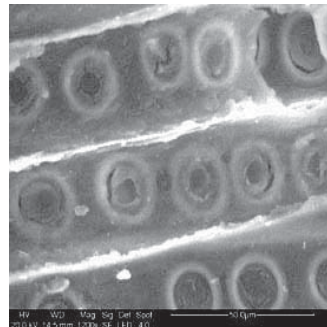

Fig. 15. The dome of the pits seems degraded with widened openings.

# SYNCHROTRON RADIATION MICRO-TOMOGRAPHY: A NON-INVASIVE TOOL FOR THE CHARACTERIZATION OF ARCHAEOLOGICAL WOOD

Diego Dreossi<sup>2</sup>, Stefano Favretto<sup>3</sup>, Marco Fioravanti<sup>1</sup>, Lucia Mancini<sup>2</sup>, Luigi Rigon<sup>4</sup>, Nicola Sodini<sup>1-2</sup>,  
Giuliana Tromba<sup>2</sup>, Franco Zanini<sup>2</sup>

<sup>1</sup> DEISTAF, University of Florence

<sup>2</sup> Sincrotrone Trieste - Area Science Park, Basovizza, Trieste, Italy

<sup>3</sup> Dipartimento Materiali e Risorse Naturali, University of Trieste, Italy

<sup>4</sup> ICTP, Strada costiera 11, Trieste, Italy

franco.zanini@elettra.trieste.it

## Abstract

Archaeological wood, and waterlogged archaeological wood in particular, are almost always characterised by a modification in the original properties and structure of the wood. Degradation agents can be of different origins (Biological, Chemical, Physical) and they are able to produce a large variability in the degradation of individual pieces, requiring their characterization for a proper conservation. X-ray computed Micro-Tomography (X-ray  $\mu$ CT) is a powerful tool, which provides three-dimensional information on the morphological characteristics of materials. Contrary to other analysis, it gives a full insight of the inner structure of the material, in a totally non-destructive way and without requiring a specific sample preparation. In this study the measurements were performed on archaeological and recent wood samples; its main aims were:

- to obtain two- and three- dimensional characterization of archaeological wood in order to evaluate if X-ray  $\mu$ CT can be a powerful tool for the investigation of anatomical features of wood;
- to obtain a quantitative description of the level of degradation by measuring the linear attenuation coefficient and material density.

The experiments were carried out at the SYRMEP beam line of the Elettra synchrotron light source at Trieste (Italy) and at TomoLab, a new X ray micro-focus generator located at the same Elettra site.

## 1. Introduction

Archaeological Wood is wood that has been excavated from different types of archaeological sites, including marine and submerged environments. In these last cases the time during which wood has been waterlogged is considerably long, often over one thousand years. The characteristics of these finds might be rather different from those of recent wood, as a result of the activity of different deterioration agents (biological, chemical, physical, mechanical, etc.). Furthermore the different conservation sites (type of water, soil composition, etc.) represent a further element of complexity that may affect wood degradation. In this context very important are methods and techniques that can be applied for the characterization of this particular type of wood.

X-ray computed Micro-Tomography (X-ray  $\mu$ CT) is a powerful tool that provides three-dimensional information on the morphological characteristics of materials, giving a full insight of their inner structure in a non-destructive way, without requiring a specific sample preparation.

Furthermore, by means of suitable algorithms, starting from a set of planar images (projections) it is possible to reconstruct a volumetric map of X-ray linear attenuation coefficient.

In this study the X-ray  $\mu$ CT has been applied to the characterization of archaeological wood with the specific aims of evaluating its potentiality as a tool for 1) the investigation of anatomical structure of wood (i.e. determination of wooden specie), and 2) the assessment of wood degradation through the measurement of residual density. The experiments were carried out at the SYRMEP beamline of the Elettra synchrotron light source at Trieste (Italy) and at TomoLab, a new X ray micro-focus generator located at the same Elettra site.

## 2. Material and methods

### 2.1 X-ray micro-tomography with synchrotron radiation light

The main characteristics of synchrotron radiation are the continuous spectrum, extending from infrared to hard X-rays, the high spatial coherence, and the intensity of photons emitted in a small solid angle. This makes it possible to work with short exposure times, allows for tuning the photon energy as a function of the sample characteristics, and, in some cases, makes it possible to apply

digital subtraction techniques. Phase-sensitive imaging techniques, using highly coherent, hard X-rays from 3rd-generation synchrotron sources, have the additional advantage of allowing the imaging of samples with very low absorption contrast, such as light-element composites, and biological systems [Snigirev and others 1995] [Cloetens and others 1996]. The X-MCT investigations were carried out using the SYRMEP beamline [Arfelli and others 1995] of the Elettra Laboratory in Trieste, Italy.

The samples, mounted on a rotation stage, were illuminated by monochromatic radiation ( $E = 15$  KeV). The distance between the sample and the detector was less than 50mm when the absorbing images were collected, and at 300 mm. for the image in phase contrast regime.

For each tomographic set 900 projections of the sample were acquired for equally spaced rotation angles and measurement times of 1 s, over a total rotation of 180 degrees.

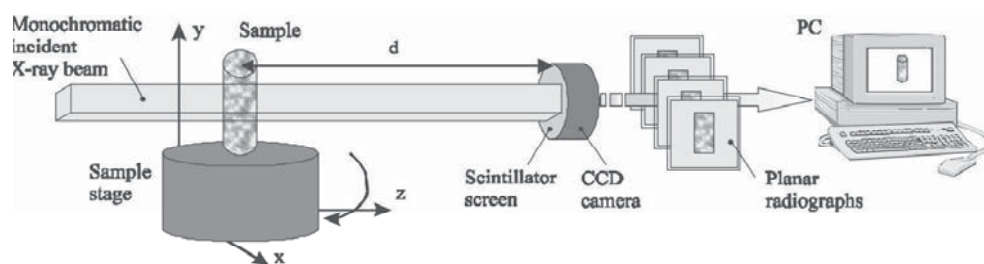

Fig. 1. Schematic view of the experimental setup used for the X-MCT at SYRMEP beamline of ELETTRA.

The detector used was a cooled charge-coupled device (CCD) camera coupled to a Gadolinium Oxysulphide scintillator (Photonic Science Ltd, Boulder, Colo., U.S.A.) placed on a straight fibre optic coupler. High dynamic range and low noise is achieved through 16-bit digitization and deep cooling, whereas the  $4008 \times 2672$  pixels CCD is characterized by a pixel size of  $9 \mu\text{m}$ .

The tomographic projections have been processed using a set of routines [Montanari 2003]. These routines allow the reconstruction of single slices; data can then be saved in several formats and subsequently loaded by other applications for visualization and analysis. The computer code is written in the interactive data language (IDL).

The 2D reconstruction is performed using a filtered back projection algorithm [Herman 1980], for each projection an intensity map is recorded in the xy detector plane; then each intensity map is back-projected along the normal to the projection itself. Projections are submitted to filtering procedures to eliminate noise and artefacts and, finally, the intensities are added for all the projections.

Then, the reconstructed slices can be visualized as stacks of 2D images, or 3D views of the sample can be obtained by volume rendering procedures. Rendering process was performed using the ImageJ software (version 1.37, Natl. Inst. of Health, Bethesda, Md., U.S.A. ImageJ software is in the public domain and is available from <http://rsb.info.nih.gov/ij> or <ftp://rsbweb.nih.gov/pub/imagej>) and Volume Graphics VGStudio 1.2.1 (commercial software).

## 2.2. Density determination

One of the critical problems in the application of CT to wood, and to archaeological wood in particular, is that of turning attenuation coefficient values, directly measured by the device, into density values. In fact, if for imaging and for morphological analysis, the knowledge of  $\mu$  coefficient can be considered sufficient, density characterization needs a calibration process.

In order to achieve this aim two different steps are needed: the first consists in determining  $\mu(x, y)$  in each pixel of the image, the second in the transformation of such values in density values.

By using known and homogenous material, a linear function for the normalization of slices, at 15 KeV, was found and then different methods for the determination of wood density were developed and tested.

According to a transformation of Beer-Lambert law the integral of  $\mu$  along a considered path is:



$$\ln \frac{N_0}{N_1} = \int_{path} \mu(x, y) dx \quad [1]$$

where the term  $\mu(x, y)$  represents the values of the linear attenuation coefficient at the point  $(x, y)$ . The relation between  $\mu(x, y)$ ,  $E$ ,  $\rho$  and  $Z$  is:

$$\frac{\mu}{\rho} = k \frac{Z^4}{E^3} \quad [2]$$

where  $k$  is a constant.

If the value of linear attenuation coefficient has to be read directly from the images acquired in absorbing mode, a first calibration of the system is required.

In order to achieve that, samples in which density ( $\rho$ ), atomic number ( $Z$ ) and the linear attenuation coefficient  $\mu(x, y)$  were known for a given X-ray energy were scanned [liquid Propane ( $C_3H_8$ ), Acetone ( $C_3H_6O$ ), distilled water ( $H_2O$ ), Glycerol ( $C_3H_5(OH)_3$ ), Chloroform ( $CHCl_3$ ) and Aluminium (Al)]. The correlation between theoretical and measured values has been verified by fitting the data. A calibration curve of theoretical versus measured values was obtained, and used to directly measure the linear attenuation coefficient in each  $(x, y)$  point of the sample.

For the transformation of the determined value into density values two different method have been tested: the method of CT numbers [Lindgren 1991] and a new method, called method of “*average density*”. In the first method the reference is represented by the density of water, while for the second method the average density  $\rho_w$  of the sample (at the same MC value that the sample will have during the X- $\mu$ CT scanning) needs to be known.

### 2.3 Sample preparation

In relation with the size of the camera’s field of view, samples were cut along the fibre direction with the shape of little parallelepipeds, approximately 30mm by 15mm, with maximum dimension in transversal direction. As the cell wall in waterlogged woods is completely filled of water and its density often heavily reduced by degradation, in saturation condition its residual density is very close to that of water, making very difficult to distinguish between the two phases (wood and water). Because of that, for the measurement of density samples have been dried in a controlled oven at 103 °C for 24 hours, and then enveloped with Parafilm in order to avoid water adsorption and desorption.

## 3. Results

### 3.1 Morphological results

Looking at the comparison between images obtained by optical microscope and the tomographic reconstruction (Fig.2), it is obvious that also on archaeological wood, as well as on recent wood, X-ray  $\mu$ CT allows for an easy detection of most part of the anatomical features useful for wood identification. The three-dimensional (3D) reconstruction of the whole samples (fig.3), made possible because the samples were exposed to the irradiation beam along their longitudinal axis, allows the visualization of morphological and structural aspects within the entire volume of the specimens. After that the virtual image is reconstructed, the sample can be cut in any plane or direction, and all the typical sections (cross, radial and tangential) can be virtually obtained.

### 3.2 Density measurement

In figure 4 is reported the fitting of the relationships between theoretical values of linear attenuation coefficient and the experimental ones, obtained from the scanning of the various substances chosen as reference for different values of density.

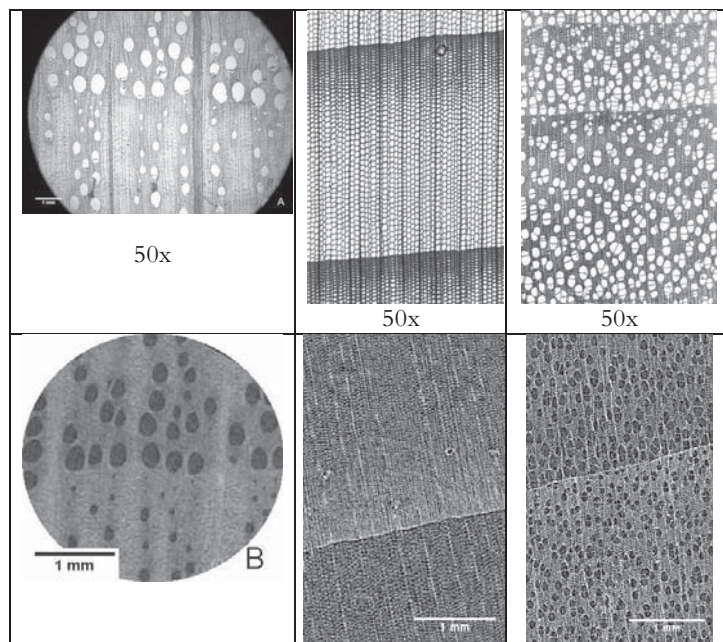

Fig. 2. Comparison between images of cross sections with optical microscope (up) and X-MCT (down). From left to right: oak: early wood porous vessels and parenchyma rays; spruce: early and late wood, presence of resin ducts; poplar: diffuse porous distribution of vessel.

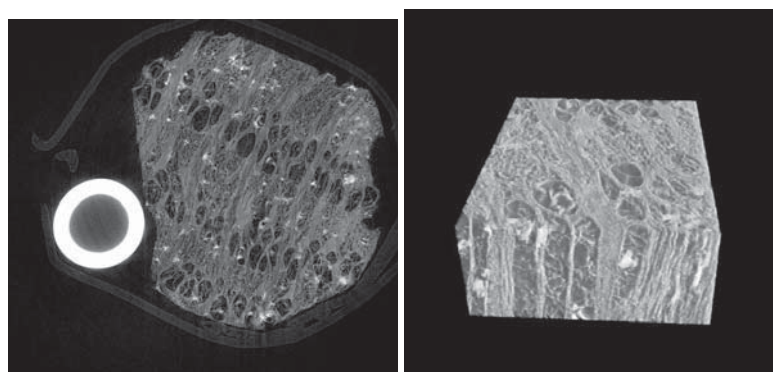

Fig. 3. Left: Cross section of archaeological oak wood (on the left of the wood sample a plastic pipe filled with distilled water); right: the same sample after 3D reconstruction. In both 2D and 3D images are clearly visible, within the structure, mineral concretions (whitish elements) that are largely present in waterlogged archaeological wood.

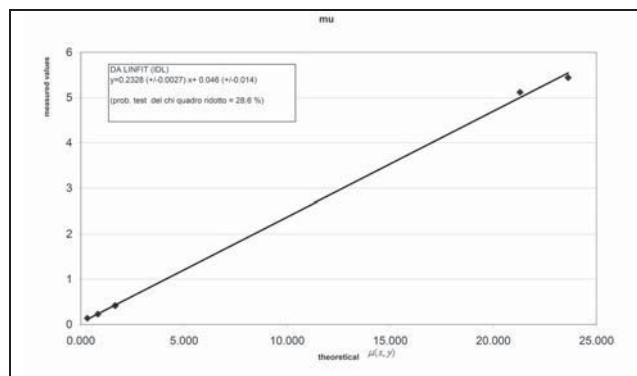

Fig. 4. Theoretical versus measured values linear attenuation coefficient.

The parameters obtained from the model are the following:

$$y = 0.2328(\pm 0.0027)x + 0.046(\pm 0.014) \quad [3]$$

In order to directly measure the values and the punctual variation of linear attenuation coefficient, all the slices reconstructed were normalized applying equation [3].

In each sample  $\mu$  was measured along single line of pixels, and as average values in selected areas, chosen avoiding parts too close to the edges of the sample.

Measurements performed on samples of recent wood belonging to Oak, Spruce, Poplar and Larch have given the average results of  $\mu$  reported in Table 1.

Table 1. Measured values of linear attenuation coefficient on different species.

Sample	Average $\mu$	Density at MC% 12
Oak	1.259 cm <sup>-1</sup>	0.80 g/cm <sup>3</sup>
Larch	0.490 cm <sup>-1</sup>	0.65 g/cm <sup>3</sup>
Poplar	0.445 cm <sup>-1</sup>	0.50 g/cm <sup>3</sup>
Spruce	0.327 cm <sup>-1</sup>	0.42 g/cm <sup>3</sup>

According to equation [2] variations of linear attenuation coefficient are strictly dependent from the chemical composition and the density of the examined material. As in wood chemical composition (that affect the atomic number  $Z$ ), can be considered almost the same in all species, the variation of  $\mu$  is due to the different values of density typical of each species. This has been confirmed by the experimental results obtained, where  $\mu$  increase its value as the density of the relevant wood species increase (Table 1). The higher values of  $\mu$  in Oak can be also explained considering the large amount of extractives present in the heartwood of this species. Even their percentage in chemical composition is little, they have an important influence on the  $Z$  number of the material and considering that  $Z$  is raised to the fourth power in equation [2]. For the same reason the high content in mineral elements (Iron salts mostly) typical of waterlogged wood (see figure 3), may affect quite a lot the value of attenuation coefficient.

Applying the two methods of conversion (i.e. CT number and average density) it has been possible to read the profile of punctual variation of  $\rho$  (variation every each 10 microns) along a pre-selected profile within the scanned samples. An example of comparison between the two methods is reported for a sample of oak wood in figure 5.

The values are in the range typical of the specie, and they show a good agreement between the two methods, especially for the lower values of density (i.e. inside the porous vessels). In the parts of the sample characterised by higher values of density (presence of fibres or smaller cellular elements) the method of average density seems to systematically give higher values.

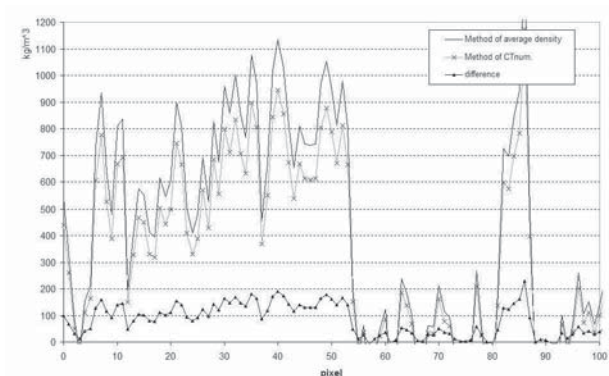

Fig. 5. Density profiles within an annual ring of oak wood. The two curves have been obtained applying the two conversion methods proposed.

#### 4. Conclusion

Results obtained with this preliminary work have shown that X-ray  $\mu$ CT can be a powerful tool for the analysis of waterlogged archaeological wood at least for morphological studies. The two methods proposed for turning values of attenuation coefficient into density seem to be promising, even if a further and deeper experimentation is needed, in order to better understand the differences noticed for the higher values of density within annual rings.

#### References

- Hounsfield, G.N. (1973): Computerized transverse axial tomography. *Br. J. Radiol.* 46: 1016-1022.
- Cormak, A. M. (1963): Representation of function by its line integrals with some radiological application. *J. Appl. Phys.* 34: 2722-2727.
- Lindgren, L. O. (a) (1991): Medical CAT-scanning X-ray absorption coefficients, CT-numbers and their relation to wood density. *Wood Science and Technology* 25:341-349.
- Lindgren, L. O. (b) (1991): The accuracy of medical CAT-scan images for non destructive density measurements in small volume elements with solid wood. *Wood Science and Technology* 25:425-432.
- Herman, G. T. (1980): *Image reconstruction from projections – the fundamentals of computerized tomography.* New York, Academic Press.
- Baruchel J, Buffière JY, Maire E, Merle P, Peix G. (2000): *X-Ray tomography in material science,* Paris Hermes Science Publications.
- Arfelli M, Bravin A, Barbiellini G, Cantatore G, Castelli E, Di Michiel M, Poropat P, Rosei R, Sessa M, Vacchi A, Dalla Palma L, Longo R, Bernstorff S, Savoia A, Tromba G. (1995): Digital mammography with synchrotron radiation. *Rev Sci Instr.* 66:1325-8.
- Snigirev A, Snigireva I, Kohn V, Kuznetsov S, Schelokov I. (1995): On the possibilities of X-ray phase-contrast micro imaging by coherent high-energy synchrotron radiation. *Rev Sci Instr.* 66:5486-92.
- Cloetens P, Barratt R, Baruchel J, Guigay JP, Schlenker M. (1996): Phase objects in synchrotron radiation hard X-ray imaging. *J Phys D Appl Phys* 29:133-46.
- Montanari, F. (2003): SYRMEP TOMO PROJECT, ELETTRA, Trieste.
- Sergejewa A.S. (1959): “Chemie des holze und der Cellulose”, Th. Steinkopffverlag U.B, Leipzig, Dresden.

## “I WAS WALKING IN AN 8 MILLION YEAR OLD FOREST...”

*János Veres*

Directorate of B-A-Z County Museums  
Herman Ottó Museum, Archaeological Department, Miskolc, Hungary  
veresj@hermuz.hu

In July of 2007 a 16-trunk forest section of the upper Miocene era has been uncovered in the bottom of the 60-metre deep Bükkábrány open pit mine (Northeast Hungary). The unearthed fossil forest part of Bükkábrány, due obviously to its unequaled nature, has aroused great publicity and quite a public interest. The unique fossil findings, keeping with the best of traditions of the world, were studied by a multidisciplinary group of acclaimed scientists from a number of local institutes. The 6-metre stumps/trunks of what once have been 40 metres tall bald cypresses (*taxodium*) stood at their original site. A natural disaster evidently created a special airtight layer which preserved this part of the forest preventing the tree trunks from fossilizing so they have remained in their original structure for millions of years. This prompted many scientists the unthinkable possibility to obtain a load of scientific information in their own field. The swamp forest of Bükkábrány has remained at its original location leaving no question stratigraphically and presenting a unique picture of this ecosystem of the upper Miocene.

It is clear from the map that the Bükkábrány mine site of the Mátra Power Plant is based on lignite originating from the upper Miocene. An extensive swamp forest grew along the northern coastline of what once was the Pannon Sea at the bases of today's Mátra Mountain and this shows a fairly perfect concurrence with the lignite field that exists between two regional towns, Gyöngyös and Polgár today. By studying the mine's stratigraphical maps it was clear that the forest we found on the lignite buildup is from between 11.6 and 5.3 million years ago. Since mining is chiefly built on extensive stratigraphical knowledge of our geological history, it can be stated in confidence that there can be no mistake. The devastation of this coastal forest of the Pannon Sea can be dated back to 8 million years ago based on the age of a 3-metre thick lignite layer on which it is found.

This part of the forest in question had been covered in sand 6 metres deep preventing it from falling and fossilizing thus preserving it with a minimal change in its structural morphology for the past 8 million years. How can it be? A sub-science within archeology, called taphonomy, has been studying such processes for quite some time. The name came from I. A. Efremov Russian paleobiologist in 1940 and derives from the Greek words: taphos (grave) and nomos (law). This science, which is commonly called the „science of burial”, studies processes like what happens to an organism after its death and until its discovery as a fossil. This includes decomposition, post-mortem transport, burial, compaction, and other chemical, biologic, or physical activity which affects the remains of the organism. How these remains of the biosphere, living organisms become particals of the litosphere, the world of fossils.

Taphonomy studies post-mortem processes but other circumstances have to be taken into account too like biostratinomy of the place that had been present there well before the burial. The variation in the age of trees, young sapplings, dying old decayed tree trunks, drift wood, tree stumps, ground growth, pollens, wildlife perhaps. In other words all the effects that had happened in the forest in its existance before its burial. Normally the process of fossilization or fossil diagenesis begins immediately after burial and conception of the biosphere into the litosphere. This very process has never occurred in Bükkábrány the absence of which allows us to get a much clearer picture and defying the forces that shaped this region in geological history.

A 6-metre deep layer of wet sand or silt suddenly covered the lower part of the forest sealing in airtight every living organism that once had belonged to this biosphere. In the one hand this wet, airless environment preserved the remains but on the other hand prevented fossil diagenesis from happening. As a result we have a frozen moment of that exact paleoenvironment in front of our eyes. The forest above this preserving layer decayed slowly the evidence of which can be found both in the top layers or in the bottom where driftwood and other stuff have sunk. 8 million years passed in the meantime, the geological processes of which along with the landscape forming ages have covered this ancient coastline with 60 metres of debris. The formation of what is the Hungarian landscape today and the formation of the mining industry began.

We pointed out how different the Bükkábrány findings are from others of the same era most of which are fossil remains. We have to add that even though the fossil diagenesis could not happen in its drastic form, partially and in traces it can be observed even in the Bükkábrány tree trunks. What happened does not qualify as total preservation but instead a process of airtight conservation and another one in a special taphonomical environment in which the post-burial processes that took place in an 8-million year timespan were reduced to minimal. The result occurs in special paleobotanical happenings, (or in the lack of) like how the roots became part of the lignite and how marcasite filled out the cracks of the wood. The original structure of the trees are still studied by various scientific methods as we speak. How much carbon the tree trunks contain, in other words at what level of carbonization they have gone thru is just as exciting a question as where all the cellulose vanished from the wood and just what exactly can we substitute it with. A very low concentration of carbon is expected as carbonization is the process that would turn these trunks to peat or lignite. The presence of marcasite in some of the trees are an example of the middle state of how part of the biosphere turns into part of the lithosphere.

### Study of the forest

I was told we found a bald cypress forest (*Taxodium* by its scientific name). In the field all signs of the species were accounted for. Bald cypresses can grow to a height of 40-45 metres and their sizable (3 metre in diameter) trunks are supported by sprit like root shoulders. In water they grow breathing roots the function of which is still unknown.

Marking the metric characteristics of these trees like trunk diameter, height, distance from each other are quite important. The distance is significant because this shows the size of the canopy thus the amount of light in the forest. The above illustrates a dense, healthy population of 40-metre tall bald cypress forest. Judging from the distances of the stumps the canopy was probably so dense that hardly any light could have found its way down to the forest floor. The core samples taken from the stumps show signs of natural decay which means a few dying trees in the group. Some fallen trees are evident on the forest floor which also indicates a healthy but mixed biotope of young and old cypresses.

We are conducting a study of the annual rings of the stumps with the help of the dendrochronologists of the University of Eötvös Lóránd. The rings show human fingerprint like dense lines. We judge these trees to be 3-400 years old. If we take the various ages of the population as a whole into account the scientists can hope for 1500 years worth of climatic data.

The study of the roots resulted in interesting findings. The so-called breathing roots that grow straight upward from the ground surrounding the host tree, we can only identify by oval shaped markings. But what seems like a failure in the paleobotanical field can help interpreting geological and taphonomical processes. By digging deep enough we lose the structure of the cypresses the roots of which became one and the same with the mineral environment. In the cracks are shiny deposits of marcasite. In „root-depth” there are markings of movement which means that the depositing of the peat had been going on before the complete burial. The cypresses, we can conclude, lived in a swamp in which the bottom was made of thick layers of decomposing plant material and where the last living biotope atop was the taxonium forest.

The stumps are all the same height which is also the height of the grey deposit around the trees. Above this is a yellow sandy layer in which the forest cannot even be traced. It is quite clear that this grey deposit helped preserve the stumps by creating an airtight layer over the millions of years, but the same layer evidently killed the trees also. The 6-metre thick deposit quickly covered the forest and hugged the trees. These trees lived for a long time after that and the normal decomposition of the forest is evident in the deeper layers. We uncovered plenty of branches and tree bark which shows the dying of the canopy whereas the lower parts of the tree trunks were preserved by the silty deposit around them.

The on-site research had finished when 4 of the trunks were relocated to the museum and the original site has been destroyed due to the mining technology. Recently 4 saved trunks are waiting for further scientific and laboratory-research.

## References

- Efremov, I.A. (1940): Taphonomy: a new branch of paleontology. *Pan-American Geologist* 74, 81-93.
- Renfrew, C., Bahn, P. (1999): *Régészet. Elmélet, módszer, gyakorlat.* Budapest. (Osiris kiadó)
- Gilman, E.F., Watson, D.G. (1994): *Taxodium distichum-baldcypress.* Department of Agriculture, Forest Service, Southern Group of State Foresters, Facht Sheet ST-620, 4 p.
- Kordos, L., Begun, D.R. (2002): Rudabánya: a Late Miocene subtropical swamp deposit with evidence of the origin of the African apes and humans. *Evolutionary Anthropology*, 11, 45-57.
- Magyar, I., Geary, D., Müller, P. (1999): Paleogeographic evolution of the Late Miocene Lake Pannon in Central Europe, *Palaeogeography, Palaeoclimatology, Palaeoecology*, 147, 151-167.

# EXAMINATION OF DAMAGED WOOD BY AMMONIUM PHOSPHATE AND SULPHATE-BASED FIRE RETARDANTS – THE RESULTS OF THE PRAGUE CASTLE ROOF TIMBER EXAMINATION

*Irena Kučerová<sup>1</sup>, Martina Ohlidalová<sup>1</sup>, Miroslava Novotná<sup>2</sup> and Alena Michalcová<sup>3</sup>*

<sup>1</sup> Department of Chemical Technology of Monument Conservation, Institute of Chemical Technology Prague, Czech Republic

<sup>2</sup> Central Laboratory, Institute of Chemical Technology Prague, Czech Republic

<sup>3</sup> Department of Metals and Corrosion Engineering, Institute of Chemical Technology Prague, Czech Republic  
irena.kucerova@vscht.cz

## Abstract

The original roof timber of many important historical buildings in the Czech Republic is seriously deteriorated by ammonium phosphate and sulphate-based fire-retardant coatings. Mechanism of the corrosion process is not until now known. The contribution brings results of the fuzzy timber research, which show that cellulose and lignin are corroded. It is not possible to identify the reactions that cause their corrosion yet.

## 1. Introduction

The original roof timber of many important historical buildings in the Czech Republic is seriously corroded by ammonium phosphate and sulphate-based fire-retardant coatings. In some buildings, application of such a coating was practised repeatedly within the span of a few years, which brought about accumulation of large quantities of the salts in the timber. [1-4]

The effect of the corrosion is a “fuzzy” wood surface (see Fig. 1). This corrosion can finally cause serious mechanical properties degradation of the plywood and the timber. There are known cases of failures of some timber roofs in the Sydney area, Australia, which were corroded by sea salt [5]. Influence of the fire retardant on mechanical properties of plywood and of wood was investigated by Susan L. LeVan and Jerrold E. Winandy [6-11], but cause of the wood deterioration was not studied.

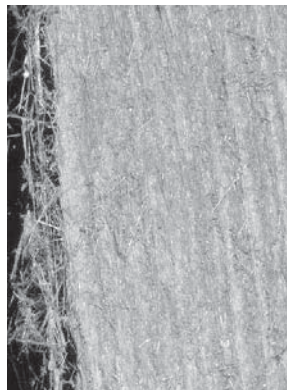

Fig. 1. Fine fibers on wood surface have appeared again after conservation treatment – timber in the All Saints Church attic.

Currently, wood degradation by loosening of the fibrous structure is mostly regarded as an aesthetic deficiency of the historical roof timber. It is associated with a loss of information conveyed by the timber surface, such as traces of working with tools. The problem of degraded wood structure of the roof timber is being addressed so that the degraded wood is removed mechanically to leave the “healthy” wood in place and subsequently, a neutralization solution is applied to the timber.



However, this remedy was found to be efficient for a limited period of time: in a few years after application, the wood degradation process sets in again. In addition, the technology of fire-retardant coating removal is unsuitable as a method of treatment of historical heritage, and a continual thinning of the structural elements is an undesirable side effect as well. [1-4]

## 2. Current state of the attics

Attics of the Old Royal Palace were treated many times by fire-retardants based on ammonium phosphate and ammonium sulphate. As a result of the treatment, damage appeared on the wooden surface – fiberezed appearance. In the period 1997-2001 the attics were investigated and treated [2-4]. The pH value of the wood was measured. The values varied from 4 to 5 depend on the location. The damaged wooden surface was cleaned by brushing and then was neutralized by solutions containing  $\text{CaCO}_3$  and boric acid. Composition of the solution was chosen depending on wood acidity. The pH values increased to 5-6 after neutralization. Then some places were treated by preservatives based on boric acid. Wood corrosion appears again after few years from the neutralization treatment.

## 3. Results of the roof timber examination

Wooden samples from the attics of the Old Royal Palace were taken and studied by pH value measurement, by electron microscopy and by infrared spectroscopy. Measurements of climatic conditions in the attics have been carried out since May 2007.

Ammonium phosphate and sulphate-based coatings cause wood corrosion, presumably through one or more of the following processes or their combination: acid hydrolysis; decrystallization of cellulose; thermal degradation of wood. Acid hydrolysis affects mainly hemicelluloses and cellulose and brings about reduction in their molecular weight. Decrystallization of cellulose is caused by solvents and impregnations inducing wood swelling and causes reduction in the degree of cellulose crystallinity. Thermal degradation is associated with elimination of water from the hemicellulose and cellulose macromolecules, bringing about weakening of the bonds between the wood fibres. The degree of wood damage by thermal degradation depends on temperature, duration of the action and wood moisture. Higher wood moisture accelerates the thermal degradation process because hydrolysis takes place in parallel.

Various literary sources present that the corroded wood exhibits changes of moisture content and acidity. The table 1 illustrates the results of wooden samples pH values as opposed to saturated solutions pH values of ammonium phosphate and ammonium sulphate and old standard wood which was not treated. Determination of pH values were done in extracts prepared from the wood. The results show that pH values of corroded samples significantly differ from the standard wood. Values are approximately about 2 units lower, which indicates that acid hydrolysis could take place. Only the sample from the attic above Vladislav Hall shows high pH value 9.2. In this case alkali hydrolysis could take place. Wood has lower resistance to alkali hydrolysis than acid hydrolysis. The reason is that lignin is easily hydrolysed by alkalis.

Results of the electron microscopy observation show that on the anatomical structure level some cells of the wood exhibited breakdown of the central lamella (cells separation), which is predominantly formed by lignin, while other cells exhibited breakdown of the cell walls, primarily composed of cellulose (cracks in the cell walls) – see fig. 2 and 3. Observation of the fibers, which originate from the wood surface corrosion, indicates that the cell walls have disintegrated into the fibrous tangle (picture 4 and 5). Microscopical research says that both of the main polymers are corroded – in some cases both of them and in other cases either cellulose or lignin only. However, mechanical damage of the wood can not be excluded as well, as a consequence of inorganic salts crystalline pressure.

Table 1. Examples of the pH values wooden sample from the Prague Castle attics

<b>Standard wood</b> – no treated, approx. 150 year old roof timber	
Old Pine	pH 4.4
Old Fir	pH 5.0
Old Spruce	pH 4.4
<b>Fire Retardants</b>	
(NH <sub>4</sub> ) <sub>2</sub> SO <sub>4</sub> : 18.85g/25g water	pH 5.6
(NH <sub>4</sub> ) <sub>2</sub> HPO <sub>4</sub> : 14.375g/25g water	pH 8.3
<b>Samples from the Prague Castle – the Old Royal Palace</b>	
Attic above the House	pH 3.2
Attic above the All Saint Church	pH 4.2
Attic above the Vladislav hall	pH 9.2

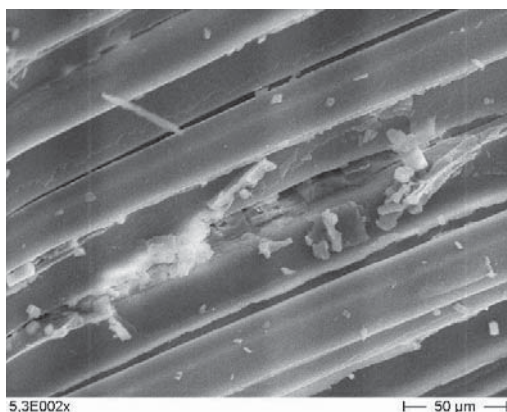

Fig. 2. A Splinter taken from the Vladislav Hall attic.

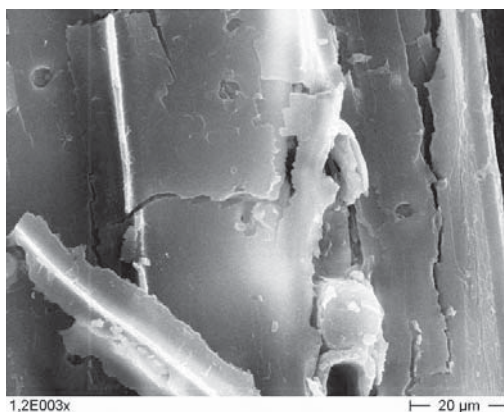

Fig. 3. A splinter taken from the House attic.

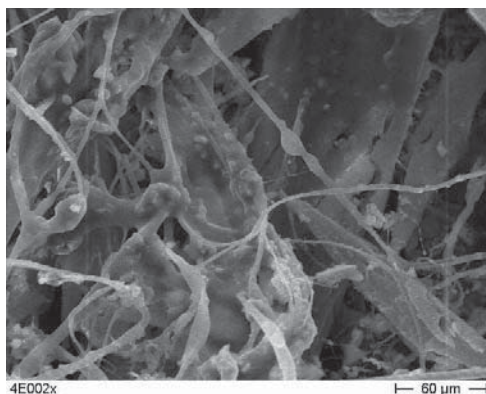

Fig. 4. A fibers sample taken from the All Saints Church attic.

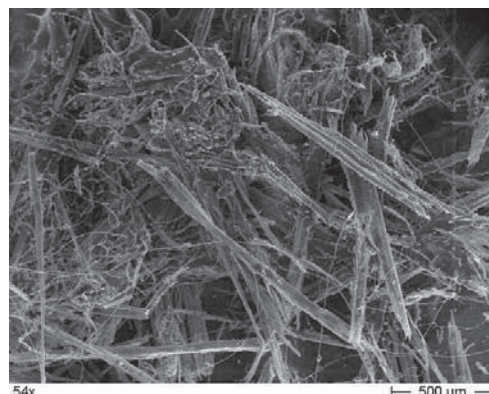

Fig. 5. A fibers sample taken from the All Saints Church attic.

Analysis of the wood samples was performed with FTIR spectrometer Bruker ISF 66v/S (Bruker, BDR) connected to a microscope Hyperion connected with Cassergrain lens for measuring transmittance spectra, detector MCT, beam splitter KBr. Measured parameters were: spectral range 4000–650 cm<sup>-1</sup>, resolution 4 cm<sup>-1</sup>, number of spectra accumulations 1028, apodisation Happ-

Ganzel. The measured spectra were processed by a program Omnic 6.1 (Omnic Instruments Co., USA). Evaluation of changes in the chemical structure was performed after bands isolation in the absorption area 1200–1600  $\text{cm}^{-1}$  and after relative comparison with areas of selected absorption bands of cellulose and lignin, which were calculated according to Gauss and Lorentz function. Table 2 gives information about the selected bands, which were used for the study of changes in the chemical structure of wood. The relative changes in cellulose and lignin content are presented in Table 3.

Table 2. Assigning vibrations to selected bands.

Band intensity [ $\text{cm}^{-1}$ ]	Vibration assigning
1315	wagging vibration of $\text{CH}_2$ bonds in cellulose
1372	Out-of plane deformation vibration of CH bonds in glucosidic ring
1428	bending vibration of $\text{CH}_2$ bonds in cellulose
1463	Asymmetric bending vibration of $\text{CH}_3$ bonds in lignin
1510	$\text{C}=\text{C}$ bonding vibration of lignin aromatic ring

Table 3. Examples of relative changes in wood composition determined by FTIR.

Proportion of intensity bands areas [ $\text{cm}^{-1}$ ] / Sample	1428/1510 (Cellulose / lignin aromatic ring)	1428/1463	1372/1510 (Glucosidic ring / lignin aromatic ring)
Fir - standard	1,227	2,227	1,220
The House – no. 4	2,949	4,970	1,695
The Vladislav Hall no. 9	3,770	3,302	7,986
The Vladislav Hall no. 12	8,961	4,501	4,669

The results given there show there is a decrease of the lignin content in the samples which were taken from the wood surface (fibrous samples). Shifting of band position of  $\text{CH}_2$  group bending vibration in cellulose to a higher wave number (from 1424 to 1430  $\text{cm}^{-1}$ ), is likely to indicate a relative increase of cellulose crystalline part as a consequence of a decrease of amount cellulose amorphous part. Creation of new bands was observed in the spectrum of sample no. 9 from the Vladislav Hall. The phenomenon may be related to oxidation of hydroxyl groups to carboxyl groups which are presented in the sample as a salt form.

The highest temperature approx. 47 °C was measured in the upper part of the attic that was close to southern tiles. In this part of the attic the temperature arose to 40 °C 9 times in summer 2007. Maximal temperature was lower in the bottom part of the attics. This indicates that the temperature is not one of the main polymer corrosion agents.

#### 4. Conclusions

The results presented here show that there occurs a damage of cellulose and lignin but so far it is not possible to identify the reactions that cause their corrosion. Anyway, the initial results gained in our research will be completed in further attic examinations and measurements.

#### Acknowledgement

This contribution was made thanks to the support of Czech Science Foundation (project no. 103/07/1091).

## References

1. Kotlíková O. (2005): Zápis z pracovního jednání rozvlákňování dřeva v památkových objektech. (Minutes from working discussion about wood defibering in culture heritage buildings) Společnost pro technologie ochrany památek (Society for protection technologies of cultural heritage), Praha – Nostický palác červen 2005.
2. Protokol o zkoušce (Test record) 19/01, Výzkumný a vývojový ústav dřevařský, Praha – Výrobní a zkušební laboratoř Březnice (Timber Institute, Březnice, Czech Republic), 2001. – source Technický archiv Správy Pražského hradu (Technical Archive of Prague Castle Administration).
3. Technická zpráva č. 138/24/4/98 (Technical report no.), Výzkumný a vývojový ústav dřevařský, Praha – Výrobní a zkušební laboratoř Březnice (Timber Institute, Březnice, Czech Republic), 1998 – source Technický archiv Správy Pražského hradu (Technical Archive of Prague Castle Administration).
4. Technická zpráva: Protipožární ochrana dřevěných konstrukcí krovů a střeš Pražského hradu (Technical report: Antifire protection of roof timber construction of Prague Castle), Výzkumný a vývojový ústav dřevařský, Praha – Výrobní a zkušební laboratoř Březnice (Timber Institute, Březnice, Czech Republic), 1997 – source Technický archiv Správy Pražského hradu (Technical Archive of Prague Castle Administration).
5. Wilkins A.P., Simpson J.A. (1988): Defibering of roof timbers. *Journal of Institute of Wood Science*, 11(3): 121-125.
6. LeVan, S.L., Winandy, J.E. (1990): Effects of fire retardant treatments on wood strength: a review, *Wood and Fiber Science*, 22(1): 113-131.
7. Winandy, J.E. (1995): Effects of fire retardant treatments after 18 months of exposure at 150°F (66°C), Res. Note FPL-RN-0264, Madison, WI: US Dept. of Agriculture, Forest service, Forest Products Laboratory.
8. Winandy, J.E. (1997): Effects of fire retardant retention, borate buffers, and redrying temperature after treatment on thermal-induced degradation, *Forest Products Journal*, 47(6):79-86.
9. Winandy, J.E., Lebow, P.K., Nelson, W. (1998): Predicting bending strength of fire-retardant-treated plywood from screw-withdrawal tests, Res. Note FPL-RP-568, Madison, WI: US Dept. of Agriculture, Forest service, Forest Products Laborator.
10. Lebow S.T., Winandy J.E. (1999): Effect of fire-retardant treatment on plywood pH and the relationship of pH to strenght properties. *Wood schience and Technology* 33: 285-298.
11. Winandy J.E. (2001): Thermal degradation of fire-retardant-treated wood:predicting residual service life. *Forest Product Journal* 51(2): 47-54.

# STATE OF PRESERVATION OF HISTORIC WOOD FROM FORTIFIED SETTLEMENT OF THE LUSATIAN CULTURE IN BISKUPIN (POLAND)

Magdalena Zborowska<sup>1</sup>, Leszek Babiński<sup>2</sup>, Bogusława Waliszewska<sup>1</sup>, Włodzimierz Prądzyński<sup>1</sup>

<sup>1</sup> A. Cieszkowski Agricultural University in Poznań  
Faculty of Wood Technology, Institute of Chemical Wood Technology,  
Poznań, Poland

<sup>2</sup> Archaeological Museum in Biskupin  
Conservation Department, Biskupin, Poland  
mzbor@au.poznan.pl

## Abstract

Investigations were carried out on the archaeological site in Biskupin (Poland). The assessment of the condition of wood preservation was done by testing chosen physical properties, mass loss and content of its main chemical components. Research aiming at closer acquaintance with the conditions in which Biskupin wood lies included monitoring of the ground water level and the level of water in excavations and in Lake Biskupin, as well as monitoring of precipitation, measurements of pH and specific conductivity of water and measurements of temperature and redox potential of soil.

## 1. Introduction

The defense settlement from the period of Lusatian culture situated in Biskupin belongs to the best-known wet archaeological sites in Europe. The settlement was built on a marshy two-hectare island (presently a peninsula on Lake Biskupin) ca. 740 B.C. at the turn of the Bronze Age and Early Iron Age (Ważny 1993). It is estimated that at least a few thousand cubic meters of wood were used to build the stronghold.

Archaeological research which has been conducted since 1934 revealed huge quantities of relics of wooden structures of the settlement. Huge quantities of historic wood from Biskupin have posed a serious conservatory challenge from the very beginnings of the archaeological work on the site. Long-term investigations conducted on the peninsula of Biskupin lake resulted in mechanical damage and biological degradation of historic wood tissue. Despite undertaking numerous conservatory attempts (Piotrowska 1999), the achieved results were far from satisfactory. The best solution turned out, in accordance with world trends, to leave the wooden relicts under layer of soil.

In mid 2003, the research project was developed to evaluate the burial conditions of the remains of the settlement's wooden structures, to examine the present state of degradation of archeological wood tissue, to identify and classify possible threats, and to develop a complex program for the site's protection.

## 2. The aim of investigations

The aims of investigations carried out in Biskupin settlement frame the following research project:

***assessment of deposition conditions of the wooden relics on the site in Biskupin*** (fig.1)

– *determination of degradation speed of:*

- contemporary oak and pine wood,
- archeological oak and pine wood from other archeological sites,
- cellulose pulp.

All samples were stored in deposition condition of Biskupin archaeological wood. Speed of degradation was determined, based on selected physical properties (maximum water content, conventional density), loss of wood mass, selected chemical properties (percentage of holocellulose, cellulose, lignin, substances soluble in alcohol – benzene mixture, hot water cold water and ash). The following properties were analyzed after 2, 4, 6 and 10 years of storage.

– *measurements of selected parameters of soil and water on the site in Biskupin*):

- groundwater level
- pH and water conductivity
- chemical analysis of water
- soil redox potential

***assessment of degradation degree of the wooden remains on the site in Biskupin***

– *determination of*:

- selected physical properties (maximum water content, conventional density),
- loss of wood mass,
- selected chemical properties (percentage of holocellulose, cellulose, lignin and ash).

### 3. Results Obtained Up To Now

***Concerning contemporary oak and pine wood left on the site (table 1) (Babiński et al. 2006, Zborowska et al. 2007).***

Based on the results obtained after two years of storage we can deduce that weight loss, physical properties, as well as the content of the main chemical components indicate a small extent of degradation of the examined oak and pine wood (tab.1). The recorded changes developed as a result of the enzymatic decomposition of the hemicelluloses as well as the extraction of substance soluble in water. Further investigations on the degradation of contemporary wood tissue in conditions on the deposition of the Biskupin archaeological wood reveal if the initial results signal long-term trends.

***Measurements of selected soil and water parameters (Babiński et al. 2007)***

Measurements made in the years 2003–2006 have shown that, in summer periods, groundwater level decreases to a level equal to the minimum level of lake Biskupin, approaching the preserved wooden construction elements of the settlement (especially in the neighbourhood of station MS1, MS3, and MS6. Fortunately, the layer of peat in which the remains of the settlement are deposited, is able to retain considerable amounts of water, thereby delaying decomposition of the wood. However, vertical elements in the flooded trench and some fragments of wood protruding from the water undergo more rapid decomposition.

In Biskupin, the layer of peat in which one can find deposits of archaeological wood is characterized by highly reducing conditions. Mean redox potential values, measured at the depth of 50 and 100 cm, ranged between -240 and -170 mV (fig. 2). Such conditions are not conducive to fast decomposition of wood tissue. This was confirmed by the research done on samples of recent oak and pine-wood (Babiński et al. 2006, Zborowska et al. 2007). However, in the monitored environment periodic increases in Eh, reaching a value of -50 mV, have been observed. These fluctuations are mainly connected with supplying the site with polluted water from the lake (communal wastes, fertilizers, and pesticides), with precipitation (dissolved oxygen), with changes in soil temperature, and with the activity of many micro-organisms.

***Assessment of degradation degree of the wooden remains (Zborowska, 2007)***

On the basis of the assessment of degradation degree of the objects excavated from station 4 in Biskupin it was observed that they are significantly different with respect to their condition of preservation. Mass loss, which is one of the most often determined properties of archaeological wood, in the case of the analysed materials ranged from 1.9 % to 79.0%. Similar discrepancies were noted while testing the chemical composition, e.g. in the tested objects the percentage share of cellulose, a component determining strength properties of wood tissue, changed within a broad scope ranging from 13% to 48%.

The diverse degradation degrees of wooden relics of Lusatian Culture stemming from the variety and changeability of biotic and abiotic factors confirm the necessity for constant control of the condition of preservation of the historic tissue.

Relationship between the mass loss (UM) and the content of lignin (L) and holocellulose (H) of the investigated archaeological wood (fig. 3) shows that together with developing of mass loss content of polysaccharides decreases and proportion of resistant lignin increases.

#### 4. Conclusions

Investigations performed on the archaeological site no. 4 in Biskupin gave the unique possibility to analyse the wood from the most valuable Polish relics. Investigations allowed the comparison of chemical composition of different species of wood, covered with wet peat from one archaeological object, which had been degrading for the last 2700 years. Additionally, the complex analysis of deposition conditions of the wooden remains revealed that antique material stays in safe conditions, which limits the degradations of the wood. Authors hope that the described investigations will indicate range and direction of further works on the site, which guarantee an effective protection of wood relics for the next generations.

#### Acknowledgements

This research was founded by the Ministry of Scientific Research and Information Technology (the State Committee for Scientific Research, project number 2P06L00527).

#### Reference

- Babiński, L., Zborowska, M., Gajewska, J., Waliszewska, B., Prądyński, W. (2006): Decomposition of the contemporary oak wood (*Quercus* sp.) in conditions of the wet archaeological site in Biskupin. *Folia Forestalia Polonica Seria B – Drzewnictwo* 37, 9-21. ISSN-0071-6685.
- Bibiński, L., Fejfer, M., Prądyński, W. (2007): Environmental monitoring at the Lusatian culture settlement in Biskupin, Poland. *Journal of Wetland Archeology* 7, 51-72.
- Piotrowska, D. (1999): Wykopiska biskupińskie w archeologii i kulturze polskiej XX wieku. In: *Drewno archeologiczne- Badania i konserwacja, Sympozjum Biskupin – Wenecja 1999*, red. Babiński L., SNAP, Biskupin 11 – 28.
- Zborowska, M., Babiński, L., Gajewska, J., Waliszewska, B., Prądyński, W. (2007): Physical and chemical properties of contemporary pine wood (*Pinus sylvestris* L.) in conditions of a wet archaeological site in Biskupin. *Folia Forestalia Polonica, Seria B – Drzewnictwo* 38, 13 – 26. ISSN-0071-6685.
- Zborowska, M., Babiński, L., Prądyński, W., Waliszewska W. (2007): Pozostałości kultury łużyckiej w Biskupinie - monitoring i stan zachowania, in press.
- Ważny, T. (1993): Dendrochronological dating of the Lusatian culture settlement at Biskupin, Poland – first results. *NewsWARP* 14, 3-5.



*Red:* Measuring stations (MS1-MS6)

*Yellow:* Places of archeological wood excavation

*Blue:* Places where archeological and contemporary wood as well as cellulose pulp were reburied

The stations were established in the region that has not undergone archeological excavations yet (MS1-MS2), as well as in the areas in which some excavation has taken place followed by back-filling with sand (MS3), soil (MS5), or left uncovered, letting them fill up with water (MS4, MS6).

Figure 1. Plan of the archeological excavations at site no. 4 in Biskupin in the years 1934-1974 (according to Anna Drzewicz) with locations of measuring stations, places of archeological wood excavation and reburial of new organic material samples.

Table 1. Percentage content of major content, extractive substances and mineral components in contemporary oak and pine wood buried for two years from neighbourhood of measuring stations MS1 and MS4 at the Biskupin site.

		Oak			Pine		
		Control	MS1	MS4	Control	MS1	MS4
Holocellulose (H)	%	66.40	66.20	64.92	72.28	71.05	69.40
Cellulose (C)	%	38.54	36.56	36.30	48.67	47.78	46.76
Lignin (L)	%	25.98	26.89	28.37	27.98	28.46	30.06
H/L ratio		2.56	2.46	2.29	2.58	2.50	2.31
C/L ratio		1.48	1.36	1.28	1.74	1.68	1.56
Substances soluble in:							
Alkohol – benzen mixture	%	3.49	2.50	2.58	2.64	1.07	1.25
Cold water	%	4.92	3.02	4.50	1.89	0.67	0.73
Hot water	%	9.78	7.7	8.3	1.20	1.08	1.35
Ash	%	1.07	1.11	1.17	0.40	0.70	0.65



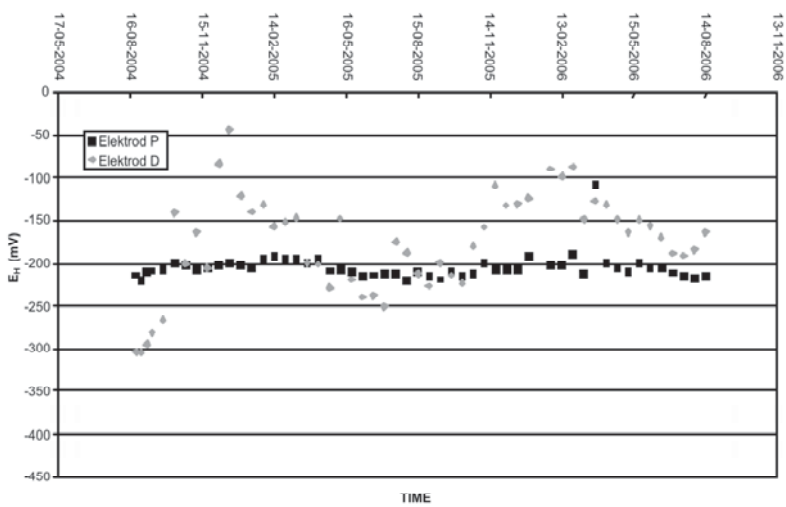

Figure 2. Changes in redox potential (Eh) at the depth of 100cm at measuring station MS2 depending on the used platinum electrodes (P - with platinum ring, D - Faulkner electrodes) in period from August 2004 to August 2006

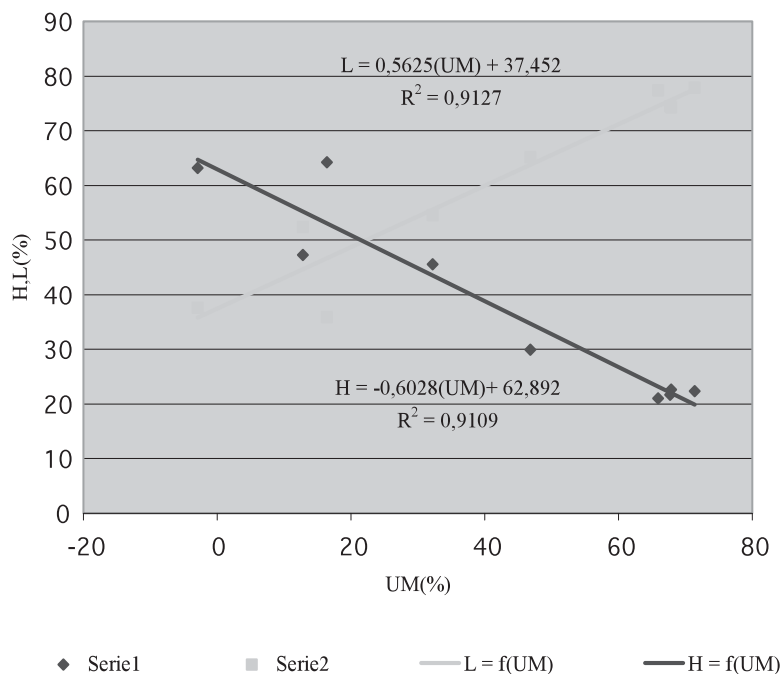

Figure 3. Dependence of the content of lignin (L) and holocellulose (H) versus mass loss (UM) in the archeological wood excavated in Biskupin.

**SESSION MANAGED BY WG2**



# OPTICAL TECHNIQUES IN WOODEN PAINTINGS DIAGNOSTICS

*Dario Ambrosini*

DIMEG, University of L'Aquila, Italy

dario.ambrosini@ing.univaq.it

## **Abstract**

Optical techniques, transferred from other fields or developed ad hoc, can be successfully used in diagnosing wooden paintings. The state of the art and the evolution of different optical non destructive techniques, such as holographic interferometry, electronic speckle pattern interferometry (ESPI), shearography and speckle decorrelation are considered. Some open problems and personal viewpoints are included as well as considerations on some recent developments and future trends.

## **1. Introduction**

All paintings age, changing therefore their appearance during time [1]. This process affects both painting layers and support. Furthermore, damages can be due to transportation, previous restoration, display and environmental conditions [1], including relatively-recent born problems, such as indoor heating [2].

Optical techniques represent versatile and attractive tools for painting diagnostics. One of the most important features of optical methods resides in their non-contact nature of carrying out measurements.

Optical techniques in painting diagnostics can be roughly divided in two groups:

1. "enhanced" visual techniques, involving multispectral inspection, such as X-radiography and infrared reflectography and ultraviolet fluorescence;
2. optical coherent techniques, involving the use of laser light sources, such as holographic interferometry and speckle techniques.

X-radiography, UV and IR techniques are well known and widely used [3]. They give information about hidden structures (X-radiography), invisible features such as preparatory drawings (IR reflectography) and about the surface condition (UV fluorescence).

Optical coherent techniques are more recent and not so widely used. First application of holographic interferometry in painting diagnostics dates back to 1974 [4].

Although holographic interferometry sensitivity and image quality are probably unrivalled, its inherent shortcomings (complexity, costs etc.) prevented a large diffusion of the technique in restoration practice and motivated the search for alternative coherent techniques.

The evolution of some optical coherent techniques for wooden painting diagnostics is described in [5].

In the following, basic principles of some techniques are described, clarifying advantages and disadvantages; personal viewpoints are included as well as considerations on some recent developments and trends.

## **2. Wooden Paintings**

Wood panels were largely used as supports in European paintings until the 17th century.

A painting on wood is a complex structure, composed by wood, canvas, preparation with gesso and glue, painting layer and varnish [6], which can be described as a multilayer system (Figure 1).

Over time this composite deteriorates, mainly because of temperature and/or humidity changes, to which the wood is very sensitive. Different expansions and contractions experienced by different regions of the support lead to anisotropic deformations, amplified by natural aging, which can alter the mechanical properties of each layer and eventually lead to the formation of detachments and cracks. Layer separation may occur at all levels in the paintings: sometime separation within layers may not be detectable without analytical tools (i.e. only using traditional methods, such as careful tapping).

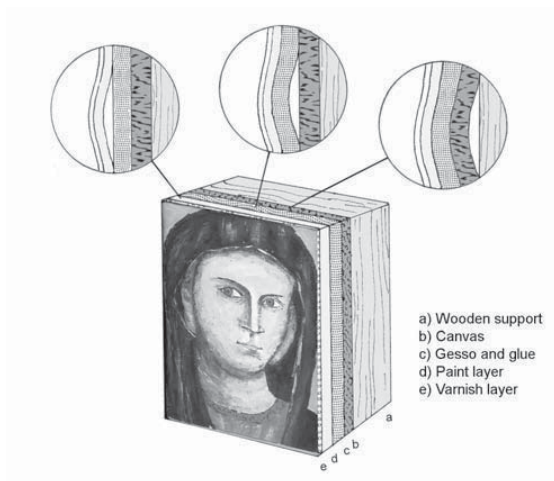

Fig. 1. Most frequent layer separations in a wooden painting layered structure.

The complexity of wooden paintings conservation is also due to a number of special factors such as their non-homogeneous, multilayer constitution; the fact that “artistic content” of wooden paintings constitutes a very thin layer, which is also interface between environment and support. A very important problem in artwork diagnostics concerns the identification of defects at an early stage.

### 3. Holographic interferometry techniques

Holography is a technique for recording and reconstructing light waves, introduced by Dennis Gabor in 1948 [7]. Holographic interferometry is a well-known non-destructive testing technique [8], which makes possible to map the displacements of a relative rough surface with an accuracy of a fraction of a micron. Since 1974 it has been used as a diagnostic tool on a variety of works of art. In the following, the main features of the techniques are summarised: interested readers may check existing reviews for further details [5, 9-11].

Holographic interferometry, which basically involves the superposition of two holograms recorded at different states of the object, provides a three-dimensional image of the object under test covered with a readily interpretable fringe pattern. In fact if the object under study is changed or disturbed in some way during the hologram exposure or from one exposure to the next, then a pattern of “fringes” will appear on the image itself, making the object look striped. Fringes represent maps of the surface displacement and their deformation may locate defects (voids, detachments, and cracks), often at an incipient stage, as well as material discontinuities and areas of excessive mechanical stress. Holographic interferometry has three basic variations: single exposure (or real time), double exposure and sandwich holography.

Real time holography involves the recording of a conventional hologram of the investigated object and the live observation of the formation and evolution of the fringes. A single holographic exposure of the test object is recorded and developed. Then the hologram is replaced exactly in the same position in which it was recorded; when it is reconstructed with the identical reference beam used in the recording process, the virtual image is superimposed on the object. If, however, the shape of the object changes (very slightly), the actual object wave interferes with its holographic replica; the object appears covered by a pattern of fringes, which can be observed in real time.

In double exposure holographic interferometry two holograms are recorded on the same photographic plate, with each one capturing the object in a different state separated by a fixed time interval. In this technique information on intermediate states is lost but it is less critical than real-time holography, which requires an exact repositioning of the hologram with a precision in the order of fraction of a  $\mu\text{m}$ .

In sandwich holographic interferometry the two exposures are made on different plates which are, then, combined in a specially designed plate holder. The image, reconstructed from a sandwich hologram gives the same fringes of a conventional double exposure hologram but, by having the images on two different plates, it is possible to manipulate them and hence the fringe pattern. Practically, a continuous scanning of the specimen can be done by shifting the centre of maximum sensitivity of the fringe pattern in order to produce a clear display of a flaw, with a configuration that outlines the flaw and gives an approximate indication of its size and shape (see Figure 2). In our opinion this versatility of the sandwich hologram is of particular interest in art diagnostics. A detailed comparison of advantages and disadvantages of these three holographic interferometry techniques is given in [5].

Generally, artworks are analysed in thermal drift (with a short thermal irradiation which raises the surface temperature of some degrees) or in ambient drift (under ambient parameter variations). It seems that the thermal-drift method is considerably better in detecting detached regions.

Holographic interferometry can detect layer separation within wooden painting and can also be used as a monitoring tool during restoration and cleaning [9, 12].

In spite of the obvious advantages, holographic techniques have never been adopted in any widespread fashion by the conservators community, mainly due to high cost, time consuming processing, need of optically skilled operator and impractical use in situ.

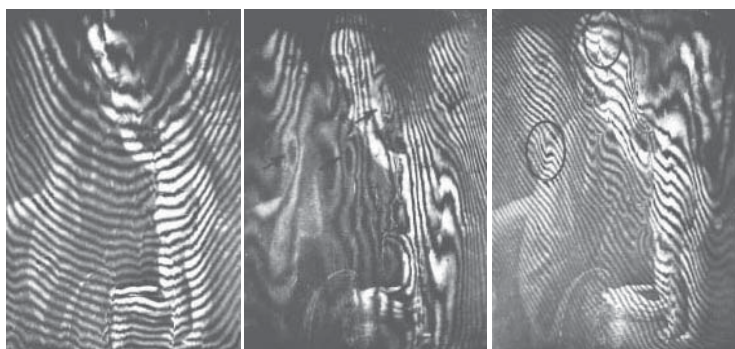

Fig. 2. Double exposure hologram (left) and two different sandwich holograms (giving different display of flaws) on the panel painting *Madonna col Bambino*, Perugia School, 15<sup>th</sup> century (Courtesy Prof. D. Paoletti).

#### 4. Speckle techniques

An interesting alternative to holographic interferometry is the use of speckle techniques.

A surface illuminated by laser light, appears covered by randomly distributed bright and dark spots or *speckles*. Initially considered only as noise, the harnessing of the speckle effect gave rise to a new branch of optical techniques, globally known as Speckle Metrology [13, 14].

Electronic Speckle Pattern Interferometry (ESPI) [5, 9, 14, 15] was developed in the early 1970s. Its experimental set up resembles holography, with the TV target replacing the glass plate as the recording medium. The reconstruction process is performed electronically within a computer.

In practice, the intensity distribution in the detector plane is stored with the object in its reference state. The object is then deformed and a second frame is stored.

The resulting fringes are similar in appearance to conventional holographic fringes but with a lower image quality, due to a much more evident speckle noise. For this reason, ESPI fringes are usually digitally treated for noise removal and contrast enhancement. Furthermore, due to the subtractive nature of the reconstruction process, many visible details of the artwork are lost and the precise location of the defect on the artwork can be difficult.

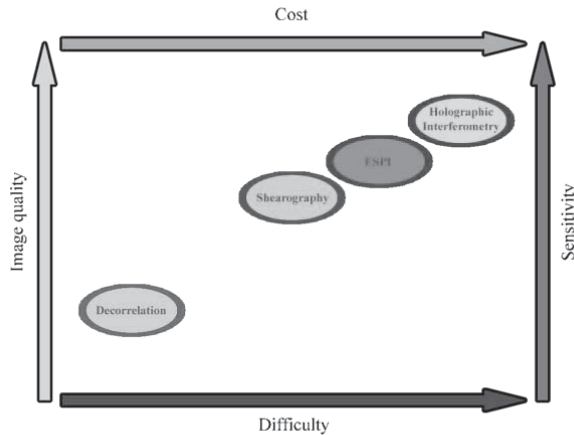

Fig. 3. Conceptual view of the main features of some optical coherent techniques.

An advantage of ESPI is the possibility to follow the displacement visually on the monitor and to save a suitable record at any time. By using narrow band filters, centred at the laser wavelength, ESPI systems can also operate in daylight conditions. It is then clear that, from an operational point of view, ESPI is faster and simpler to use than conventional holography.

ESPI has proved to be a very attractive tool, especially for *in situ* investigation, to monitor the works of art conditions over time as well as the real-object deformations due to microclimate variations [5, 9, 15].

Speckle shearography [16] is an interferometric method to measure displacement gradients at a surface. Its significant advantages with respect to holographic techniques are the simplicity of the optical setup, more tolerance to environmental disturbances and reduced resolution requirement of the recording medium.

The simplest shearography can be obtained by inserting a Fresnel biprism in front of the lens as shearing device. Shearograms are obtained, in practice, by subtracting two speckle patterns, sequentially recorded, with a deformation in-between. The resulting fringe patterns depict displacement derivatives with respect to the direction of image shearing.

We can roughly define the correlation between two speckle patterns as the capability to give fringes. Local correlation of laser speckles [5] consists of the evaluation of a local parameter that estimates the decorrelation of speckles after any modifications of the test object. Close correspondence exists between the object surface structure and the speckles in the image plane. For this reason, speckle correlation can characterize any physical or chemical mechanism that involves a surface alteration of the order of laser wavelength. To obtain the correlation pattern corresponding to the deformation field, two images are acquired and stored before and after the deformation. Then a digital subtraction between these two images is performed.

If the two images are perfectly correlated, they will cancel completely when subtracted; if there is some decorrelation, the subtraction will not be complete. Therefore, where non-correlation occurs, bright areas are visible, indicating the presence of defects.

Decorrelation has less sensitivity and image quality than holographic techniques and ESPI but it is comparatively cheap and simple.

## 5. Recent developments and trends

Fringe projection techniques usually address a different problem, the so-called optical contouring *i.e.* the analytical measurement of object shape [17, 18].

Optical contouring can be performed, as an example, by holographic methods, ESPI or fringe projection. The last technique is particularly interesting in the artwork conservation field because of its simplicity and low cost. The obtained data can serve as a quantitative record of museum objects as well as a monitoring over time of deterioration phenomena.

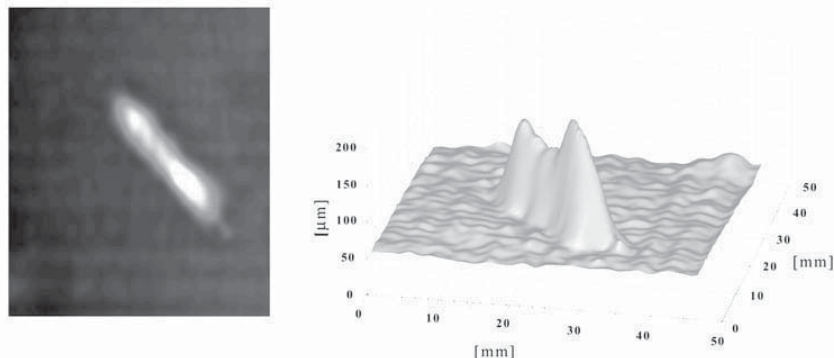

Fig. 4. Deformation phase map and 3D plot of a detached area on a wooden panel inspected by fringe projection in situ in the museum [19].

An interesting working system is based on a diffractive optical element (DOE) interferometer for 3D profilometry. Structured light (i.e. a sinusoidal fringe pattern) is obtained by the interference of the two fields diffracted by a saw-tooth phase grating. High contrast projected fringes are obtained, as the two beams have approximately the same intensity.

The fringe patterns, distorted by the surface roughness, are captured by a high-resolution CMOS image sensor. Recently, it was demonstrated that this contouring method can also be used for diagnostics purposes, revealing layer separation (see Figure 4) and cracks [19].

Much research effort was also devoted to improve existing techniques. Shearography can be combined in a single equipment with digital speckle photography to obtain full characterization of surface strain [20] or included in a multi-functional sensor, capable to work on panel paintings and canvas [21].

The integration of different techniques, often in a portable equipment, was proposed by different research groups in last years [22-25] to alleviate the drawbacks of a single diagnostic method.

Finally, a very recent trend is the application of OCT (Optical Coherent Tomography), an interferometric technique developed mainly for in vivo imaging of biological tissues, to the examination of paintings.

This technique is similar to ultrasound, being a cross sectional imaging modality, which measures echo time delays of backreflected light; it is non contact and non invasive and has a very high sensitivity [26-30]. The development of OCT instruments and some applications in the artwork field are described in [30].

OCT, which uses near infrared light (typically 700 – 1400 nm) of low temporal coherence, can penetrate the materials and thus show the in-depth structure of paintings as well as reveal the underdrawings and their depth positions [28].

3D-OCT was found to provide a more flexible and comprehensive analysis on paintings, with respect to high resolution infrared photography, at cost of more complex instrumentation and data processing [28].

Therefore, for highly transparent paint layers, the use of IR photography can still be suggested because of comparable performance, larger field of view, easy of use and rapidity [29].

Imaging NDT will continue to share advantages from the current diffusion of multimedia technology and development of effective electronic imaging tools, therefore we may expect their performance to grow further in the near future.



## References

1. Nicolaus, K. (1998): "The Restoration of Paintings". Konemann, Cologne.
2. Bratasz, L., Kozłowski, R., Camuffo, D., and Pagan, E. (2007): Impact of indoor heating on painted wood. *Stud. Conser.* 52: 199-210.
3. Byrne, A. (1996): The structure beneath. In S. Wallace, J. Macnaughtan and J. Parvey (eds), "The articulate surface: dialogues on paintings between conservators, curators and art historians". Humanities Research Centre, Australian National Universities.
4. Amadesi, S., Gori, F., Grella, R., and Guattari, G. (1974): Holographic methods for painting diagnostics. *Appl. Opt.* 13: 2009-2013.
5. Ambrosini, D. and Paoletti, D. (2004). Holographic and speckle methods for the analysis of panel paintings. Developments since the early 1970s. *Reviews in Conservation* 5: 38-48.
6. Cennini, C. (2003). "Il libro dell'arte". Neri Pozza, Vicenza.
7. Gabor, D. (1948): A new microscopic principle. *Nature* 161: 777 – 778.
8. Vest, C.M. (1979). "Holographic Interferometry". Wiley, New York.
9. Paoletti, D., and Schirripa Spagnolo, G. (1996): Interferometric methods for artwork diagnostics. In E Wolf (ed), "Progress in Optics", Vol. XXXV. Elsevier, Amsterdam 197-255.
10. Paoletti, D., Schirripa Spagnolo, G. and D'Altorio, A. (1989): The state of art of holographic non destructive testing in work of art diagnostics. *Revue Phys. Appl.* 24: 389-399.
11. Tornari, V. (2006): Optical and digital holographic interferometry applied in art conservation structural diagnosis. *e-Preservation Science* 3: 51-57. Available at <http://www.morana-rted.com/e-preservation-science/index.html>.
12. Tornari, V., Bonarou, A., Zafropoulos, V., Fotakis, C., Smyrnakis, N., and Stassinopoulos, S. (2003): Structural evaluation of restoration processes with holographic diagnostic inspection. *J. Cult. Her.* 4: 347s-354s.
13. Sirohi, R.S. (1993). "Speckle Metrology". Marcel Dekker Inc., New York.
14. Rastogi, P.K. (ed.) (2000). "*Digital Speckle Pattern Interferometry & Related Techniques*". Wiley, New York.
15. Dulie-Barton, J., Dokos, L., Eastop, D., Lennard, F., Chambers, A.R., and Sahin, M. (2005): Deformation and strain measurement techniques for the inspection of damage in works of art. *Reviews in Conservation* 6: 63-73.
16. Steinchen, W. and Yang, L. (2003). "Digital Shearography". SPIE Press, Bellingham.
17. Pirodda, L. (1982): Shadow and projection moiré techniques for absolute or relative mapping of surface shapes. *Opt. Eng.* 21: 640-648.
18. Asundi, A. (2000): Digital moiré for deformation analysis. In P. K. Rastogi and D. Inaudi (eds) "Trends in Optical Nondestructive Testing and Inspection". Elsevier, Amsterdam.
19. Schirripa Spagnolo, G., Majo, R., Ambrosini, D., and Paoletti, D. (2003): Digital moiré by diffractive optical element for deformation analysis of ancient paintings. *J. Opt. A: Pure Appl. Opt.* 5: S146-S151.
20. Groves, R.M., Fu, S., James, S.W., and Tatam, R.P. (2005): Single-axis combined shearography and digital speckle photography instrument for full surface strain characterization. *Opt. Eng.* 44: 025602.
21. Groves, R.M., Osten, W., Doulgeridis, M., Kouloumpi, E., Green, T., Hackney, S., and Tornari, V. (2007): Shearography as part of a multi-functional sensor for the detection of signature features in movable cultural heritage. In C. Fotakis, L. Pezzati, R. Salimbeni (eds) "O3A: Optics for Art, Architecture and Archaeology", Munich, 20-22 June 2007. *Proc. SPIE* vol. 6618, paper n. 661810.
22. Schirripa Spagnolo, G., Ambrosini, D., and Paoletti, D. (1997): Image decorrelation for in situ diagnostics of wooden artifacts. *Appl. Opt.* 36: 8358-8362.
23. Tornari, V., Zafropoulos, V., Bonarou, A., Vainos, N.A., and Fotakis, C. (2000): Modern technology in artwork conservation: a laser-based approach for process control and evaluation. *Opt. Lasers Eng.* 34: 309-326.
24. Schirripa Spagnolo, G., Ambrosini, D., and Paoletti, D. (2001): Comparative study on the efficiency of some optical methods for artwork diagnostics. In Renzo Salimbeni (ed.), "Laser techniques and Systems in Art Conservation", Munich, 18-19 June 2001. *Proc. SPIE* vol. 4402.
25. Hirsch, K.D., Gülker, G., and Helmers, H. (2007): Checkup for aging artwork: optical tools to monitor mechanical behaviour. *Opt. Lasers Engin.* 45: 578-588.

26. Targowski, P., Rouba, B., Wojtkowski, M. and Kowalczyk, A. (2004): The application of optical coherence tomography to non-destructive examination of museum objects. *Stud. Conserv.* 49: 107-114.
27. Liang, H., Gomez Cid, M., Cucu, R.G., Dobre, G.M., Podoleanu, A. Gh., Pedro, J., and Saunders, D. (2005): *En-face* optical coherent tomography - a novel application of non-invasive imaging to art conservation. *Opt. Expr.* 13: 6133-6144.
28. Arecchi, T., Bellini, M., Corsi, C., Fontana, R., Materazzi, M., Pezzati, L. and Tortora, A. (2006): A new tool for painting diagnostics: optical coherence tomography. *Opt. Spectrosc.* 101: 23-26.
29. Adler, D.C., Stenger, J., Gorczynska, I., Lie, H., Hensick, T., Spronk, R., Wolohojian, S., Khandekar, N., Jiang, J.Y., Barry, S., Cable, A.E., Huber, R., and Fujimoto, J.G. (2007): Comparison of three-dimensional optical coherence tomography and high resolution photography for art conservation studies. *Opt. Expr.* 15: 15972-15986.
30. Targowski, P., Góra, M. and Wojtkowski, M. (2006): Optical Coherence Tomography for artwork diagnostics. *Laser Chem.* 2006: Article ID 35373, 11 pages.

# INFRARED IMAGING TECHNIQUES FOR THE STUDY OF PAINTINGS AND OTHER ARTWORK

*Hiltrud Brocke, Jochen Aderhold*

Fraunhofer Wilhelm Klauditz Institute for Wood Research (WKI), Braunschweig, Germany  
hiltrud.brocke@wki.fraunhofer.de

## Abstract

In the study and restoration of paintings on wood it is often desirable to examine the adhesion of the paint layers to the ground, pre-treatments of the wooden paint ground, and details of the several paint layers. Infrared imaging techniques have proven to be very useful for this task. Near infrared techniques are well established in the study of the various paint layers. Many details not visible to the eye can be made visible in this way, especially from layers which were applied before the final layer. Dedicated equipment for the application of this technique is available on the market. However, near infrared imaging can be made easier and more powerful by new developments such as spectral imaging. Active thermography on the other sides provides insight into the physical structure of the painting, especially into the adherence of the paint layers to the ground. Furthermore, some knowledge of the pre-treatment of the wooden paint ground can be gained. Another application is the detection and digitization of watermarks.

## 1. The infrared spectral range

As the name already implies, the infrared (IR) spectrum begins with the long-wave (red) end of the visible spectrum. It is divided in the near infrared (NIR, 0.78–3 μm), mid or thermal infrared (3–50 μm) and far infrared (> 50 μm). (The definitions can vary a little from author to author.) Terahertz (THz) radiation has by definition of course a frequency in the THz range and consequently a wavelength around 100 μm. Thus, THz radiation can be assumed to be a part of the far infrared spectrum.

### 1.1. NIR

The behaviour of NIR light is very similar to that of visible light. An advantage of this is that normal quartz optics can be used. As objects at room temperature emit virtually no thermal radiation in the NIR, external illumination is generally necessary for the study of objects. A major difference to the visible light is given by the fact that due to vibrational and rotational transitions many molecules containing hydrogen have characteristic NIR spectral lines which can be used as fingerprints.

### 1.2. Thermal IR

Any object with a temperature above 0K emits electromagnetic radiation. This is the so called Planck radiation described by the famous Planck Formula (Fig. 1):

$$M_{\lambda}^0 = \frac{C_1 \lambda^{-5}}{\exp(C_2 / \lambda T) - 1} \quad C_1 = 2\pi hc^2 \quad C_2 = hc / k_B \quad (1)$$

$M_{\lambda}^0$  is the radiation power (unit: W/m<sup>3</sup>) emitted by an ideal black radiator per area and per wavelength interval,  $\lambda$  is the wavelength, and T the absolute temperature. The constants  $C_1$  and  $C_2$  consist of h (Planck Constant), c (speed of light) and  $k_B$  (Boltzmann constant). Since  $M_{\lambda}^0$  depends on the temperature only for given wavelength, a measurement of  $M_{\lambda}^0$  can be used to determine the object's temperature. As can be seen, objects at room temperature emit a considerable amount of radiation in the thermal IR. However, real objects emit less thermal radiation than an ideal black radiator would do under the same conditions. This is generally described by a multiplicative factor called emissivity which can assume values between 0 and 1 and can depend on the wavelength and other parameters:

$$M^{\varepsilon}_{\lambda} = \varepsilon(\lambda) M^0_{\lambda} \quad (2)$$

$M^{\varepsilon}_{\lambda}$  is the radiation power emit by a real radiator per area and per wavelength interval and  $\varepsilon(\lambda)$  the emissivity, which can depend on the wavelength.

Optical properties of objects in the thermal IR can be very different from those in the visible range – for example, glass appears black and opaque, and some kinds of plastic become transparent. Therefore, special optics made from Ge, Si, ZnSe and suchlike are needed in the thermal IR.

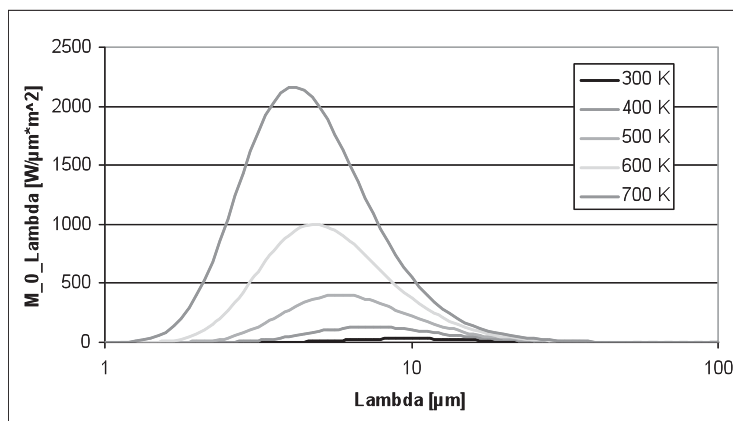

Fig. 1. Radiation power emit by an ideal black radiator

### 1.3. Terahertz Spectroscopy

While many parts of the far IR are not very useful for the kind of studies discussed in this paper due to atmospheric absorption, Terahertz spectroscopy is a promising new technique. First THz images of paintings are available which show that new of information can be obtained. A larger penetration depth is possible in comparison to other IR techniques, for example. But the problem is that a bright THz source in form of a femtosecond laser is needed which is very expensive. Furthermore, it still takes several hours to obtain a complete scan of a typical painting.

## 2. Infrared techniques useful in the study of paintings

### 2.1. Reflectometry

NIR reflectometry of paintings is known since 1931 at latest. In principle, it is not very different from the perception of a painting with the naked eye: It is illuminated with a suitable light source, and the reflected light is detected. Since the human eye is not sensible to NIR light, the reflected light has to be detected by technical equipment. The advantage of NIR reflectometry is that paint layers are often more transparent in the NIR than in the visible spectrum and exhibit less scattering (Fig. 2, left).

Consequently, NIR reflectometry literally allows a deeper insight into the preparation of the paint ground or into paint layers covered by the final layer. To get an idea of the different images in visible spectrum and NIR an example is given in Fig. 2 (right). It is a painting by Stephan Lochner (1440), Cologne Cathedral<sup>1</sup>. Reflectometry is also possible in the thermal IR but technically more difficult.

<sup>1</sup> Courtesy Landschaftsverband Rheinland, Rheinisches Amt für Denkmalpflege, Abtei Brauweiler, M. Thuns.

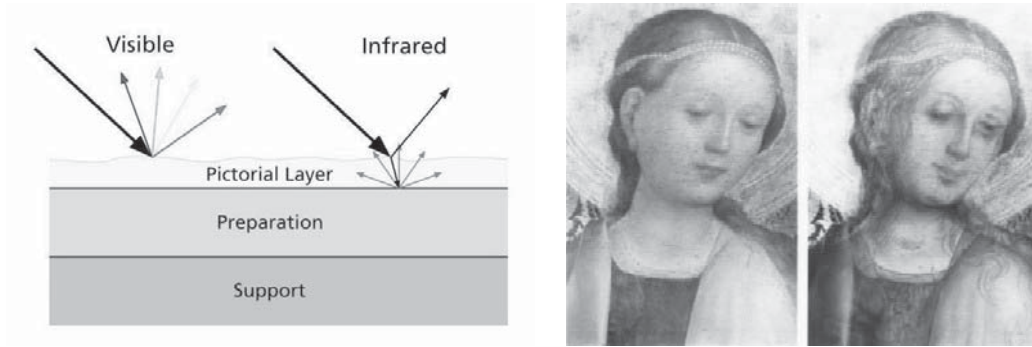

Fig. 2. Principle of NIR reflectometry (left) and example (right).

### 2.2. Active Heat Flow Thermography – Principle

Active heat flow thermography transfers differences in the thermal properties of an object under the surface such as thermal conductivity ( $\kappa$ ) and heat capacity ( $C$ ) into different surface temperatures. In such a way these can be made visible with an infrared imager. The object under study is subjected to a short heat pulse (Fig. 3) and subsequently observed with an infrared camera. If a defect with a low thermal conductivity such as a delamination is present, the heat flow into the object is retarded, and the defect is evidenced by a hot spot on the surface.

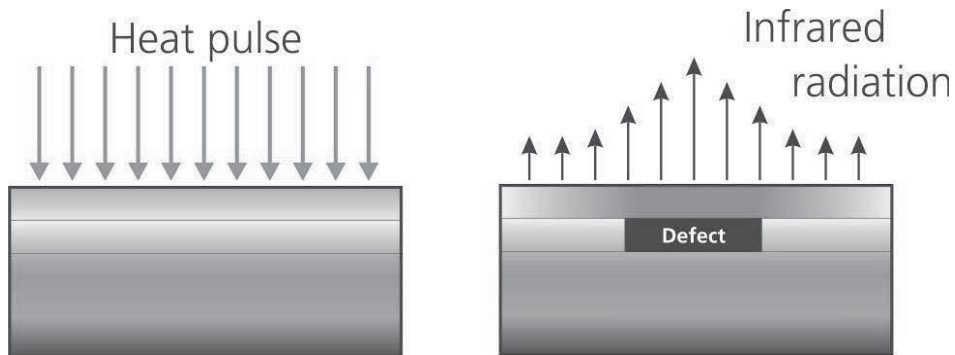

Fig. 3. Principle of active heat flow thermography.

## 3. Infrared imaging technology

### 3.2. NIR Cameras

Even commercially available CCD or CMOS cameras are applicable for NIR imaging. They are in principle sensitive up to a wavelength of  $1.1\mu\text{m}$ . The NIR spectrum is often blocked to avoid unwanted effects, such as an oversaturation of the red channel or a degradation of image quality due to chromatic aberration. Nevertheless, cameras with removable NIR blocker are available, a chance to get several megapixel at low price. They have a so called night shot mode. InGaAs cameras are available as line or matrix detectors. The line detectors have typically 1024 pixel with a working range of  $0.8\text{--}1.7\mu\text{m}$  or  $1.1\text{--}2.2\mu\text{m}$ . By contrast the matrix detectors have typically  $320 \times 256$  pixel. Vidicon cameras are PbS detectors with 700 lines and a range of  $0.4\text{--}2.2\mu\text{m}$ . They are less sensitive but cheaper than InGaAs cameras.

### 3.3. Multispectral Devices

#### 3.3.1. Multispectral Imaging

Conventional IR imaging techniques are panchromatic which means that every pixel records radiation over its complete sensitivity range. An example for panchromatic imaging is a normal black-and-white camera. In comparison to that in multispectral imaging the sensitivity range is separated into narrower bands such as red, green or blue by filters or dispersive elements. Then one image is taken for each of these narrow bands. Colour cameras work in this way.

Multispectral imaging is possible in the IR range as well. Especially when the object under study exhibits a spectrum with clear structures, more information can be obtained. In NIR, even chemical imaging could become possible. However, these techniques are more complicated and consequently more expensive. Also, more data have to be handled.

Many techniques have been applied to achieve multispectral imaging. It is possible to use more than one camera or a camera with more than one detector, each with a special filter. It is also possible to manufacture detectors which have an individual filter for each pixel (Bayer filters). A filter wheel is a cheap way to generate the desired multispectral image step by step. The most advanced techniques are line spectrographs and acousto-optical tunable filters.

#### 3.3.2. Spectral Imaging

A line spectrograph is a tool which converts any camera with a matrix detector into a multispectral line camera. It consists of a combination of prisms and gratings and is inserted between the objective and the matrix detector (Fig. 4). The light coming from a pixel in the target plane is split up spectrally and imaged onto a vertical detector line. In such a way, the image of a line in the target plane will fill the detector completely, resulting in a spectral image which contains the spectral information in the vertical axis and the spatial information in the horizontal direction. By scanning the object line by line, a complete spectrum of every point of the object's surface can be recorded, limited only by the pixel number of the detector (Fig. 5). Currently, line spectrographs are available for the visible, near infrared, and thermal infrared spectral range.

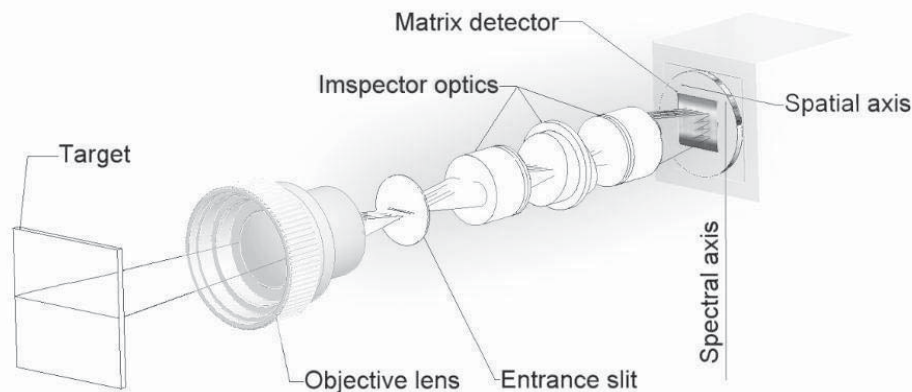

Fig. 4. Line spectrograph.

### 3.2 Thermography

#### 3.2.1. Thermography cameras

As can be taken from Fig. 1, thermography can in principle be done in the NIR or even in the visible range, but only for high temperatures ( $>700\text{K}$ ) since radiation intensities in these ranges are very low for lower temperatures. For temperatures around room temperature, two IR bands in the thermal infrared are of practical importance: the so-called mid wave IR band (MWIR,  $3\text{--}5\mu\text{m}$ )

and the long wave IR band (LWIR, 8–14  $\mu\text{m}$ ) where the atmospheric transmission is sufficiently high.

Generally, two types of detectors are used: band gap detectors and micro bolometer cameras. In band gap detectors, infrared photons cause an electrical signal by generation of electron-hole pairs in a semiconductor. Consequently, semiconductors with a sufficiently small band gap such as HgCdTe, InSb or GaAs-QWIPs are needed. These materials are generally technologically difficult to grow. In order to be able to distinguish between a signal and thermal noise, detectors have to be cooled down to temperatures around 90 K. In early times of thermography this was done with liquid nitrogen. Today, Stirling coolers are widely used. Cameras with cooled band gap detectors have typically 640 x 512 pixels and a noise equivalent temperature difference (NEDT) of around 15mK.

The operation principle of micro bolometer cameras is the change in electrical resistivity caused by the absorption of infrared photons in small silicon plates. They can be manufactured using standard silicon technology and need no cryogenic cooling but only temperature stabilization by Peltier coolers. Consequently, they are much cheaper than cooled band gap cameras. The pixel number of micro bolometer cameras is comparable to that of band gap cameras, their NEDT is around 70 mK.

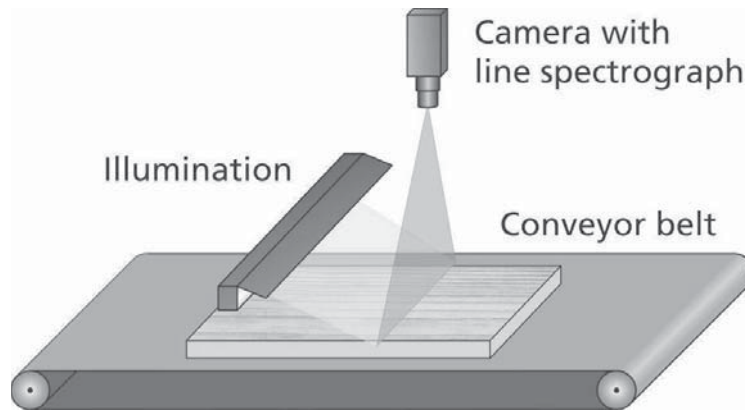

Fig. 5. Experimental Setup for Spectral Imaging.

### 3.2.2. Active Heat Flow Thermography – Experimental Setup

There are many ways to achieve the short heat pulse necessary in active heat flow thermography. Some authors use flashlamps for that purpose. For paintings, however, this is not the method of choice since the unavoidable ultraviolet photons could damage the paint layer. Therefore, a setup as described in Fig. 6 is more preferable. The object under study moves on a conveyor belt and passes an infrared heater so that a rise in surface temperature in the range of 2 °C is obtained. Afterwards, the cooling process is observed using an infrared camera.

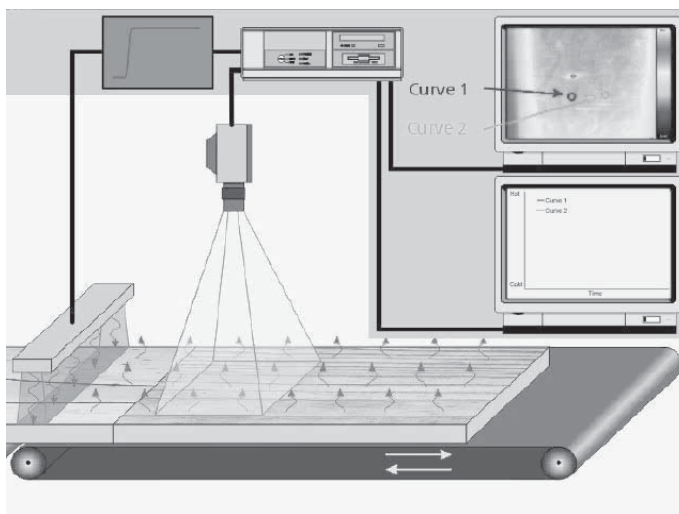

Fig. 6. Experimental Setup for Active Thermography.

#### 4. Examples: infrared thermography

##### 4.1. Infrared Thermography of Ukrainian Icons

Figure 7 shows some Ukrainian icons studied by active heat flow thermography which reveals information about the paint ground not obtainable by the naked eye: The infrared image of Figure 7a shows a chequered pattern. The glorioles appear black caused by the low emissivity of gold. In the infrared image of Figure 7b the wood structure and nails on the backside (black points) are visible. Bright white areas hint at delaminations. The infrared image of Figure 7c shows diagonal lines of the priming coat. While the background of Figure 7d is metallic gold, as evidenced by the dark appearance, the background of Figure 7c is not of metallic origin.

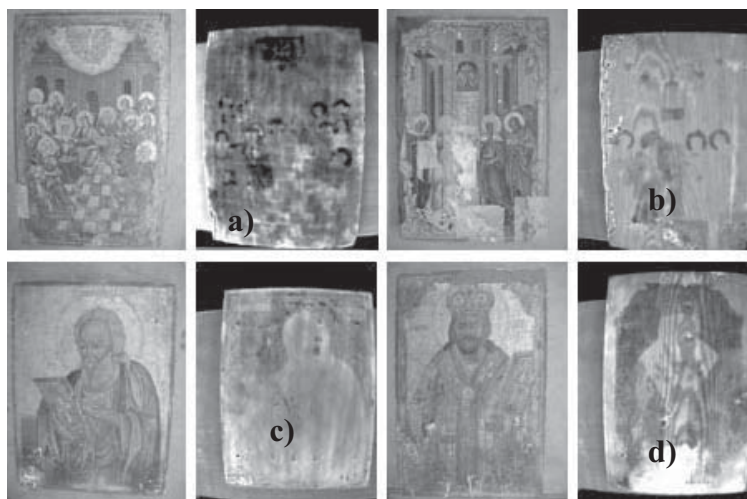

Fig. 7. Ukrainian Icons.



#### 4.2. Infrared Thermography of Hidden Watermarks

Historians are interested in watermarks as they include valuable information about origin and age of papers. However, watermarks are often covered by ink or paint which makes it difficult to digitize the watermarks or even to recognize them by the naked eye. In the thermal infrared region this problem can be overcome since paper and paint have almost the same emissivities so that they give no contrast. The watermark on the other hand can be distinguished from the surrounding paper by its lower thickness which affects heat capacity as well as infrared transmission. Both effects can be utilized to detect and digitize watermarks by thermography (Fig. 8, left). The central part of Fig. 8 shows a result obtained by bringing the paper into direct contact with a heating plate. However, better contrast can be achieved by observing the infrared radiation transmitted by the paper (Fig. 8, right). In this case, the heat plate serves as a source for infrared radiation.

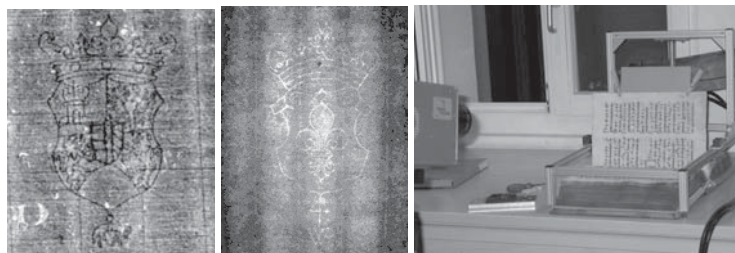

Fig. 8. Setup for watermark recognition (left) and thermal images of watermarks obtained by a setup using heat flow thermography (centre) and transmission thermography (right).

# DIAGNOSING WOOD ARTWORKS SURFACE THROUGH STATE-OF-THE-ART HIGH-RESOLUTION OPTICAL 3D IMAGING TECHNIQUES

*Jean Angelo Beraldin, Francois Blais, Marc Rioux*

Strategic initiative on 3D technologies for Cultural Heritage applications  
Visual Information Technology  
Institute for Information Technology  
National Research Council Canada  
Ottawa, Ontario, Canada  
angelo.beraldin@nrc-cnrc.gc.ca

Being unable to provide a Full Paper on the subject the Authors provided the following links to some papers that were used for the presentation.

## **A) 3D Technologies:**

Papers:

### 1) *Active 3D Sensing*

Authors: Beraldin, J.-A., Blais, F., Cournoyer, L., Godin, G., Rioux, M.

Source: *Modelli E Metodi per lo studio e la conservazione dell'architettura storica*, University:

Scuola Normale Superiore, Pisa. pp. 22-46, 2000

NRC Publication Number: NRC 44159.

<<http://nparc.cisti-icist.nrc-cnrc.gc.ca/npsi/ctrl?action=rtdoc&an=5764019&article=1&lang=en>>

### 2) *Review of 20 Years of Range Sensor Development*

Author: Blais, F.

Source: *Journal of Electronic Imaging*, 13(1): 231-240. January 2004.

NRC Publication Number: NRC 46531.

<<http://nparc.cisti-icist.nrc-cnrc.gc.ca/npsi/ctrl?action=rtdoc&an=5763160&article=0&lang=en>>

### 3) *Real-Time Interaction with Complex Models: Visualizing and Analyzing the Mona Lisa*

Author: L. Borgeat, G. Godin, P. Massicotte, G. Poirier, F. Blais, and J.-A. Beraldin.

Source: *IEEE CG&A* November/December 2007

A model of Leonardo da Vinci's Mona Lisa, with its thin pictorial layer, illustrates the need for intuitive real-time processing tools seamlessly integrated with a multiresolution visualization environment. Video Extra: "Visualizing and Analyzing the Mona Lisa" (104MB)

Paper and video can be found on IEEE web site.

## **B) Museum and Heritage Applications**

The NRC Institute for Information Technology (NRC-IIT) Visual Information Technology (VIT) Group has undertaken various Museum and Heritage Demonstration Projects in particular digitizing museum collections, paintings, sculptures, archaeological objects and sites as well as architectural and historic building elements.

<<http://www.nrc-cnrc.gc.ca/eng/programs/iit/modeling-visualization/3d-heritage.html>>

3D Examination of the Mona Lisa

<<http://www.nrc-cnrc.gc.ca/eng/projects/iit/mona-lisa.html>>

Museum Applications

<<http://www.nrc-cnrc.gc.ca/eng/ibp/iit/about/museum-applications.html>>

Remote Recording of Archaeological and Architectural Site Features

<<http://www.nrc-cnrc.gc.ca/eng/ibp/iit/about/archaeological-architectural.html>>

Some papers:

4) *NRC 3D Technology for Museum and Heritage Applications*

Author: Taylor, J., Beraldin, J.-A., Godin, G., Cournoyer, L., Baribeau, R., Blais, F., Rioux, M., Domey, J.

Source: *The Journal of Visualization and Computer Animation*, 14:(3), 2003.

<<http://nparc.cisti-icist.nrc-cnrc.gc.ca/npsi/ctrl?action=rtdoc&an=5765704&article=11&lang=en>>

5) *Active Optical 3-D Imaging for Heritage Applications*

Author: Godin, G., Beraldin, J.-A., Taylor, J., Cournoyer, L., Rioux, M., El-Hakim, S., Baribeau, R., Blais, F., Boulanger, P., Picard, M., Domey, J.

Source: *Proceedings of the IEEE Computer Graphics & Applications: Special Issue on Computer Graphics in Art History & Archaeology*, 22(5): 24-36. September/October 2002. ISSN 0272-1716.

6) *Ultra-High Resolution Imaging at 50µm using a Portable XYZ-RGB Color Laser Scanner*

Author: Blais, F., Taylor, J., Cournoyer, L., Picard, M., Borgeat, L., Dicaire, L.-G., Rioux, M., Beraldin, J.-A., Godin, G., Lahnanier, C., Aitken, G.

Source: *International Workshop on Recording, Modeling and Visualization of Cultural Heritage. Centro Stefano Franscini, Monte Verita. Ascona, Switzerland. (Invited). May 22-27, 2005. NRC Publication Number: NRC 48099.*

<<http://nparc.cisti-icist.nrc-cnrc.gc.ca/npsi/ctrl?action=rtdoc&an=5765101&article=0&lang=en>>

7) *Virtual Reconstruction of Heritage Sites: Opportunities and Challenges Created by 3D Technologies*

Author: Beraldin, J.-A., Picard, M., El-Hakim, S., Godin, G., Borgeat, L., Blais, F., Paquet, E., Rioux, M., Valzano, V., Bandiera, A.

Source: *International Workshop on Recording, Modeling and Visualization of Cultural Heritage. Ascona, Switzerland. (Invited). May 22-27, 2005.*

NRC Publication Number: NRC 48100.

<<http://nparc.cisti-icist.nrc-cnrc.gc.ca/npsi/ctrl?action=rtdoc&an=5764473&article=3&lang=en>>

8) *Integration of Laser Scanning and Close-Range Photogrammetry - The Last Decade and Beyond*

Author: Beraldin, J.-A.

Source: XXth Congress. *International Society for Photogrammetry and Remote Sensing. Istanbul, Turkey. July 12-23, 2004. Commission VII, pp. 972-983.*

NRC Publication Number: NRC 46567

<<http://nparc.cisti-icist.nrc-cnrc.gc.ca/npsi/ctrl?action=rtdoc&an=5765731&article=2&lang=en>>

9) *Accuracy Verification and Enhancement in 3D Modeling: Application to Donatello's Maddelena*

Author: Guidi, J.-A., Cioci, G., Atzeni, A., Beraldin, J.-A.

Source: *Proceedings of the Fourth International Conference on 3-D Digital Imaging and Modeling (3DIM). Banff, Alberta, Canada. October 6-10, 2003. pp. 334-341.*

NRC Publication Number: NRC 47082.

<<http://nparc.cisti-icist.nrc-cnrc.gc.ca/npsi/ctrl?action=rtdoc&an=8913776&article=4&lang=en>>

10) *An Assessment of Laser Range Measurement of Marble Surfaces*

Author: Godin, G., Beraldin, J.-A., Rioux, M., Levoy, M., Cournoyer, L.

Source: *Proceedings of the 5th Conference on Optical 3-D Measurement Techniques, Vienna, Austria. October 1-4, 2001. pp. 49-56*

NRC Publication Number: NRC 44210.

<<http://nparc.cisti-icist.nrc-cnrc.gc.ca/npsi/ctrl?action=rtdoc&an=5208716&article=1&lang=en>>

# MONITORING WOOD-DESTROYING INSECTS IN WOODEN CULTURAL HERITAGE

*Uwe Noldt*

Johann Heinrich von Thunen-Institute / Federal Research Institute for Rural Areas,  
Forestry and Fisheries (vTI)  
Institute of Wood Technology and Wood Biology (HTB)  
Hamburg, Germany  
uwe.noldt@vti.bund.de

## Abstract

Predominant wood-destroying insects of central Europe are beetles of the genera *Anobium*, *Xestobium* and *Coelostethus* (Anobiidae) and *Hylotrupes* (Cerambycidae). In long-term studies since 1999 in open air museums (in Germany and Latvia) and churches (e.g., Aachen Cathedral) different monitoring measures were applied. Light, sticky, pheromone and lure traps were used as arresting devices. Paper covers either glued or simply attached to wood surfaces demonstrate emergence of the insects. Beetle collection and frass analyses were employed to assess distribution and intensity of infestations in respective objects. Monitoring is only the initial step of integrated pest management (IPM) applied to wood-destroying insects. Appropriate control procedures of respective insect attacks in different objects is another issue. Examples of applied measures in wooden cultural heritage are presented.

## 1. Introduction

To date long-term investigations of the activity of wood-destroying insects in buildings have only been rarely conducted [1-5]. Monitoring these animals, which is defined as the determination of the density of the pest populations, has been intensively conducted in different projects – primarily in historic buildings (open –air museums, churches, mills, castles) as well as in collections and depositories – since 1999 [6-12]. These investigations by the Institute for Wood Biology and Protection at the Federal Research Centre for Forestry and Forest Products (BFH), which were performed in cooperation with the University of Hamburg and diverse other institutions, provided new insights into the biology and ecology of wood-destroying insects [13-15]. Additionally, conceptual procedures for the avoidance of wood damage in the context of integrated pest control were derived from this and control and prevention measures which had already been initiated were controlled for their success [16].



Fig. 1. Westphalian Open Air Museum Detmold; monitoring and control measures since 1999.



Fig. 2. Aachen Cathedral (Roofs).

Initially, the objective was to ascertain active insect infestation on building structures, wooden cultural objects and objects of art, as well as objects of everyday life made of wood. The observation of the infestation course and the estimation of the infestation intensity in the building [10], on the one hand, altar or picture frames [15], on the other hand, round out the respective picture. In cases involving massive destruction and an urgent need for action, the use of a chemical or thermal control measure or ultimately, for example, the demolition of a roof truss can be implemented. In contrast, long-term monitoring [7] – e.g., since 1999 in the more than 100 buildings of the Westphalian Open Air Museum Detmold (WFM) and subsequently in many other objects (Figs. 1, 2) – can involve a very differentiated procedure with regard to the classification of the infestation intensity, the decision-making process for control measures as well as for building hygiene. The fundamental knowledge of the biology and ecology of the wood-damaging insects as well as about their specific living conditions and their antagonists [16] which arose from the monitoring form the basis for the countermeasures that are to be initiated and the special object conditions which are to be strived for. The results of these long-term investigations by the Institute for Wood Biology and Protection at the BFH can subsequently be applied by both decision-makers at the competent institutions and on a small-scale by wood-processing firms and private individuals in a directed manner.

Historic buildings have, in part, been exposed to manifold destructive influences by humans, due to natural deterioration, resulting from material shrinkage, and, an important factor in the case of wood as a construction material, the destruction by organisms [17-23]. These damages are very frequently due to structural damage and constructive deficiencies. As a consequence of moistening of the wood, infestation by wood-destroying fungi and/or wood-destroying insects can occur.

The implementation of integrated pest management (IPM) [24,25], which has long been known from agriculture, forestry, and inventory management, only just began a few years ago in the case of wood-destroying organisms in a systematic manner [10]. Monitoring [2, 26-29], which comprises determination of the causative agent, type of damage and extent of damage, normally results in infestation mapping. If mass infestation is detected, an immediate decision for appropriate control or treatment measures is required. Parallel to this, considerations regarding restoration [9, 15], construction and repair measures which aim to change the environmental conditions to the disadvantage of the pest organism [30] should occur. They are, for example, avoidance and suppression of moisture permeation into the building, storage conditions of wooden objects beyond the moisture and temperature optima of the larvae in the wood, prevention of use of types of wood suitable for infestation, use of alternative infestation-resistant types of wood as well as elimination of structural deficiencies. Another important aspect of integrated pest control is training those responsible on the specific conditions and special features of monitoring, control and prevention of wood-destroying insects.

## 2. Characteristics Of Infestation

### 2.1 The wood-destroying insects

Nearly all of the insects present are originally wood or forest insects and now synanthropic species which have expanded their niche to include buildings and processed wooden objects [20, 22, 23]. The predator pressure in these “protected spaces” is much lower than in the field, even though there are also antagonists there, such as the chequered beetles (Cleridae; particularly *Korynetes coeruleus* De Geer; KC), parasitic wasps (Ichneumonidae) and diverse spiders [10, 14, 27, 28, 34]. The most important dry wood insects in our climates are the European house-borer (*Hylotrupes bajulus* (L.); HB), the death-watch beetle (*Xestobium rufovillosum* (De Geer); XR) and the common furniture beetle (*Anobium punctatum* (De Geer); AP), as well as the anobiid species *Coelostethus pertinax* (L.) (Tableau 1), which can seriously threaten the static of structural parts via their mass infestation – which in some cases can last for decades – or in the case of the furniture beetle, wooden objects of everyday use, sacral objects or agricultural devices up to pulverisation of the wooden material. For completeness sake, the group of the wood-destroying weevils (Cossoninae) in secondarily moistened structural wood as well as the wood-destroying ants with their nests in wood, which have become increasingly more frequent in the last few years, should be mentioned. Repeated mass infestations by representatives of the lyctus beetles (Lyctidae; particularly *Lyctus brunneus* (Stephens)), which are usually imported, have been reported. However, they now occur with increasing frequency in modern buildings [19].



Tableau 1 – Important wood-destroying insect species (from left to right in each case): adult(s), larvae; characteristic damaged piece). 1. House longhorn beetle, European house-borer (*Hylotrupes bajulus* (L.); HB); female; rafters. 2. Common furniture beetle, furniture beetle (*Anobium punctatum* (De Geer); AP); furniture piece. 3. Death-watch beetle (*Xestobium rufovillosum* (De Geer); XR); timber pillar.

## 2.2 The damages

The European house-borer is a longhorn beetle which is restricted to the sapwood of conifers [cf. 20, 22, 24]. The death watch beetle, which infests sapwood and heartwood, occurs primarily in oak which has previously been damaged by fungi, even though conifers are also infested. The common anobiid beetle (“furniture beetle” or “woodworm”) accepts both coniferous and deciduous tree species, whereas the lyctus beetles are specialized on hardwoods, particularly those of tropical origin. The degree of destruction caused by the larvae can be very different depending on whether it is referred to the respective wooden object, on the one hand, (Tableau 1) and the respective building, on the other hand, (Figs. 1, 2, 4, 6, 7). In buildings they can occur over a wide area or only in a locally restricted one. A determination of infestation based on leaking frass, fresh emergence holes and the finding of diverse insects frequently results, for reasons of lack of knowledge or deficient analytical expertise, in misinterpretations and inappropriate countermeasures, such as excessive use of wood preservatives or costly complete treatments although local measures would have been adequate.

## 3. Monitoring and long-term investigations

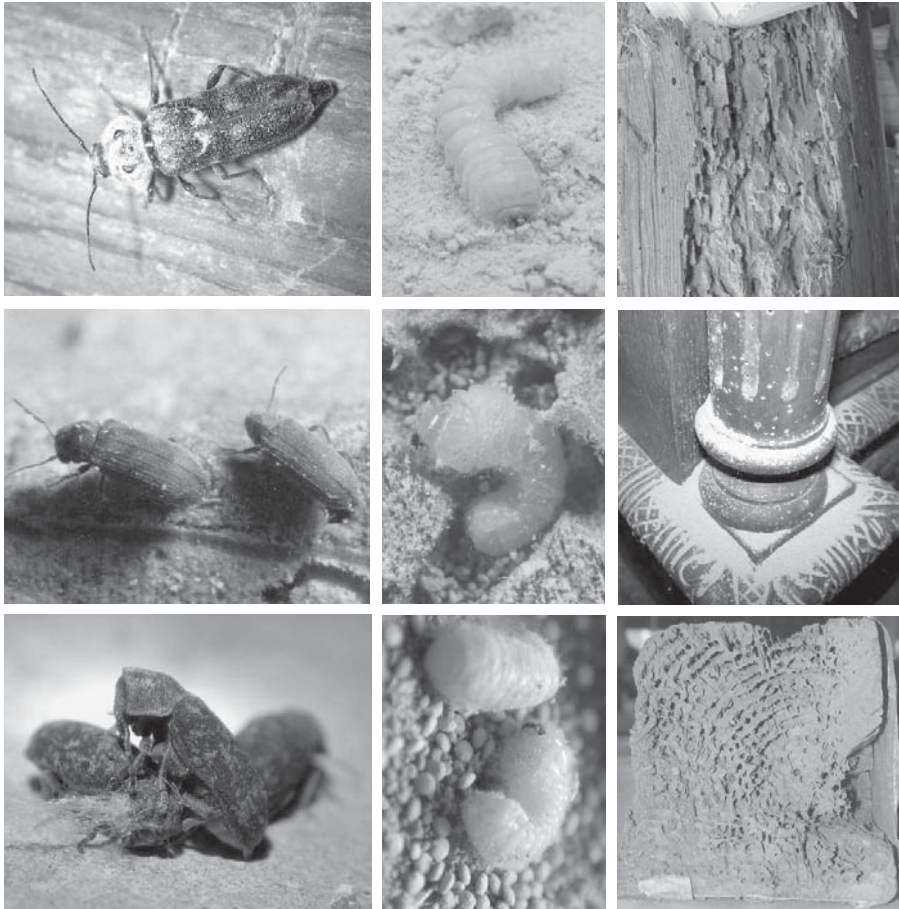
### 3.1 The objects

The first monitoring investigations occurred in open air museums [6, 11, 31], whereby the Westphalian Open Air Museum Detmold (WFM) and the Museum Village Bavarian Forest in Tittling/Passau (MBW), each with more than 100 individual buildings, have to be emphasized. Later, additional open-air museums (Haselünne, Schönberg, Klockenhagen, Gutach, Hermannstadt (Romania), Riga (Latvia); [9, 11, 17]), churches (Aachen Cathedral, Marienmünster Abbey Church, churches in Xanten, Kempen, Bernkastel-Kues, Mecklenburg-Vorpommern, Latvia, and Romania; [8, 15, 31]), castles, palaces and mills were investigated in cooperation with other institutions and experts [12, 15, 29, 30, 35]. Beyond this, studies on individual objects, such as objects of art in German collections and museums or historical chests in Schäßburg, Romania were conducted. In addition to the assessments of the actual insect damage and the monitoring measures employed in accordance with need and financial capability, in all cases conceptual proposals regarding control measures, storage and depository storage were worked out. They were implemented by our cooperation partners to different extents [10].

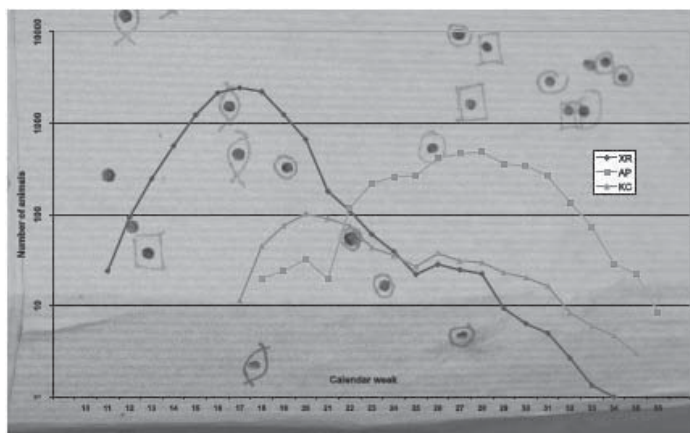

Fig. 3. Emergence through glued paper covers of death-watch beetle (*Xestobium rufovillosum* (De Geer); XR), common furniture beetle (*Anobium punctatum* (De Geer); AP), and antagonist steely blue beetle (*Korynetes coeruleus* De Geer; KC) in the years 2001 - 2005 according to calendar weeks.

### 3.2. The assessment

The infestation assessment in the buildings subsequent to initial extensive inspections and then subsequent to assessment of the monitoring measures described in the following were normally performed with a so-called “traffic-light assessment” [10]: “red” for mass infestation and absolute

need for action, “yellow” for intermediate infestation in the entire building and monitoring measures to be initiated, and “green” for old infestation or freedom from infestation [10]. This procedure was also implemented for the structural beams in the roof truss of the “Octogon” in the Aachen Cathedral or in stored wooden objects in the depositories of various other large objects. This “building-wise” infestation mapping or “structural part-/object-wise” categorisation of infestation was also repeated depending on the period of the investigation at intervals of 2 or 3 years or in an annual cycle in order to document the development, including post-monitoring subsequent to the performed control measures.

### 3.3. The monitoring measures

The monitoring measures [10] included the following procedures (Tableau 2): collecting, glued paper covers, light traps, sticky traps, hanging frames and hanging boxes, pheromone traps and extract traps, frass analyses as well as loose paper coverings.

From this mass of data, the assessment of the paper paste-overs with emergence holes for all buildings at the WFM Detmold is exemplarily presented for the years 2001–2005 (Fig. 3). Infestation mapping for the WFM and MBW Museums for two periods (2001, 2004) and the basic legend for the Ethnographic Museum in Riga for 2005 are available [10, 31].

As a result of the monitoring measures, it was possible, e.g., to achieve the following results and draw the following conclusions [10]: identification of the infestation focuses; annual cycles of eclosion for wood-destroyers and antagonists; mass collection of males before females (XR); multiple use of emergence holes by different individuals in the season and cross-seasonally (XR, AP); dispersal paths of marked animals (XR); temperature threshold value of the flying behaviour of XR confirmed; annual cycles with regard to predator-prey relationships; proof of inadequate craftsmen’s work (Aachen Cathedral); proof of control success in post-monitoring (XR, AP, KC); first approach flight of KC in treated building; attraction effect of light sources (XR, KC). Many of these results provide the basis for the targeted use of control measures and/or pheromone and extract traps as well as for current experiments with antagonists [34].



Tableau 2 - Monitoring measures (each row from left to right): 1. Collections: collected beetles per room and week, enclosed beetles. – Glued paper covers: pasted over ceiling beams, pasted surface 37 in House O1 (WFM), marked emergence hole of previous year (Haselünne). 2. Light traps: Light trap (Aachen Cathedral), detail of captured beetle (WFM). – Sticky pieces of cardboard: structural parts (Aachen Cathedral), detail in choir hall. 3. Hanging devices: hanging frame under ceiling beam, captured beetles. – Pheromone traps: use in MBW in Tittling, detail of trap.

### 4. Accompanying control measures

The work in museums and on the different funded projects with the involvement of industrial partners provided the possibility of monitoring the required control measures and of performing a neutral success control of these measures [8, 10, 16]. At the present time, the humidity-regulated

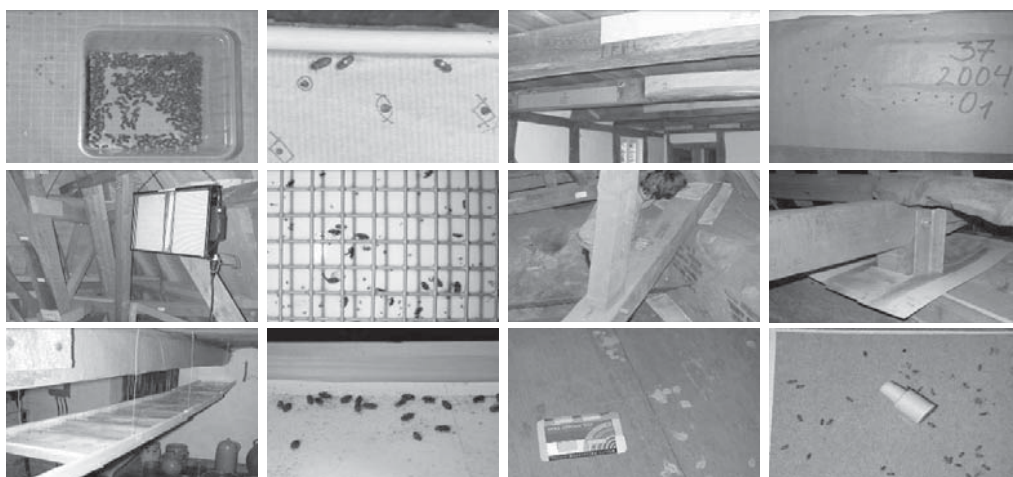

warm air method for entire buildings as well as the microwave procedure for structural units are being used, tested, and the procedural technique improved with regard to temperature minimisation, protection of the objects, energy expenditure and environmental damage [32, 33, 35]. In addition, since 1999 other control measures such as fumigations with carbon dioxide [32], methyl bromide and sulphuryl difluoride as well as the use of thermal chambers [33] for the treatment of movable objects have been scientifically monitored with regard to their control success. Besides the measuring instruments used (e.g. thermal probes, gas measuring instruments, etc.), monitoring these control measures by means of control blocks with living stages of the important of wood destroyers HB, XR, AP (plus LB), which were taken from field populations or the BFH's cultures, was conducted [10, 32, 33]. These small control blocks (Fig. 5) were placed in large control blocks whose sizes corresponded to those of the greatest dimensions of the structural parts or the furniture part, subjected to the treatments, and as a rule subsequently assessed with regard to the test animals mortality.

Conclusions about inadequate treatment parameters, weaknesses with regard to certain structural elements in the houses, inadequate heat distribution and/or leakages or differentiated parameters for the individual insect species or their developmental stages resulted from these accompaniments with control blocks. Furthermore, the lethal temperature of 55° C for at least one hour prescribed in the specifications in German/European standards could be experimentally confirmed by means of the process applications [36, 37].

### Acknowledgements

Thanks for the cooperation especially to: Andrea Niemeyer, Anne Wettich, Dorothea Martin-Klößner (BFH bzw. HTB im vTI); Jutta Lax, Bernd Ixmeyer, Britta Witt, Ralf Engelken, Silvia Koch, Raita-Maria Konttinen, Dörte Kreska, Gabriel Hartmann, Patrick Lenz (Hamburg University); Dr. Hubertus Michels, Daniel van't Hull, Oliver Junk (WFM Detmold); Helmut Maintz (Domkapitel Aachen); Dr. Alexander Niederfeilner (MBW Tittling); Tilo Haustein (Hochschule Wismar); Melanie Dropmann (FH Köln); Dr. Martins Kuplais, Dr. Bruno Andersons (Latvia); Ileana Chirtea, Dr. Livia Bucsa (Romania); Dr. Guna Noldt and Janis Adamsons.



Fig. 4. Humidity-regulated warm-air method of house J1 in WFM Detmold.

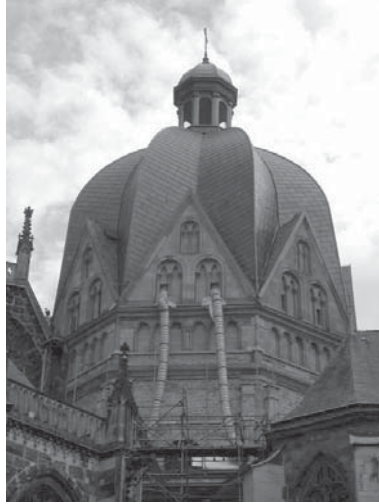

Fig. 5. Humidity-regulated warm-air method in the Octagon of Aachen Cathedral.



Fig. 6. Control blocks to monitor success (Aachen Cathedral).



Fig. 7. Fumigation of E4 Mill (WFM Detmold).

## References

1. Belmain, S.R. (1998): "Biology of the Death-watch Beetle (*Xestobium rufivillosum*). De Geer, (Coleoptera: Anobiidae)". University of London, PhD thesis: 214 pp.
2. Belmain, S.R., Blaney, W.M., Simmonds, M.S.J. (1999): Death-watch beetle, *Xestobium rufivillosum*. Historical buildings: monitoring the pest and its predators. *Entomologia Experimentalis et Applicata* 93: 97-104.
3. Belmain, S.R., Simmonds, M.S.J., Blaney, W.M. (2001): Life cycle and feeding habits – Beetle behaviour in buildings and boxes. Timber, The EC Woodcare Project. Ridout, B.V. (Ed.): 6-14.
4. Fisher, R.C. (1938): Studies of the biology of the death-watch beetle, *Xestobium rufivillosum* De Geer II. The habits of the adult with special reference to the factors affecting oviposition. *Annals of Applied Biology* 25: 155-180.
5. English Heritage (2001): "The EC Woodcare Project: Studies of the behaviour, interrelationships and management of death-watch beetles in historic buildings". Timber, Ridout, B.V. (Ed.). *English Heritage Research Transactions* 4: 114 pp.
6. Noldt, U. (2001): Holzzerstörende Insekten in Gebäuden eingeschleppt, eingebohrt und eingefangen – Praxisfälle und Monitoring. Venzmer, H. (Ed.). *Mauerwerksfeuchtigkeit*. Berlin, Verlag Bauwesen, Schriftenreihe H 12: 109-118.
7. Hubertus, M., Noldt, U. (2006): Kampf den Holzschädlingen im Fachwerk – Ein Forschungsprojekt im Freilichtmuseum Detmold. *Freilichtmagazin*. Mitteilungen aus dem LWL-Freilichtmuseum Detmold. 1: 58-69.
8. Noldt, U. (2006): Holzzerstörende Insekten – Befallsmerkmale, Monitoring, Langzeituntersuchungen und Begleitung von Bekämpfungsmaßnahmen in historischen Gebäuden. *Forschungsreport* 2: 33-37.
9. Klopfer, R., Noldt, U., Kiefl, K., Steinbach, S., Wings, G., von Rotberg, W. Pressler, E. (2005): Erarbeitung und Umsetzung beispielhafter Lösungswege zum vorbeugenden Holzschutz an zwei national wertvollen Fachwerkhäusern des Heimatvereins Haselünne e.V., einschließlich Schädlingsbekämpfung. *Abschlußbericht DBU-Projekt 20133*: 73.
10. Noldt, U. (2007): Monitoring von holzzerstörenden Insekten – Anforderungen und erste Ergebnisse. *Holzschädlinge im Fokus – Alternative Maßnahmen zur Erhaltung historischer Gebäude*. Noldt, U., Michels, H. (Ed.). Detmold: *Schriften des LWL-Freilichtmuseums Detmold* 27: 41-57.
11. Noldt, U., Schönhoff, T., Michels, H. (2003): Beispiele und Anforderungen zum Monitoring von Schadinsekten. *Tagungsband 23. Holzschutz-Tagung der DGfH, Augsburg*: 71-81.
12. Hausteil, T., von Laar, C., Noldt, U. (2006): Holzzerstörende Insekten in Bauwerken und an Kulturgut. *Insekten-Monitoring in Mecklenburg-Vorpommern*. Der Bausachverständige 1: 26-29.
13. Noldt, U., Michels, H. (ed.) (2007): Holzschädlinge im Fokus – Alternative Maßnahmen zur Erhaltung historischer Gebäude. (Beiträge der internationalen Tagung im LWL-Freilichtmuseum Detmold/ Westfälisches Landesmuseum für Volkskunde.) Detmold: *Schriften des LWL-Freilichtmuseums Detmold* 27: 265 pp.
14. Hausteil, T., von Laar, C., Noldt, U. (2007): Diagnose Holz zerstörender Insekten und ihrer natürlichen Feinde in historischen Gebäuden Mecklenburgs. *WTA-Almanach*: 579-606.
15. M., Waentig, F., Noldt, U. (2007): Möglichkeiten und Grenzen des Monitorings von holzzerstörenden Insekten an Kunst- und Kulturgut – Abteikirche Marienmünster. *Holzschädlinge im Fokus – Alternative Maßnahmen zur Erhaltung historischer Gebäude*. Noldt, U., Michels, H. (Ed.). Detmold: *Schriften des LWL-Freilichtmuseums Detmold* 27: 83-90.
16. Noldt, U. (2007): Begleitung von Bekämpfungsmaßnahmen gegen holzzerstörende Insekten und deren Erfolgskontrolle. *WTA Almanach*. Gänßmantel, J, Hecht, C (Ed.). München: WTA-Publications: 627-644.
17. Ridout, B.V. (2000): "Timber Decay in Buildings and its Treatment: The Conservation Approach". Routledge, London: 232 pp.
18. Huckfeldt, T. (2007): Typische Schäden an Fachwerk. *WTA-Journal, Internationales Journal für Technologie und Praxis der Bauwerkserhaltung und Denkmalspflege* 3: 347-367

19. Noldt, U. (2000): Holzzerstörende Insekten – Fälle von gestern, Forschung von heute, gefahren von morgen. Forschungsreport 1: 24-28.
20. Noldt, U. (2005): "Holzinsekten. In. Holzschutz im Hochbau". (Ed. Müller, J.). Fraunhofer IRB-Verlag, Stuttgart: 73-100.
21. Cymorek, S. (1984): Schadinsekten in Kunstwerken und Antiquitäten aus Holz in Europa. Holzschutz-Forschung und Praxis, Symposium 1982 im Forschungs- und Entwicklungszentrum Krefeld, Kommissionsverlag, DRW-Verlag Weinbrenner-KG, Leinfelden-Echterdingen: 37-56.
22. Sutter, H.-P. (2002): Holzschädlinge an Kulturgütern erkennen und bekämpfen - Handbuch für Denkmalspflege, Restauratoren, Konservatoren, Architekten und Holzfachleute. Verlag Paul Haupt, Bern/Stuttgart: 166 pp.
23. Grosser, D. (1985): Pflanzliche und tierische Bau- und Werkholz-Schädlinge. DRW-Verlag Weinbrenner-KG, Leinfelden-Echterdingen: 159 S.
24. Pinniger, D.B. (2001): "Pest management in museums, archives and historic houses". Archetype Publications Ltd., London: 115 pp.
25. Simmonds, M.S.J., Belmain, S.R., Blaney, W.M. (2001): Integrated pest management for the control of death-watch beetles (Trapping). Timber, The EC Woodcare Project. Ridout, B.V. (Ed.): 40-51.
26. Ridout, B.V. (2001): Death-watch beetle and its treatment Conclusions and some practical results from the Woodcare research programme. Timber The EC Woodcare Project. Ridout, B.V. (Ed.): 3-5.
27. Ott, R. (2006): Spurensuche. Untersuchungen über die Entstehung von Bohrmehlhäufchen an Schlupflöchern des gemeinen Nagekäfers (*Anobium punctatum*). De Geer, <<http://www.Holzfragen.de/>>.
28. Paul, F. (2007): "Anwendung verschiedener Elemente des 'Integrierten Holzschutzes' am Beispiel der Bekämpfung von *Anobium punctatum* in der Allerheiligenkirche zu Erfurt." Diploma thesis, FH Eberswalde: 71 pp.
29. Rentrop, R., Stolze, S. (2005): "Studien zum Ausschupfverhalten des Gescheckten Nagekäfers (*Xestobium rufovillosum* [De Geer]) im Westfälischen Freilichtmuseum Detmold." Diploma thesis, FH Lippe und Höxter: 100 pp.
30. Michels, H. (2007): Das Monitoring-Gebäude Kayser-Henke – Holzfeuchtemessungen und Temperierung. Holzschädlinge im Fokus – Alternative Maßnahmen zur Erhaltung historischer Gebäude. Uwe Noldt, Hubertus Michels (Ed.). Detmold: Schriften des LWL-Freilichtmuseums Detmold, 27: 241-252.
31. Noldt, G., Noldt, U., Andersone, I., Andersons, B. (2007): Koksnes kaitekli kulturas piemineklos (Holzschädlinge an Kulturdenkmälern). Vides Vestis 4/99: 56-59.
32. Noldt, U. (2007): Bekämpfung von Holzinsekten im Zentralmagazin des LWL-Freilichtmuseums Detmold: Kohlendioxid-Begasung und Thermokammerbehandlung. Vorsicht Objekte – Neue Ansätze im Umgang mit originalen Einrichtungen in Freilichtmuseen. Schlimmgen-Ehmke, K. (Ed.). Materialien des LWL-Freilichtmuseums Detmold 4: 85-97.
33. Noldt, U. (2007): Niederfeilner, A.. Anwendung der stationären Thermokammer und Erfolgskontrolle. Holzschädlinge im Fokus – Alternative Maßnahmen zur Erhaltung historischer Gebäude. Noldt, U., Michels, H. (Ed.). Detmold: Schriften des LWL-Freilichtmuseums Detmold, 27: 125-136.
34. Noldt, U., Engelken, R. (2008 ): (unpubl.) Biology and ecology of antagonists of the anobiid beetles." Diploma thesis.
35. Schachenhofer, B. (2007): Feuchtereguliertes Warmluftverfahren zur Insektenbekämpfung. WTA Almanach 2007. Gänßmantel, J, Hecht, C (Ed.). München: WTA-Publications: 369-380.
36. DIN 68800-4 (1992): Holzschutz – Bekämpfungsmaßnahmen gegen holzerstörende Pilze und Insekten. Beuth Verlag GmbH, Berlin: 7 pp. + DIN/DGfH (1998): Beuth-Kommentare Holzschutz baulich-chemisch-bekämpfend-Erläuterungen zu DIN 68800-2,-3,-4. Beuth Verlag GmbH, Berlin/Wien/Zürich: 202 pp.
37. WTA-Merkblatt E 1-1-06/D (2007): Heißluftverfahren zur Bekämpfung tierischer Holzzerstörer in Bauwerken. Wissenschaftlich-Technische Arbeitsgemeinschaft für Bauwerkserhaltung und Denkmalpflege e.V.: 1-16.

# MONITORING TRANSPORT OF ACRYLATE CONSOLIDANTS THROUGH WOOD BY NEUTRON RADIOGRAPHY

Irena Kučerová<sup>1</sup>, Burkhard Schillinger<sup>2</sup>, Elbio Calzada<sup>2</sup>, Eberhard Lehmann<sup>3</sup>

<sup>1</sup> Department of Chemical Technology of Monument Conservation, Institute of Chemical Technology Prague, Czech Republic

<sup>2</sup> Forschungs-Neutronenquelle ZWE FRM-II of Technische Universität München, Germany

<sup>3</sup> Department Spallation Neutron Source, Paul Scherrer Institut, Switzerland  
irena.kucerova@vscht.cz

## Abstract

Efficiency of wood consolidation depends on the amount of a consolidant in wood and uniformness of consolidant distribution throughout wood. Therefore, wood consolidation studies should include investigation by methods that provide information regarding consolidant solution flow through wood and its distribution. Among such methods there belongs neutron radiography. The present contribution describes suitable measuring conditions at the neutron radiography facility of Technical University of Munich and discusses the potential of the method based on the results obtained with the penetration of solutions of Paraloid B72 polymer in xylene through wood.

## 1. Introduction

The effect of wood consolidation is the better the higher is the amount of consolidant in the wood and the more uniformly it is distributed throughout the wood material [1-4]. This implies that a good penetration of the consolidant (i.e. polymer) solution into the wood structure is imperative to achieve a good consolidation effect. Liquid flow through wood can be described by Darcy's law: [1,5]

$$Q = \frac{KA}{\eta L} \Delta P \quad (1)$$

where:

Q is the liquid flow rate [ $\text{m}^3 \cdot \text{s}^{-1}$ ],

K is the wood permeability factor [ $\text{m}^2$ ],

L is the length of a sample in the flow direction [m],

A is the cross-sectional area to flow [ $\text{m}^2$ ],

$\eta$  is the dynamic viscosity of the liquid [Pa.s],

$\Delta P$  is the pressure difference at the two ends of the sample [Pa].

Although only valid in ideal flow conditions (e.g. homogeneous porous material, no interactions between the liquid and porous material, wood permeability independent of its length in the flow direction), Darcy's law characterizes well the parameters that affect penetration of liquids through wood:

- Wood permeability depends on the anatomical structure of the particular wood species, location of the particular piece of wood in the trunk, flow direction (geometry of the wood piece), wood moisture content, and degree of wood damage. [2,3]
- The pressure gradient driving the process of liquid penetration into the porous wood system emerges as a result of capillary or external pressure (elevated or reduced pressure) thus characterizing the technological process of impregnation. [2,3,5,6]
- Physico-chemical properties of consolidant solutions: Viscosity of the consolidant (polymer) solution depends on polymer relative molecular weight as well as on the type of the used solvent. Where wood impregnation is driven by capillary pressure (capillary action), as is the case when wood is impregnated by coating, spraying, or immersing at the atmospheric pressure, liquid penetration into wood also depends on the liquid's surface tension and adhesion to the capillary walls (when wetting wood surface). Consolidant polarity also plays its role. [1-3,7,8]

The penetrating ability of a consolidant solution increases with decreasing viscosity. This viscosity reduction can be achieved:

- By decreasing consolidant concentration in the solution. There exists, however, a limit under which the amount of consolidant is too low to be effective.
- By selecting a suitable solvent. In fact, viscosity is affected by the affinity of the polymer for the solvent. Polymer solution viscosity increases with increasing volume (bulk) of its macromolecule. A solution whose solvent possesses a solubility parameter approaching that of the polymer (“thermodynamically good solvents”) exhibits a higher viscosity than a solution whose solvent possesses a solubility parameter markedly different from that of the polymer (“thermodynamically poor solvents”). In a thermodynamically good solvent the macromolecule is deconvoluted to achieve a very good contact with the solvent. In this way its volume (bulk) increases, and so does its viscosity. In a thermodynamically poor solvent the macromolecule is convoluted to the highest degree possible, interactions within the macromolecule predominate over solute-solvent interactions, and solution viscosity is lower.
- By reducing molecular weight of the consolidant. There exists, however, a limit for the molecular weight under which the wood consolidation process ceases to be effective.

Hence, an optimum combination of consolidant molecular weight, solution concentration, and type of solvent must be sought if the optimum result is to be obtained as regards solution penetration into wood.

The effect of wood consolidation is evaluated based on consolidant content in the wood, changes in the mechanical properties of the wood, wood resistance to dimensional changes, and other parameters [7-9]. Consolidant distribution through the wood structure is examined by microscopy (fluorescence microscopy, electron microscopy) [4,10-13] and spectroscopy (Raman spectroscopy, infrared spectroscopy) [11,14,15]. Neutron radiography can be used to monitor consolidant solution penetration through wood in real time [15,16].

The presented paper describes the use of neutron radiography for the monitoring of the penetration of solvents and acrylate solutions into wood.

## 2. Experimental part

The flow of liquids through wood was examined on sound lime and fir wood samples 20mm × 20mm × 60mm in size in the radial, tangential, and longitudinal directions. The samples were placed in an aluminium dish. The maximum liquid level height from the sample bottom was 10 mm. Liquid penetration into the wood was driven by capillary action and was examined in the longitudinal direction for 60 minutes.

Acrylate solution penetration into the wood was monitored by neutron radiography at the Antares facility, Technical University of Munich, Germany. The experiments were performed in two separate stages, differing in the facility parameter settings (collimation ratio L/D 400 and 800, sample distance from the scintillator etc.) and in the procedure of liquid addition to the samples.

During Stage 1, wood samples in the low aluminium dish were positioned between the scintillator and collimator, a predetermined volume of the liquid was added, and the measuring facility was turned on. The time between the liquid addition to the dish and the first record was approximately 120s. Based on the evaluation of Stage 1, the experimental conditions were modified for Stage 2. An aluminium vessel with a fitted lid was manufactured and placed to the measuring position. Wood samples on the aluminium dish were placed into the vessel and the liquid was added to the dish after initializing the measuring facility. In this setup the first record could be taken virtually simultaneously with the first contact of the liquid with the bottom surface of the sample, owing to which the penetration process could be monitored from the first minute and possibly the liquid could be replenished during the measurement. A reduction in solvent evaporation was a favourable side effect of the use of the closed vessel accommodating the sample with the liquid.

The resulting images were obtained by division of impregnated samples by non-impregnated ones. The measured data were processed in Microsoft Excel because of calculation the attenuation coefficient based on the exponential attenuation law. The table of values of the attenuation coefficients correspond to planar numerical expression (tangential × axial direction) of relative liquid amount in the sample in the

defined time. The planar information was averaged in the tangential direction of the sample to get one-dimensional illustration of relative liquid amount in the wood sample.

Due to the modifications in the experimental setup, the results obtained during the both experimental stages are difficult to compare. It was found that the solvent and acrylate solution flow through wood can be best visualized by neutron radiography if the following parameters are set: Collimation ratio L/D 400, sample axis-to-scintillator distance approximately 10cm. Andor camera 2kx2k served as the detector: lens 85mm, field of view 124mm × 124mm, exposure time was 8s per frame. Below there are presented only those results of visualization of Paraloid B72 (copolymer of ethyl methacrylate-ethyl acrylate, producer Rohm and Haas Company) solution flow through wood that were obtained using the closed vessel arrangement and the above parameter settings. Toluene, xylene, and ethanol served as solvents, acrylates as consolidants. The acrylate solution concentrations (by weight) were 10%, 15%, 20%, 25% and 30%.

### 3. Results and discussion

Neutron radiography is a non-destructive image method which allows studying solvents and polymer solutions flow through wood in real time. Differences are apparent in the permeability of the different types of wood, in the permeability of different samples of one type of wood, and even in the permeability within a single sample. Therefore, series of samples should always be used for measuring and, where appropriate, the results should be interpreted taking into account results of other types of measurement (such as gravimetric monitoring of liquid absorption by the wood).

Figure 1 shows visualization of the flow of a 15% xylene solution of Paraloid B72. There is virtually no penetration of the solution into the fir wood sample (see Fig.1(h)); in fact, the solution only creeps over the sample surface. In this respect this fir wood sample behaves differently from the samples whose results are shown in Figures 2 and 3. As follows from a gravimetric determination of the uptake of Paraloid B72 solutions (10%, 15%, and 25% by weight) by the wood (see Fig. 2), the uptake of the solutions is roughly identical although the penetration is different. The gravimetric method, however, fails to provide information regarding the liquid distribution throughout the wood. Figure 3 shows that the 20% Paraloid solution in xylene penetrates into fir wood, although due to its higher concentration, its penetrating ability is poorer than that of the 15% solution. As regards lime wood, the liquid front travel through the sample and accumulation beneath the upper surface of a transverse section can be observed in Figure 1. From this site the solvent evaporates. This visualization enables us to monitor the liquid flow through the wood and differences in the liquid concentration within a sample. However, it does not enable us to quantify the concentration profile of the liquid or determine the concentration profile of the Paraloid B72 solution. Since the flow of liquids through wood is a phenomenon similar to the flow of liquids through chromatographic columns, it is clear that the polymer and the solvent will travel through wood at different speeds.

The penetrating abilities of the xylene solutions of Paraloid B72 in comparison to pure xylene are shown in Figure 3. As mentioned above, penetrating ability of solutions decreases with increasing concentration of solute, which can be observed well on the samples of lime wood owing to its anatomical structure. If wood exhibiting a lower permeability to liquids, such as fir wood, is impregnated, the effect of its permeability to liquids plays a more pronounced role as compared to the penetrating ability of the liquid. Unlike polymer solutions, solvents penetrate into wood rapidly. In the case of lime wood, the solvents travel the whole height of the sample in the longitudinal direction practically within one minute.

Quantification of the flow of the 15% Paraloid B72 solution in xylene through lime wood is shown in Figure 4. The quantification patterns illustrate well the liquid front travel through the wood as well as the increasing amount of the liquid. The x-axis basically corresponds to the sample height (6cm), the sample foot lying in the point of intersection of the x and y axes (x-axis value about 1012). Hence, the liquid travels from left to right. The bottom part of the sample (x-axis values roughly 1012-950) exhibits a high attenuation factor, which is in accordance with the high amount of liquid in the sample. This is due to the fact that this part of the sample was submerged in the solution. The attenuation factor decreases appreciably above the solution level. The slow increase in the amount of solution in the lime wood can be observed in the preset time intervals. In a time as short as 1 minute, the front of the 15% Paraloid solution in xylene reached roughly one-half of the sample height (about 3cm in the longitudinal direction) and in 2 minutes it reached two-thirds of the sample height. The quantification

performed also clearly demonstrates accumulation of the liquid beneath the upper surface of the transverse section through the sample. It should be noted, however, that the quantification is not absolutely correct because the effect of neutron scattering by the wood is disregarded. Therefore, procedures to refine the quantification of the flow of liquids through wood should be applied in subsequent investigations. Recently, Paul Scherrer Institute developed software (QNI 1.0) providing correction for neutron radiation scattering by sample. The QNI software eliminates deviations from the first exponential law and allows obtaining exact results which can be used for the right interpretation of polymer solution behaviour during its flow through the wood. A correct quantification will then enable us to monitor the liquid (or polymer) concentration across the entire area of the sample imaged, which neither microscopy nor spectroscopy does.

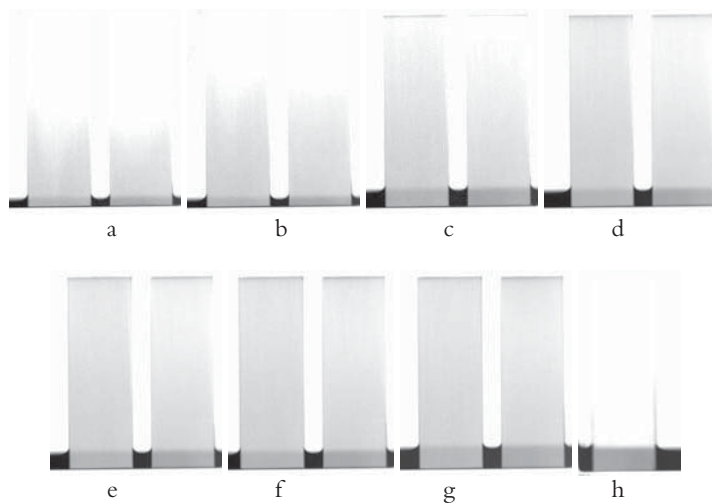

Fig. 1. Flow visualisation of 15% xylene solution of Paraloid B72 through wood in longitudinal direction. (a-g) penetration in lime wood: (a) 1<sup>st</sup>min, (b) 2<sup>nd</sup>min, (c) 5<sup>th</sup>min, (d) 10<sup>th</sup>min, (e) 15<sup>th</sup>min, (f) 30<sup>th</sup>min (g) 60<sup>th</sup>min; (h) 60<sup>th</sup>min of penetration in fir wood.

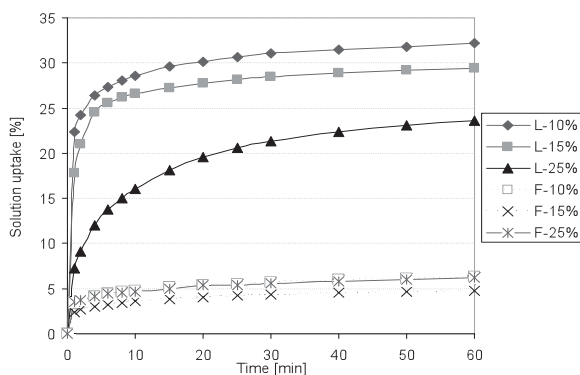

Fig. 2. Uptake of Paraloid B72 solutions in xylene by lime (L) and fir (F) wood, solution concentrations are given in the legend.



## MONITORING TRANSPORT OF ACRYLATE CONSOLIDANTS

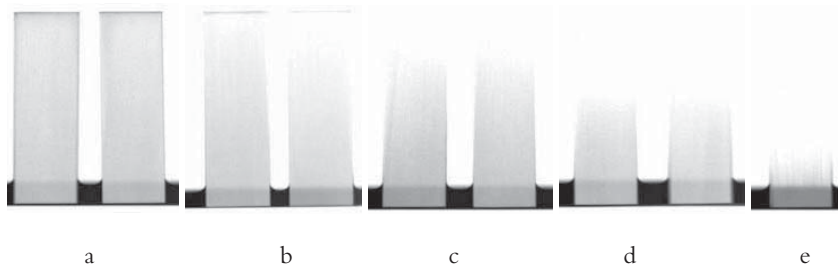

Fig. 3. Visualisation of xylene and Paraloid B72 solutions in xylene penetration, time of capillary elevation is approx. 5min: (a) pure xylene in lime wood, (b) 15% solution in lime wood, (c) 20% solution in lime wood, (d) 25% solution in lime wood, (e) 20% solution in fir wood.

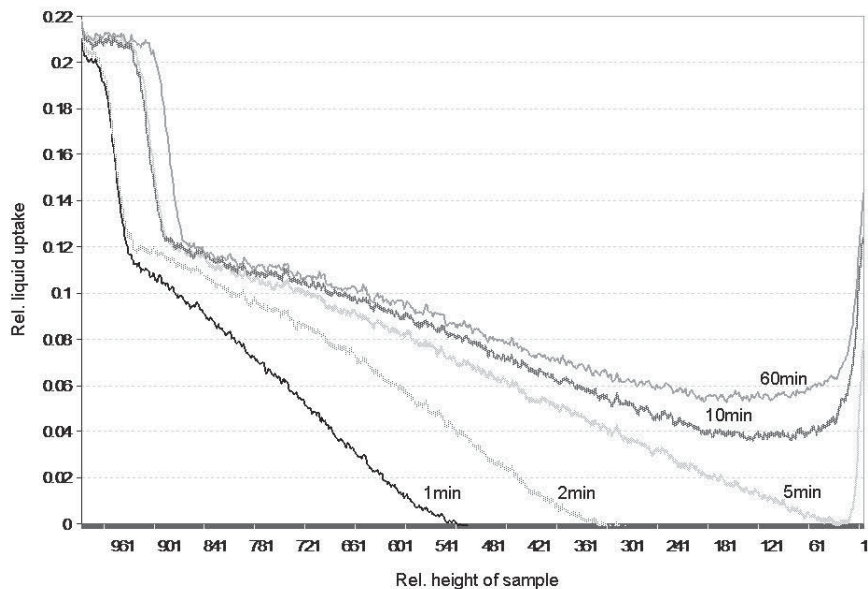

Fig. 4. Quantification of the flow of the 15% Paraloid B72 solution in xylene through lime wood. The x-axis basically corresponds to the sample height, the sample foot lying in the point of intersection of the x and y axes, the liquid travels from left to right, time of penetration is given in the graph.

### 4. Conclusion

The results give evidence that neutron radiography is a suitable technique for investigations into the flow of solvents and polymer solutions through wood. However, accurate quantification of the flow of liquids through wood is an issue that will have to be addressed in the subsequent stages of this research. Quantification as performed so far is not accurate enough because the exponential law of beam attenuation is only valid in first order.

### Acknowledgements

This research project has been supported by European Commission under the 6<sup>th</sup> Framework Programme through the Key Action: Strengthening the European Research Area, Research Infrastructures. Contract no.: RII3-CT-2003-505925

## References

1. Wang Y., Schniewind A.P. (1985): Consolidation of deteriorated wood with soluble resins. *Journal of the American Institute for Conservation*, 24: 77-91.
2. Robertsen L., Lönnberg B. (1991): Diffusion in Wood. *Paper and Timber*, 73: 532-535.
3. Reinprecht L. (1994): "Ochrana dřeva a kompozitov". *Technická univerzita vo Zvolene*.
4. Schniewind A.P., Eastman P.Y. (1994): Consolidant distribution in deteriorated wood Treated with soluble resins. *Journal of the American Institute for Conservation*, 33(3): 247-255.
5. Siau J. F. (1984): "Transport Processes in Wood". Springer-Verlag.
6. Flynn K. A. (1995): A Review of the Permeability, Fluid Flow, and Anatomy of Spruce. *Wood and Fibre Science*, 27: 278-284.
7. Šimůnková E., Josef J. (1988): Petrifikace dřeva v závislosti na polaritě použitých rozpouštědel. I. Obsah petrifikačních látek ve dřevě a rozměrové změny dřeva. *Památky a příroda*, 13(5): 283-285.
8. Šimůnková E., Josef J. (1989): Petrifikace dřeva v závislosti na polaritě použitých rozpouštědel. II. Odolnost proti změnám vlhkosti a mechanická pevnost. *Památky a příroda*, 14(1): 27-29.
9. Šimůnková E., Zelinger J. (1983): Rozměrová stabilita dřeva zpevněného polymery. In "Sborník VŠCHT v Praze S10", VŠCHT Praha, Praha.
10. White M.S. (1977): Influence of Resin Penetration on the Fracture Toughness of Wood Adhesive Bonds. *Wood Science*, 10(1): 6-14.
11. Jensen E.S., Gatenholm P., Sellitti C. (1992): An ATR-FTIR Study on Penetration of Resins in Wood. *Die Angewandte Macromolekulare Chemie* 200: 77-92.
12. Johnson S.E., Kamke F. A. (1992): Quantitative Analysis of Gross Adhesive Penetration in Wood Using Fluorescence Microscopy. *Journal Adhesion*, 40: 47-61.
13. de Majjer M., Thurich K., Militz H. (1998): Comparative Study on Penetration Characteristics of Modern Wood Coating. *Wood Science and Technology* 32: 347-365.
14. Ohlidalová M., Kučerová I., Novotná M. (2006): Identification of Acrylic Consolidants in Wood by Raman Spectroscopy. *Journal of Raman Spectroscopy* 37(10): 1179-1185.
15. Kučerová I., Lehmann E., Ohlidalová O., Novotná M. (2007): Observing penetration of acrylic solutions into wood with neutron radiography and Raman spectroscopy. In "Conservation Science 2007" – in press.
16. Lehman E., Hartmann S., Wyer P. (2005): Neutron radiography as visualization and quantification method for conservation measures of wood firmness enhancement. *Nuclear Instruments and Methods in Physics Research A*, 542: 87-94.

# VARIOUS PHYSICAL AND ANALYTICAL METHODS TO CONTROL THE IMPREGNATION EFFICIENCY OF ARCHAEOLOGICAL ARTEFACTS BY DIFFERENT CONSOLIDATING RESINS

*Khôi Tran*

ARC-Nucléart Conservation Laboratory  
CEA-Grenoble, Grenoble, France  
quoc-khoi.tran@cea.fr

## **Abstract**

The worldwide implemented process for the conservation of wet archaeological objects is the water-soluble polyethylene glycol (PEG) impregnation of the object, followed by controlled air-drying or freeze-drying. The dimensional stabilisation and the consolidation of the wood depend on the degree of diffusion of the polyethylene glycol within the wood. It is thus necessary to control the amount of PEG inside the artefact, in order to conserve it the most efficiently. Many analytical methods can be used for PEG detection in wood, such as FTIR, Mass Spectrometry and Liquid Chromatography. The last results from solid Nuclear Magnetic Resonance spectrometry will be presented. X-ray Radiography and X-ray Scanner are useful tools to control the consolidation efficiency of degraded artefacts by resin or polymers. The application of these non-destructive techniques will be described for the treatment of composite wood-metal artefact by hydrophobic resins.1.

## **1. Introduction**

Wet wooden archaeological artefacts are worldwide conserved by polyethylene glycol impregnation, followed by their drying by freeze-drying or controlled air-drying. The degree of diffusion of PEG within the wooden structure is important for its dimensional stabilisation and structural consolidation. In order to diagnose the efficiency of the conservation treatment, the method used is the determination of PEG content in the wood, and the state of the art in this analysis is firstly, the most current extraction of PEG from wood samples by the “*Soxhlet*” process, and secondly, the spectroscopic quantitative analysis based on FTIR and NMR (most recent). For composite artefacts (wood–metal association) or sulphur containing artefacts, one of the most effective treatments consisted to impregnate totally the wood porosity by an hydrophobic resin such as rosin or colophony (natural resin) or a radiation-curing polyester resin, this last one being implemented at ARC-Nucléart laboratory in Grenoble, France. Due to the fact that the crosslinked polyester resin is no more soluble in any solvent, i.e extraction impossible to realise, X-ray radiography of treated artefacts is the method used to control the degree of resin impregnation inside the wood structure. This paper will describe the protocol for the PEG quantification by extraction, the results from our Danish colleagues on treated Viking ships, comparing the extraction method and the FTIR one, as well as our last results by solid state NMR spectroscopy. It will show also our recent results on the use of radiography on radiation-curing resin treated objects.

## **2. Diagnosing the efficiency of PEG treatment**

### **2.1 Quantification of PEG in wood by extraction and FTIR**



Fig. 1. Drilling in the wood timber and the obtained core sampling.

*A. The case study at ARC-Nucléart* laboratory presents the control of PEG 4000 impregnation in an oak timber from a 14<sup>th</sup> century wine press structure excavated from Bordeaux. With 3 meter

long and 30 cm thickness, the artefact is degraded on the surface layer of about 5 cm thickness, while the wooden core is little degraded. It was impregnated in a 35 % PEG 4000 during almost 2 years (December 2005 to August 2007) and the picture shows the drilling in the timber by a conservator to extract a core sample (on the right) of 15 cm long.

After drying out, the core sampling is separated in 2 parts (near the surface, and inside) for PEG extraction by *Soxhlet* (extraction apparatus by solvent reflux through the sample) using tetrahydrofuran as solvent. The PEG concentrations in the extracted solutions are finally analysed by liquid chromatography.

#### **Results**

In the surface layer, the PEG content in the wood is around 30 %, while this content decreases to less than 5 % in the core. This means that little degraded oak is very difficult to impregnate due to its anatomy, a well known feature, and it is not worth to increase the impregnation duration. This diagnosis permits to adopt a new strategy of conservation : i.e freeze-drying of the timber at this impregnation rate, instead of the initial one consisting of quasi full 80 % PEG impregnation followed by air-drying.

#### ***B. Impregnation depth of PEG in Wood from the Roskilde Ships, Denmark***

This study of Anna Katarina Tjelliden and al.[1] from *The School of Conservation, The Royal Danish Academy of Fine Arts*, is an evaluation of the conservation process of three oak wood ship objects from Roskilde Wrecks 2 (16,5 m long, 4,5 m wide, dated 1185 AD) and 4 (20,5 m long, dated 1100 AD), excavated in 1996-97. This is done by examining the state of deterioration, depth of impregnation and amount of PEG 2000 in the wood. Three samples were taken from wooden ship parts in the PEG/water impregnation bath (20% and 32% PEG 2000) and from freeze dried wood (32% PEG 2000) respectively. The approximate amount of PEG was estimated by extraction and by ATR FT-IR analysis. PEG distribution, impregnation depth and molecular size were examined by MALDI-TOF MS. The examination showed that the amount of PEG was greatest in the first 6-12 mm of the wood but MALDI-TOF analysis showed PEG 2000 up until 40-50 mm in to the wood. PEG 2000 is regarded as efficient to conserve the waterlogged oak wood as its molecular size is large enough to stabilize the surface cell wall material and at the same time small enough to bulk the hygroscopic groups deeper in the wood. This is furthermore proved by SEM pictures of the impregnated cell walls.

#### **Results**

##### ***ATR FT-IR***

An accurate calculation of the PEG amount of the wood discs is not possible using ATR FT-IR. One might instead quantify the amount of PEG in relation to the wood amount. To do this one has to locate a peak which as far as possible resembles wood without any contribution from the PEG 2000. In this project a peak at approx.  $1028\text{ cm}^{-1}$  is used as characteristic for the "wood peak". This signal originates most likely from C-O stretch vibrations in holocellulose.

By comparing spectres from pure PEG 2000 with spectres from unimpregnated archaeological wood, one can see where the spectres differ from one another and thereby locate a "PEG peak" which almost has no contribution from the wood signal. It seemed that there was such a peak at  $841\text{ cm}^{-1}$ . FT-IR analysis was taken of all the wood samples upper surface (facing the surface of the artefact) and a characteristic result of this is shown in figure 2.

##### ***Soxhlet Extractions***

The extraction of PEG 2000 by *Soxhlet* extraction gave information about the PEG amount within the wood.

The three ship timbers are in the difficult state of preservation in relation to conservation matters. They are heterogeneously deteriorated with a heavily deteriorated surface and a well preserved core. Examinations of the wood showed that the freeze dried wood from Wreck 4 is the most deteriorated in the surface having a density of  $0,12\text{ g/cm}^3$ . Further in the wood it had densities about  $0,62\text{ g/cm}^3$ . The 32% impregnated wood from Wreck 4 is least deteriorated (density of  $0,46\text{ g/cm}^3$ ). Further in the wood it had densities of  $0,56\text{ g/cm}^3$ . The 20% impregnated wood from Wreck 2 had a density of  $0,34\text{ g/cm}^3$  in the outer layer meanwhile in the core it had densities about  $0,51\text{ g/cm}^3$ .

Figure 3 and 4 show the PEG amounts of the two wet samples from Wreck 2 and 4. The results from the freeze dried sample are shown in Figure 5.

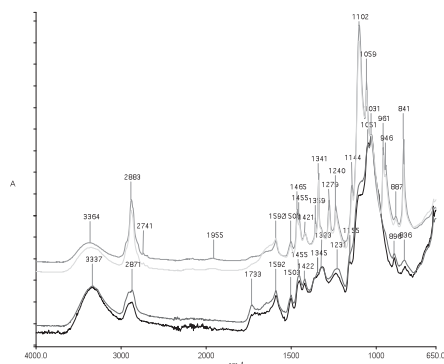

Fig. 2. The relative amount of PEG is calculated by the peak at  $841\text{ cm}^{-1}$  (PEG) in relation to the peak at  $1031\text{ cm}^{-1}$  (wood). The upper surface of the four outer discs of the 32% impregnated sample shows that the PEG amount is high at the surface (two top spectres) until approx. 6 mm into the wood. By a closer look on the peak at  $841\text{ cm}^{-1}$ , one can see a drop of the PEG amount in the last two discs (12 and 17 mm from the surface of the wood). The spectres are normalized by  $1031\text{ cm}^{-1}$ .

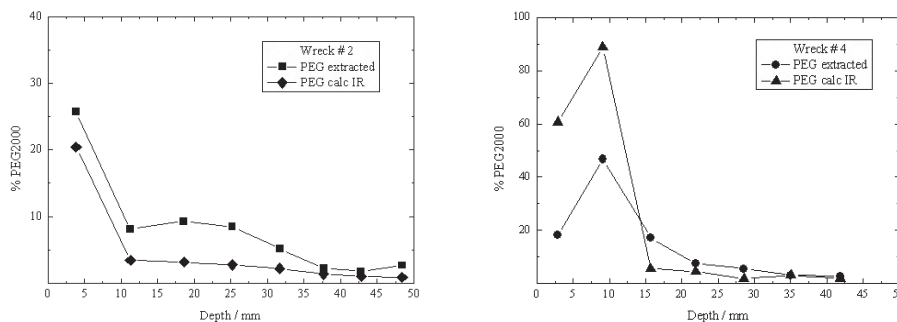

Fig. 3 (left): Results from examinations of the 20% impregnated wood (Wreck #2); PEG amount as function of depth in the wood. The depth (mm) is measured from the centre of each disc. The ■ lines are PEG amounts; the weight loss (%) of the disc after extraction. The ◆ lines are the results from FT-IR measurements of the PEG peak ( $841\text{ cm}^{-1}$ ) in relation to the wood peak ( $1028\text{ cm}^{-1}$ ).

Fig. 4 (right): Results from examination of the 32% impregnated wood (Wreck #4); PEG amount as function of depth in the wood. The depth (mm) is measured from the centre of each disc. The ● lines are PEG amounts; the weight loss (%) of the disc after extraction. The ▲ lines are the results from FT-IR measurements of the PEG peak ( $841\text{ cm}^{-1}$ ) in relation to the wood peak ( $1028\text{ cm}^{-1}$ ).

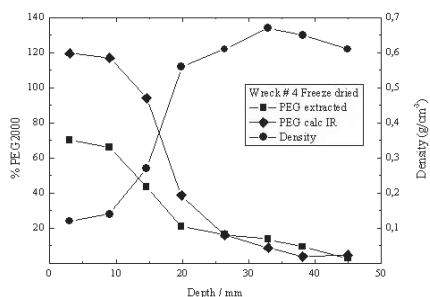

Fig. 5. Results from examinations of the freeze dried sample; PEG amount and depth as function of depth in the wood. The depth (mm) is measured from the centre of each disc. The ■ line is PEG amount; the weight loss (%) of the disc after extraction. The ● line is the density of the wood ( $\text{g}/\text{cm}^3$ ). The ◆ line is the results from FT-IR measurements of the PEG peak ( $841\text{ cm}^{-1}$ ) in relation to the wood peak ( $1028\text{ cm}^{-1}$ ).

The PEG percentage drops drastically when the density of the wood rises. The structure of the wood and the state of preservation are indeed regulating the depth of impregnation. The connection between density and the PEG amount is shown in Figure 5 where the results from the PEG extractions and FT-IR analyses are shown together with the density of the wood. The marked change happens at 12 mm when the wood becomes more solid and the PEG amount hence drops.

The examination of the three ship parts from the Roskilde Ships Wreck 2 and 4 proved that using a water solution of 35-40% PEG2000 stabilizes the surface of the wood (6 mm) meanwhile bulking the hydrophilic cell walls further in the wood. The conservation process is therefore an effective method for conserving the waterlogged heterogeneously deteriorated oak wood.

## 2.2 PEG quantification in wood by $^{13}\text{C}$ high-resolution solid-state Nuclear Magnetic Resonance (NMR)

$^{13}\text{C}$  high-resolution solid-state Nuclear Magnetic Resonance (NMR) was used to characterize the structural features and the degradation of archaeological waterlogged artifacts made of wood or leather, since each NMR signal holds relevant information on the chemical structure surrounding the corresponding carbons. The characterization of these materials can easily be carried out before and after their conservation treatment by polyethylene glycol (PEG) impregnation [2].

Another fundamental aspect of solid-state NMR is the possibility to study the molecular dynamics of materials. Indeed, through the measurements of different relaxation times and exchange rates classically obtained with NMR, one can get insights in the molecular motions appearing in the time scale of the NMR experiment, which ranges from less than 1 Hz to more than 10 MHz. All NMR experiments were carried out on a BRUKER DSX 200 spectrometer operating at 50.3 MHz for the  $^{13}\text{C}$ . For the analysis of the data, the signal processing software DIMFIT was used for signal deconvolution and integration when needed.  $T_{1\rho\text{H}}$  and  $T_{\text{CH}}$  time constants were obtained by fitting experimental cross-polarization build-up curves using origin.

## 3. Results and discussion

A starting point for the qualitative analysis of archaeological wood samples can be found in Figure 6 where the  $^{13}\text{C}$  NMR spectra of as-found archaeological and modern woods, spectrum A and B respectively, are compared. Spectral regions that are representative of the different wood components -celluloses, hemicelluloses and lignins- are indicated.

Spectra C and D, corresponding, respectively, to non-treated and PEG 4000-treated archaeological wood samples from Charavines' excavation, are shown in Figure 7. From the spectra C, D and E, it clearly appears that the signal assigned to PEG strongly overlaps with cellulose resonances. Therefore, the measurement of each signal integral is almost impossible, preventing any quantitative analysis. This problem has been solved using a deconvolution software dedicated to NMR spectra. The strategy is illustrated in Figure 8. First a complete spectral decomposition is carried out on the non-treated sample as shown with the spectra on the left of Figure 8. The different signals assigned to wood components are calculated, and their signal properties such as isotropic chemical shift, line shape, line width at half height, and relative integrated intensities, are further used as a starting point for the deconvolution of the PEG-treated wood spectra, as shown on the right-hand side of Figure 8. With this protocol, the intensities and integrals of the PEG signal were easily measured for samples impregnated by aqueous PEG solutions of increasing concentration. The result is given in Figure 9. It clearly appears that the PEG amount measured inside the wood samples increases regularly with the concentration of the PEG-solution to reach a plateau for a 35 % PEG solution. It is, to our knowledge, the first quantification of PEG impregnated inside treated archaeological-wood samples, without any time-consuming chemical extraction and quantification. From this study, we can conclude that it is not necessary to use solution with concentrations in PEG higher than 40% for the conservation of archaeological wood objects of this state of degradation using PEG 4000. This kind of analyses can undoubtedly allow an optimization of the conservation processes.

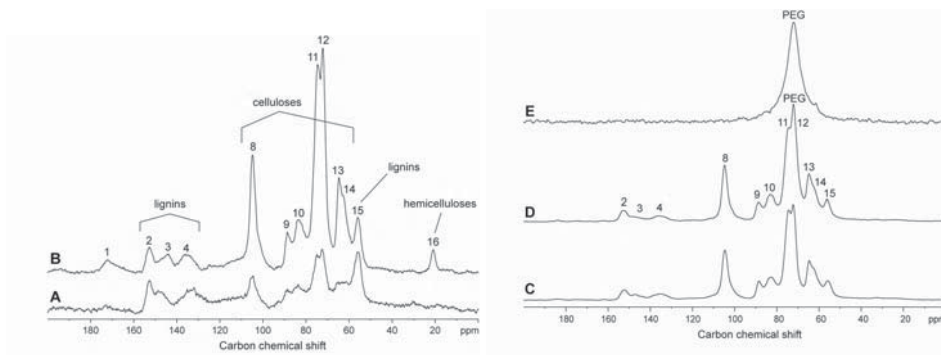

Fig. 6 (left). 50 MHz  $^{13}\text{C}$  CP-MAS high-resolution solid-state NMR spectra of as-found archaeological wood (10<sup>th</sup> century) from the Portuguese dugout canoe, Mazarefe (A), and modern wood from beech (B)

Fig. 7 (right). 50 MHz  $^{13}\text{C}$  CP-MAS high-resolution solid-state NMR spectra of oak archaeological samples from the 11<sup>th</sup> century excavation site in the lake Paladru at Charavines, France (C-D) and pure commercial PEG 4000 sample (E). (C) is the spectrum of as-found archaeological wood and (D) of the same archaeological wood impregnated with a PEG 4000 aqueous solution (weight concentration of 50 %).

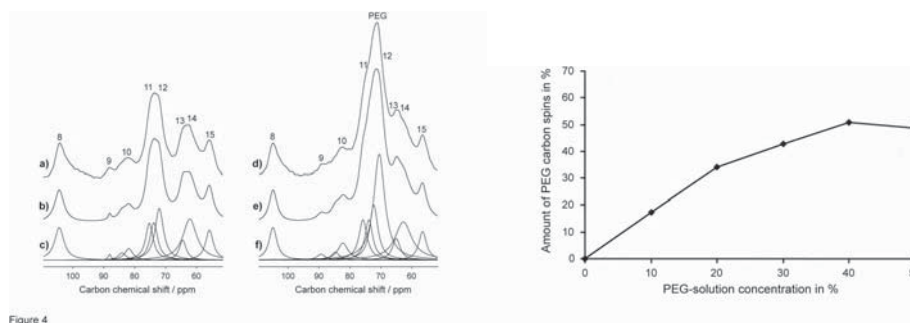

Figure 4

Fig. 8 (left). Decomposition of the NMR spectral region assigned to cellulose for as-found (left spectra) and PEG 4000-treated (right spectra) archaeological wood. a) and d) correspond to experimental spectra recorded with direct  $^{13}\text{C}$  excitation under magic angle spinning. The individual calculated signals found by the deconvolution are given in c) and f). The simulated spectra based on the deconvolution are given in b) and e).

Fig. 9 (right). PEG content (in % of total carbon content) as a function of the concentration of PEG 4000 aqueous solutions used to impregnate the archaeological woods.

#### 4. Diagnosing the total bulking of the wood porosity by X-ray radiography

This non-destructive testing (X-ray of 50 kV) was implemented last year at ARC-Nucléart to control the efficiency of the radiation-curing resin treatment for archaeological artifacts containing corroded metals and/or unstable sulphur compounds such as elemental sulphur S8 or iron disulphide, pyrite [3].

The samples are fragments from the Roman period boats excavated in Toulon, France, and treated by PEG/freeze-drying ten years ago. Mineral efflorescences are still developing on some artifacts containing corroded nails, and the aim of the radiation-curing treatment is to stabilize the overall object by filling up the residual porosity of the wood and by embedding the minerals in the same resin. The process consisted to impregnate these artifacts in a tank under vacuum/pressure by a liquid styrene-unsaturated polyester resin, then to polymerize the resin *in-situ* by irradiating the impregnated wood with gamma rays. Sealed sources of cobalt 60 are emitters of gamma rays, and the treatment needs 24 to 48 hours of irradiation, totaling an absorbed dose in the range of 30-40 kilograys.

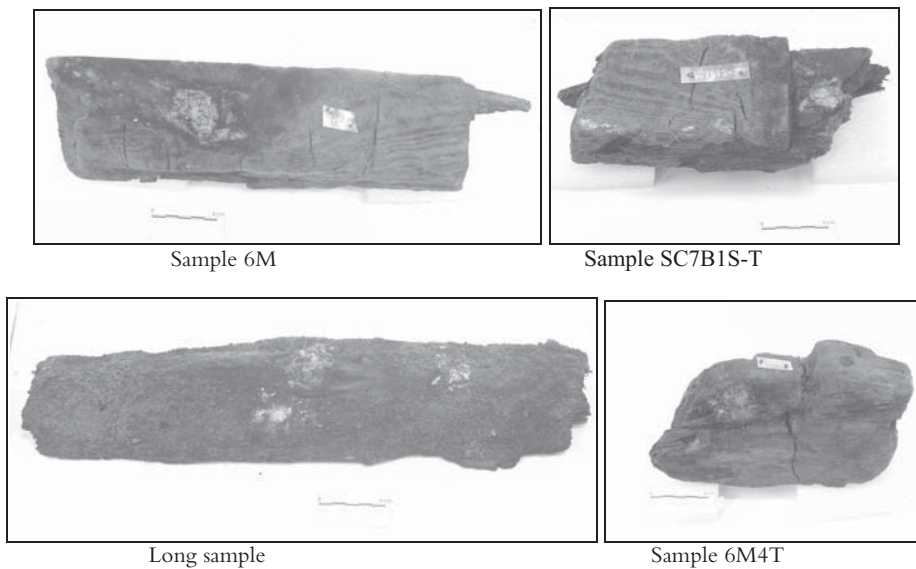

Fig. 10. Fragments presenting mineral efflorescence after PEG/freeze-drying treatment.

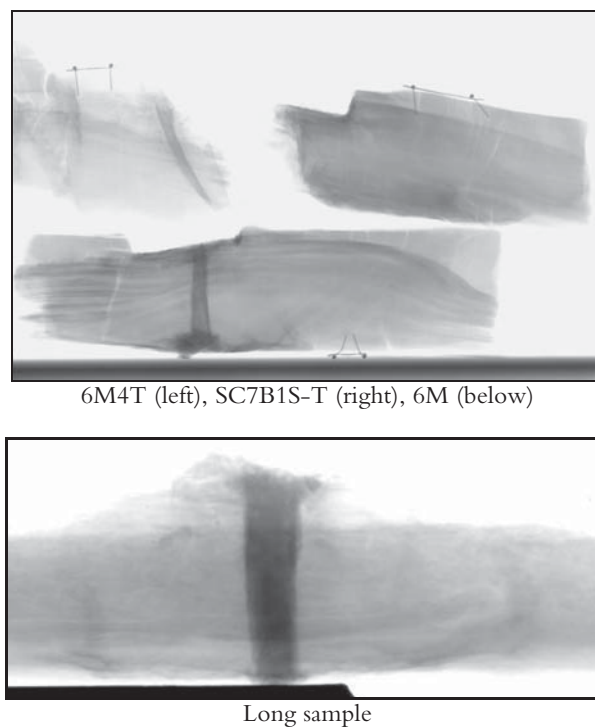

Fig. 11. X-ray Radiography before radiation-curing resin treatment.



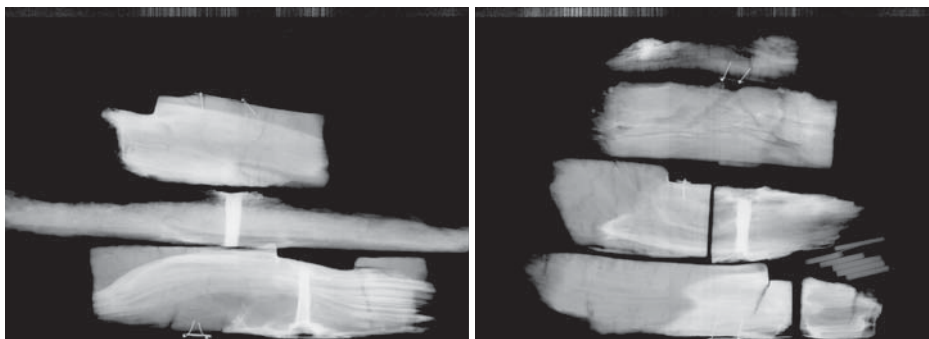

Fig. 12. X-ray radiography after radiation-curing resin impregnation

The clear parts on the 3 pictures on the left correspond to the nails (long sample and sample 6M) and the repartition of the resin within the object structure. It is shown that some areas, mainly on the surfaces, are not totally impregnated by the resin.

#### 4. Conclusion

The efficiency of PEG treatment for archaeological artefacts is based so far on the PEG extraction from wood samples in order to determine its content in the wood. In many cases, it was shown that the PEG macromolecules in the range of 2000–4000 had difficulties to diffuse into the core of the object, due to several factors such as the wood anatomy and its degree of deterioration. Recent researches try to avoid the extraction phase, and analysing directly the PEG in the wood sample. Promising results were obtained with FTIR and NMR spectroscopy. Our future objective is to validate the FTIR method via its correlation with NMR.

It is certain that X-ray radiography is a very useful tool for the treatment diagnostic, especially in the case of full impregnation of the wooden porosity by an organic resin. When it is possible, scanner or computerized tomography can give undoubtedly more precise information about the repartition or localisation of the consolidant from the surface to the core of the object.

#### Acknowledgements

The author is very grateful to Anna Katarina Tjellén from the School of Conservation, the Royal Danish Academy of Fine Arts for her contribution by sending the results of her study.

#### References

1. A.K.Tjellén, K.P. Simonsen and K. B. Botfeldt (2007): An evaluation of the PEG 2000 impregnation process of the Roskilde ships, Denmark. ICOM-Committee for Conservation–Wet Organic Archaeological Materials Working Group Conference, Amsterdam September, in press.
2. M. Bardet, G.Gerbaud, K. Tran and S. Hedinger (2007): Study of interactions between polyethylene glycol and archaeological wood components by C13 high-resolution solid-state CP-MAS NMR. *Journal of Archaeological Science*, 34, 1670–1676
3. K. Tran and M. Guinard (2007): Stabilisation of dry archaeological wood having sulphur compounds by impregnation of radiation-curing unsaturated polyester resin. ICOM-Committee for Conservation–Wet Organic Archaeological Materials Working Group Conference, Amsterdam September, in press.

# EXTERNAL RESISTANCE TO WATER VAPOUR TRANSFER OF VARNISHES ON WOOD

Ottaviano Allegretti<sup>1</sup>, Francesca Raffaelli<sup>2</sup>

<sup>1</sup> CNR-IVALSA, San Michele all'Adige (TN), Italy

<sup>2</sup> Soprintendenza Beni Storico Artistici of Autonomus Province of Trento, Italy  
allegretti@ivalsa.cnr.it

## Abstract

This paper reports results of experimental measurements of diffusive water vapour flux through wood specimens coated with varnishes and resins commonly used in the field of restoration. The internal and the external resistance to the transport of water in wood was calculated with a numerical method from sorption tests. The results show that all painting layers reduce the flux. The calculated mass transfer coefficient is an important physical characteristic of the material and it allows improved models for the understanding and prediction of the influence of coatings and painting layers on the hygroscopic and deformative behavior of wooden objects.

## 1. Introduction

Wood is an hygroscopic material. Its moisture content (MC) at equilibrium (EMC - Equilibrium Moisture Content) is a function of the relative humidity (RH) and temperature (T) of surrounding air. Whenever the hygro-thermal conditions of the environment change, the wood tends to reach a new EMC, adsorbing or desorbing water. Shrinkage and swelling always accompany the variation of MC and they are probably the main source of problems for the conservation of wooden artefacts because they can cause deformations, internal stresses, cracks of the wooden support and degenerative phenomena of the painted layers such as delamination [1].

During the transient phases of sorption (absorption or desorption) in response to a RH change, the water — in the form of bound water and vapour in the cell cavities — diffuses from the region of high moisture concentration to one of lower moisture concentration. The transport rate of water between wood and surrounding air is controlled by two resistances, namely the external resistance due to the boundary layer at the surface and the internal resistance due to the wood structure. For a porous and hygroscopic media such as wood, the internal molecular flow under the influence of a concentration gradient is represented, according to many authors, by Fick's law of diffusion which relates the flux ( $J$ ) to the moisture concentration gradient [2]:

$$J = -D\nabla c \quad (1)$$

where:  $D$  = diffusion coefficient [ $\text{m}^2 \text{sec}^{-1}$ ];  $\nabla c$  = concentration gradient, i.e. the difference of concentration  $c$  between two points separated by a distance  $x$ .

The external transport flux of vapour of the exchange surfaces is defined by:

$$J = S(c_{surf} - c_{ext}) \quad (2)$$

where  $c_{surf}$  is the water concentration of the surface at the equilibrium with air,  $c_{ext}$  is the water concentration of the surrounding air and  $S$  is the surface emission coefficient [ $\text{m sec}^{-1}$ ].

In the case of wood,  $D$  depends on many variables, some of which have been investigated in the past years, mostly in the field of applied research of industrial wood drying. It is known that  $D$  has a positive relationship with T and MC, that it is from 2 to 10 times higher in the longitudinal direction than in the transversal direction and that it is 15% to 25% higher in the radial direction of softwood than in the tangential direction [2]. Significant variability can be observed among wood species where  $D$  lies in the range  $10^{-8}$  to  $10^{-11} \text{ m}^2 \text{ s}^{-1}$  [2, 3].

External resistance depends on the characteristics at the wood-air interface. It is related to air temperature, humidity, speed and the type of flow (turbulent, laminar) as well as with wood surface

characteristics such as roughness, MC and density. Widely variable values of  $S$  are found in the literature. This is due to the large number of methods used to measure and calculate  $S$  and to the great number of variables influencing the results. Sorption tests in a thin lamella at several temperatures give values in the range of  $1\text{--}5 \times 10^{-7} \text{ m s}^{-1}$  [4]. Other methods lead to values in the range of  $5\text{--}20 \times 10^{-6} \text{ m s}^{-1}$  [5].

The presence of paint layers on the surface of a wooden object can increase the resistance at the boundary, influencing the rate of vapour transfer between air and the object, with different consequences on conservation. Paint layers can form a helpful vapour barrier which reduces the influences of environmental climatic variations, above all high frequency fluctuations such as the daily RH variations that affect the superficial zones of the wood. On the other hand, asymmetrical mass transfer in panel paintings due to the different permeability of painted and rear sides can produce cupping deformations in the panel for short periods during transient variations, after a RH change. This phenomenon is well known in the field of restoration and many publications describe practices for the insulation of the rear side of panel paintings using different materials and techniques in the attempt to reduce the effect of asymmetric transfer [6]. However, in this case, good results can be attained only if the permeability properties of the barrier materials are known.

The work described in this paper is in the framework of a larger project aiming to characterise the permeability properties of different families of materials, used in the past for panel paintings and nowadays in the field of restoration. The first results of the permeability of different combinations of painting layers replicated according to techniques and materials used in the period from the late Middle Ages to the Renaissance are going to be published soon in [7]. In this paper, with the same methods, the results of the tests on nine types of varnishes and resins commonly used in the field of the restoration for the consolidation and protection of painting layers and wood of the support are reported and compared with the permeability of painting layers.

The database developed in the project aims to be a tool providing information to the restorers and conservators in the choice and use of the materials and substances. Moreover it aims to improve the efficiency of numerical models for the understanding and prediction of the influence of coatings and painting layers on the hygroscopic and deformative behaviour of wooden objects subjected to changes in environmental climatic conditions.

## 2. Measurement of diffusion coefficient

Cup test (steady-state method) and sorption test (unsteady-state method) are the main experimental methods for the measurement of the mass transfer coefficient. Both methods consist in measuring the diffusive flux produced by vapour concentration difference passing through a known exchange surface in the time interval [3]. In theory the two methods should give the same results; this is quite true at lower moisture content but at higher moisture content the cup method  $D$ -value tends to be about double that the unsteady-state one, because of stress relaxation phenomena involved in the latter case [8, 9]. An experimental comparison between the two methods, performed at the beginning of this work, confirmed the discrepancy between the two methods. Furthermore, in the case of sorption modelling, we are mostly interested in the unsteady-state diffusion coefficient values. and so, for all these reasons, sorption test was preferred.

In the sorption method, the weight change of hygroscopic specimens due to a step change in the external RH is measured from the beginning until the end of the test, when the wood reaches a state of equilibrium (constant weight). The specimens are placed in a climatic chamber and first equilibrated to a given constant climatic condition. When they are equilibrated, the RH in the cell is changed to a new set value. The mass variation of specimens due to sorption of the wood is measured periodically until the specimens reach the new EMC. The gradient (and consequently the flux) is maximum at the beginning and then it decreases, varying during time ( $t$ ) and space ( $x$ ), through the thickness of the specimen. This is an unsteady-state condition described by the Fick's second law. The result of a sorption measurement is a sorption curve, the plot of the weight change versus time.

Sorption tests can be performed at any  $T$  and RH values and in both directions (absorption or desorption). The results have different values and different meaning according to the dependency of  $D$  from  $T$  and local MC of wood and also according to the hygroscopic hysteresis of wood, a phenomenon responsible for the variation of EMC when reached from adsorption or desorption.

The quality of the data from a sorption test mainly depends on the performance of the climatic

chamber. It must ensure very stable climatic conditions over time and uniformity throughout the volume of the chamber. The RH change must be very fast and without any significant variation of T. For this purpose a special dew-point climatic chamber was designed and built [10]. The volume of the chamber is small (0.15 m<sup>3</sup>) suitable for small specimens. The analytical balance is in the interior of the chamber, protected against vibrations and air fluxes. Two holes with rubber baffles permit manipulation of the samples during weighing operations without the need to open the door. The results of sorption tests with the following parameters are reported: T 25° C constant; RH<sub>1</sub> 40%; RH<sub>2</sub> 60% (absorption, EMC from 7.6% to 11.1%); air speed: 0.5 m sec<sup>-1</sup>; time from RH<sub>1</sub> to RH<sub>2</sub> less than 1 minute; weighing every ½ hour during the first day, then with decreasing frequency.

### 3. Samples

Brick shape wooden samples (8 x 150 x 100 mm) were cut from a sound radial sawn board (quarter sawn board) of Spruce (average normal density: 410 kg m<sup>-3</sup>). The faces of the specimens were carefully oriented according to the three anatomical directions in the tree: Longitudinal (L), Radial (R), Tangential (T). Radial sawn boards are the most commonly utilized for panel paintings because they are more stable than tangential sawn boards (flat sawn boards). In Italy, the recurrence of Spruce wood (*Picea abies*) in panel painting and altarpieces is common in the Alpine regions and sporadic in the pictorial Italian Schools of central Italy [11]. Spruce wood was selected because it is more studied than other wood species, with well-known and documented physical and mechanical characteristics, and because it is easy to find defect-free (knots, spiral grain, reaction wood etc.) and it has homogeneous characteristics (density, rings pattern etc.).

Table 2. Name and composition of varnishes and resin used for the series of specimen with varnish only.

ID	name	resin	thinner	layers	company
G MS	<i>Gum mastic</i>		Alcohol	3	<i>Maimeri</i>
G DM	<i>Gum dammar</i>		White spirit	3	<i>Maimeri</i>
B72 3L	<i>Paraloid B72</i>		Acetone 10%	3	
A G V	<i>Artist gloss varnish</i>	Chetonic resin		1	<i>Windsor &amp; Newton</i>
W M T5	<i>White matt "a tableaux"</i>	Gum dammar and beeswax	Turpentine oil	1	<i>Lefranc &amp; Bourgeois</i>
M W V	<i>Mat Watteau varnish</i>	With wax		1	<i>Watteau</i>
RGLRZ	<i>Regalrez 1094</i>	Alyfatic resin	White spirit 35%	1	<i>Eastman</i>
LS O	<i>Linsed Oil</i>			1	
B72 SAT	<i>Paraloid B72</i>		Acetone 10%	Up to the saturation	

One face (in the radial plane) of each sample was coated with the testing coating substances. The opposite face and the remaining four edges were sealed with aluminium sheet and silicon adhesive. In this configuration the flux of vapour occurs in the T direction only, through the coated surface. The surface of wood of the specimens without any preparation were coated with a number of layers (from 1 to 3) of 9 types of varnish or resin (directly on the wood surface). Those substances (listed in table 1) were selected among the different products commonly used in the field of restoration for the consolidation and protection of wood and painting layers. Each coating type was replicated on two series of specimens with different dimensions and coming from different sawn boards. One reference specimen (dummy) for each type was kept uncoated. The combination of nine coating types replicated two times plus nine reference case of uncoated bare wood specimen

led to 27 specimens.

Currently tests on the following substances for consolidation are in progress: *Gelvatol*, *Klucel G.*, *Aquazol 200*, *Aquazol 500*, *Plexisol P550*, *Paraloid B-72*, *Paraloid B-67*, *Primal AC33*, *Akeogard AT 35*, *Akeogard AT 40*, *Plextol B500*. for those tests will be published in the next CESMAR 7 which will be held in Padova (Italy) next October.

#### 4. Calculation

During a diffusion experiment the global mass change of the wooden object is measured and this allows the calculation of the apparent diffusion coefficient  $D^*$  which includes both  $S$  and  $D$ , i.e. the external and the internal resistances.  $D = D^*$  only if the external resistance is zero (high value of  $S$ ). Such an occurrence means that the surface of wood is at an instantaneous equilibrium with the external air conditions.

Different methods can be used to calculate  $D^*$  from a sorption test. The classical way is to calculate  $D^*$  from the slope of the normalized sorption curve (i.e. the fractional weight change  $E$  versus the square root of time) according to eq. 4 representing an analytical solution of Fick's second law:

$$D^* = \frac{\pi x^2}{4} \left( \frac{dE}{d\sqrt{t}} \right)^2 \quad (3)$$

where  $E$  is the normalized weight change  $= \Delta M_t / \Delta M_e$ , and  $\Delta M_t$  and  $\Delta M_e$  are the weight changes at time  $t$  and at final equilibrium respectively, and  $x$  is the thickness of the sample [12]. The slope  $dE/d\sqrt{t}$  is usually calculated in the part of the curve from 0 to  $E=0.5$  corresponding to the half sorption time ( $t_{0.5}$ ).

In thin samples, in correct experimental conditions, a surface resistance different from zero generates a sigmoid trend of the initial part of the normalized sorption curve [13]. It allows to separate  $D$  and  $S$  from  $D^*$ .

In this work a numerical model based on the finite element method (FEM) was used for determining the mass transfer coefficients  $S$  and  $D$  from the shape of the curve. The model was developed on a commercial FEM software package (*COMSOL Multiphysics*®) with a module for transient analysis of the mass balance governed by diffusion. A 1-D geometry is sufficient to represent the unidirectional flux of the experimental conditions. The problem was hence simplified with a line with length  $L = x$  where  $x$  is the thickness of the specimen. The line corresponds to the sub-domain where the internal transfer, controlled by  $D$ , acts. The two ends of the line correspond to the surfaces where the boundary conditions act. According to equation 2, the surface emission coefficient  $S$ , controls the boundary conditions in terms of the rate of change in the zero thickness layer at the surface. A condition of insulation ( $S = 0$ ) was imposed on one end corresponding to the sealed face of the specimen. The coating of the other end was considered just a surface with a zero thickness influencing the value of  $S$ . In order to avoid confusion in the text  $S$  refers to the surface emission coefficient of uncoated wood and  $P$  to the permeability coefficient of coatings on the wood's surface. It should be pointed out that in this condition, the thickness of the coating can influence the  $P$  value. Further details on the model can be found in [7,10]. The coefficients were determined by inverse method, consisting of finding the values of coefficients which produce the best fit between experimental and simulated curves. The  $D$  and  $S$  coefficients were previously determined from experimental sorption curves of uncoated specimens. In particular  $S$  was determined from the shape of the initial part of the sorption curve.  $D$  was considered to be constant in the entire range of variation of MC. This assumption is realistic when the variation is small. The model tuned in  $D$  is then used with the same procedure for the determination of  $P$  from sorption curves of coated samples, by varying  $S$  and assuming that  $D$  remains constant.

#### 5. Results

The normalized sorption curves for all of the specimens are reported in figure 1 (left). The total sorption time needed to reach the equilibrium was quite variable, being about 40 days for uncoated specimens ( $D0\ 0$ ) and over 200 days for some coated specimens Half sorption time ( $t_{0.5}$ ) ranged from about 2 to 23 days. The half sorption time is a measure of the barrier effect of different

materials.

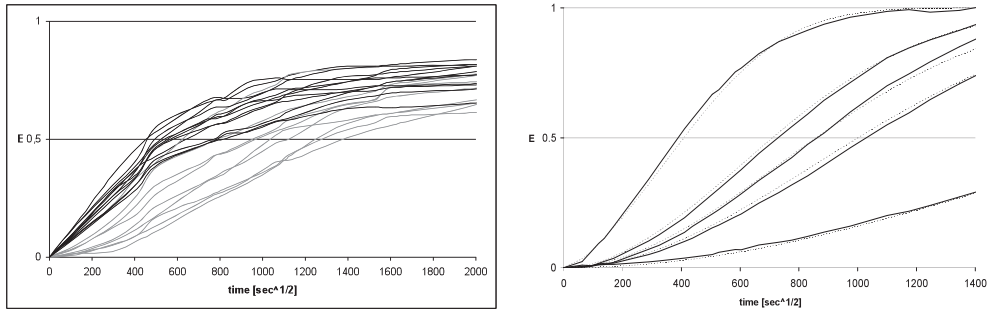

Fig. 1. Right: Normalized sorption curves for all specimens (first period); black lines: reference uncoated specimens; red lines: coated specimens. Left: comparison between experimental data (continuous lines) and simulated curves (dotted lines); [7 Modified].

The  $D$  and  $S$  coefficients, calculated by reverse method from the average sorption curves of bare wood specimens are  $D = 1.5 \times 10^{-10} \text{ m}^2 \text{ sec}^{-1}$  and  $S = 1.1 \times 10^{-7} \text{ m sec}^{-1}$ . These data agree with the literature [2 3]. The  $P$  coefficient of each combination of layers was then calculated from the corresponding average sorption curves maintaining  $D$  constant. Experimental average curves and simulated curves are shown in figure 1 (right). The correspondence between them is always excellent demonstrating the good adherence of the model to the physical phenomena.

The average  $P$  values are reported in the left histogram of figure 2. Those data can be compared with the right diagram concerning the  $P$  values of different painting layers replicated according to techniques and materials used in the period from late Middle Age to Renaissance, calculated with the same method [7].

In both histograms the  $P$  value of the right Y axis of the graph shows the corresponding scale of the relative permeability  $P^*$  defined as  $S/P$ , the ratio between uncoated ( $D0$ ) and coated surface resistance.  $P^*$  may be also read as a measure of the asymmetry of the mass transfer responsible for transient deformations in panel painting.

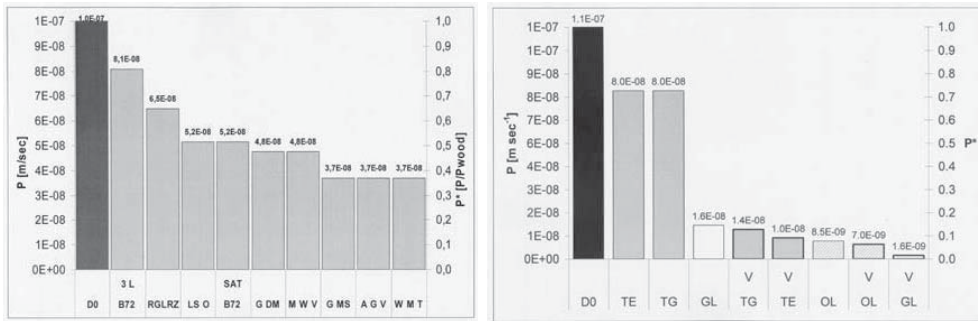

Fig. 2. Average  $P$  arranged in decreasing order. Left diagram: varnishes described in this paper; Right diagram: different painting layers combination composed by: animal glue + gypsum + [TE (Tempera Egg); TG (Tempera Glue); OL (oil); GL (Gilding on bole)] + absence or presence of one layer of Mastic Varnish in turpentine (V).

The picture provided by the experimental results presented in this paper should be considered as incomplete because no information was collected concerning the influence of factors such as temperature, RH, hysteresis, the thickness of the coating layers and the consequences of ageing on the barrier effect due to long-term mechanical, physical or chemical processes. It is known that chemical processes occurring for decades and centuries in oil paint (polymerisation, hydrolysis, oxidation, soap formation) accompany changes in the mechanical properties with modification of stiffness and brittleness properties [14] and modification of the characteristics of the painted surface

(e.g.: occurrence of cracks, detaching, craquelure). The effects of such modifications on permeability is unknown and, because of the large number of variables involved, its quantification is a scientific challenge. Some ongoing experimental measurements of mass variation of 16th century panels, painted with oil on one face and exposed to environmental fluctuation in exhibition conditions show a much higher P-value than expected. Such data (to be published) seems to confirm a strong effect of ageing factors in increasing the permeability of painting layer.

## 6. Conclusions

This paper described a method for the characterisation of water vapour permeability of painting layers on wood. The permeability coefficient described and measured in the paper is a fundamental physical property of the material because it affects the hygroscopic and deformative behaviour of wooden objects. This is an important quantity for improving the efficiency of FEM-based application software which, lately, are becoming powerful tools in the field of restoration and conservation.

Because of the small number of samples tested, such results do not have a high statistical relevance but they do provide the first look at data never measured before. Further measurements are needed to assess the influence of thickness of coatings, ageing factors and several climatic parameters such as temperature. Moreover, the method could be extended to the characterisation of other materials such as consolidating additives and new substances used in restoration practice.

## Acknowledgements

The work was financed by the Autonomous Province of Trento (Italy) within a postdoctoral project carried out in close collaboration between CNR-IVALSA (Italian National Research Council - Timber and Trees Institute) and the Sovrintendenza dei Beni Storico Artistici in the Province of Trento (Italy).

## References

1. Uzielli, L. (1994): Danni causati ai dipinti su tavola da variazioni termo-igrometriche e loro prevenzione. In "Conservazione dei dipinti su tavola". L. Uzielli, O. Casazza eds., Nardini editore, Firenze, 109-149.
2. Siau, J.F. (1984): "Transport process in wood". Springer-Verlag, New York, chap. 6-7.
3. Avramidis, S. (2007): Bound water migration in wood. In "Fundamentals of wood drying". P. Perré ed., European COST A.R.BO.LOR., 105-124.
4. Morén, T., Salin J.-G. (1992): Determination of the surface emission factors in wood sorption experiments. In "Proceedings of 3<sup>rd</sup> International IUFRO Wood drying conference". Vienna.
5. Liu, J.Y. (1989): A new method for separating the diffusion coefficient and surface emission coefficient. *Wood and Fiber Science*, 21(2), 133-141.
6. Ciatti, M. (1999): Dipinti su tavola: riflessioni sulla storia della produzione e della conservazione dei supporti. In "Dipinti su tavola – la tecnica e la conservazione dei supporti". M. Ciatti et alii eds. EDIFIR, Firenze, 21-23.
7. Allegretti O., Raffaelli F. (2008): Barrier effect to water vapour of early european painting material. *Studies in Conservation*, 53 (2008), 187-197
8. Choong, E.T., Skaar, C. (1972): Diffusivity and surface emissivity in wood drying. *Wood and Fiber Science*, 4, 80-86.
9. Comstock, G. L. (1963): Moisture diffusion coefficients in wood as calculated from adsorption, desorption and steady-state data. *Forest Product Journal*, 13, 97-103.
10. Allegretti, O., Raffaelli F. (2007): WCHO's behaviour during seasonal RH fluctuation in heated churches in the Alps. Paper presented at COST IE0601 Workshop, Tervuren.
11. Fioravanti, M. (1994): Le specie legnose dei supporti: implicazioni per la conoscenza, la conservazione ed il restauro dei dipinti su tavola. In "Conservazione dei dipinti su tavola". L. Uzielli, O. Casazza eds. Nardini editore, Firenze, 83-106.
12. Crank, J. (1975): "The mathematics of diffusion". Clarendon Press, Oxford, 2<sup>nd</sup> ed., 224.

13. Wadsö, L. (1992): 'A test of different methods to evaluate the diffusivity from a sorption measurement'. In "Proceedings of 3<sup>rd</sup> International IUFRO Wood drying conference". Vienna.
14. Erhardt, D., Tumosa, C. S., Mecklenburg, M. F. (2005): Long-term chemical and physical processes in oil paint films. *Studies in conservation*, 50, 143-150.



# MICROTOPOGRAPHIC AND RUGOMETRIC INSPECTION OF WOOD ARTIFACTS

*Manuel F.M. Costa*

Department of Physics, University of Minho, Portugal  
mfcosta@fisica.uminho.pt

## Abstract

The inspection and characterization of the surface of wood artifacts and structures is very important both in defining the suitability of a certain kind of material for a specific application, and in studying its reaction to environmental constraints. Both 2D and microtopographic should be performed extensively and in a non-invasive way. Active optical triangulation based microtopographers, like the MICROTOP systems developed at th University of Minho, can be successfully employed on the rugometric characterization and microtopographic inspection of different wood surfaces.

## 1. Introduction

For several years [1,2] optical profilometers and microtopographers were developed by the author at the Physics Department of the Universidade do Minho aiming different applications. For several years the main microtopographer MICROTOP.03.MFC was successfully applied to the inspection of a large range of surface types and inspection tasks [1-11]. Over the years small improvements on its characteristics were made and special versions designed for particular applications like a portable set [4] and a system to be used in the inspection of polymers [9].

Recent requests [10,11] led us to improve the system incorporating a number of innovative features. Increased versatility, reliability, with larger measuring range, better accuracy and resolution that now can be driven down to the nanometer range, were achieved in the MICROTOP.06.MFC. Discreet active triangulation [1-3, 12-13] is the method employed. Essentially in this kind of sensors a beam of light shines on the sample at some angle and the reflected light is collected at another angle.

The general triangulation geometry is sketched below. Of particular interest are the situations: where the observation angle equals the incidence one, and we will be looking at the specular reflection achieving high height resolutions, on the nanometer range; and, when either normal observation (our choice as explained elsewhere [1]) or incidence is settled resulting on a geometry most suitable for the inspection of rougher surfaces, the most frequent case in industry. The relation between the lateral spots' displacement and height is easily established.

The former system, the MICROTOP.03.MFC, was based on a method involving optical active triangulation (figure 1.) with oblique incidence and normal observation, and mechanical sample's scanning. Now another triangulation arm is incorporated on the sensor's head allowing specular triangulation with resolutions down to the nanometer range [7]. Furthermore when using a linescan scan camera with 2048 elements, pitch 13mm, the roughness of smoother samples can be measured by an angular resolved scattering approach [14-15]. If on the specular observation arm the differential photodiode is employed resolution of a few nanometer are achieved on the inspection of smooth surfaces.

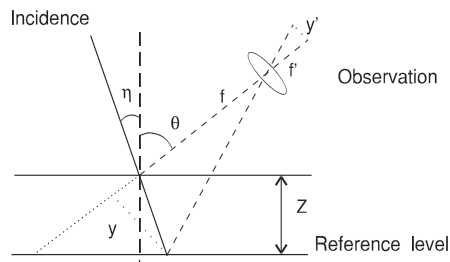

Fig. 1. A sketch of the general triangulation geometry.

## 2. The microtop.06.MFC system

The inspection system is based on active optical triangulation and angle resolved scattering. The setup and the inspection are briefly described next referring to figure 2.

The surface to be inspected is scanned by one oblique light beam. Two HeNe lasers at 632.8 and 534nm, and, one Xe white light sources are available and can be easily interchanged. The incident light is collimated and focused. A small, diffraction limited, bright spot is thus projected onto the sample. The bright spot is imaged both perpendicularly and specularly onto electronic photosensitive detection systems in order to assess its lateral position. The photosensors are one 2048 pixels Fairchild CCD linear array on the specular arm and a Reticon line scan camera. However, one PSD and a differential detector are available and can easily replace the linear arrays. The area of the surface to be inspected is scanned point by point by the “sensor’s tip” (the light beam focused onto the surface). The highest system’s robustness was sought. Also a high lateral positioning resolution and accuracy should be achieved. Thus both the incidence arm and observation arms of the sensor are kept fixed. In order to perform the sample’s scanning it will be moved by means of a precision XY displacement table driven by precision step motors. Piezo-driven motors allow positioning with nanometer resolution in a 1.5mm range.

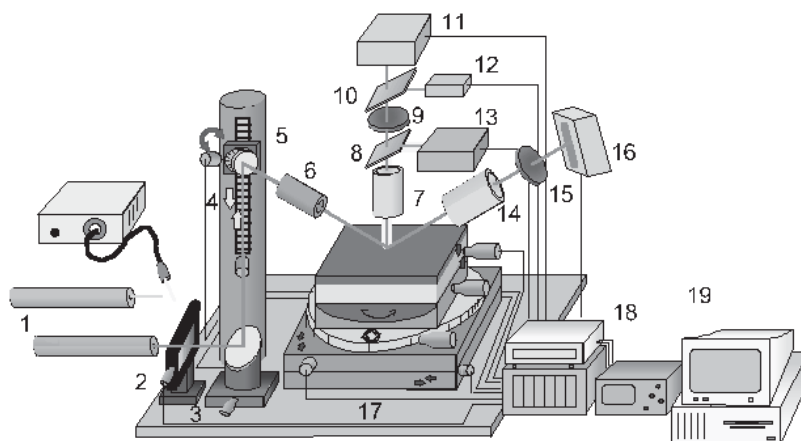

Fig. 2. 1. Interchangeable light sources; 2. Vibration isolation stand; 3. Neutral density filter; 4. Beam steering system; 5. Incidence angle control motorised system; 6. Incidence optics; 7. Normal observation optics; 8. and 9. Beam splitters; 10. Interference filter; 11. Normal photosensitive detection system; 12. Photodetector; 13. Video camera and illuminator; 14. Specular observation optics; 15. Interference filter; 16. Specular photosensitive detection system 17. Sample support and motorised positioning system; 18. Data acquisition and control system; 19. Microcomputer.

At each scanning point, on a rectangular array separated by distances down to 1.25 mm, the lateral spot's position in both sensors is obtained and registered. The spot's shift on both detectors' planes, between consecutive scan positions is directly related with the height differences between those surface' inspected points. In the “specular” of the system the detector can be positioned (just introducing an adapter) tilted relative to the observation optics in order to increase the depth range of the sensor (Schleimpflug' condition). Employing the linear arrays both arms are on a confocal arrangement allowing the best resolution.

The incidence set-up comprises apart from the light source a neutral density variable filter, a motorised beam steering system, a spatial filter and focusing optics. The change on the incidence angle is made synchronised with the change of the observation angle on the specular arm. A vertical movement precision stage endowed of computer controlled motion provided by a reliable accurate DC encoder with high positioning repeatability and resolution is used refocusing of the observation optical system but especially for calibration of both arms of the sensor. In order to resolve shaded areas and mutual reflections, a high precision rotational stage is used allowing easy change to opposite light incidence. Often the faces of the surface to be analysed are not parallel or simply the

surface to be inspected does not lie horizontally. In order to maintain the best height resolution a tilt table was incorporated to the samples' positioning system. Furthermore it may allow the inspection of 3D objects or surfaces with pronounced holes of it, for instance.

The observation optical systems are formed by microscope objectives chosen according to the characteristics of the surface's relief. In both sensor' arms the objectives can be independently focused. They will be used to image the light spot onto the opto-electronic photosensitive detection systems. Both the "normal" and the "specular" sensors' arms are attached to a XYZ precision displacement table for finer adjustments. A 2D CCD camera was attached to the system allowing the capture of bidimensional colour images of the scanned area for matching and improved visualisation aid. Projection of the actual 2D image onto the 3D map is being studied at the moment. In order to cope with different requirement different photosensitive systems are available and all are interchangeable. A personal microcomputer acquires the data and takes control of the whole inspection process and result's presentation. At the end of the inspection process we may have just one but typically will have two sets of data one for each sensor's arm. Data processing is independently performed and two sets of parameters and functions are obtained by triangulation and scattering analysis. The correlation of the sets of data is investigated. Comparison and matching is performed in order to obtain just one the best set of reliable and accurate data.

### 3. Microtopographic inspection of wood artifacts

In order to illustrate the potential of the system on the rugometric and profilometer inspection of wood samples, a reduced set results will be presented of the inspection art wood objects furniture or materials for construction. the large variety of types of wood in terms of relief, aspect or surface treatment, including varnishing, painting or gold coating for instance, demands different metrological strategies.

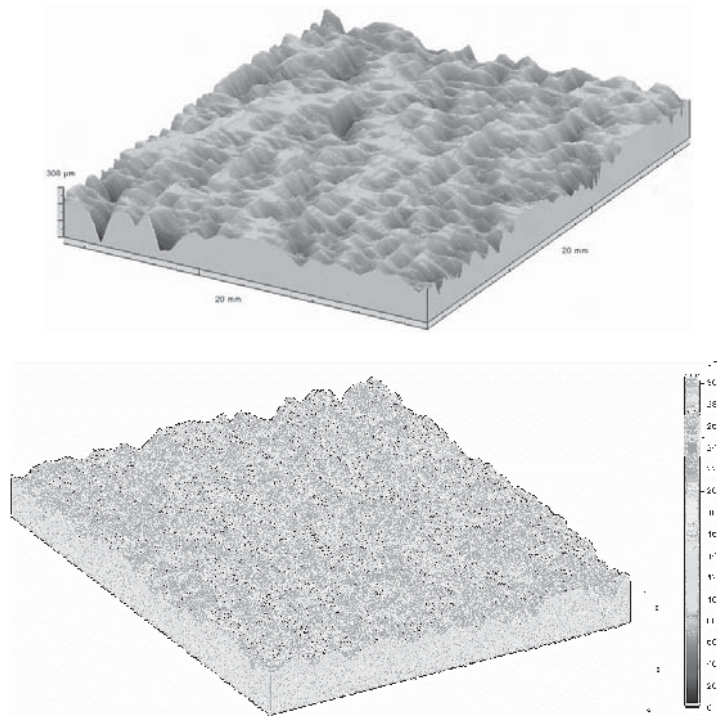

Fig. 3. Microtopographic inspection of a blackwood plate.

In order to be able to measure objects of large dimensions or that can not be moved portable systems can be used. However when higher lateral and height resolution is sought one can instead

obtain high quality surface replicas [6,7] that can then be carefully inspected in our main microtopographers. In figure 3. a photo shows a blackwood plate and the silicone replica obtained [7] as well as two relief maps of that surface (different views). One of the faces of the blackwood plate is varnished. In the following figures a relief map of the varnished surface is present for comparison.

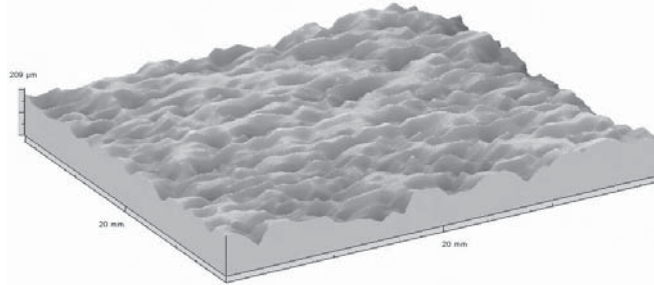

Fig. 4. Relief map of the varnished face of blackwood plate presented at figure 3.

Table 1. Comparison of roughness parameter on raw and varnished blackwood

Without varnishing	Varnished	Diference (%)
Ra = 51.96 μm	Ra = 47.47 μm	8,6
Rq = 69.74 μm	Rq = 58.97 μm	15,4
Rz = 303.89 μm	Rz = 208.79 μm	31,3
Sm = 403.13 μm	Sm = 2462.24 μm	
Rsk = -1.59	Rsk = -1.08	
Rku = 4.99	Rku = 2.98	

The varnishing process produces a significant decrease on surface’s roughness filling up at a significant level the pronounced valleys on the raw surface (figure 4.). In table 1. we quantify the differences in the most commonly used statistical parameters the system calculates [1,2,10].

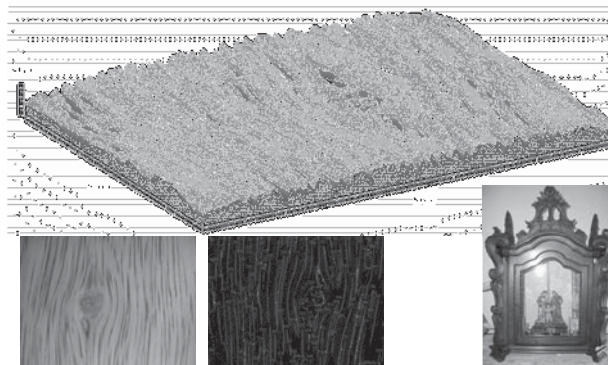

Fig. 6. Bi- and tri-dimensional inspection of a chestnut tree wood flat panel on a late XIX century Portuguese “mostruário”.

Chestnut tree wood was widely used in Portugal both in the production of quality furniture, statues

and other art pieces. A larger variety of art pieces are available on museums all over the country. Often the microtopographic inspection should be complemented by its 2D aspect characterization. In figure 5. a 2D picture, results of a blob analysis and relief map of a flat panel on a late XIX century Portuguese “*mostruário*” (on the left) used to preserve and show in churches, museums and upper class homes religious statues or icons.

#### 4. Conclusion

The inspection and characterization of wood materials structures and artefacts should be performed extensively and whenever possible in a non-invasive way. Optical triangulation based systems are being more and more and very successfully used in the inspection of wood artefacts. The microtop family of triangulation based microtopographers developed at the physics department of the university of minho proved to be an invaluable versatile and reliable tool on non invasive microtopographic evaluation of such kind of surfaces and structures.

#### References

1. Manuel F. M. Costa, J. B. Almeida (1988): Surface relief mapping. Proceedings of the International Conference on Industrial Inspection, D. W. Braggins, ed., Proc. Soc. Photo-Opt. Instrum. Eng. 1010, 193-199.
2. Manuel F.M. Costa (1996): Surface Inspection by an Optical Triangulation Method. Optical Engineering 35(9), 2743-2747.
3. Manuel F.M. Costa, J.B. Almeida (1993): System of Optical Non Contact Microtopography. Applied Optics 32, 4860-4863.
4. Manuel F.M. Costa (1996): Dimensional inspection of rough surfaces by optical triangulation. J. Indian Inst. Sci. , vol. 76, 279-287.
5. Manuel F. M. Costa, J. B. Almeida (1990): Surface microtopography of thin silver films. Proceedings of the International Conference on Optical testing and metrology III, C. P. Grover, ed., Proc. Soc. Photo-Opt. Instrum. Eng. 1332, 544-551.
6. Manuel F.M. Costa, V. Pinho (2001): Microtopographic Inspection of Thermoplastic Rubber Shoe Sole. The influence of surface roughness on sole to leather gluing. NDT&E Int. Journal, 34, 11-16.
7. J.G Rocha, C.G.J. Schabmueller, N.F. Ramos, S Lanceros-Mendez, M.F. Costa; A.G.R. Evans, R.F. Wolfenbittel, J.H. Correia (2003): X-ray detector based on a bulk micromachined photodiode combined with a scintillating crystal. J. Micromech. Microeng., 13, pp. S45-S50.
8. María del Carmen López Pacheco, Eva R. Gallegos, Aura J. Pérez Zapata, Judith D. Cherit, Manuel F. M. Costa (2005): Implementation and analysis of relief patterns of the surface of benign and malignant lesions of the skin by microtopography. Phys. Med. Biol., vol. 50, pp. 5535-5543.
9. Oliveira, MJ; Brito, AM; Costa, MC; Costa, MF (2006): Gloss and surface topography of ABS: A study on the influence of the injection moulding parameters. Polymer Engineering and Science 46 (10): 1394-1401.
10. Teixeira, V.; Sousa, E.; Costa, M.F.; Nunes, C.; Rosa, L.; Carvalho, M.J.; Collares-Pereira, M.; Roman, E.; Gago, J. (2001): Spectrally selective composite coatings of Cr-Cr<sub>2</sub>O<sub>3</sub>, and Mo-Al<sub>2</sub>O<sub>3</sub> for solar energy applications. Thin Solid Films, 392, 320-326
11. Manuel F. M. Costa; V. Teixeira; C. M. Nunes (1999): Microtopographic Inspection of Cr-Cr<sub>2</sub>O<sub>3</sub> Cermet Solar Absorbers. Proc. Soc. Photo-Opt. Instrum. Eng. 3789, 144-151.
12. M. Rioux (1984): Laser range finder based on synchronized scanners. Appl. Opt. 23, 3837-3844.
13. L. S. Tanwar, H. Kunzmann (1984): An electro-optical sensor for microdisplacement measurement and control. J. Phys. E: Sci. Instrum. 17, 864-868.
14. E. L. Church, H.A. Jenkison, J.M. Zavada (1977): Measurement of the finish of diamond turned metal surfaces by differential light scattering. Opto. Eng. 16, 360-374.
15. E. L. Church, H.A. Jenkison, J.M. Zavada (1979): Relationship between surface scattering and microtopographic features. Opto. Eng. 18, 125-136.

# PROTOCOLS FOR THE CONSTRUCTION AND CHARACTERIZATION OF MODEL PANEL PAINTINGS FOR THE EVALUATION OF STRUCTURAL DIAGNOSTIC TECHNIQUES

*Anna P. Moutsatsou<sup>1</sup>, Eleni Kouloumpi<sup>1</sup>, Johanna Olafsdottir<sup>1</sup>, Maria Trompeta<sup>1</sup>, Christina Tsaroucha<sup>1</sup>,  
Michael Doulgeridis<sup>1</sup>, Roger M. Groves<sup>2</sup>, Vivi Tornari<sup>3</sup>*

<sup>1</sup> National Gallery – Alexandros Soutzos Museum, Conservation Department, Laboratory of  
Physicochemical Research, Athens, Greece

<sup>2</sup> Institut für Technische Optik, Universität Stuttgart, Stuttgart, Germany

<sup>3</sup> Foundation of Research and Technology – Hellas, Institute of Electronic Structure and Laser,  
Heraklion, Crete, Greece  
annamoutsatsou@nationalgallery.gr

## 1. Introduction

The structural diagnosis of panel paintings is a procedure which investigates complex systems of materials and defects that in many cases are not visible to the naked eye. The development of structural diagnostic techniques requires model panel paintings that satisfactorily simulate original objects.

The usefulness of such models and the success of the protocols have been proved during the European Research Project “MultiEncode: Multifunctional Encoding System for the Assessment of the Cultural Heritage” (006427), yet in progress. The MultiEncode project aims to develop a novel *Impact Assessment Procedure* by exploiting the holographic technology advances and innovative tools. The proposed method relies on the original coded extraction of distinct features from an artwork prior to conservation, transportation and loan that characterize the state of preservation of the artwork and its originality. The coding and decoding of such characteristic features can be performed holographically and then optically and numerically transformed for digital archiving. The coded, archived data forming the signatures of the object can be compared at any later time to provide indication of induced alterations. [1]

The National Gallery’s participation at the project as an end-user includes:

- definition of “signature defects” of paintings on wooden panel and determination of the alteration processes and effects on their structure
- construction and characterization of model panel paintings required for the experiments
- assessment of experimental results and comparison with conventional techniques, etc.

## 2. Materials and methods

A protocol for the construction of model panel paintings should include:

1. Study of the typical structure of the paintings to be simulated
2. Determination of the deterioration factors
3. Definition of the defects that usually appear
4. Construction of the model panel paintings
5. Documentation and characterization
6. Ageing of the model panel paintings

For the construction of the model panel paintings, the typical construction technique of Byzantine icons was studied and documented (figure 1) [2, 3]. This type of panel paintings has been selected not only because of the importance in the history of east art, but mainly because of the complex structure.

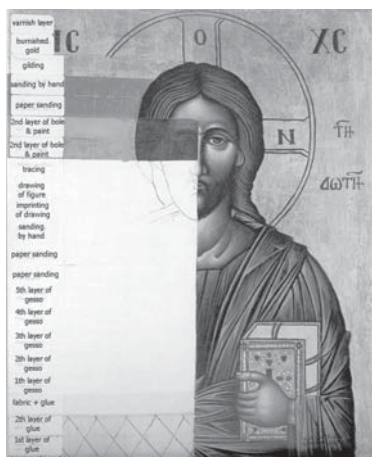

Fig. 1. Typical structure of traditional Byzantine icon.

Table 1. Table of the produced model panel paintings and their characteristics.

#	Technique	Layer Structure	Defects
1	Byzantine (with textile)	<ol style="list-style-type: none"> <li>1. wooden substrate</li> <li>2. incise the substrate [2, 3]</li> <li>3. textile</li> <li>4. preparation layer (gesso + animal glue)</li> <li>5. bole</li> <li>6. layer of gold</li> <li>7. paint layer (pigments + egg yolk)</li> <li>8. varnish</li> </ol>	<ol style="list-style-type: none"> <li>1. iron nails</li> <li>2. torn textile</li> <li>3. cracked wooden substrate</li> <li>4. substrate</li> </ol>
2	Byzantine (with textile)	<ol style="list-style-type: none"> <li>1. wooden substrate</li> <li>2. textile</li> <li>3. preparation layer (gesso + animal glue)</li> <li>4. bole</li> <li>5. layer of gold</li> <li>6. paint layer (pigments + egg yolk)</li> <li>7. varnish</li> </ol>	<ol style="list-style-type: none"> <li>1. knots</li> <li>2. partial loss of gilding</li> <li>3. gilding</li> <li>4. loss of ground layer</li> </ol>
3	Byzantine (with textile)	<ol style="list-style-type: none"> <li>1. wooden substrate</li> <li>2. textile</li> <li>3. preparation layer (gesso + animal glue)</li> <li>4. tracing – anthivolon [2, 3]</li> <li>5. paint layer (pigments + egg yolk)</li> <li>6. varnish</li> </ol>	<ol style="list-style-type: none"> <li>1. general ageing during preparation</li> <li>2. superficial cracking of gesso and paint layers</li> </ol>
4	Byzantine (without textile)	<ol style="list-style-type: none"> <li>1. wooden substrate</li> <li>2. preparation layer (gesso + animal glue)</li> <li>3. bole</li> <li>4. layer of gold</li> <li>5. paint layer (pigments + egg yolk)</li> <li>6. varnish</li> </ol>	<ol style="list-style-type: none"> <li>1. iron nails</li> <li>2. cracked wooden substrate</li> </ol>
5	Byzantine (without textile)	<ol style="list-style-type: none"> <li>1. wooden substrate</li> <li>2. preparation layer (gesso + animal glue)</li> <li>3. bole</li> <li>4. layer of gold</li> <li>5. paint layer (pigments + egg yolk)</li> <li>6. varnish</li> </ol>	<ol style="list-style-type: none"> <li>1. knots</li> <li>2. partial loss of gilding</li> <li>3. loss of ground layer</li> </ol>
6	Byzantine (without textile)	<ol style="list-style-type: none"> <li>1. wooden substrate</li> <li>2. preparation layer (gesso+animal glue)</li> <li>3. tracing – anthivolon [2, 3]</li> <li>4. paint layer (pigments + egg yolk)</li> <li>5. varnish</li> </ol>	<ol style="list-style-type: none"> <li>1. general ageing</li> <li>2. superficial cracking of gesso and paint layers</li> </ol>

The next step was the study of the typical factors of deterioration, such as environmental conditions, difference in the behavior of materials and layers, etc.

The study of the usual defects found on Byzantine icons led to the selection of these that are the most typical and can be characterized as “signature defects”. These are the defects that *have to be* reproduced by the construction of the samples in order to serve the holographic experiments.

Taking into consideration the typical construction of an icon, the factors of deterioration and the types of defect, it was decided to produce a list of 18 laboratory-made samples of all possible combinations of materials and defects. Six triples of samples were created, so that each of the three technical partners (see below) of the project would acquire all six types of samples (table 1).

Pine wood was selected, according to traditional handbooks that suggest softwoods as substrates for byzantine and post-byzantine icons [2, 3].

The documentation of one of the samples is presented in figure 2.

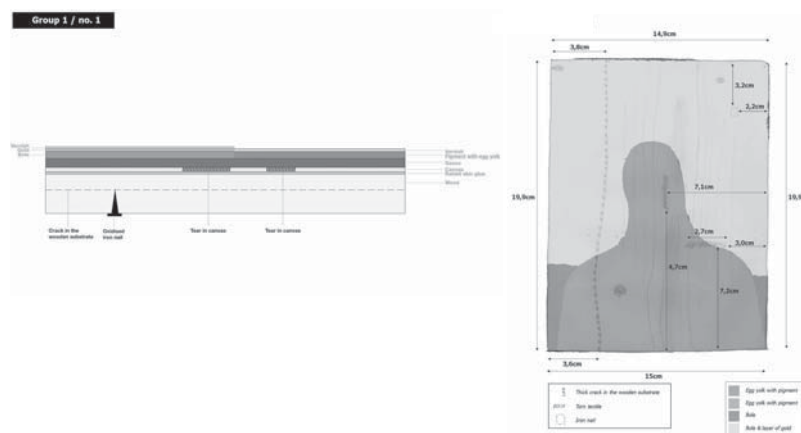

Fig. 2. Example of the documentation of the model panel paintings. Stratigraphy and defects.

The model panel paintings were sent to the three technical partners and they were examined by means of Digital Speckle Holographic Interferometry (Institute of Electronic Structure and Laser - IESL, Foundation of Research and Technology, Heraklion, Greece), Shearography (Institut für Technische Optik - ITO, Universität Stuttgart, Germany) and Dynamic Holographic Interferometry (Centre Spatial de Liège - CSL, Université de Liège, Belgium). Then they were sent back to the National Gallery for thermal treatment.

Referring to thermal treatment, it has to be noticed that the present experimental procedure aimed to provoke defects to the wooden substrates, in order to evaluate a novel structural diagnostic methodology. Most of the international standards (ISO, ASTM, etc.) referring to artificial ageing of wood, aim to test products that prevent wood degradation. Furthermore, the authors of the NG have not come across any published scientific work focused on artificially aged wooden samples that imitate old artistic substrates. The protocol followed at the first stage of thermal treatment of the model panel paintings is presented in table 2. The procedure was performed in a thermal chamber (Memmert Company) with maximum air recycling.

The samples were then examined again by the technical partners. At a third stage, some of the samples were further treated whereas others were restored and then treated again. Finally, they were holographically examined again.

### 3. Results and Discussion

A typical example of results obtained from holographic analysis of a representative model panel painting is presented in figure 3.



Table 2. The protocol followed at the first stage of the thermal treatment of the samples.

Group	Sample	Thermal protocol
1	All	Continuous heating at 102°C for 480 hrs
2	All	Heating at intervals at 102°C for totally 66,5 hrs
3	1 (IESL)	Continuous heating at 102°C for 17,5 hrs
	2 (CSL)	Continuous heating at 102°C for 46hrs
	3 (ITO)	Continuous heating at 102°C for 141 hrs
4	All	Continuous heating at 85 °C for 247 hrs
5	All	Continuous heating at 60°C for 66,5 hrs Continuous heating at 90 °C for 148 hrs
6	All	Same as GROUP 2

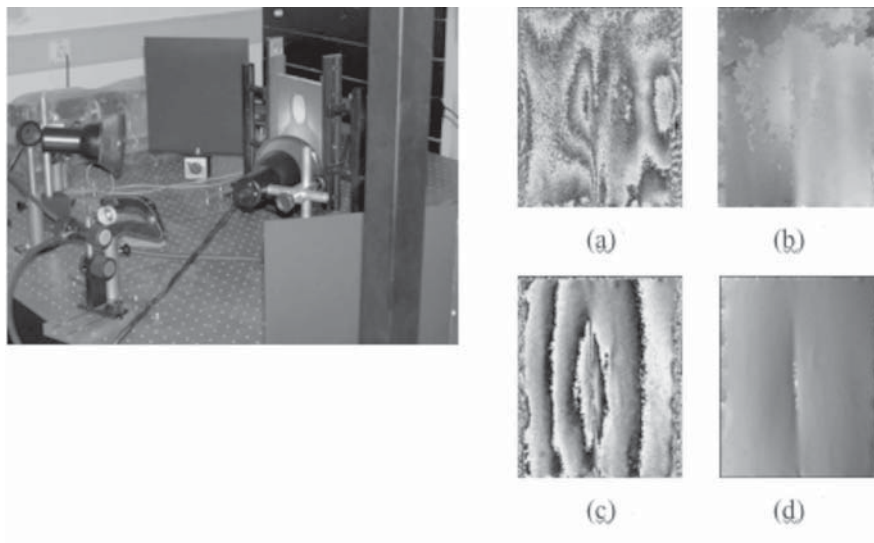

Fig. 3. Examination of sample no.3, group 3 by means of shearography instrumentation at ITO, Stuttgart. Shearography phase map (a) and unwrapped image (b) before thermal treatment and shearography phase map (c) and unwrapped image (d) after continuous heating at 102°C for 141h. [4, 5].

As it can be seen, the change in the sample due to the thermal treatment is very clear. The vertical linear feature in the phase map (a) is, by visual inspection of the top and bottom edges of the sample, a crack. The relative strain levels at the crack are higher in the aged model painting (phase map c) indicating that the crack has become larger. Also a change from the smooth surface texture can be seen. One possibility is that the paint layer is being detached from the wood at these points. [4]

#### 4. Conclusions

The protocol followed for the construction of model panel paintings by the National Gallery of Greece at the framework of *MultiEncode* European Project has successfully served the aims of the holographic experiments. Among the purposes was to detect the defects produced, to differentiate

the stable and unstable defects, to monitor the alterations produced by thermal treatment, to develop the impact assessment procedure, to develop an integrated system and to create analytical protocols suitable for panel paintings. The documentation of the model panel paintings has also been proved valid and essential. Further research should be focused on complete protocols for accelerated ageing of model panel painting and imitating old wood for artistic and conservation purposes.

### Acknowledgements

The Multi-Encode project ((006427 (SSPI)) is funded by the European Union and the authors would also like to thank Kostas Hatzigiannakis, Yannis Orphanos and Irini Bernikola at the Institute of Electronic Structure and Laser, Forth, Wolfgang Osten at the Institut für Technische Optik, Universität Stuttgart, Marc Georges and Cédric Thizy at the Centre Spatial de Liege, Université de Liege and Guy-Michel Hustinx at OPTRION s.a. for their collaboration.

### Bibliography

1. <<http://www.forth.gr/ae-iesl-accessible/projects/multiencode/>>.
2. Ek Fourni, D. (1906): *Η ερμηνεία της ζωγραφικής τέχνης* (The interpretation of the art of painting). Papadopoulou-Kerameos, (ed.) Petroupoli, B. Kirschbaum.
3. Kontoglou, F. (1979): *Έκφρασις της ορθόδοξου αιογραφίας* (Expression of the Orthodox hagiography), Vol. 2. Athens, Astir.
4. Kouloumpi, E. et al. (2008): Laser-based structural diagnosis: A museum's point of view. Proceedings of the International Conference LACONA VII, Madrid, Spain, 17-21 September 2007. CRC Press, Leiden, 407-411.
5. Groves, R.M. et al. (2008): "Development of an impact assessment procedure for artwork using shearography as measurement tool". Proceedings of the International Conference LACONA VII, Madrid, Spain, 17-21 September 2007. CRC Press, Leiden, 427-432.

# INVESTIGATION OF PAINT LAYERS OF THE FIFTEENTH CENTURY SAINT BARBARA POLYPTYCH FROM THE COLLECTION OF THE NATIONAL MUSEUM IN WARSAW

Krzysztof Chmielewski<sup>1,2</sup>

<sup>1</sup> Faculty of Conservation and Restoration of Works of Art, Academy of Fine Arts in Warsaw, Poland

<sup>2</sup> Inter-Academy Institute for Conservation and Restoration of Works of Art, Academy of Fine Arts, Poland  
chmiel@asp.waw.pl

## Abstract

The numerous analytical examinations of the material structure of the Master of St. Barbara's Polyptych (1447) were carry out (dendrological researches, micro chemical analysis, electron microscope, neutron activation and chromatography analysis, X-ray and infrared observations). The technical structure of the paintings was established and compared to the other works attributed to the Master's workshop.

## 1. Introduction

The polyptych of the Master of St. Barbara, at present in the National Museum in Warsaw, was painted in 1447 for a small church of St. Barbara in Wroclaw. Its author, an anonymous Master, came to Silesia from the West of Europe. Historians of art have for years been divided on the question of whether he learnt his craft in Nuremberg, Bavaria, Austria, Italy or the Upper Rhineland. One thing seems certain: he was familiar with the painting of Netherlandish masters of the first half of the fifteenth century. This is unmistakably confirmed by realistically noted elements of nature in his work. The style and paint technique of the Master of St. Barbara's Polyptych had great influence on the late gothic painting not only in Silesia but also in Little Poland and other regions in Central Europe. Originally the retable of the altar was a large, double-locked polyptych, of which only the central part has been preserved.

It is composed of five panels in original frames. The main panel shows standing figures of St. Barbara, Felix and Adauctus and, iconographically, is a *Sacra Conversazione* type of representation. The four smaller side panels depict scenes from the life and martyrdom of St. Barbara. Each of them, apart from its painted parts, features a finely decorated gilded background in the ground layer.

Moreover for many years the polyptych drew the attention of specialists but nobody analyzed its technology. It was the main target of the special research program realized during the few last years. The following examinations were undertaken: dendrological researches, micro chemical analysis, electron microscope, neutron activation and gas chromatography analysis, X-ray and infrared observations and photographs.

Thanks to these it was possible to establish exactly the technical structure of the paintings, the chemical composition of the individual technological layers, the methods by which ornamental decoration had been applied, and the character and structure of the paint media. Since the Master of the Polyptych of St. Barbara apparently exerted some influence on other works of Silesian painting, the same methods were used to examine seven of them, those which as regards their artistic form are closest to the St. Barbara Polyptych. These were: *a panel with a scene from the life of St. James, the Crucifixion Triptych, Veraikon from St. Barbara's church in Wroclaw, Veraikon from the church of the Blessed Virgin Mary in Legnica, the Madonna and Child, the Madonna and Child in a room, and a triptych endowed by Piotr Wartenberg.*



Fig. 1. Polyptych of St. Barbara, 1447, National Museum in Warsaw.

## 2. Results of analysis

Dendrological examination helped to establish the kinds of wood used for the support of all the paintings. Four panels of the St. Barbara polyptych are of spruce wood (*Picea abies*), and one is made of fir (*Abies alba*). The central big panel consist of 8 vertical boards and each of the four smaller panels consist of 5 boards. Dendrochronological research failed to yield positive effects. Only the relative ages of the individual blocks were determined. All blocks were carefully measured; the direction of the arrangement of grains was established, and the parts of the tree trunk from which each block was cut out were identified.

The X-ray photographs revealed that on each panel there is canvas applied directly to the wood under the layer of the ground.

A number of small samples were taken from all panels, and cross-sections were made of some of them. Thanks to these it was possible to observe the structure of ground and paint layers and analyse their chemical components.

Several thin ground layers of chalk in animal glue were applied onto the panels. It was established that the decorative tracery and ornamentation of acanth leaves in the background of all five panels were made by engraving in the ground and by the *pastiglia* method, and then covered with a coat of bole and gold.

Under the paint layer, black underdrawing lying directly on the ground is visible on infrared photographs. This is executed in black paint and served to outline the main elements of each composition, such as the oval of faces, the shape of hands and the robes of the figures. The underdrawing, which is definitely of a preliminary, preparatory character, was made in free hand in a fine line.



Fig. 2. St. Barbara, fragment of Fig. 1.

Fig. 3. St. Adauktus, fragment of Fig. 1.

The coats of paint include layers of underpainting, modelling and overpainting. The compositions of the ground and paint layers were examined with the help of classical methods and energy-dispersive X-ray microanalysis. In the ground layer chalk with a minute admixture of gypsum was identified. In the paint layers a number of pigments were identified, including: lead white, vermilion, red earth, azurite, lead-tin yellow, malachite, verdigris, carbon black.

The method of neutron activation analysis was used to test lead white and determine the kind and quantity of trace elements it contained. It was established that the lead white used in the polyptych of St. Barbara differs considerably from the lead white, tested by the same methods, in a number of sixteenth century panel paintings from the area of Southern Poland (Malopolska). It was possible also to determine similarities and differences between the lead white from the polyptych and the lead white taken from the remaining seven pictures mentioned above.

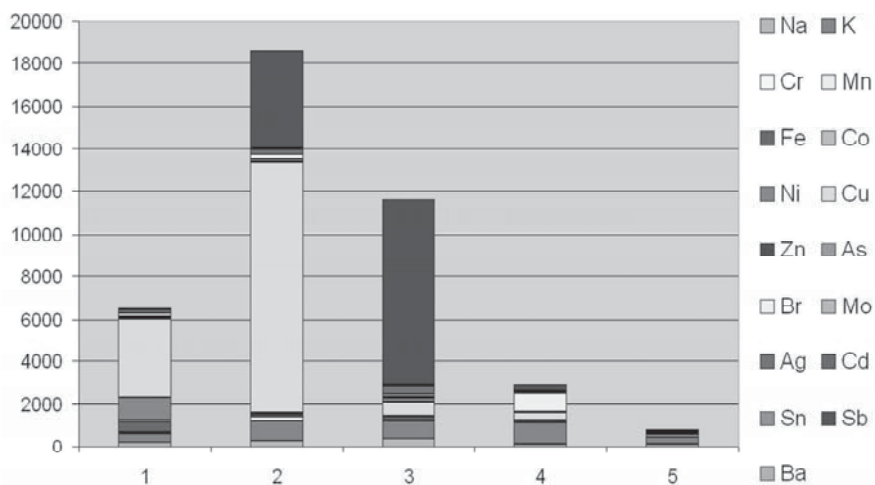

Fig. 4. Neutron activation analysis of five lead white samples from St. Barbara's polyptych. Trace elements distribution.

In the ground glutin adhesive was identified. Analysis carried out by the method of gas-liquid chromatography helped to identify the paint mediums: egg tempera in the lower layers and walnut oil with pine resin in the upper layers. The paint film has a character typical of fat tempera techniques: a layered structure and soft transition between light and shade. Nimbuses, inscriptions and decorative patterns on some robes were laid in paints with an oil-resin medium directly on the layer of the gold.

The relief brocade technique was used to decorate robes of saints in central scene of polyptych. This technique of decoration executed in low relief imitated real brocade textile and was popular in Late Gothic period especially in Germany but also in the Netherlands, Spain and sporadically in Italy. Thin flakes of relief brocade impressing from plastic glue-chalk or wax-resin masses were applied onto the surface of the pictures, gilded and painted. The grooving of flakes imitated the lay-out of threads in woven fabric. The brocade relief decoration on the Polyptych of St. Barbara is the first example of using this technique in the Silesian panel painting.

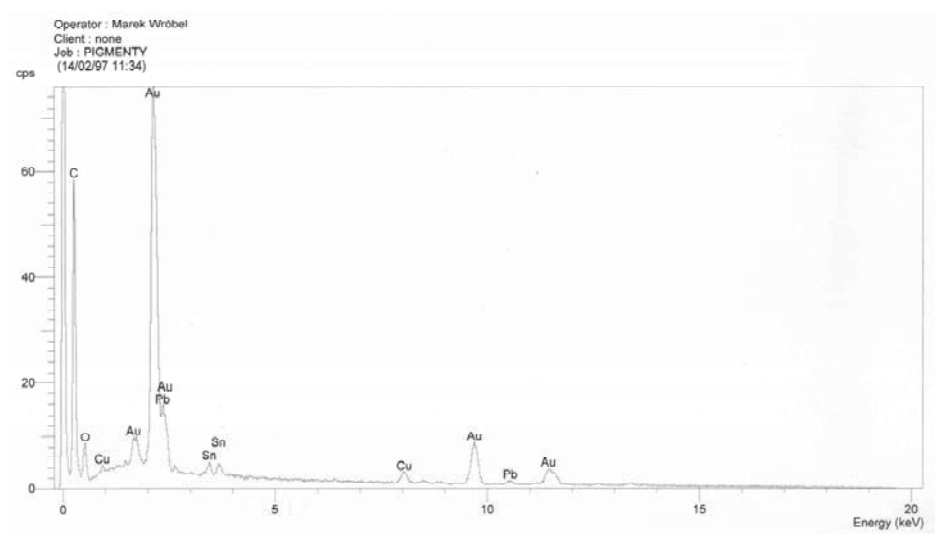

Fig. 5. SEM-EDS analysis of brocade decoration sample where the gold was identified.



Fig. 6. Polyptych of St. Barbara, fragment; infrared photo.

### 3. Conclusions

The same analytical techniques were used to examine the other seven works of Silesian painting which their artistic form is closest to the Polyptych of St. Barbara. In the case of each of the works tested, we tried to establish the relationship between the painting technique and materials used on the one hand and the final artistic form on the other.

From the techniques point of view the Polyptych of St. Barbara is a complex work in which typically painting media coexist with sculptured elements, for example the fully modeled decoration in the backgrounds. Thus the elements shown were rendered more real by means of both two-dimensional painterly illusion and genuine three-dimensional plasticity. For instance, some decorative patterns on draperies were painted illusionistically, and some (e.g., patterns on brocade) were given a spatial form and pasted onto the painting. Thanks to the application of appropriate adhesives and multi-layered method of painting, the elements shown (figures, their faces, finely adorned robes, details of architecture and landscape), all gain a realistic character. On each panel space, colour, light and shade are mutually harmonized, as a result of which the effect is that of convincing reality. On the other hand, the gilding widely applied on all panels produces a special kind of tension between the abstract background and the real nature of painted elements. This is a typically Late Gothic feature, as is also the application of both innovative technical methods and more traditional, backward methods. The Polyptych of St. Barbara is a good example of the breakthrough that was taking place in the fifteenth century: of the gradual departure from complex sculpting and painterly techniques towards typically painterly media.

Having compiled the results of all tests and analyses of X-ray and infrared photographs, was carried out a technological comparison of the Polyptych of St. Barbara and the other works under examination. The conclusion is that the polyptych shares particularly many features with the panel of St. James. The analysis of the painting technique confirms the theoretical hypothesis that this panel was painted directly in the workshop of the Master of the Polyptych of St. Barbara. Similarities with the other works, though they do exist, are not so obvious.

### References

1. Bomford D., Duncerton J., Gordon D., Roy A. (1990): *Art in the Making. Italian Painting Before 1400.*
2. Duncerton J. Foister S., Gordon D., Pennt N. (1991): *Giotto to Dürer. Early Renaissance Painting in National Gallery, London.*
3. Labuda A.S. (1984): *Wrocławski oltarz sw. Barbary i jego twórcy. Studium o malarstwie śląskim połowy XV wieku.*
4. Ligeza M., Panczyk E., Walis L. (1994): Identification of the 15<sup>th</sup> and 16<sup>th</sup> century panel paintings of the Cracow – Nowy Sącz School by means of instrumental neutron activation analysis, *Proceedings of the 4<sup>th</sup> Conference on Non-Destructive Testing of Works of Art, Berlin, 3–8 October 1994.*
5. *Malarstwo Gotyckie w Polsce. Synteza, pod red. Adama S. Labudy K. Secomskiej: (2004)*
6. *National Gallery Technical Bulletin, Early Northern European Painting (1997): vol.18.*
7. Olszewska-Swietlik J. (2002): *Warsztat malarski Mistrza ołtarza ze Strzegomia (1486/87).*
8. Panczyk E., Ligeza M., Walis L. (1992): Trace elements in white lead and grounds of panel paintings from the beginning of the 16<sup>th</sup>, *Proceedings of the 3-rd International Conference on Non-Destructive Testing, Microanalytical Methods and Environmental Evaluation for Study and Conservation of Works of Art, Viterbo 4–8 October 1992.*
9. Panczyk E., K. Chmielewski, Walis L., Kalicki A. (1996): Identification of the 15<sup>th</sup> century panel paintings of the Silesian School by INAA, *Radioisotope and Radiation Application in Industry and Environment, 20–23 October 1996.*
10. *Sztuka na Śląsku XII–XVI w. katalog zbiorów pod red. B. Guldán-Klameckiej: (2003).*

# DIAGNOSING EFFICIENCY OF CLEANING OLD WOODEN OBJECTS USING NEW O/W MICROEMULSIONS WITH ENVIRONMENTAL FRIENDLY COMPONENTS

*Ludmila Otilia Cinteza<sup>1</sup>, Gheorghe Niculescu<sup>2</sup>*

<sup>1</sup> University of Bucharest, Physical Chemistry Department, Bucharest, Romania

<sup>2</sup> National Research Institute for Conservation and Restoration, Bucharest, Romania  
niculescu.geo@gmail.com

## **Abstract**

New O/W microemulsions based on non-ionic surfactants (alkyl-polyglucoside, sucrose esters and polymer surfactants) were prepared and their cleaning efficiency was evaluated. The new microemulsions were tested as an alternative to classical method based on pure solvent used to remove dust, soot and grease from wooden objects surface. The O/W nanosystems were obtained by using mixtures of surfactants and synergistic effects were considered in order to prepare microemulsions with the minimum content of surfactants. The size and size distributions of the nanodroplets in the microemulsions have been characterized by dynamic light scattering method. The cleaning efficiency was evaluated through the contact angle, FTIR spectra and SEM images. A fluorescent compound has been encapsulated in the microemulsion in order to check the removal of the formulation from the wood surface after the cleaning procedure. These new nanostructured systems show promising results in the cleaning procedure of ancient wooden objects in art conservation and allow the use of low solvent concentrations and nontoxic biodegradable surfactants.

## **1. Introduction**

Conservation scientists are today interested in using more and more innovations from material sciences, especially from nanosciences or from recent improvements in technological equipment in order to do their work more rapidly, more precisely and in a less damaging way then before.

When dealing with valuable cultural heritage, researchers have constraints in choosing the right solution for cleaning procedures in order to obtain good results in removing the dirt and to produce no chemical or mechanical damage to the surface and, moreover, not to leave residues on the surface after the cleaning agent removal.

During the last decade, several type of nanostructured systems such as gels and microemulsions for surface cleaning have been developed for the art conservation and restoration domain [1-3].

The application of ESEM technology to cultural heritage conservation includes several applications such as reaction kinetics and micro to nanoscale material behaviour [4,5]. In spite its limitation, ESEM shows a significant potential as an easy method for the assessment of cleaning efficiency of the treatment applied to wooden surfaces.

Some other methods commonly used to characterize physical and chemical parameters of surfaces or nanosystems (such as the surface energy or size distribution of the nanoparticles) could be also used in the evaluation of cleaning efficiency. For example, the variation of surface parameters, made evident by the contact angle values, is directly related of the presence of hydrophobic or hydrophilic residues on the wooden surface and can be used as a measure of contaminants removal by cleaning.

In this work some cleaning formulations based on microemulsion with environmental friendly components were tested. Facile methods to check the surface energy and morphology were used, in order to prove the utility of simple and rapid diagnosing methods of the efficiency of the cleaning procedure with microemulsions.

## **2. Experimental**

### **2.1. Materials**

Sodium dodecyl sulphate SDS, commercial alkyl glycoside APG (Plantacare 50% aqueous solution from Fluka) Triton X 100 (4-1,1,3,3-Tetramethylbutyl phenyl-polyethylene glycol) and sucrose laurate were used as surfactants. All reagents are analytical grade.

As oil phase in the microemulsions xylene (Fluka reagent p.a) was used.

The fluorescence probe 1,6-diphenyl-hexa-1,3,5-triene (DPH) was used to prepare fluorescent micro-emulsions. The probe was encapsulated in the oily droplets of the microemulsions during the



preparation process (an adequate amount of DPH in chloroform was mixed in the organic phase to obtain a final concentration of  $1 \cdot 10^{-4}$  M in fluorescent derivative).

## 2.2. Methods

The cleaning efficiency of the new nanosystems was tested on samples of wood. Wood panels contaminated with smoke and organic wax were used, simulating the inner environmental conditions in orthodox churches, where wax candles are lighted in the proximity of painted wooden icons.

Different microemulsions were prepared (Table 1) using nontoxic compounds, by mixing appropriate amounts of water, oil phase (xylene), surfactant and co-surfactant. Surfactant or a mixture of surfactants were dissolved in the water phase until the micellar system becomes clear or homogeneous. Then, the oily phase was added drop wise, at room temperature, under continuous stirring, until the total xylene amount was incorporated. The microemulsion with Triton X-100 as stabilizer was prepared in the vial by mixing the aqueous phase containing the co-surfactant and the oily phase, under stirring, and by adding the surfactant drop wise, until a clear and stable system is obtained.

The formation of a “single phase” microemulsion in the studied systems was checked by direct observation of the samples.

The cleaning procedure consists in a gentle wiping of the test wood panels with a cotton swab soaked with the cleaning microemulsion. A rolling motion was used to remove dirt and smoke from the surface.

The size and the size distribution of the nanodroplets in the microemulsion were measured with a DLS instrument Zetasizer Nano ZS (Malvern) NIBS (non-invasive back scatter) module, in the range of 0.6nm - 6  $\mu$ m.

The fluorescent properties of cleaning microemulsions labelled with DPH dye were studied on a Jasco spectrofluorimeter FP-6300, with a Xe 150 W lamp, at 2.5 nm resolution. The excitation wavelength was  $\lambda_{ex} = 350$  nm. The residual traces of microemulsion left on the wood surface after cleaning were estimated by the fluorescence of the wood samples exposed to UV light (bacteriological UV lamp 5W,  $\lambda_{ex} = 365$  nm).

Fourier Transform Infrared (FTIR) spectra were obtained on a Jasco equipment. Samples of micro-emulsions collected after the cleaning procedure were prepared by mixing with spectroscopic grade KBr.

Contact angle measurements on the original and cleaned wood surfaces were performed with an OCA tensiometer (Data Physics) using drop shape analysis method. Water droplets (5-15  $\mu$ l volume) were automatic deposited with a Hamilton syringe and the contact angle was determined 30 sec. after the deposition, allowing the equilibrium to be established. The contact angle value reported is the average of 10 measurements.

The optical images of the wood samples collected before and after cleaning were obtained on a Zeiss optical microscope. The ESEM images were obtained on a FEI instrument Quanta 200 in normal mode.

## 3. Results and discussion

### 3.1. Microemulsions used as cleaning agents

The microemulsions prepared to be used as cleaning agents for wooden objects are formulated with surfactants or surfactant – co-surfactant mixtures of mild nontoxic compound category. Alkylpolyglucoside (APG), sucrose esters and Triton X-100 are such derivatives, with favourable physical, chemical and environmental friendly properties.

Various microemulsions were prepared based on these mild compounds with a different co-surfactant in order to obtain a single phase microemulsion. The oil-water ratio was kept usually to 0.3:1, with an exception for SDS/ 1-butanol and Triton X-100/SDS based microemulsions, where the ratio 0.3:1 needed larger amount of surfactant mixture to ensure a stable Winsor IV system.

Similar microemulsions based on APG as stabilizer were detailed described in the paper of P. Baglioni and co [1, 2], using a new synthesized APG derivative as co-surfactant.

From the phase diagram of the oil-water-surfactant-co-surfactant (O-W-SF-COSF) systems some

formulations were chosen as cleaning agents (Table 1).

Table 1. Microemulsions used as cleaning agents.

Micro-emulsion	Surfactant	Co-surfactant	Surfactant concentration	R = oil/water
A	SDS	1-butanol	25%	0.2/1.2
B	Triton X	SDS	20%	0.2/1.2
C	APG	FAES	25%	0.3/1
D	Sucrose laurate	1-butanol/GML 1/1	25%	0.3/1

In spite of the large amount of surfactant in the microemulsions C and D, these formulations were preferred due to their high content of oily phase.

Considering the content of oil, the presence of surfactants and the huge interfacial area specific for microemulsions it can be assumed that the selected systems would be very efficient in cleaning wax and smoke contaminants on a wooden surface.

### 3.2. Cleaning efficiency

In order to assess the cleaning efficiency of the nanoparticulate formulations some simple methods were used.

The size and size distribution of the inner oil cores in the micro-emulsions are changing as a result of the solubilisation of organic wax or of the smoke particles encapsulation.

In the fig. 1, the increase of oil droplet dimension proves that the microemulsion removes organic dirt from the wooden panel surface during the cleaning process.

Due to the presence of surfactants the microemulsions show high solubilisation capacity of organic wax in oil droplets, leading to the increase in size of the droplets from five to six times.

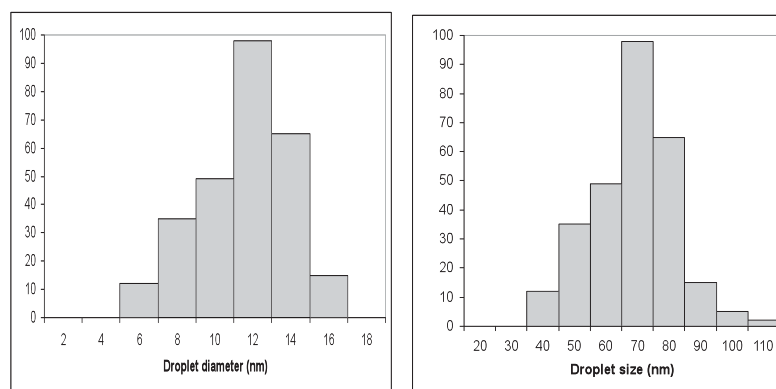

Fig. 1. Size distribution of droplets in the microemulsion D at cleaning a wood panel contaminated with organic wax (left) micro-emulsion as prepared; (right) sample of microemulsion after cleaning process.

The FTIR spectra of the microemulsion B used in the cleaning process demonstrate the presence of organic wax in the formulation, as a result of the solubilisation of the wax in the oil phase (data not shown).

The sample for FTIR analysis was prepared by dropping on the KBr powder a small amount of microemulsion collected after the cleaning of the wood surface contaminated with organic wax.

The obtained spectra show the specific bands of long hydrocarbon chains, C-H stretching vibrations at about  $3000\text{ cm}^{-1}$ , C-H bending at about  $1470\text{ cm}^{-1}$  and twin bands at  $720\text{ cm}^{-1}$  and at  $730\text{ cm}^{-1}$  similar to the spectra of original microemulsion. In region  $1700\text{ cm}^{-1}$  a peak is observed, corresponding to a carbonyl (C=O) stretching vibration of free carboxylic acid and of esters, a pattern similar with that of the wax sample used in the preparation of the contaminated wooden panel. Due to the complex formulation of the microemulsions used as cleaning agents, in

most of the cases FTIR spectra recorded at the end of the cleaning procedure is difficult to expose the existence of the wax residues in the samples. The removal efficiency could also be tested measuring the changes in surface hydrophobicity. In this respect, values of contact angle for water onto the wood surface were calculated (table 2) from the drops images recorded with OCA tensiometer.

Table 2. Contact angle variation for wood surface cleaned with different microemulsions.

Surface	Contact angle			
	Microem. A	Microem. B	Microem. C	Microem. D
Original varnished wood	46	46	46	46
Smoke contaminant	103	103	103	103
Wax and smoke contaminants	94	94	94	94
After cleaning procedure	65	67	58	55

The contact angles were measured on original varnished wood (as reference), on samples contaminated with smoke and organic wax, and the values were compared with the value recorded after cleaning treatment with different microemulsions. The increase of the contact angle value points to an increase of the surface hydrophobicity due to the presence of nonpolar contaminants –smoke (carbon black) and organic wax.

The decrease of the contact angle after the cleaning procedure suggests the removal of organic material from the wooden panel surface. Based on the variation of contact angle values, the C and D microemulsions show a significant cleaning efficiency.

One issue of the newly proposed cleaning products is conservators' fear that traces of products remain on the work of art surfaces, resulting in a permanent contamination of the object with residues of cleaning agents. Residues of solvent or surfactants adherent to the painted surface could produce in time significant change in the pictorial layer if it is not properly removed after the cleaning procedure.

The microemulsion was labelled with a fluorescent dye, DPH, encapsulated in the oily phase in order to check the residue of the new cleaning formulation on the wooden surface.

Figure 2 shows optical images of the wood surface cleaned with labelled microemulsion.

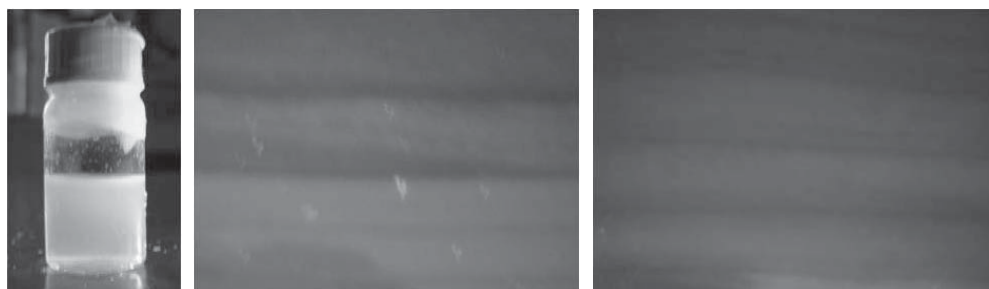

Fig. 2. Images of wood surface cleaned with fluorescent microemulsion. The samples was exposed to a UV lamp (excitation wavelength = 365nm.) (left) the cleaning formulation; (center) wood panel during the cleaning procedure with microemulsion (right) wood panel after the removal of the microemulsion.

The optical image of the wood surface under UV light shows no evidence of the dye labelled organic phase on the wood panel.

A preliminary result about the cleaning procedure efficiency could be obtained through observation under an optical microscope. In fig. 3 are presented images of a wood sample contaminated with carbon black by smoke exposure, before and after cleaning the surface with the C microemulsion.

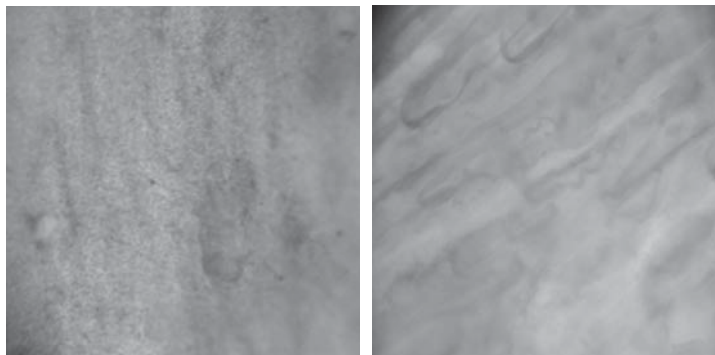

Fig. 3. Optical images of the wood panel surface contaminated with carbon black (a) and after cleaning with micro-emulsion C (b).

Similar images were obtained for all the formulation used, leading to the conclusion that the micro-emulsions based cleaning solution are efficient in removal the carbon black contaminants on the wood objects.

The efficiency of smoke and organic wax removal from the wood samples is evaluated through ESEM examination. ESEM images were used to evaluate the effect of the cleaning procedure in removal of carbon black and organic wax from the wood surface.

Samples from wood panel were collected after the experimental exposure to smoke and organic wax. The samples show both carbon black and bee wax residues in a non homogeneous layer.

Examples of analysis are presented in figures 4 and 5. The same samples were cleaned using the tested microemulsion (fig. 4- C microemulsion; fig 5 - D microemulsion).

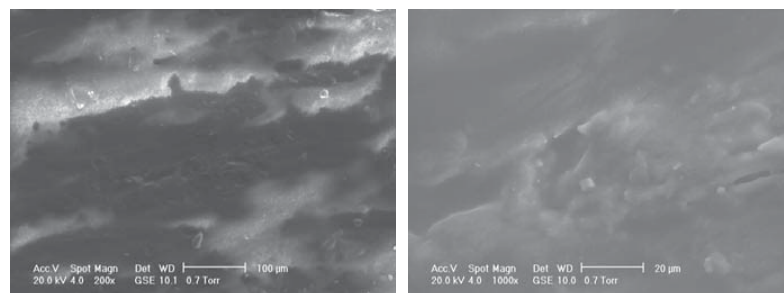

Fig. 4. ESEM images of wood sample contaminated with smoke (a) before and (b) after cleaning with the C microemulsion.

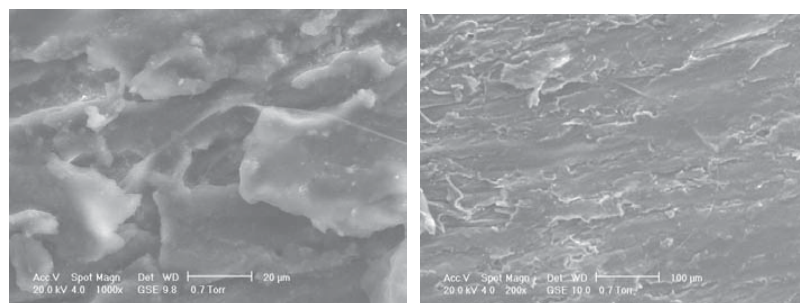

Fig. 5. ESEM images of wood sample contaminated with bee wax (a) before and (b) after cleaning with the D microemulsion.

Microscopic images show in both cases a significant removal of carbon black and total removal of organic wax.

#### 4. Conclusions

New O/W microemulsions based on nonionic surfactants as environmental friendly products were prepared and their cleaning efficiency was assessed.

Some simple methods to evaluate cleaning efficiency were tested: contact angle, variation of size distribution of the droplets in microemulsions, FTIR spectra, optical and scanning electron microscopy.

Microemulsions labelled with a fluorescent compound were used to evaluate the removal of cleaning agent from the surface. The residues of cleaning agent on the treated surface could be monitored by fluorescence spectra recorded after rinsing and by optical images under UV light.

The overall aspect of the wood is studied by ESEM micrographs of the original surface and of samples collected from the cleaned region.

The new nanostructured systems show promising results in cleaning procedure of old wooden objects in the art conservation using low solvent concentrations and nontoxic biodegradable surfactants. Subsequent studies will try to elucidate the action of these kinds of microemulsions on painting materials used in the decoration of art wooden objects.

#### References

1. Carretti E., Giorgi R., Berti D., Baglioni P. (2007): Oil-in-water Nanocontainers as low Environmental Impact Cleaning Tools for Work of Arts. *Langmuir* 23: 6396-6403.
2. Carretti E., Dei L., Baglioni P. (2003): Solubilization of Acrylic and Vinyl Polymers in Nanocontainer Solutions. Application of Micro-emulsions and Micelles to Cultural Heritage. *Langmuir* 19: 7867-7872.
3. Wolbers R. C. (1992): In Preprints to the Conference Restoration '92: "Conservation, Training, Materials and Techniques, Latest Developments"; V. Todd, J. Marsden, M. K. Talley, J. Lodewijks, V. Sluyterman, W. Koeno Eds., International Institute for Conservation of Historic and Artistic Works, London: 74-75.
4. Doehne E. (2006): ESEM Applications: From Cultural Heritage Conservation to Nano-Behaviour. *Microchimica Acta* 155: 45-50.
5. Giorgi R., Chelazzi D., Baglioni P. (2005): Nanoparticles of Calcium Hydroxide for Wood Conservation. The Decidification of the Vasa Warship. *Langmuir* 21 (23): 10743-10748.

**SESSION MANAGED BY WG3**



## UNDERSTANDING MICROBIAL DEGRADATION OF WATERLOGGED ARCHAEOLOGICAL WOOD

*Charlotte Gjelstrup Björdal*

Faculty of Forest Sciences, SLU (Swedish University of Agricultural Sciences), Stockholm, Sweden.  
charlotte.bjordal@sp.se

Waterlogged wood may be described as a wet tissue, where all capillary systems are filled with water, and from which air is consequently excluded. To be waterlogged, the wood has to be situated in a water rich environment, be it terrestrial or aquatic. Sea water, rivers, and lakes are typical examples of aquatic environments, whereas peat bogs, other wetlands, and soils with high water table are typical land site environments.

Waterlogged archaeological wood is often described as well preserved by archaeologists, due to the fact that to the naked eye the wood often looks completely intact regarding size, form and colour. All surface ornamentation and tool marks look as newly cut, and as long as the wood material is fully waterlogged, this appearance is maintained so that valuable recordings and documentation can take place. However, when pressed, it reveals a very fragile inner structure. Moreover, if the wood is left to dry, a dramatic change in the appearance will be observed; irreversible shrinkage, twisting and splitting will destroy all information within the surface layer and the integrity will be completely lost (Fig. 1). This behaviour has been experienced by archaeologists through time and conservation treatments have therefore continuously been developed since the 1850s in order to stabilise the wood so that damage to the integrity of the surface and dimensional changes are minimized upon drying.

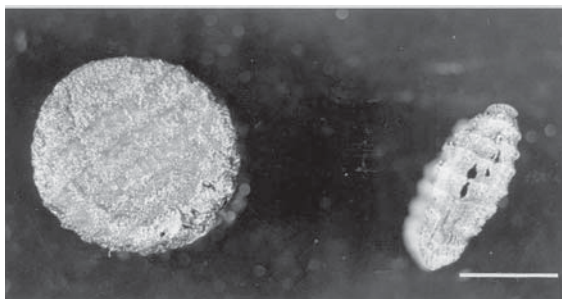

Fig. 1. Serious shrinkage and collapse of heavily degraded archaeological wood. Two discs of same dimensions, taken from a lance of ash wood (dated iron age), observed in wet (left) respective dry (right) condition. Bar: 1,3 cm.

The strange behaviour of waterlogged archaeological wood upon drying was initially hypothesised to derive from some kind of degradation process taking place inside the wood material. Chemical analyses revealed that the wood properties were changed. The amount of holo-cellulose was highly decreased compared to fresh wood, whereas the lignin was seemingly intact. Several suggestions on the cause of decay were discussed, and until 1990s it was a general assumption among conservators and wood chemists that the wood material was affected by acid hydrolysis during the long-term exposure in a waterlogged environment.

Meanwhile, in the field of degradation of plant tissue, wood biologists studied the microbial degradation of wood. With help of light microscopy, fungal attack was successfully identified, but occasionally also atypical decay patterns were reported. These came usually from foundation poles situated in a waterlogged environment. In a few reports from the 1940s -50s and -60s, it was suggested that these peculiar degradation patterns could be a result of bacterial attack on the cell wall of the wood. It was not until the 1980s, with help of electron microscopy with a much higher resolution than light microscopy, that it was possible to verify that wood from waterlogged environments was indeed degraded by specialized bacteria. Culturing experiments confirmed that



bacteria could degrade fresh wood even in the absence of fungi. At the Swedish university of Agricultural Science, research on the wood degrading bacteria, their habitat and identity has been ongoing since 1982.

In 1988, at an interdisciplinary international symposium on archaeological wood held in Los Angeles by American Chemical Society, these two fields of science met for the first time (Rowell, Babour, 1990). Wood biologists on one side, and conservators and wood chemists on the other side, two theories went up against each other. After a decade of discussions on the matter, a paradigm shift eventually took place.

Today, we know that the so called erosion bacteria are the most common degraders of archaeological wood found under waterlogged near anaerobic conditions. This is based on results from both experimental laboratory work as well as investigations on degraded archaeological wood from various terrestrial and aquatic sites world wide (Blanchette 2000; Björdal et al., 1999; Björdal et al., 2000). The bacteria are rod shaped and 2 – 8µm in length and 0.5 – 0.9µm in diameter (Fig. 2). Invasion starts from the wood surface through rays and pits, from where the bacteria enter the cell lumen of the tracheids. From here, the bacteria attack the wood cell wall and align themselves along the microfibrils. The bacteria convert the cellulose rich secondary cell wall into an amorphous slimy material, whereas the middle lamellae remain seemingly unaffected (Fig. 3). As a result, the coherent network of middle lamellae is still intact.

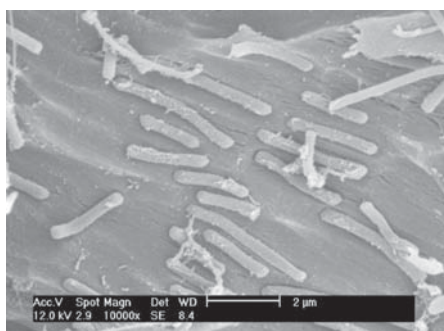

Fig. 2. Scanning electron micrograph (SEM), showing erosion bacteria degrading the wood cell wall. The bacteria are aligned in individual troughs and orientated along the microfibrils.

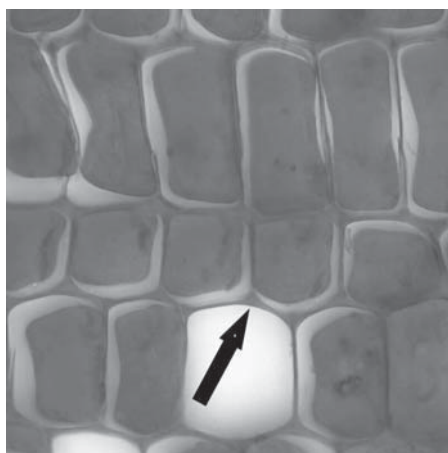

Fig. 3. The fibres are heavily degraded by erosion bacteria and the secondary cell wall material is transformed into a granular residual material. Only the middle lamella remains intact as a fragile network (arrow), which retain the integrity of each cell, so that dimensions and ornamentations of wooden objects are kept intact as long as the wood is waterlogged. Cross section observed using light microscopy.

We now know that bacteria have caused the gross deterioration observed in waterlogged wood. This also applies to very ancient wood; in certain environments decay by soft rot fungi may be

substantial. However, at present it is not possible to say if chemical deterioration also occurs over very long time. Numerous chemical analyses have been done on waterlogged wood, but the failures to distinguish between microbially degraded wood and seemingly sound wood, makes it difficult to conclude anything.

Erosion bacteria decay progresses slowly inwards until all cellulose rich areas are utilised. In a Viking pole, 1200 years old, this process was found to be still active in the interior parts (Björdal et al., 2000). This allowed us to conclude that the process may go on for thousands of years. The rate of decay is not just dependent on time of burial. In fact, it has been shown that environmental parameters and wood species may play a just as important role for progression of decay.

This was also found in the recent EU-funded project “BACPOLES” (EVK4-CT-2001-00043) from year 2002 – 2005, where attention was given to these bacteria and their environment. The goal of the project was to identify the bacteria species and to develop environmental-friendly tools for combatting the bacteria and prevent decay in foundation piles and archaeological wood. The erosion bacteria were found to be several different species belonging to the group of *Flavobacteria* and *Cytophaga*. These are commonly found in soil and water systems.

Reburial and in situ preservation of larger archaeological objects represent a new approach for preservation of wooden cultural heritage. This is an alternative to conservation treatments, which often are too expensive for “big size” objects such as shipwrecks, track-ways, and settlements. After being recording by archaeologists, the wood material can either remain in situ, or if the site is very aggressive towards wood, it is possible to remove the objects and rebury them in an environment better suited for preservation. Our knowledge on wood degradation and the relationship between decay type and environment enables us to distinguish between aggressive and passive environments for long-term preservation.

Based on this knowledge, it is possible to create tailor made reburial sites and in situ preservation sites. Recent studies on wood degradation in marine environment has shown that wood exposed at least 0.5m under marine sediment is fully protected from the aggressive woodborers and soft rot (Björdal et al., 2007a). Even decay by erosion bacteria declines with depth of burial and therefore this type of site management is a very promising field of development. The decrease in degradation with depth of burial is most likely due to decreasing oxygen levels. This is supported by laboratory experiments as well as from observations in the field. It also fits the general idea that low-oxygen-environments provide better preservation of organic remains. Had the old theory, that the degradation of wood is a result of acid hydrolysis, been true, it would have been difficult, if not impossible, to design optimal conditions for the preservation of waterlogged wood.

A successful preservation of larger wooden constructions like trackways and settlements in situ is dependent on a high and stable water table. Therefore, natural or artificial drainage of wetland gives rise to new problems regarding long-term preservation of cultural heritage. It has been shown that archaeological wood severely degraded by erosion bacteria during decades in near anaerobic environment, may be subjected to very aggressive white rot fungi when the environment changes and becomes more aerobic if the soil stays moist. (Björdal and Nilsson, 2002). Such attacks may lead to the ultimate and final decomposition of the wood.

By light microscopy it is possible to distinguish between degraded and sound wood tissue. Furthermore, it is possible for the trained eye to identify the type of decay and determine the main types of degraders. Fungi and bacteria leave unique fingerprints after the decay of a cell wall. In a recent research project, “Vasa Wood project”, funded by the Vasa Museum, Sweden, the aim was to investigate whether any chemical degradation of the Vasa hull had taken place after the salvage of the shipwreck in 1961. Our knowledge on microbial decay of wood and the ability to distinguish between biological degraded and wood not degraded by microorganisms was essential for the selection of appropriate samples for chemical analyses (Björdal and Nilsson, 2007c).

To bring a wreck on display in an aquarium in a normal museum environment is an innovative idea that was tested recently in a research project (Björdal et al. 2007b). By careful examination of test samples over a period of 3 years, it was concluded that archaeological wood would be even more protected from microbial decay inside an anoxic aquarium than at the seabed or in a lake. Thanks to the knowledge on wood degradation it is possible to test and develop new preservation ideas.

Today, impregnation with polyethylene glycol (PEG), usually in combination with freeze-drying, is probably the most common conservation method used world wide for waterlogged wood. Impregnation time varies between one year and almost a decade, and during this time, biofilm often develops around the wood surface and at the air/liquid interface unless biocides are added. The presence of mould, foam and slime raised the question if the wood is exposed to further microbial

decay during the impregnation stage. Results from an experiment showed that the micro-organisms found in PEG baths were harmless to the wood, and no degradation of wood cell walls took place (Björddal and Nilsson, 2001). Still, the slime development on the wood may have a negative impact, namely on the rate of impregnation. Wood situated in impregnation bath with slime development, may not be sufficiently impregnated, which in turn will lead to a conservation failure, first observable after freeze-drying.

For cultural heritage, knowledge of waterlogged wood and its decay processes is essential for development of adequate preservation methods. Without a correct diagnosis and an understanding of decay processes in nature, successful treatments and approaches are difficult, if not impossible, to achieve.

## References

- Björddal C.G., Nilsson T., Daniel G. (1999): Microbial decay of waterlogged archaeological wood found in Sweden. *International Biodeterioration & Biodegradation*, 43, pp. 63-73.
- Björddal C., Daniel G., Nilsson T. (2000): Depth of burial, an important factor in controlling bacterial decay of waterlogged archaeological poles. *International Biodeterioration & Biodegradation*, 45, pp.15-26.
- Björddal C., Nilsson T. (2001): Observation on microbial growth during conservation treatment of waterlogged archaeological wood. *Studies in Conservation*, 46, pp. 211-220
- Björddal C. G., Nilsson T. (2002): Waterlogged archaeological wood – a substrate for white rot fungi during drainage of wetlands. *International Biodeterioration & Biodegradation*, 50, pp. 17-23.
- Björddal C. G., Nilsson T. (2007a): Reburial of shipwrecks in marine sediments. A long term study on wood degradation. *Journal of Archaeological Science*. In press.
- Björddal C. G., Nilsson T., Petterson R. (2007b): Preservation, storage and display of waterlogged wood and wrecks in an aquarium: "Project Aquarius". *Journal of Archaeological Science* 34, pp. 1169-1177.
- Björddal C. G., Nilsson T. (2007c): Outline and results from the "Vasa Wood Project" with emphasis on the microscopic investigations. *Proceedings of the 10<sup>th</sup> WOAM group on wet organic archaeological materials conference*. Amsterdam, in press.
- Blanchette R. (2000): A review of microbial deterioration found in archaeological wood from different environments. *International Biodeterioration & Biodegradation* 46, pp 189-204.
- Rowell R.M., Barbour R.J. (Eds.) (2000): "Archaeological wood". American Chemical Society, Washington, DC.

# TARGET MICROCLIMATES FOR PRESERVATION OF WOODEN OBJECTS: AN ATTEMPT AT STANDARDIZATION

*Roman Kozłowski, Łukasz Bratasz*

Institute of Catalysis and Surface Chemistry, Polish Academy of Sciences, Kraków, Poland  
nckozlow@cyf-kr.edu.pl

## **Abstract**

The draft standard 'Specifications for temperature and relative humidity to limit climate-induced mechanical damage in organic hygroscopic materials' by CEN Technical Committee 346 proposes a novel approach to establishing target indoor microclimates suitable for the preservation of sensitive materials like wood. As the wooden objects have adapted over years to a particular indoor environment, the strategy focuses on replicating the past climatic parameters, like relative humidity, and specifies bands of tolerable short-term fluctuations superimposed on the average levels. However, criteria for defining tolerable fluctuations should be informed by numerical simulations and direct tracing of climate-induced damage in the objects.

## **1. Introduction**

In 2004, the European Standardisation Committee CEN established a new Technical Committee TC346 'Conservation of Cultural Property', chaired by Professor Vasco Fassina. The activities of the Committee have been grouped into 5 working groups:

1. General guidelines and terminology
2. Materials constituting cultural property
3. Evaluation of methods and products for conservation works
4. Environment
5. Transportation and packaging methods

The activities of the CEN/TC346 are an attempt at standardisation in such complex and delicate matter as conservation of cultural heritage. The main objective is to help conservation professionals by harmonising and unifying methodologies for the European area.

Issues of indoor environment in historic buildings were a subject area of Working Group 4. Among other drafts of standards, the group has prepared 'Specifications for temperature and relative humidity (RH) to limit climate-induced mechanical damage in organic hygroscopic materials' of which wood is the most common. Concepts contained in the draft will be used in this paper to answer a question: Is my indoor climate safe for conservation of wooden objects?

## **2. The criteria**

The answer to the question on the suitability of a particular indoor climate for long-term preservation of wooden objects can be based on two criteria – environmental and material. The first criterion would postulate that the climatic parameters the object is experiencing during exhibition, storage or transport should not exceed ranges and temporal variability of the climate pattern, to which the object has acclimatized over centuries. The environmental criterion is a relative one as it makes reference to a historic microclimate of a specific site. The second criterion would postulate that the disturbance of the climate, in terms of magnitude and rate of change, stays below a threshold variation above which risk of mechanical damage in the object appears. This is an absolute criterion based on properties and resulting response of the object to changes in the environment, which can be established by scientific research.

## **3. Historic climate**

The application of the environmental criterion to the assessment of the climate quality requires detailed knowledge of the historic indoor climate for each individual building. The description of the indoor microclimate history should provide long-term average levels and the band of short-

term fluctuations. Generally, this requires measurements over at least one year, or, if climate monitoring is not possible, reference can be made to similar buildings in the same climatic area. The procedure is illustrated by a case study of a historic wooden church of Saint Michael Archangel in Debno, Poland, dating from the fifteenth century. The church is a typical horizontal log construction and its small size was determined by the length of logs available for use. The interior preserves unique Gothic patterned wall paintings dated to around 1500 as well as ornate painted wooden decorations and furnishings (Figure 1).



Fig. 1. Wooden church of St. Michael Archangel in Debno, Poland. View of the interior.

The building is a relatively open structure with an indoor climate strongly governed by the outdoor weather due to a high rate of air exchange between inside and outside. A mathematical processing of historic climatic data has allowed defining a clear quantitative target microclimate for preservation. Figure 2 shows plots of the indoor RH data, sampled every fifteen minutes for one year, beginning in June and ending in May the subsequent year. The sampled data can be smoothed by calculating the running average in the two adjacent one month periods to obtain the seasonal variability. The yearly average is 71% and an increase in winter up to 80% and a decrease in warm period down to 55% are observed.

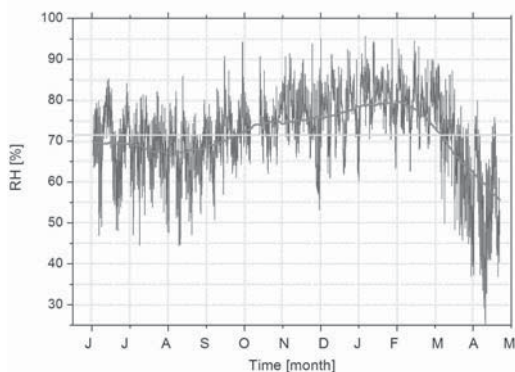

Fig. 2. Dębno wooden church. Indoor RH during one year measured at fifteen minute intervals (the blue line) and a general seasonal RH tendency (red line) obtained by calculating the two-month running average of the readings. The yearly average is marked by a horizontal line.

The seasonal variability is quite considerable with upward and downward deviations of around 9% and 16% respectively. Moreover, in absolute terms, the upward seasonal deviation of RH attains the upper limit of 80% above which attention should be paid to the risk of mould growth.

The short-term RH fluctuations, superimposed on the seasonal variations, are shown in Figure 3. They were extracted from the raw RH data by subtracting the running average from the instantaneous RH.

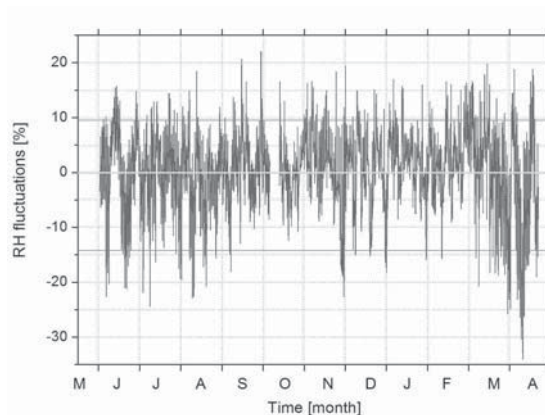

Fig. 3. Dębno wooden church – target band of tolerable fluctuations (marked by two red lines) compared to the observed variation in RH.

The lower and upper limits of the tolerable band, marked as straight lines, correspond to the 7th and the 93rd percentiles of the fluctuations, respectively. This means that 14 % of the largest, most risky fluctuations are cut off, which corresponds to  $-1.5$  and  $+1.5$  standard deviation in the Gaussian distribution of the fluctuation amplitudes. As a result, the target band is based on the 86% of fluctuations recorded in the past. The choice of the cut off level in the fluctuation magnitude should be based on the best available knowledge on the damaging effects of fluctuations; here a common statistical reference was selected.

#### 4. Numerical simulation

The material criterion has to be used when a new ‘artificial’ climate is replacing the historic one. A change in the function of a building in which the wooden object is housed, or a transfer of the object into a different microclimate – even a well-controlled museum environment – can be cases in point. A question is then raised as to the tolerable disturbance of the historic climate.

The answer is provided by analysis of the material response to climate variations using numerical simulations or direct tracing of damage in elements or objects. A massive wooden cylinder, simulating a wooden sculpture, constitutes one of the worst cases in terms of risk of climate-induced damage. It is caused by the hygroscopic nature of wood and the restrained dimensional response to the moisture sorption/desorption. For example, on reduction of RH, the moisture content gradient develops across the cylinder, as the moisture diffusion is not instantaneous and the outer part of the wood dries more quickly than the interior. The dry outer part is restrained from the shrinkage by the still wet core beneath, which results in mechanical stress: the outer shell goes into tension and the core into compression. The numerical techniques seek to change the continuous process of water vapour diffusion into a discrete one in the time and spatial domain, and calculate the stress field resulting from the restrained differential dimensional response [1].

Figure 4 shows maximum stress levels, calculated at the surface layer of a wooden cylinder 155 mm in diameter for an RH fluctuation corresponding to an episode of comfort heating switched on for a period of service in an unheated church interior. The heating was operated for a total duration of some 90 minutes and generated a rapid increase of temperature from 4 to 21°C accompanied by an approximately 30% fall in RH from 65 to 35%, followed by a slow return of both parameters to their initial values when the heating was switched off. The calculated stress of 2.7 MPa exceeded the tolerable level corresponding to the wood’s yield point. The amplitude of the fluctuation was systematically altered in the modelling; the RH variation of 20 per cent, i.e. the drop from 65 to 45%, was revealed as an allowable threshold.

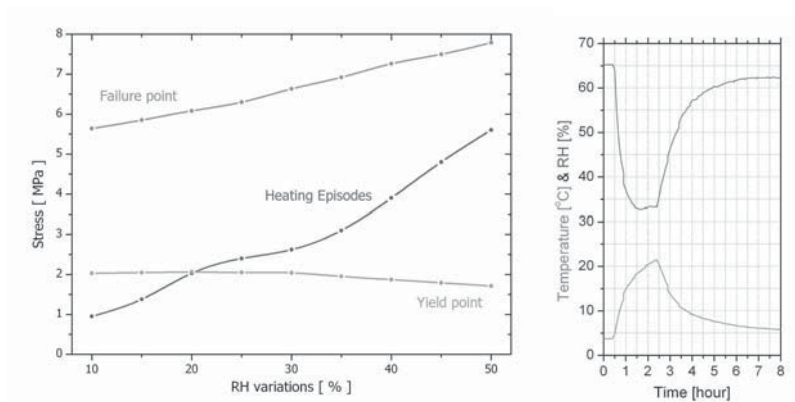

Fig. 4 Maximum stress calculated for a wooden cylindrical element versus magnitude of the RH fall (left) induced by short-term heating episodes (right).

## 5. Direct tracing of climate-induced damage in wood

Numerical simulations, however, cannot be relied upon as a fully adequate tool of the risk assessment. The principal problem is that the numerical simulations highly depend on the availability and quality of the material's parameters that may not be known a priori. Further, the modeling yields discrete values of the thresholds in the magnitude of the RH variations whereas failure of object discernible from the macroscopic perspective is preceded by the evolution of damage at the micro-level.

Therefore, application of non-destructive methods of direct tracing physical change in historic materials, like fracturing intensity at the micro level or delamination of the surface decorative layers, is an important research task. An example of such non-destructive tool for direct tracing the fracturing intensity in cultural objects is monitoring of the acoustic emission (AE) which is defined as energy released due to micro-displacements in a structure undergoing deformation. The energy passes through the material as ultrasound and sound waves, and is typically detected at the surface using a piezoelectric transducer which converts the surface vibration to an electrical signal. AE monitoring has become an important non-destructive tool in material science and engineering, capable of predicting macro damage and tracing crack propagation accurately in space and time due to digital capture and real-time processing of individual AE events. The AE monitoring has recently been successfully applied to diagnosing the cultural wooden objects [2,3]. Several important features have made the AE monitoring a very promising non-destructive tool for indicating the risk of mechanical damage to wooden objects in museums, at historic sites or during their transportation:

1. A frequency signature exists in the AE signals related to damage. The AE events recorded in massive wooden cylinders, imitating sculptures, subjected to damaging climate-induced stress can be divided into two time-frequency bands: one of low frequency between 5–30 kHz and long duration between 500 – 2000  $\mu$ s, and the other of high frequency between 80 – 300 kHz and short duration between 20–450  $\mu$ s. Only low-frequency events were observed when specimens were subjected to non-damaging change in temperature alone or when two pieces of wood were rubbed one against another. In contrast, high-frequency events accounted for between 90–95% of all events recorded when the specimens were subjected to stress leading to wood's damage. The association of the short, high-frequency events with fracturing of the wood structure made possible their extraction from raw AE signals and filtering off all other effects, including the ambient noise.
2. The applicability of the AE technique for tracing the development of damage in authentic wooden works of art in museums or inside historic buildings was confirmed. The frequency pattern of the AE signals for the new and ancient wood proved similar, confirming the applicability of the AE technique for tracing the development of damage in the historic wooden works of art. The on site tests – to monitor the AE activity of the

wooden mediaeval altarpiece in the church of Santa Maria Maddalena in Rocca Pietore, Italy, and the wooden elements of historic organs in the church of St. Andrew the Apostle in Olkusz, Poland - have confirmed that the acoustic signals from routine church activities, such as the organ music or the sounds of bells, can be filtered out (Figure 5).

3. The AE monitoring is capable to trace accurately both single catastrophic events, in response to a sudden high level of stress, and the progressive evolution of damage at the micro-level before any visible, macroscopic failure appears.



Fig. 5. AE sensors coupled to the statue's head during on-site monitoring of the wooden altarpiece.

The technique is capable to follow a broad range of damage intensity. This is illustrated in Figure 6, which shows the dependence of the total energy of the AE signals on the amplitude of the variation in RH produced during heating episodes in a historic church. It is evident that the threshold in the magnitude of the RH variations above which AE activity appears is not a discrete value. The increasing energy of burst events is recorded at increased loading as fracturing occurs in locally weakened areas in wood. The progressive evolution of damage at the micro-level can be traced accurately by the AE analysis.

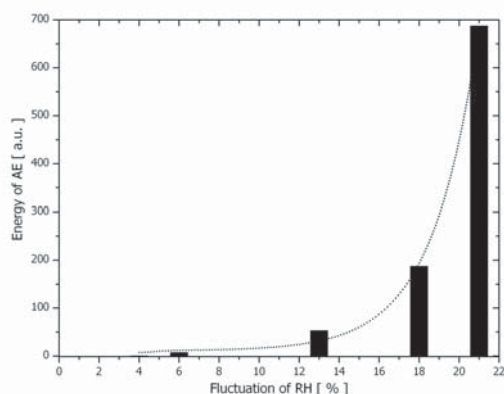

Fig. 6. Total energy of AE events recorded on the wooden altarpiece as a function of the amplitude of the fluctuation in RH.



## 6. Conclusions

The historic climate can provide useful information on the tolerable climatic fluctuations to which wooden works of art susceptible to fracture and deformation have acclimatised. The mathematical processing of past indoor conditions allows defining a clear quantitative target microclimate for preservation. However, investigations of wood response to the climatic variability are an essential support by verifying procedures used to process the historic climate and by defining - if needed - tolerable variations going beyond the historic climate. The direct tracing of damage in objects or standardised object-imitations is particularly promising method to assess the validity of the target microclimates.

## References

1. Jakiela, S., Bratasz, L., Kozłowski, R. (2008): Numerical modelling of moisture movement and related stress field in lime wood subjected to changing climate conditions. *Wood Sci. Tech.* 42: 21-37.
2. Jakiela, S., Bratasz, L., Kozłowski, R. (2007): Acoustic emission for tracing the evolution of damage in wooden objects. *Studies in Conservation*, 52: 101-109.
3. Jakiela, S., Bratasz, L., Kozłowski, R. (2008): Acoustic emission for tracing fracture intensity in lime wood due to climatic variations. *Wood Sci. Tech.* 42: 269-279.

# EXPERIENCES AND PROBLEMS IN PANEL PAINTINGS CONSERVATION

*Marco Ciatti*

OPD – Opificio delle Pietre Dure, Laboratori di Restauro, Florence, Italy  
mciatti@gmail.com

The long tradition of conservation of panel paintings in Tuscany is the result of the frequent use of wooden support from the beginning of the 12<sup>th</sup> century through the second half of the 16<sup>th</sup> century. The need to preserve the panel paintings soon became apparent, for the purpose of maintaining their functionality, primarily for religious reasons, and for the precocious interest of collectors already in the 17<sup>th</sup> century. Protectionist measures were taken at the beginning of this century, on the one side aiming at keeping the most significant parts of the artistic patrimony inside the Granducal territory, on the other side beginning to dedicate attention to the care and maintenance of the artworks already in the collections. Since interest manifested in any specific art form implied attributing noticeable material and artistic value to it, these motivations were sufficient to realize the importance of keeping the art heritage in good condition.

## **1. The first restorers–conservators in Florence**

This tradition gave rise to the work of the so-called Gallery painters–restorers, charged with these responsibilities for the Granducal collections. The most famous of them was Ulisse Forni, author of one of the first restoration manuals in the 19<sup>th</sup> century [Forni, 1866]. In this booklet the operations carried out on wood supports are described, including crack repair, flattening of curved board structures, consolidation of severely damaged areas, and insect disinfestation. Forni also proposes furnishing supports with new moveable battens held by cleats. Even such basic annotations as these will be sufficient to give an idea of how far back in time the Florentine tradition of panel painting restoration may be traced, as I have had occasion to explain elsewhere in more detail [Ciatti, 1999].

## **2. Consolidation of the wooden support: important aspects**

Starting from the 1980s, important improvements in this field took place, still solidly based however on past traditions. The changes resulted from a more complete understanding of the mechanisms behind the behavior of wood, achieved thanks to collaboration with various scientific experts (in particular Luca Uzielli and Marco Fioravanti of the Istituto di Assestamento e Tecnologia Forestale of the University of Florence). Advances followed several lines of thought which have since developed into guiding principles for the work, still considered valid today and constantly subject to optimization. These guidelines or aspects may be briefly summed up as follows: the need for exact measurement of the forces in play throughout the entire lifetime of a wood support; preference for the least invasive methods of intervention, obviously at an equal level of efficiency; the desire to apply more flexible control and support systems to the rear of the panels, having a measurable degree of elasticity which is also and most important possible to regulate over time; finally, close correlation already in the planning stage between the moments of actual intervention and those involving preventive conservation.

## **3. Systems for reinforcement; improvements in the 1980s–1990s**

Efforts have since been made to gradually transform these theoretical assumptions into actual methods of intervention, which have evolved constantly in a series of variations and improvements. Among the first elements to undergo such renewal were the support and control systems attached to the rear of panels, generically called cross-pieces or batten bars. All changes in the techniques of intervention derive from new and different requests based on the theoretical problem solving assumptions related to a project on. These theories are the “forerunner” for any restoration process.

The important requirements may be summed up as follows: permitting horizontal movements of the support on the flat plane; providing an elastic response to control the eventual tendency of the support to bend; assuring the possibility to regulate the elastic response both initially and over time, according to the characteristics of the single panel and the environmental micro-climate.

The first example of a system which united the possibility for the support to increase and diminish its dimensions on the flat plane, while providing an elastic response to curvature, was that applied to the *San Giovanni Gualberto* triptych by Giovanni del Biondo (Florence, Museo di Santa Croce). The operations carried out on this panel, which had been deprived of its original batten system following damage in the 1966 flood, were published in the catalogue of an exhibition of restored works in 1986 [Ciatti and Paolucci, 1986]. Technically, the idea consisted of providing the panel with battens fastened to the support through anchorage points in the form of slots, with strip springs lodged in the thickness of the cross-pieces. From the late 1980s through the decade to follow, various other innovations were developed from this first rudimentary device, definitely improving the initial intuition. One of the systems most often used at the beginning of the 1990s consisted in a strip of nylon (or Teflon) slid into a shaped-to-fit brass housing, to which a screw was connected; the screw was made to pass through a small brass cylinder housing a spring, set into the thickness of the new batten; the mechanism could be regulated by turning a bolt placed on the outer extremity of the screw. Use of this system proved very flexible, quite functional and scarcely invasive, given the limited need for anchorage to the support. It succeeded in many cases to satisfy the works' overall requirements, as well as the specific behaviour of the single boards.

#### **4. New ideas; new support systems.**

An idea arose in certain cases during this period which led to turning over our traditional way of thinking about the role of battens. A change in the traditional relationship between the panel and the batten system was suggested for several cases where the supports had suffered from being thinned down in previous restoration, and had been rendered particularly fragile by a combination of conservation factors. For these panels the original support could no longer be the element expected to carry the weight of the batten system. A framework structure modelled onto the panel would therefore function as the load-bearing element to sustain the weight of the painting. The methods for connecting the parts were based on the sliding/elastic systems previously devised for the attaching battens. Furthermore, the depth of the framework around the perimeter allowed closure of the rear of the panel, thus forming a partially isolated barrier to hygrometric variations.

#### **5. The retreatment of the *Coronation of the Virgin* by Domenico Beccafumi**

An interesting example of application of this method was the *Coronation of the Virgin* by Domenico Beccafumi (originally from the Chiesa di Santo Spirito in Siena, now in the Pinacoteca Nazionale), exhibited in Siena in 1990 in an extensive monographic exhibition dedicated to the artist. The panel painting presented very severe damage both to the painted surface, with blistering and repaints of former losses, and to the support which had suffered from a disastrous episode of past restoration. This situation was combined with the panel's intrinsic fragility derived from the technique of construction: rather than construct a new support of the desired dimensions, the wood craftsman had lengthened a pre-existing one. This was done by half-lap joining another piece of wood, glued to the support with protein-based material which subsequently concentrated most of the wood-boring insect attack in this already very vulnerable area, thus weakening the entire structure. Removal of the three original crosspieces together with their bridge of cleats, and their substitution with a very heavy mechanism screwed and glued down to the panel, had further aggravated its already poor conditions. It was necessary to consolidate the decayed portions of wood by means of impregnation with an acrylic resin, while several particularly devastated portions were substituted by inserting minute pieces of wood similar in type and grain to the original, reinforced with connecting pieces. The numerous cracks were repaired according to the traditional method of fitting small, perfectly crafted wedges of wood into V-shaped tracks opened in the support. This was one of the first occasions of attempting to diminish the inevitable invasiveness of this type of intervention, by reducing the angle of the openings cut into the support. This was accomplished thanks to specially designed and perfected milling cutters, furnished with points made to order by

the manufacturer with an extremely reduced cutting angle. A framework of laminated oak wood replicating the curvature of the deformed support was prepared, and anchored with the above described slide- and spring-system devised for attaching ordinary battens. This framework did not only ensure the usual batten function of warp control, but it also sustained the structure in general, relieving the fragile original panel of the burden of providing mechanical support [Aldrovandi et Al, 1992].

### **5. The retreatment of other panels by Domenico Beccafumi**

Another four small panels by Domenico Beccafumi underwent treatment in the same period. They were originally the head and foot boards, each painted front and back, of a funeral bier used by the Confraternity of the Misericordia of Siena (now in the Pinacoteca Nazionale). Having lost their original function, each of the two panels had been divided in two by cutting through the thickness of the wood, thus forming four little independent paintings. Furthermore, each of the panels had been reinforced by gluing another piece of wood to the rear, attached cross-grain to the original. These events made the presence of biological aggression, cracking, and general decay hardly surprising. Intervention required several innovative solutions, which had to take into account the minute dimensions of the works and the extreme thinness to which they had been reduced. Micro-wedges were inserted, after having obtained a level surface by means of delicate pressure exerted by devices connected to the framework/container. The above-described moveable/elastic system was considered too heavy in this case, and was therefore substituted by a simple wooden element glued in a few points to the support. This new element was fitted with housings containing pins, designed to hold down the support framework under pressure by means of cone-shaped springs. Further elaborations of this method employed oscillating pins, capable of assuring greater freedom of movement in the panel's plane. New frames were constructed taking advantage of the fact that the four little panels had been deprived of their original ones. This permitted the virtual reassembly of the paintings in their original double-face form, and also provided an internal space between the two supports which allowed easy control of relative humidity values [Aldrovandi et Al, 1992].

### **6. Controlling the local environment – a part of the conservation measures**

Just as innovative was the increased attention dedicated to the relationship between solutions chosen for restoration and those relative to successive control of the environment, handling and use. A controlled environment fulfilled the need to address problems connected both with the adhesion of the paint layers and with the condition of the deteriorated support. A kind of box enclosure connected to the frame was made to create a local, improved climate for the panel painting in cases of scarce control of environmental RH and temperature the general. This type of device designed to enclose the sides and rear of the panel, constitutes a system for regulating the exchange of moisture between the wood support and the surrounding atmosphere, thus contributing to stabilizing the support's behaviour. Such provisions have proven to be a vital element for the good conservation of the support itself, and even more so for the painted surface. Moisture exchange may be slowed down more or less according to various provisions determined according to the requirements of the single case in question: protective materials applied to the rear of the panel, environmental stabilizers placed inside the casing fitted to the back of the painting (for ex. pre-conditioned ArtSorb). These practices have been applied since then, not only to those cases considered most critical, such as the truly dramatic examples of flood damaged panel paintings, but also to other works still in relatively decent condition.; These closed systems have proven to be quite simple to make, and especially useful for flood damaged works, which might otherwise have been destined to the extreme treatment consisting in colour transfer, see Ciatti et al. [2006].

The application of protective enclosures to the rear of paintings has also been extended to works on canvas, obviously using different materials. One of the first examples of actual application of this sort of system was on the *Coronation of the Virgin* by Botticelli from the Uffizi. This panel, suffering from paint blistering which normal consolidation treatments had been unable to solve, had not been exhibited in more than fifty years. Very careful consolidation measures were undertaken, including the use of vacuum pressure, combined with the previously mentioned system of protection of the

rear., at the time using pre-conditioned silica gel. This allowed the panel to be put back in the Gallery in 1990 [Ciatti, 1990]. Since then many paintings have been treated positively in this way, thus avoiding the need to use invasive operations which may alter the very nature of the works of art.

Fundamental to the work was is was the idea of linking the restoration intervention and the preventive conservation measures. More of the discussion on the methods and a more detailed explanation of the technical aspects connected with the conservation of wood supports may be found in the volume edited by O.P.D., specifically dedicated to this important theme and fortunately also published in English: M. Ciatti, C. Castelli, A. Santacesaria (eds.), 1999-2006 – *Dipinti su tavola: la tecnica e la conservazione dei supporti*, Firenze 1999, and *Panel Painting. Technique and Conservation of Wood Supports – Revised English Edition*, Firenze, 2006.

## 7. The conservators request to of Wood Science

Finally, in response to one of the themes proposed for this international congress, “what may we ask of Wood Science”, I wish to emphasize in the name of those who are engaged in the conservation of wood supported artworks, how important and urgent it is to find new answers to several questions decisive for even thinking that our work are really based on at least some certainty.

First of all there is a need to gather more information on the behaviour of the support. The study of the behaviour of supports must proceed. This is a complicated task, caused by the difficulty of creating representative models which are able to cover the infinite existent variables. This study could be a way to attempt gathering a complete range of “case stories” or “ case samples” of measurements.

Then, it would be good , to document and measure the behaviour and movements of an actual case study, using simple, non-invasive instruments which permit measurements both on the flat plane and in the three dimensions.

The third and final point regards the materials necessary for consolidation of the wooden supports, an area in which true innovations have not been introduced for many, perhaps too many years. In the lack of other suggestions and despite great perplexities, the usual acrylic resins continue to be employed: here times seem really ripe for some new and interesting proposals.

## References

1. Forni U. (1866): “Manuale del pittore restauratore”. Firenze. Note: this booklet had never been republished until 2004: G. Bonsanti and M. Ciatti (Editors) (2004): “Ulisse Forni, Manuale del pittore restauratore. Studi per una nuova edizione”. Firenze.
2. Ciatti M. (1999): *Dipinti su tavola: riflessioni sulla storia della produzione e della conservazione dei supporti*. In: M. Ciatti, C. Castelli, A. Santacesaria (Editors) “*Dipinti su tavola: la tecnica e la conservazione dei supporti*”. EDIFIR, Firenze, pp. 11-28.
3. Ciatti M., Paolucci A. (1986): *Immagine e materia: due aspetti del restauro nei dipinti su tavola*. In: “*Capolavori e restauri*” Catalogue of the exhibition. Firenze, pp.391-468.
4. Aldrovandi A., Bracci N., Bracco P., Castelli C., Ciappi O., Ciatti M., Parri M., Ramat A., Santacesaria A. (1992): *Ricerche e interventi su alcuni dipinti di Domenico Beccafumi*. In: “*O.P.D.Restauro*”, n.s., 4, pp.28-50.
5. Ciatti M., Frosinini C., Rossi Scanzanella C. (Editors) (2006): “*Angeli, santi e demoni: otto capolavori restaurati. Santa Croce quaranta anni dopo (1966-2006)*”. Firenze.
6. Ciatti M. (Editor) (1990): “*L’Incoronazione della Vergine del Botticelli: restauro e ricerche*”. Firenze.
7. Ciatti M., Castelli C., Santacesaria A. (Editors) (1999-2006): “*Dipinti su tavola: la tecnica e la conservazione dei supporti (1999)*”, and “*Panel Paintings. Technique and Conservation of Wood Supports (Revised English Edition, 2006)*”. EDIFIR, Firenze.

# NEEDS FOR CONSERVATION OF PAINTINGS ON ENGINEERED WOOD SUPPORTS

*Elżbieta Jeżewska*

Faculty of Conservation and Restoration of Works of Art, Warsaw Academy of Fine Arts, Poland  
ejez@interia.pl

## **Abstract**

As engineered wood appeared on the world markets, it soon became a cheap alternative to other painting supports such as canvas and wooden boards. Painters used engineered wood like plywood, fiberboards and particleboards with or without priming it with a ground layer. Engineered wood is still being used today for that purpose and even to the greater extent because of increasing range of ready to paint boards, so called canvas boards. By now the boards have been in use long enough to show what kind of damages may develop by use and with age, and it's about time to take care of them.

## **1. Introduction**

Engineered wood, also called wood-based (e.g. panels), includes a range of derivative wood products which are manufactured by binding together wood strands, particles, fibers, or veneers with adhesives to form composite materials. The objective of producing such products is to make a product with the similar advantages as wood, and at the same time free of the wood's disadvantages. As engineered wood appeared on the world markets it soon became a cheap alternative to other painting supports such as canvas and wooden boards. Engineered wood was especially a good alternative to wood, which with the invention of canvas slowly started to vanish from the painting market. At some point, artists realized that canvas was a desirable and practical replacement for wood panels, which needed greater amount of preparations before use. When wood based panels appeared, its similarity to wood and at the same time its superiority to wood was noticed. Painters used plywood (at first bonded with natural adhesives), fiberboards and particleboards with or without priming it with a ground layer. The most important advantage of the boards has been that this kind of support can be much thinner and much lighter than wood. Engineered wood is still being used today for that purpose and even to a greater extent because of the increasing range of ready to paint boards, so called canvas boards. Since engineered wood is a relatively young product; its processes of aging have not been studied. The study of the aging is complicated since many factors have to be taken into consideration; used adhesive being the most important.

## **2. Plywood**

Plywood was invented in the 1850s as a combination of three or more layers of thin sheets of wood. Layers or veneers of wood are plied together with the grain running crosswise. This balanced construction of a plywood panel tends to equalize stress, thus reducing shrinkage, swelling and warping. Crossing the adjacent sheets tends to equalize the strength and stresses in all directions. Due to the crossed laminations plywood can be nailed or screwed near the edges without the risk of splitting. Availability of relatively large sizes is an obvious advantage. It is wide known that plywood idea is ancient; archaeologists have found traces of laminated wood in the tombs of the Egyptian pharaohs. Egyptians invented veneer as wood, especially wood of good quality and with an aesthetic value, was a scarce material. Logs were sawn into very thin boards and glued to less valuable wood or wood of a lower quality.

In the 1840s Michael Thonet, a cabinet maker from Boppard-am-Rhein in northern Germany was applying the technique in making steam-bent plywood chairs with great success. But already before his work was exhibited at the Crystal Palace in London in 1851, plywood was beginning to be commercially produced for artists [4].

Plywood became easily attainable at the beginning of 20th century all over the world. But the beginning of plywood production varies with the countries. The earliest known painting on plywood support in literature is dated around 1880 [4] This is the painting "Albano, Italy" by George Inness in The Art Museum, Princeton University in USA. The label on the backside of the panel shows the support came from the commercial production of so called Artist Boards.

Although the practice of gluing sheets of thin veneers cross grain to a thicker board had a fairly long history, as for example observed in the decorative examples in fine furniture of among others Thonet in the 18th century, obtaining wide sheets of veneer was not possible until the development of veneer slicers around 1875 [4].

In Poland plywood support is rarely found to be dated before 1900. The reason for this may be that when plywood was “hand-made” for furniture application it must have been more expensive than a simple wooden support. The plywood support was probably not cheap and not in wide use until it became a massproduced commercial product<sup>1</sup>.

Most common damages occurring in plywood supports are:

1. **Delamination:** A partial or total detachment of the sheets in the plywood. Possible causes are: improper storing conditions and biological attack. Until the invention of synthetic resin in the early 1930s, natural adhesives were used. Their attractiveness for living organisms is already well known. It was proved that synthetic resins used nowadays for engineered wood products have minimal or no resistance to fungi [1]. Urea-formaldehyde resin bonded panels of all types appears to be more attractive for microorganisms than phenol-formaldehyde resin. For the preservation, storing conditions are of great importance especially when adhesives which are not waterproof, as urea-formaldehyde, have been used in the plywood. But also the so called “exterior application plywood products”, which are made with waterproof adhesives like phenol-formaldehyde, should be kept in conditions suitable for wood. Wood is for both kinds of plywood the dominant material and responds to humidity and temperature changes.
2. **Corner damages:** They occur frequently in connection with delamination. Delamination reduces the rigidness of the support’s edges. It happens even more readily with increasing size and weight of the supports. Artists did not always use good quality supports, e.g. produced with more layers of wood, when they wanted to paint a picture of some size. Before the Second World War they rarely used more than three layers plywood. The reason might be quite simple and similar to the reason why artists chose plywood at all – economy. A three-ply plywood is cheaper than a five- or seven-ply product. Also the type of adhesive used for the fabrication makes a difference in price. Waterproof products, which would be a natural choice for a bigsize support, are much more expensive than those intended for indoor use.
3. **Warps, twists and shape distortions:** These damages are caused by the production process of plywood. Most of nowadays produced veneers for plywood production, are rotary cut, that is peeled from around the wooden log. Shrinkage and swelling of wood which responds in that way to humidity changes, causes internal stresses in the veneer which tries to achieve the shape it had on the log before it was peeled.
4. **Insect attack.** Despite presence of synthetic adhesives, plywood is attractive for wood boring insects. And flight holes might appear also on the painting’s front side.
5. **Extensive cracking of paint layer following the pattern of the damages of the support’s surface.** When face veneer responds to humidity changes it might crack parallel to grains as wooden support would do. But in the case of plywood the wood layer is very thin and the process of water sorption and desorption is quicker, and at the same time the surface veneer movements are restrained both by the glue layer and the nearest layer of wood in the plywood.

### 3. Fiberboard

Fiberboards today are divided into two groups according to the process of production (PN-EN 316:2001):

1. produced with “wet” method. Fibers are suspended in water which is then poured out on a screen to form a sheet. These are: hardboards (HB), medium boards (MB) and softboards (insulation boards) SB.

---

<sup>1</sup> First plant started production of plywood in 1886 in Pińsk, at that time within borders of so called Kingdom of Poland, created on the part of Polish territory under the Russian czar’s rule (Pachelska 2003).

2. produced with “dry” method. The sheet or mat is formed by suspending fine fibers in the air and depositing them on an underlying moving screen. These are: low density boards (LDF), medium density boards (MDF) and high density boards (HDF).

All these panels are made of lignocellulose fibers. Raw materials for fiberboard production are: small and medium-size wood (e.g. pulpwood), wood wastes (e.g. edgings) and annual plant derived material (mostly straw). In the first phase these materials are chipped and the chips are washed. Then they are disintegrated into fibers and fiber bundles. Wooden chips are defibrated with the Asplund’s method or the Mason’s method. The beginning of fiberboard industrial production starts with Mason’s patent. In the 1920s he was experimenting with the process of converting wood chips and edgings into fiber without loss of lignin, which resulted in his first patent, obtained in 1926. In the process he invented, wood chips are subjected to high steam pressure in a digester. The steam softens the lignin and helps to fiberize the wood chips. The digester was used in a two stage process in order to reach high temperature of maximum 280°C in 50-100 seconds. When the pressure suddenly is released to atmospheric level, the fibers explode and are forced out of the pressure chamber through an outlet valve of comparatively small dimension constructed to cause further disintegration of the fibres.

In 1926 the first hardboard fabrication of this new type of hardboard [2] was established by the Mason Fiber Company, later called the Masonite Corporation, in Laurel, Mississippi.

In Europe, the method based on the Swede Arne Asplund’s defibrator, patented in 1931, became more popular. In this method wood is subjected to thermo-mechanical pulping. In order to soften the lignin, wood is heated with steam to 175-193°C for 2- 4 minutes and mechanically disintegrated into fibers by grinding it in specially formed grinding discs for 2-4 minutes and at 175-193°C [7].

Boards produced with the “dry” method were invented in the last decades of the 20<sup>th</sup> century, much later than “wet” process boards. Among the latter ones, conservators are mostly interested in hardboards as artists have used these panels in the 20th century for painting supports more frequently than other types of fiberboards.

“Hardboard,” as defined by the PN-EN 316:2001, is a panel manufactured primarily of lignocellulose fibers consolidated under heat and pressure to a density of at least 900 kg/m<sup>3</sup> with a nominal thickness of 1,5 mm and higher. The temperature of 200-220°C used when hot pressing the panel and pressure of maximum 5,5MPa results in creating new hydrogen bonds between wood fibers and in hardening the phenol-formaldehyde resin used to bind the fibres. This is a thermo-hardening resin unlike urea-formaldehyde resin. The softened lignin acts as an additional natural bonding in the panel in the hot pressing process. Hardboard should not be confused with particle board, which has much rougher surface as it is made of wood particles of greater size.

Artists soon realized that hardboard as a material possesses good characteristics: the boards are homogeneous, have no defined grain direction as wood panels have, and they have the advantage of not swelling or shrinking like wood. And again, as for plywood, they have a good size to weight ratio.

Typical problems connected with all types of fiberboards are the following [12]:

1. Big sized panels tend to warp and twist when not cradled. Due to the fabrication method, which is the hot pressing, hardboards are smooth on one side (this is described with a symbol: S1S) and have an imprinted fine mesh pattern on the reverse. These two surfaces have different humidity sorption characteristics and warping may occur.
2. Corners tend to compress. The denser the panel the less severe is the problem.
3. Priming fails to adhere to the smooth side of the board. This is probably also due to the manufacturing process. Paraffin emulsion as a hydrophobic agent is added during the production and remains on the surface. On some hardboards a layer of drying oil is applied to the surface in the production process<sup>2</sup>. The plates of the press might also be covered with anti-adhesive agents, which may leave a residue on the surface of the boards. The consequence of this poor adherence of priming is very quick flaking of painting layers.
4. Phenolic and amine resins. These resins are a reason for the formaldehyde out-gassing. Wet

<sup>2</sup> Common procedure in the past. Now of lesser importance and rarely used.



process boards like hardboards, release much less of this gas since they have a smaller amount of glue<sup>3</sup> and are bonded with phenolic resins which are much more durable against hydrolysis. However, in amine resin bonded panels it is a greater problem and it must be tested during production (formaldehyde emission classes)<sup>4</sup>. This is a potential problem, certainly for chemical-sensitive painting materials. There are no studies looking at the aging characteristics of these resins in the context of painting supports, and no studies looking at its compatibility with standard painting practices and materials. The resins and many other new glues, like the isocyanates, are in this connection, simply unknown materials and we can not predict how they will influence the natural aging of the paintings.

5. Though phenolic resins are thermally set, amine resins occurring in some panels need acid hardeners. They are usually acid salts. Until recently ammonium chloride ( $\text{NH}_4\text{Cl}$ ) has been used. Lately, for ecological reasons, it was replaced with ammonium nitrate ( $\text{NH}_4\text{NO}_3$ ) or sulphate ( $(\text{NH}_4)_2\text{SO}_4$ ). During hot pressing these hardeners break into ammonia (evaporating quickly) and appropriate mineral acid. Although the amount of this acid is comparatively small, it stays in a panel and may provoke slow wood hydrolysis. The effect of this action for painting layers has not yet been studied.
6. Lack of ground layer may influence quicker aging of the paint layer. Artists learnt quickly that painting directly on canvas with oil paint, increased the rate of disintegration of the support's fibers due to the acidic action of drying oils. It seems logical to assume that the surface of fiberboards will react in a similar way. The problem might even be doubled if the hardboard had been tempered with drying oils.

## Conclusions

Identifying the reasons for damages in works of art painted on engineered wood and finding correlation between the damages and the technology used to produce the engineered wood panel should be an objective for further studies with the aim of :

- a) determining proper storing conditions for the works of art painted on these supports,
- b) detecting the consequences of the degradation or aging of the new composite materials being used in conservation today; obtaining knowledge about the chemical compatibility of conservation materials and particular components of engineered wood supports produced with historical technology.
- c) understanding more of the chemical characteristics and technical parameters of wood composite panels produced today and used as paintings supports; and specifying the best methods for their anti-aging.

With the increasing application of wood-based composites, there will continually be more of such material used as supports for paintings. Present-day artists more often discard traditional ways of preparing a support, and choose an easily attainable substitution like engineered wood.

Future studies should include analysis of painting materials and technique used for the paintings painted on engineered wood. Determining the way engineered wood is aging is also of importance. The aging characteristics of the particular adhesives used in engineered wood is important when it comes to determining the extent to which the engineered wooden board differs from wooden panels when used as a painting support. Without better knowledge of the engineered wood it is hard to estimate the future consequences for paintings on boards which are consolidated with the use of modern, synthetic materials.

---

<sup>3</sup> Hardboards presents much smaller amount of glue (1%) than amine resin bonded panels (8-12%, based on the absolutely dry wood fiber mass) like MDF or particle boards.

<sup>4</sup> EN 120:1992 Wood based panels. Determination of formaldehyde content. Extraction method called the perforator method.

**References**

1. Fojutowski A., Kropacz A., Ważny J. (2007): Odporność sklejkki sosnowej na działanie grzybów atakujących drewno, [w:] Ochrona drewna. XXIII Sympozjum, Rogów 5-7 września 2007 r, Warszawa , p. 103-112.
2. Katlan A.W. (1994): Short communication early wood-fiber panels: masonite, hardboard, and lower-density boards, *Journal of the American Institute for Conservation*, vol. 33, no. 3, article 5, p. 301-306. <http://aic.stanford.edu/jaic/articles/jaic33-03-005.html>
3. Kreisberg J. (1956): Geneza ekonomiczna rozwoju przemysłu sklejkowego, *Przemysł Drzewny* 7, p.16-19.
4. Muller N.E. (1992): An early example of a plywood support for painting, *Journal of the American Institute for Conservation*, vol. 31, no. 2, article 8, p. 257-260.
5. <http://aic.stanford.edu/jaic/articles/jaic31-02-008.html>
6. Myers G.C., McNatt J.D. (1985): Fiberboard and hardboard research in Forest Products Laboratory. A 5-year summary, Forest Products Laboratory, Madison, General technical report FPL 47.
8. Oniśko W., Hikiert M.A. (2006): Wood-based panel industry in Poland – yesterday, today and tomorrow, *Annals of Warsaw Agricultural University. Forestry and Wood Technology* 59, p. 137-146.
9. Oniśko W., (1978): “Technologia płyt pilśniowych”, SGGW-AR, Warszawa.
10. Pachelska H. (2003): Początki przemysłu sklejkowego w Polsce, *Biuletyn Informacyjny Ośrodka Badawczo-Rozwojowego Przemysłu Płyt Drewnopochodnych w Czarnej Wodzie*, 3-4, p. 181-188.
11. Pachelska H. (2003): Przemiany techniczne i technologiczne w przemyśle drzewnym na ziemiach polskich w latach 1870-1939, Wydawnictwo SGGW – Warszawa.
12. Prystupa H. (2004): Historyczno-organizacyjny rozwój przemysłu płyt, sklejek i zapalek w Polsce, *Ośrodek Badawczo-Rozwojowy Przemysłu Płyt Drewnopochodnych w Czarnej Wodzie*.
13. Tétreault J. (1993): Guidelines for Selecting Materials for Exhibit, Storage and Transportation, Canadian Conservation Institute  
<[http://www.cci-icc.gc.ca/publications/cidb/viewdocument\\_e.aspx?template=print&Document\\_ID=82](http://www.cci-icc.gc.ca/publications/cidb/viewdocument_e.aspx?template=print&Document_ID=82)>.
14. Thomson E. (2003): Which hardboard is the best.  
<[http://www.true-gessopanel.com/2003\\_stp\\_article.htm](http://www.true-gessopanel.com/2003_stp_article.htm)>.

**Standards:**

1. EN 120:1992 Wood based panels. Determination of formaldehyde content. Extraction method called the perforator method.
2. PN-EN 316:2001 Płyty pilśniowe. Definicja, klasyfikacja i symbole.
3. PN-EN 622-2:2006/AC:2006 Płyty pilśniowe – Wymagania techniczne – Część 2: Wymagania dla płyt pilśniowych twardych.
4. PN-EN 622-5:2007 Płyty pilśniowe. Wymagania techniczne. Część 5: Wymagania dla płyt formowanych na sucho (MDF).

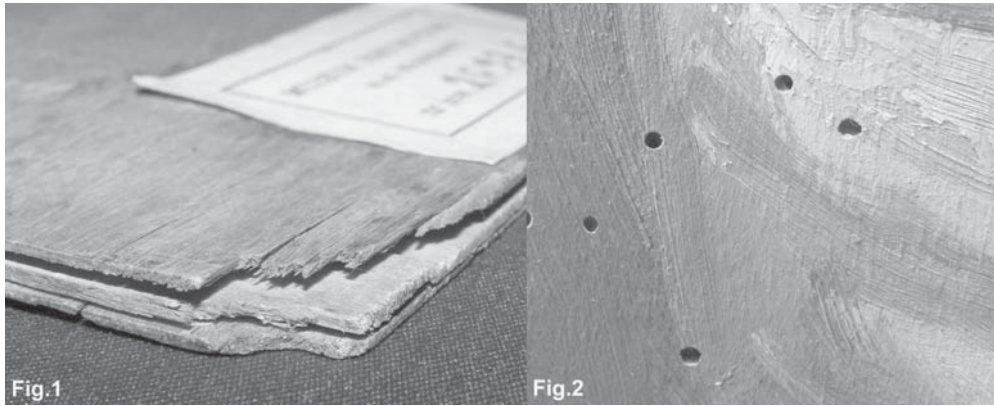

Fig.1

Fig.2

Fig. 1 Delamination and corner damages of plywood support (phot. E. Jeżewska).  
Fig. 2 Flight holes on the paint layer side of the plywood support painting (phot. E. Jeżewska).

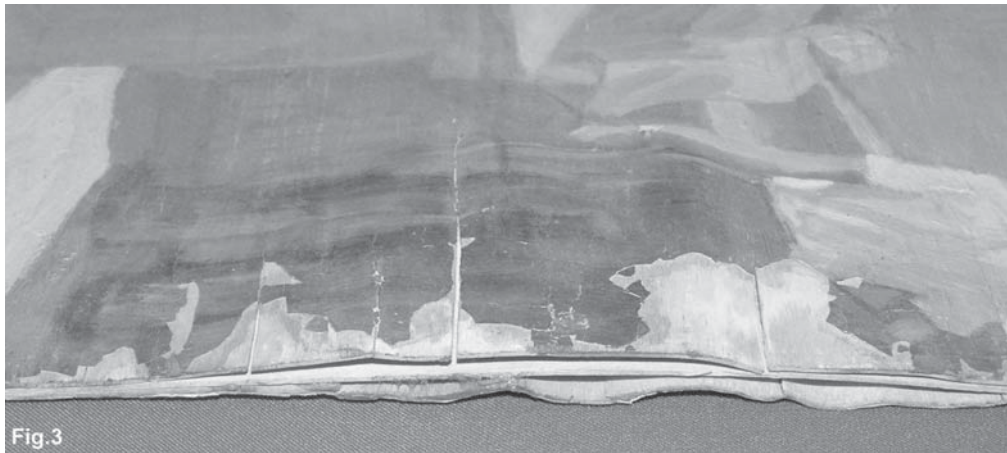

Fig.3

Fig. 3 Shape distortion of plywood support. After being flooded the painting remained in water for some time (phot. E. Jeżewska).

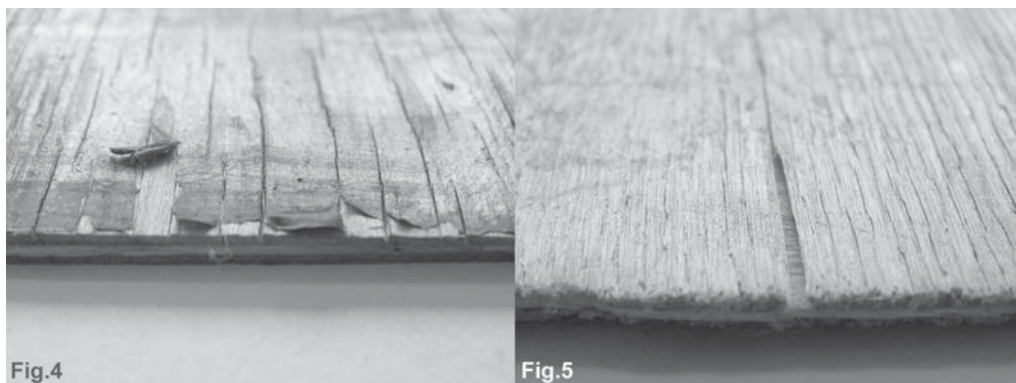

Fig.4

Fig.5

Fig. 4 Paint layer on plywood support showing extensive cracking parallel to grains of the nearest veneer (phot. E. Jeżewska).  
Fig. 5 Cracking parallel to grains of the backside veneer of the same painting (phot. E. Jeżewska).



Fig. 6 Wall paintings from the Church of Santissima Anunziata (Florence) transferred on canvas which was then glued to fiberboard panels. Panels have been hung in the church mentioned above and show damages typical for big sized fiberboards (phot. E. Jeżewska). Figure 6 shows shape distortions probably due to humidity condensation in the space between wall and the panels.  
Fig. 7 Close-up of one of the panels. Loss of cohesion of the panel can be observed (phot. E. Jeżewska).

# MICROCLIMATE IN THE MALBORK CASTLE, POLAND: SELECTION OF HEATING STRATEGY TO PRESERVE WOODEN OBJECTS

*Jolanta Ratuszna*

Conservation Department, Malbork Castle Museum, Malbork, Poland  
jollunia@poczta.onet.pl

## **Abstract**

The Malbork Castle is a vast fortified monastery built in the thirteenth century as the main seat of power of the Teutonic Order, a chief executant of the Crusades in Eastern Europe. The Castle has been inscribed into UNESCO World Heritage List in 1997 as a unique creation of Gothic European architecture. Microclimate conditions (temperature T/ relative humidity RH) were monitored for more than one year in the western wing of the complex comprising the important Palace of the Grand Masters and the Great Refectory. Impact of several heating strategies on microclimatic conditions was simulated. The available information and still open questions are briefly presented.

## **1. Introduction**

The Castle of the Teutonic Order in Malbork covers an area of over twenty hectares and consists of the three castles joined together by a system of extensive fortifications. In this impressive edifice The Castle Museum has its seat since 1961. The main tasks of the Museum is both the care for the castle architecture and artworks collections presented in historic rooms open to the public during the whole year. The Museum collects artefacts made of sensitive organic materials, like furniture, panel paintings, wooden painted sculptures, etc. Thus the main problem of the preservation of artworks is maintaining the appropriate microclimate.

For almost two years the professional environmental records from the most precious western wing of the complex contribute to the understanding of climate within the rooms. Other few rooms are equipped with the computerized control system used to control conservation heating. Many parts of the castle are still not available for touring, but they are potential places for new displays. Invention and adaptation of the optimum strategy leading to stabilization of microclimate in current and future exhibitions should be the essential part of preventive conservation practice.

## **2. Optimum strategy?**

The interiors of the Grand Masters Palace and the Great Refectory had no heating and their 'natural' climate was measured during more than one year period. This climate, typical of many unheated mediaeval buildings of northern Europe, features (see Figure 1):

- *high average relative humidity of 65%, with marked medium- and short-term fluctuations (which are periodically between 50% and 85%),*
- *and a seasonal variation of temperature from below 0°C in winter to 25°C in summer.*

The specialists from the National Trust say, that “there is still not enough evidence to say exactly how much fluctuation in RH a collection with organic material can withstand. (...) Some museums specify that RH fluctuation should be less than 10 per cent in any 24-hour period. However, in a historic house this level of stability can be difficult to achieve without an excess of inappropriate technology, it may even be unnecessary. Most objects respond slowly to a change in RH, and a dip for less than six hours – for example, if a room is heated for an event during the winter – is unlikely to affect their moisture content adversely. In National Trust houses, ‘good’ RH control is considered to be when the RH is within the target band for more than 90 per cent of the time”<sup>1</sup>.

Museums have also strict requirements for T level and the fluctuations in T: they say it should be

---

<sup>1</sup> Staniforth S. (2006): “Relative humidity as an agent of deterioration”, The National Trust Manual of Housekeeping. The care of collections in historic houses open to the public Elsevier Butterworth-Heinemann, Oxford, 106.

stable at 18–20°C, but well, the restrictions were not based on researches and are not practical. However, many objects, excluding those that contain materials with high coefficients of thermal expansion and contraction, are not much affected by temperature but suffer a great deal from RH variations due to warm air, which tends to rise and lower RH. It is considered that the wrong RH is that which is either too low or too high, or fluctuates too much.

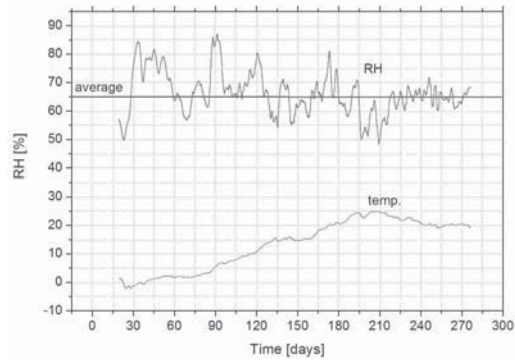

Fig. 1. The data of the 'natural climate' (2006/2007).

Taking into consideration the above knowledge, the simulations of a few strategies were worked out:

*Conservation heating*, which concentrates on the indoor climate for preservation, principally by stabilizing the RH indoors at a favourable level throughout the entire year. The level of 60 per cent of RH was suggested. Little thermal comfort to staff is possible in winter (see Figure 2):

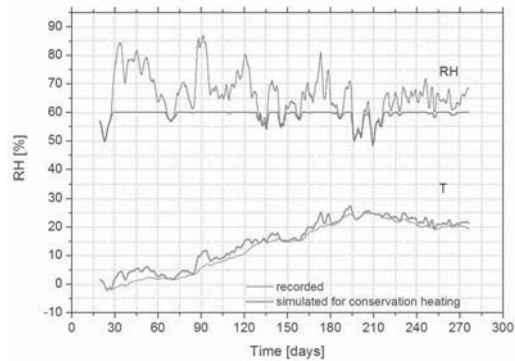

Fig. 2. Simulation strategy - the changes in RH and T after providing some heat in the humid periods, in winter the T would be possibly low even under 0°C.

In a medium-cold climate in Malbork, thermal comfort for people and preservation represent conflicting needs. Reducing the heat supply in the coldest periods is beneficial to preservation and may require some sacrifice to people. The problem is that staff work eight hours a day and would not be able to stand such low temperatures.

Other solutions to consider would be:

*Heating at a constant temperature* - a certain thermal comfort to people but causes very low levels of RH during cold periods (see Figure 3):

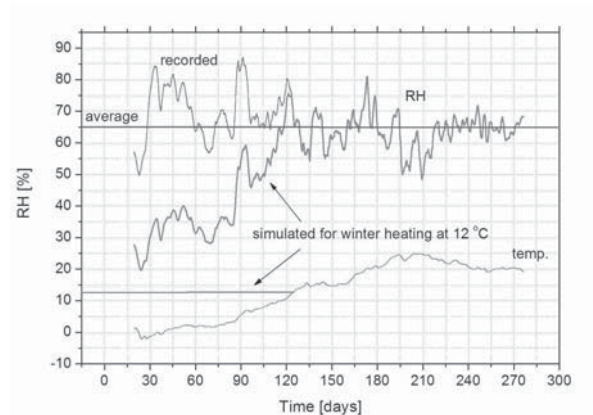

Fig. 3. Simulation strategy – very low RH during long periods – about 90 days or more, whilst the comfort of 12°C may be for people still too low.

For improving RH level in winter, the *Background heating* was simulated: constant heat input of 6°C more than without heating, improves thermal comfort on the level of a few degrees, and a fall of RH in winter is reduced. (see Figure 4):

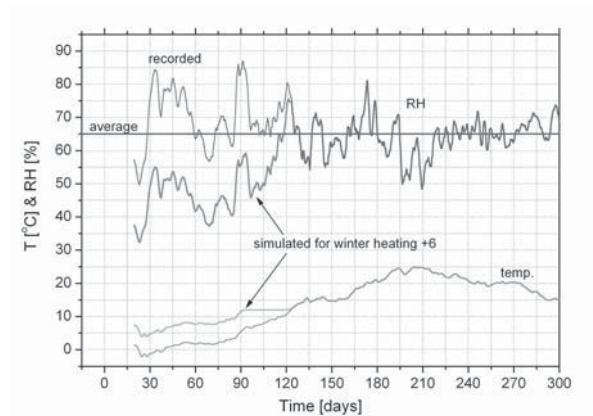

Fig. 4. Simulation strategy – Background heating – the low T in winter, the air could be sometimes too dry, under 50–40% of RH.

In some of the mentioned interiors of the castle the heating system was put into operation and the target band of 50–65 % RH in summer and 45–55% in winter was established. This modification in winter is a proposal due to staff working inside, but still we do not know what the real risk sensitive wooden objects is. This conservation heating is controlled using humidistats, which switch the heating convectors on when the RH goes above a set point and off when it falls below. Despite the improvement in winter 2007/2008 there were short-term periods of too low RH whilst the thermal comfort was insufficient.

### 3. Conclusion

People who care for wooden objects in museums have to be aware of the risk to which every type of artwork is exposed during RH fluctuations. The question is, what level and fluctuation of RH is safe to the sensitive wooden artworks. In historic buildings, like the Malbork Castle open during the whole year, the optimum solution is a matter of a compromise between thermal comfort for

people and the preservation of artworks. Though various climatic specifications for museums are available in the conservation literature, wood experts should clear recommendations on the tolerable climatic variations in historic buildings in which climate control is limited.

## References

1. Camuffo D., Pagan E., Schellen H., Limpens-Neilen D., Kozłowski R., Bratasz Ł., Rissanen S., Van Grieken R., Spolnik Z., Bencs L., Zajączkowska-Kłoda J., Kłoda P., Kozarzewski M., Podogrodzki M., Santi G., Chmielewski K., Jute T., Haugen A., Olstad T., Mohanu D., Skingley B., Sáiz-Jiménez C. (2006): "Church Heating and the Preservation of the Cultural Heritage. Guide to the Analysis of the Pros and Cons of Various Heating Systems", (ed. D. Camuffo), Electa, Milano.
2. Shelley, M. (2000): "The care and handling of Art Objects in the Metropolitan Museum of Art", The Metropolitan Museum of Art, Yale University Press, New York.
3. Staniforth S. (2006): "Relative humidity as an agent of deterioration", The National Trust Manual of Housekeeping. The care of collections in historic houses open to the public Elsevier Butterworth-Heinemann, Oxford, 103-113.



# COLOUR TESTS FOR IRRADIATED PAINTED WOODEN PANELS

*Constantin-Daniel Negut<sup>1</sup>, Corneliu Catalin Ponta<sup>1</sup>, Rodica Maria Georgescu<sup>1</sup>,  
Olimpia-Hinamatsuri Barbu<sup>2</sup>*

<sup>1</sup> Irasm Dept., Horia Hulubei National Institute of R&D for Physics and Nuclear Engineering,  
Romania

<sup>2</sup> Conservation-Restoration Dept., National University of Arts Bucharest, Romania  
dnegut@nipne.ro

## Abstract

Insects and micro-organisms are frequently identified enemies of cultural objects. Based on its biocide effect, gamma irradiation can be used for decontamination. The most important advantages of this method are: no toxic or radioactive residues remained in the treated item; large amount of objects treated quickly; excellent reliability. Interaction of gamma rays with any substance may change its chemical and physical properties. In the case of paintings, eventually colour changes have to be evaluated. Such an approach actually establishes irradiation treatment limitations. Results of colour analysis before and after the irradiation of painted wooden panels are discussed.

## 1. Introduction

Cultural heritage objects are often made of a combination of organic and inorganic materials. Biotransformation process plays a major role in their degradation. The most important species involved in biodegradation are fungi and insects. Based on its biocide effect, gamma radiation could be used for decontamination and conservation purposes.

Important advantages of gamma radiation treatment:

- no toxic or radioactive residues remained in the treated item
- large amount of objects can be treated quickly
- excellent reliability
- attractive cost

One may use well-established safety doses or perform supplementary tests. It is known that an absorbed dose of 500 Gy is enough to kill larvae and to prevent the emergence of adult insects. At 10 kGy fungi are eradicated. In practice, the absorbed dose used in decontamination is ranging in the interval 0.5 – 5 kGy.

In the same time, the interaction of gamma rays with substance may change its chemical and physical properties. In the case of paintings, eventually colour changes have to be evaluated. Such an approach actually establishes irradiation treatment limitations. Perception of colour is subjective. Colour measuring instruments provide an objective, numerical measurement system and discriminate small colour differences better than the average human observer. To quantify the effect of gamma irradiation on the colour of wooden paintings colorimetric analysis were performed using a spectrophotometer.

## 2. Objective

The aim of this paper is to present and discuss some results concerning influence of gamma irradiation process on the colour of painted wooden panels. A large part of these results was published in detail elsewhere [1].

## 3. Materials and methods

### 3.1. Materials

A multilayer structure is observed in traditional paintings on wooden panels, Fig. 1. The chemical composition of these layers varies with the painting technique, the kind of painting materials used,

the historical period, and the artist.



Fig. 1. Multilayer structure of wooden painting.

The effect of gamma irradiation on the colour of samples simulating ground layers and wooden painting was analyzed. Also, the chalk used in the preparation of ground layers and pigments in powdered form were tested.

### 3.2 Methods

Irradiation was carried out in the presence of air at room temperature. A SVST Co-60/B gamma irradiator was used. Absorbed dose was measured with an ECB dosimeter system using oscillometry method.

Colour measurements were performed with a portable spectrophotometer (reflectance spectroscopy) MiniScan XE Plus (HunterLab) in  $d/8^\circ$  geometry, specular component included, D65 illuminant, and  $10^\circ$  standard observer.

### 4. Results

Some of the pigments in powdered form irradiated at two different doses (11 and 36 kGy) showed significant colour changes after irradiation. However, the colour shift is mainly due to an increase in lightness and chroma, and one can suppose a change in the amount of water contained in pigments. Samples simulating wooden paintings were prepared in tempera technique using those pigments which showed a significant colour shift after irradiation. Half of them were additionally varnished. All of them were tested after irradiation at 11 kGy using two different dose ratios: 35 and 245 Gy/min. Only samples containing chrome yellow have had a significant colour shift; they became darker, greener and less yellow after irradiation. The total colour difference increased with dose ratio. Varnished samples had a lower colour shift than unvarnished ones that suggests an oxidation process in the pigment as the main reason for colour change.

Ground layers irradiated at 11 and 36 kGy showed a strong colour shift after irradiation: darker, greener and bluer in comparison with their references. Corresponding total colour difference decreased in time and after about 30 days the colour of samples simulating ground layers stabilized. However, after stabilization, colour changes were still visible, in the range of 6 to 16  $DE^*$  units.

Samples of chalk used in the preparation of ground layers were irradiated. Colour shifts of irradiated chalk are comparable, in terms of total colour difference, with those obtained for ground layers, but the source is different because the chalk became redder after irradiation ( $a^*$  value increased). Calcium carbonate of high purity was also irradiated, but only at 20 kGy, and its colour shift evaluated. In Fig. 2 are presented reflectance spectra for the chalk used in the preparation of ground layers and calcium carbonate. One can see that the shape of the reflectance spectrum corresponding to calcium carbonate irradiated at 20 kGy is very close to its unirradiated reference, so no significant colour shift. In terms of CIELAB, irradiated calcium carbonate showed just a little decrease in  $L^*$  value. The strong colour shift of irradiated chalk can be related to formation of colour centres

during gamma irradiation, absorption of visible light being caused by electrons/hols trapped in the defects of crystals.

Formation of colour centres was observed after proton irradiation of carbonate based natural painting pigments and ceramics for PIXE measurements [3, 4, and 5]. Stains observed on proton irradiated artefacts progressively faded out after irradiation. Heating and UV accelerate the fading of the stains. It is known that heating or UV irradiation destroy colour centres, so these observations confirm the supposition that formation of colour centres is induced by proton (and, also, gamma) irradiation. However, heating cannot be an option to remove colour centres created in ground layers during irradiation.

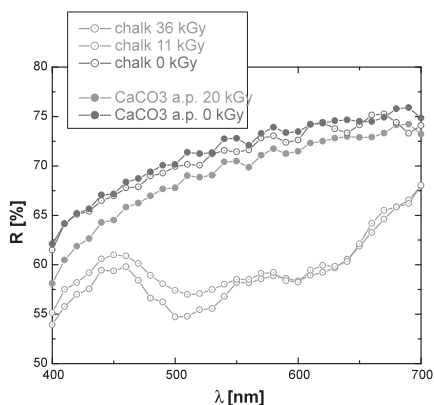

Fig.2. Reflectance spectra of chalk and calcium carbonate.

## 5. Conclusions

The presented tests provide just a part of information needed to validate the decision of irradiation treatment of wooden paintings. Modification of mechanical and structural characteristics of wood by gamma irradiation must also be evaluated.

It is known that aged materials are less sensitive to gamma irradiation due to their reduced water content (fewer free radicals during irradiation), so it could be significant to perform similar tests on aged materials. Also, the study should be extended to other pigments and binders used in traditional painting.

## References

1. Negut, C.-D., Ponta, C.C., Georgescu, R.M., Moise, I.V., Niculescu, G., Lupu, A.I.M. (2007): Effects of gamma irradiation on the colour of pigments. Proc. of SPIE Vol. 6618: 66180R 1-10.
2. Rizzo, M.M., Machado, L.D.B., Borrelly, S.I., Sampa, M.H.O., Rela, P.R., Farah, J.P.S., Schumacher, R.I. (2002): Effects of gamma rays on a restored painting from the XVIIth century. Rad.Phys.Chem. Vol. 63, Issues 3-6: 259-262.
3. Enguita, O., Calderon, T., Fernandez-Jimenez, M.T., Beneitez, P., Millan, A., Garcia, G. (2004): Damage induced by proton irradiation in carbonate based natural painting pigments. NIM. B: Beam Interactions with Materials & Atoms, Vol. 219-220: 53-56.
4. Chiari, M., Migliori, A., Mandò, P.A. (2002): Investigation of beam-induced damage to ancient ceramics in external-PIXE measurement. NIM B: Beam Interactions with Materials & Atoms, Vol. 188: 151-155.
5. Absil, J., Garnir, H.-P., Strivay, D., Oger, C., Weber, G. (2002): Study of color centers induced by PIXE irradiation. NIM B: Beam Interactions with Materials & Atoms, Vol. 188: 151-155.

# CONSOLIDATING WOODEN ART OBJECTS

*Hubert Baija*

Rijksmuseum, Amsterdam, The Netherlands  
H.Baija@rijksmuseum.nl

## Abstract

Field of Application: The conservation of objects of art and archaeology.

Objectives:

1. To establish a standard for reinforcing insect-weakened wood in cultural heritage, and
2. To develop a rational decision model for choosing the optimal consolidant – or a limited number of compatible consolidants – for wooden artifacts.

## 1. The problem

Are flexible consolidants better than rigid consolidants, and how to measure this?

Insect damage of wooden artifacts is a very common problem for many art conservators. The range of items they treat is large: wood sculpture, altarpieces, ancient Egyptian artifacts, carved ornamentation, panel paintings, frames, furniture, antique tools, toys, household items, and etcetera. In spite of the widespread need for consolidating wooden objects there is not yet enough clarity about which materials are best to use.

Indeed, very many different consolidants are currently in use, or have been in use in art conservation, such as:

- Protein glues (hide glue, sturgeon glue, fish glue, parchment size),
- Starches (dextrin, wheat paste, rice paste)
- Methylcellulose (Klucel types)
- Synthetic resins in solvents (Paraloid B72, Mowilith 20)
- Two-component synthetic resins (liquid polyesters)
- Pva emulsions in water (carpenter's glue, Mowilith DM5, DMC 2, DM427)
- PEG (poly ethylene glycol; mostly for waterlogged wood – problems already noticed).
- Natural resins (dammar, mastic)
- Silicon oil
- Wax



Fig. 1. Frame with insect damage, original for Madonna and Child stucco relief, by Luca della Robbia, Italy, third quarter of fifteenth century. Rijksmuseum Amsterdam, Inv. SK-L-6046. © Rijksmuseum.

Fig. 2. Detail of SK-L-6046: Filling insect damage with wax is ineffective and difficult to reverse.

We don't know enough about consolidation media and methods on the one hand, and the reaction of wood and its dimensional changes on the other hand. The extent of contraction and expansion of

wood may decrease over time, but the wood will still remain reactive to moisture absorption and release. Most consolidation is a partial impregnation because insect damage rarely affects all an artifact to the same degree. We may cause damage to the healthier parts of a wooden object in the long-term by introducing a consolidant, yet consolidation can be necessary to save an object from immediate damage. We need to be well informed about our treatment options.



Fig. 3. Detail of a mid-seventeenth century Dutch carved auricular frame (Rijksmuseum Amsterdam, Inv. Nr. SK-L-1006) showing weakening of structure and loss of form caused by insect damage.

Fig. 4. Hidden wood worm damage in an early seventeenth century picture frame calling for reinforcement. The front of this frame is covered with whale bone veneer and shows no sign of insect activity.

It is necessary to understand the interactions between the impregnated part of a wooden artifact and the remaining, healthy wood within the same object. With certain types of consolidants we may create new and possibly destructive tensions inside a wooden object by creating new, rigid structures. We may unknowingly create a 'timed decay' of the wood, pulverizing its remaining micro-structure by using rigid consolidants. We need to find out if rigid consolidants in general are more detrimental to a wooden object than flexible ones, and also to which degree the type of wood to be consolidated should be a factor in determining the type of consolidant. We also need to know if combinations of consolidants are compatible with possible re-treatment of the art object in the future.

## 2. Conclusion

It is necessary to develop a standard – or at least a consensus – for the consolidation of insect damaged cultural heritage, and to clearly communicate this standard to conservators of wooden art works.

For input or inquiries please contact:  
 Hubert Bajja, MFA  
 Senior Conservator of Frames  
 Rijksmuseum Amsterdam  
 P.O. Box 74888  
 1070 DN Amsterdam  
 The Netherlands  
 Tel. +31 20 674 7290  
 h.bajja@rijksmuseum.nl

## References

1. Unger, Achim (1988): "Conservation of Wooden Artifacts". Springer Verlag.
2. Schniewind, Arno P. (1998): in "The Structural Conservation of Panel Paintings". J. Paul Getty Trust.
3. Rivers, Shayne and Umney, Nick (2003): "Conservation of Furniture". Butterworth Heinemann.

# COMPARISON OF THE DETERIORATION AND CONSERVATION ISSUES OF WOODEN DOOR TYPES OF TRADITIONAL TURKISH HOUSES

Mine Tanac Zeren

Dokuz Eylul University, Faculty of Architecture, Department of Restoration, Izmir, Turkey  
mine.tanac@deu.edu.tr

## Abstract

In this paper, the types of wooden doors used in the Ottoman Traditional houses will be described, and classified. The deterioration issues will be put forward and will be compared with each other. And conservation issues will be raised.

There are four types of doors used in the Traditional Turkish buildings, and these are as follows;

- Batten Doors
- Panel Doors
- Kündekari Doors
- Metal-clad (kalamein)Doors

## 1. Types of doors

For the Ottomans, entry doors were major decorative elements often embellished with geometric, floral and calligraphic patterns, as well as inlays of ebony, mother of pearl, and ivory. Wood is the common material for the usage of the doors. These doors boasted fine bronze appointments, and were made of oak to ensure longevity. Less important doors, such as minaret balcony or toilet doors were left plain.

Doors are produced in one of the following way:

*Batten Doors:* These doors are the plainest doors of the listed above. They are usually used where they will not be highly visible. To build a batten door, the carpenter lays square-edged or tongue-and-grooved boards side by side, and joins them with additional lateral boards.<sup>1</sup> A third, diagonal board is added across the back to keep the door rigid.



Fig. 1. Batten Door Examples.

*Panel Doors:* Panel doors are made up of a number of panels placed between stiles and rails. The rigidity of panel doors depends on the quality of joints between the stiles and rails. Panel doors have similar appearance front and back (unlike *kündekari* or batten doors).

---

<sup>1</sup> Uluengin F.,(2007) “Klasik Yapı Detayları- Classical Structural Details of Wooden Structures”, Yem Yayınevi, İstanbul, pp:45.



Fig. 2. Panel Door Examples.

*Kündekari Doors:* *Kündekari* doors are made up of small pieces of wood laboriously fitted together. On doors with complex angular patterns, the number of pieces may easily run into the thousands. *Kündekari* doors are especially resistant to warping and shrinking because the individual pieces of wood are carefully placed such that each piece has its grain running in the opposite direction to those next to it; thus *kündekari* doors remain straight and true for hundreds of years. *Kündekari* doors have supporting panels on the inside (much like on a panel door), which provide for support of the *kündekari* pieces. *Kündekari* doors are among the most prestigious doors used by the Ottomans, and as such their stiles and rails are seldom left plain. Most are intricately carved with geometric, floral or calligraphic patterns.



Fig. 3. Kündekari Door Examples.

*Metal-clad (kalamein) Doors:* Metal clad wood doors are used where the door is exposed to the elements, such as those found at the entrances of courtyards. Iron, copper, or bronze is used as cladding material. Each is applied in similar fashion to beveled siding in 25-30 cm strips. The strips are attached to the wood substructure with oversized spikes. These spikes are arranged to create a pattern. Both sides of the door are clad.



Fig. 4. Metal-clad Door Examples.

## 2. Deterioration issues

Any approach to the problem of restoring or repairing an old wooden structure must be systematic. First one must discover the nature of the structural system and the species of woods which were used for the various elements. The wood “oak” is used generally in the structural and other various elements of Traditional Turkish houses because it is the most easily found tree among Anatolia. There are 18 types of oak tree in Turkey. So the door elements of the houses are made of commonly of oak tree.

Most of the wooden deteriorations are seen among the *batten type* of doors, because they are commonly used as indoor and outdoor circumstances so this door type is exposed to every air circumstance directly. Furthermore these types of doors are the plainest doors among all types. Structural deformations, fungi and insect attacks can be observed commonly within this type.

*Kündekari doors* and the *panel doors* because of their resistance behaviors to wrapping and shrinking have less deterioration problems than the other type of doors used within the territory. They have a joinery work of small wooden pieces which makes them more durable to the structural loads so less structural deformations are observed in this type of doors. The fungi and the insect attacks are rarely determined because these doors are used commonly in the indoor spaces.

The deterioration observed in the metal-clad door is different from the other types of doors. This deterioration problem cannot be observed within the other types of doors. Metal-clad doors have corrosion problems because the wood is used with metal elements. The metal-clad doors can be preserved from the fungi and insects attacks only in the case if the clad material surrounds the wooden door all around. But in the other cases such as using metal work partly in front or behind the wooden element, fungi and insect attacks can be observed on the wooden panels. The fungi and insect attacks are commonly determined because these doors are used mostly in the outdoor spaces.

## 3. Conservation issues

Timber, with rough stone, is the oldest building material the man used, also the most complete before steel was available, because it can be solicited both to compression and tension, therefore bending. Its use was continuous up to the present time.

The Timber decay in old buildings is caused by a variety of insect and fungal decay organisms, structural deformations, and corrosion deterioration. All of these cases can be seen in the types of doors mentioned above, batten doors, panel doors, *kündekari* doors, and metal-clad doors.

The conservation of timber structures has improved in recent years with a growing appreciation of



their historical significance. However there are still difficulties presented because of the limited number engineers with an understanding of timber structures. For the structural deformations, if old timber is very badly deteriorated, they can be totally replaced or, if some parts are still sound enough these may be retained<sup>2</sup>.

Structural deformations are seen mostly in the outdoor space's doors. Replacement of the deteriorated wooden parts of the doors can be easily used in *kündekari* and panel doors, because these types of doors are made up of small pieces. But it is not easy to make partial replacement in batten type of doors, so instead of partial replacement, totally replacement of the deteriorated wooden elements is preferred in this case of deterioration.

In the case of insect and fungal decay organisms, the use of chemicals against pests can be developed within all types of wooden doors. The organic insecticides and fumigants can be used within this case.

In the corrosion decay case of the wooden doors which are observed in metal-clad type of doors, the deteriorated iron, and copper elements can be replaced with the new iron or copper elements or by stainless elements.

### References

1. Uluengin F. (2007): "Klasik Yapı Detayları- Classical Structural Details of Wooden Structures". Yem Yayınevi, İstanbul.
2. Building Conservation & Renovation (2002).
3. Stumes P. (1979): "Structural Rehabilitation of Detoriated Timber". The Association for Preservation Technology, Ottawa.
4. Günay R. (2007): "Geleneksel Ahşap Yapılar Sorunları ve Çözüm Önerileri – Deteriation Problems, and Conservation Methods of Traditional Wooden Architecture". Birsen, Yayınevi, İstanbul.

---

<sup>2</sup> Günay Reha (2007), "Geleneksel Ahşap Yapılar Sorunları ve Çözüm Önerileri –Deteriation Problems, and Conservation Methods of Traditional Wooden Architecture", Birsen Yayınevi, İstanbul. pp. 32.

# STRUCTURAL USE OF WOOD IN TRADITIONAL TURKISH HOUSES

*Ozgul Yılmaz Karaman*

Dokuz Eylul University, Faculty of Architecture, Department of Restoration, Izmir, Turkey  
ozgul.yilmaz@deu.edu.tr

## **Abstract**

In Turkish Architecture, the use of the wood is very common and old tradition especially for houses. With their characteristic features, traditional Turkish houses are worth to be preserved. And to obtain best results it is necessary to evaluate and understand their structural system carefully. Then it is possible to choose most appropriate conservation technique for the wood construction. With this idea, in this paper, it is aimed to look at structural systems of houses from different regions of the country, and then discover the deformation degree of wooden elements as well as the reasons for these deformations.

## **1. Introduction**

In Turkish Architecture, the use of the wood is very common and also very old tradition especially for houses. That is because of the way of living of people as well as the geographical conditions of the place, where they live. And these Ottoman style houses with its tiled roof, extended timber and brick bays, all surmounting a heavy stone bearing wall base, has become an icon known worldwide [1].

The belief of the temporary human life of people and their routine of moving, make them to build simple timber frame houses with simple construction details. Because, if human life has an end, there is no need for the house to live forever. Besides this, the use of timber frame with simple joists shortens the construction period and allows more window openings [2]. Also, another important reason for using timber frame is living in the seismic zone, because, this kind of construction lightens dead loads of the building.

This housing tradition can be seen where the Turkish people lived. Factors such as climate changes, the existing building materials around, the topography and characteristics of the site, and wealth and population of the family make some differences between houses, which are built in different zones. But the use of structural elements is very similar in terms of both dimensions and construction method. The preferred timber type for the timber frame can differ from region to region. But in Anatolia, mostly, pine, fir tree, spruce tree, beech, oak and chestnut tree have been used for structural elements of the house. According to the strength of the used wood type the dimensions can be changed. For example, it is possible to use smaller sections for the studs and joists that made of oak or chestnut tree by comparing the elements that made of other kinds of wood.

## **2. Description of the structural system**

When we look at the structure of a traditional Turkish house, it is seen that most of the time the ground floor is surrounded by stonewalls of 45- 50 cm thick. Then the first floor's timber frame walls are constructed on them. The spaces in timber frame are usually filled with raw material, and then the wall is covered with plaster. But sometimes, instead of filling the spaces with raw material, the studs are made a little closer and then little timber lathes are nailed on them. Finally the surface is plastered. This method is named lath and plaster technique.

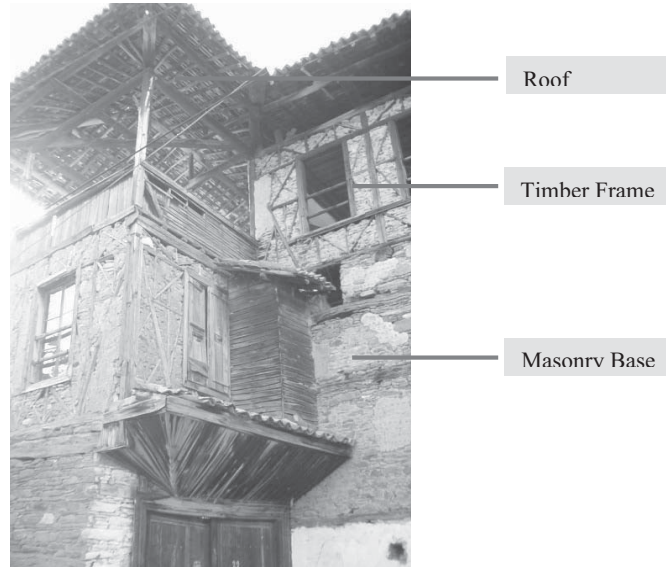

Fig. 1. Sections of a timber-framed Anatolian house, an example from Birgi.

### 2.1. Hatil construction

As mentioned above, the use of timber material can be seen in two different ways in these houses. First, it is used in stonewalls as horizontal beam, which embedded into the wall to strengthen it (Figure 2). This horizontal beam is named as “hatil” in Turkish and has a very important role in the case of earthquake.

Frequently these timber reinforcements consist of very thin timber boards laid into the wall like a course of masonry, at vertical intervals of about 1-1,5 meters (Figure 3). They are placed so as to overlap at the corners. They thus serve to bind the stone layers together without interrupting the continuity of the masonry construction [1].

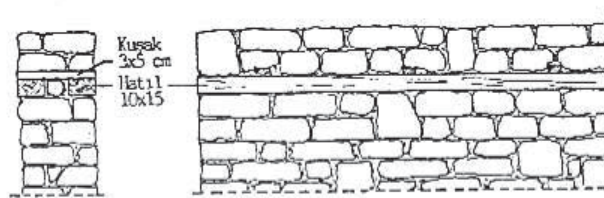

Fig. 2. The use of “hatil”– the horizontal timber beam- in the stone wall.

### 1.1. Timber frame

For most of the houses, in the first floor, the main material of the structural system is timber. The timber frame is constructed with simple columns and joists, which are usually connected by nails. The timber columns have the square section with dimensions of 10x10 or 12x12 in load bearing walls, but for the non-load bearing walls the sections can be smaller. Most of the time similar sectional dimensions are used for the timber beams of the frame.

As mentioned before, Genuine Turkish traditional architecture is intertwined with the traditional way of building. The overhanging jetties actually serve to strengthen the buildings because the joists, which extend well beyond the walls below, hold those lower story walls firmly in place with the weight of the overburden from the overhanging upper story. This compressive force gives the walls below added strength against lateral forces. The upper story, which is almost always constructed with a timber frame infilled with a single-wythe of masonry, is lighter than the bearing wall below, but reinforced against lateral forces by its frame. [1]



Fig. 3. The use of “hatil” – an example from Kula.



Fig. 4. The timber frame examples from (a) - Kula , (b) – Birgi Houses.

### 3. Deformation of the timber structure

When we look at the structural elements of the houses, some deformations can be seen especially in empty ones. Once they are left alone, windows and doors start to be useless, since windows get broken or doors get ruined by the rot. Also, deformation of the roof makes the structure affected by the weather changes, rain, wind, sunlight, temperature changes... etc.

Moisture is one of the main reasons of the color changes and deformations (Figure 5). Mostly because of the deformation of the roof, wooden structural elements are exposed to the moisture effect. On the other hand, the water that masonry filling of the wall consisted in can affect the timber elements. The degradation of the plaster also makes the wall less durable against the outer effects. Besides the color changes, fungus or/and rotting starts in the physique of the wooden elements when the degree of moisture gets higher.

Also, some small insects like termites can ruin the wooden structural elements. At this point of the study we have not had the chance of getting some samples to define what kind of insects are specifically effect the timber structure, although some holes that are caused by insects can be seen on the timber elements (Figure 6).

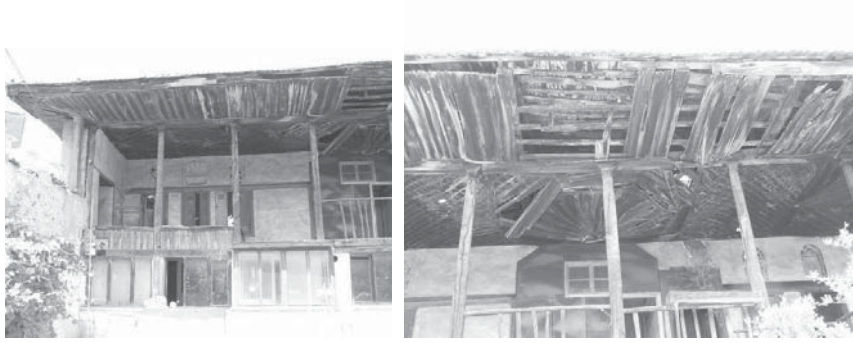

Fig. 5. Color change and deformation of the timber elements of the roof construction – Example from Kula.



Fig. 6. The holes caused by insects – Example from Kula.

#### 4. Conclusions and future remarks

Preserving the traditional houses of the Turkey is very important part of our conservation issues. And to obtain best results it is also very important to evaluate and understand their structural system carefully. Then it is possible to choose most appropriate conservation technique for the wood construction.

With this idea, in this paper, it is aimed to describe the use of wood in traditional Turkish houses as a structural element. Also paper is aimed to be a start point for the conservation proposals of the Kula houses. Because Kula is the one of the most important settlements of traditional life and there are many qualified examples of Turkish houses. The next step is aimed to be a more detailed evaluation of the deformations that are occurring in the structural elements and reasons for these deformations.

#### References

1. Langenbach, R. (2002): Survivors In The Midst Of Devastation, Traditional Timber and Masonry Construction in Seismic Areas. Proceedings of the Seventh U.S. National Conference on Earthquake Engineering, (7NCEE), EERI, Boston, July 21-25, 2002. Retrieved from: <http://www.conservationtech.com/rl's%20resume&%20pub's/RL-publications/Eq-pubs/2002-7NCEE/7NCEE-Langenbach1.pdf> on April 2009.
2. Gunay, R. (2001): Osmanli Konut Mimarisinde Ahşap Kullanımının Sürekliliği (Sustainability of use of wood in Ottoman Style Houses). EJOS IV, (= M. Kiel, N. Landman & H. Theneussen (eds.), Proceedings of the 11th International Congress of Turkish Art, Utrecht- The Netherlands, August 23-28, 1999), No.57: 1-22.
3. Guchan, N.S. (2007): Observations on earthquake resistance of traditional timber-framed houses in Turkey, Building and Environment 42: 840-851.

# DIAGNOSIS OF TIMBER STRUCTURES. A CASE STUDY

Lina Nunes<sup>1</sup>, Dulce F. Henriques<sup>1,2</sup>, Jorge de Brito<sup>3</sup>, Helena Cruz<sup>1</sup>

<sup>1</sup> Timber Structures Division, Laboratório Nacional de Engenharia Civil, Lisboa, Portugal

<sup>2</sup> Department of Civil Engineering, Instituto Superior de Engenharia de Lisboa, Portugal

<sup>3</sup> Department of Civil Engineering, Instituto Superior Técnico, Lisboa, Portugal

linanunes@lnec.pt

## Abstract

The need to intervene in timber structures is very frequent and especially so in the rehabilitation or conservation of ancient buildings. This paper presents the diagnosis work performed in the future “Wine Museum of Bucelas”, that was subjected in the last years to a total lack of maintenance, the main reason why different biological degradation agents had every condition to increasingly install themselves. The design and maintenance deficiencies of the building roof that led to the present damage level are also presented and related to the degradation problems they cause.

## 1. Introduction

Nowadays, it is consensual that old buildings are an integral part of the historical heritage to be preserved. Furthermore, the conservation of ancient buildings has proven to be a solution for modern societies from both the economical, environmental and cultural points of view. However, only in the last decades has this idea developed in society, allowing a generalized degradation and abandonment state of the greatest part of the built heritage.

Among the various buildings degradation factors moisture is the one that leads to the greatest damage in the most diverse materials and components [1]. Water and water vapour exert a direct action on timber, mortars, stone or ceramic pieces, affecting their durability. Their effects are very slow to become apparent, leading to a continuous and silent change of the materials, modifying their mechanical behaviour and leading eventually to the overall collapse of the buildings.

Timber is an organic material and moisture is its main degradation factor, leading to dimensional variations (shrinkage and swelling), fissures and warp development, changes in its mechanical properties and most of all allowing the installation of biological agents [2]. As a matter of fact, when factors like flawed design, poor construction practices and misuse of construction happen, chronic dampness in a structure (old or new) may lead to a cascading biological succession, from simple moulds to severe wood rot and insect infestation [3] particularly by termites.

In intervention procedures the initial stage has to be a thorough inspection and global diagnosis study of the building with special emphasis and detail on the timber structural elements and preferably including the understanding of the history of the building taking into account the original design and construction, any changes that have been made and obviously the effect of time [4, 5].

On that respect, the International Wood Committee of ICOMOS [6] recommends that a thorough and accurate diagnosis of the condition and the causes of decay and structural failure of the timber structure should precede any conservation intervention. The diagnosis should be based on documentary evidence, physical inspection and analysis, and, if necessary, measurements of physical conditions and non-destructive testing methods. This should not prevent however necessary minor interventions and emergency measures.

The inspection phase should be preferably articulated in three stages; according to Mannucci [7] and Cruz et al. [8]: a) Visual inspection; b) Use of auxiliary diagnosis means; c) Treatment of data and recommendations. From the visual inspection, meticulously performed with the aid of basic tools such as a knife or chisel, a lantern or a mirror, fundamental data for the development of the whole work can be collected [7, 8, 9, 10]. In what concerns the auxiliary means of diagnosis, there are various authors who elect the controlled perforation technique, *Resistograph*, as the one that better allies the ease of execution *in situ* with the type of data it provides. There are several scientific papers that present case studies in which the *Resistograph* technique is the only auxiliary technique used [11, 12, 13].

This paper presents the initial inspection work that was performed to evaluate the conservation state of an old timber structure, in which the four most common degradation agents in Portugal were simultaneously detected (wood rot, termites, house longhorn beetle and common furniture beetle) and an attempt was made to relate these defects to the design and maintenance deficiencies found in the building.

## 2. The building

The object of this study was a building from the end of the XIX century (1887, date inscribed in main door-stone) located in Bucelas, about 40 km north of Lisbon, Portugal. Old wine producers that used it, as dwelling, owned the building and it will soon be the subject of major rehabilitation works in order to become the Wine Museum of Bucelas. It has been vacant for several years.

Not much is known about the history of the building on its first hundred years but the obvious lack of maintenance and the abandonment in the last years has led to the overall state of degradation found, mostly due to diverse water entrances throughout the building.

Among them, the extensive moisture problems arising from the damage of the roof stand out, which promote permanent dampening of various constructive elements and simultaneously allow the proliferation of vegetation whose roots successively increase the degradation.

This degradation is not generalized and is located mostly near a façade and in the attic, the remaining construction elements remaining in a reasonable state. As Cid [14] wrote in the tender of the execution project for the rehabilitation works, the general state of conservation is reasonable, with only a few anomalies at the level of the roof and pavements, affected by water leakage from the roof.

The building (Fig. 1) is rectangular in plan and the staircase is centred providing direct access to all the compartments of both dwelling floors and to the attic. The external walls, apparently poorly braced, are in stone and solid brick masonry and the partition walls have a timber structure. The structure of the pavements, stairs and roof are exclusively of timber. The ceilings are made of gypsum with a cove, with a structure similar to the one of the pavements.



Fig. 1. (a) SW and SE facades of the building; (b) NE Facade; (c) Ceiling of a room in the 1<sup>st</sup> floor.

Cid [14] refers that the building has some interesting constructive details, namely the decorative stucco ceilings that ornate several rooms, some door-panels, the kitchen tiles, its stone pavement and the inner staircase.

The timber structure of the attic, made essentially of solid pine beams and round cross section eucalyptus rafters, is asymmetric in relation to the main façade since the building sits next to a cellar. It has three dormer-windows looking into the three facades SW, SE and NE.

## 3. Inspection work and diagnosis

### 3.1. General approach

To perform a thorough inspection work, it is convenient to have previous access to an architectonic survey of the building, based on which an inspection and test plan must be developed involving all the various actors in the design of its conservation or rehabilitation [15]. The inspection should begin on the outside of the building where the visible degradation locations of the envelope can be identified, since they are normally responsible for the water entrances and resulting degradation. Special attention must be drawn upon situations such as cracking of the mortar, broken roof tiles, soil or plants in the gutters and pounding in the terraces [8, 10].

Direct access to the timber elements, as well as conditions to observe them from every angle, are absolutely necessary, which implicates the use of elevation means and the removal of linings, masonry

and other constructive elements that hinder the access to the elements to be examined [9, 10]. It is then necessary to proceed with a superficial cleaning that allows a better visualization of the characteristics of the surfaces of each timber piece.

Visual inspection is the first process of a non-destructive evaluation [8] and it consists on the close analysis of the wood, either by visual inspection or with the help of a simple cutting object. It includes all the global analysis actions, such as the general survey of the structure and the causes of the damage (possible present or old water entrances, overloading, design errors, etc.), the location of the degradation, its severity and extension, its possible evolution, and the evaluation of the connections [7, 8]. The intensity of the biological degradation can often be evaluated with a knife or a chisel, with which the presence of soft or disintegrating material is detected, as well as its depth [8, 9]. To better observe the areas that are not directly visible, a mirror with a long or telescopic handle and a powerful torch can be very helpful [10].

In the present situation the preliminary inspection/inspection/diagnosis conducted was complemented by the use of non-destructive techniques (NDT) applied *in situ*. Moisture profiles were obtained with the help of surface moisture meters and particularly for insect damage the use of the *Resistograph* proved to be very helpful.

### 3.2. Preliminary diagnosis of the roof timber structure

The main beams of the roof structure were about 1.70 m above the floor, supported by vertical or diagonal shores (Fig. 2). There are also beams at about 2.50 m braced by horizontal joists nailed to the beams and supported by a hanger connected to the ridge. The beams support round (aprox. 12 cm cross section diameter) eucalyptus rafters that present significant warp and abundant drying fissures. The roof structure does not present any detachments of joints or mechanical deformations due to the resistant capacity of the elements having been exhausted.



Fig. 2. General view of the structure.

As a first approach to the diagnosis, a direct visual and mechanical analysis of the wood was performed, by using a knife in various locations and micro-drilling tests with the *Resistograph* in the pieces that raised more doubts on their degradation state (Fig. 3). The data obtained for wood rot and insect attacks were thoroughly registered over the geometrical survey of all the structural sets.

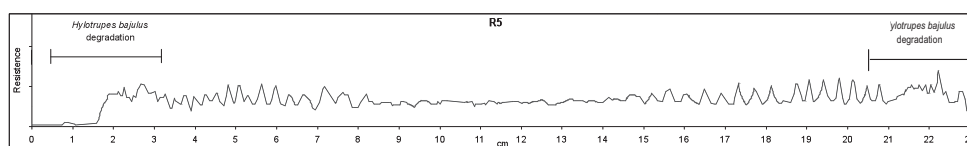

Fig. 3. Profile of the *Resistograph* measurement in a degraded piece

Degradation by the house longhorn beetle (*Hylotrupes bajulus*) was detected in solid pine. The *Resistograph* was used to obtain the profile of a beam that showed a number of exit holes of *H. bajulus*,



drilling in the middle of the smaller face and crossing the complete section of the element (22 cm). The internal structure of the element was approximately symmetric with a 2-3 cm deep zone in the extremities with an irregular resistance, denoting the presence of different elements, i.e. the galleries and the non-degraded fibres. Afterwards, a perfect regularity corresponds to the alternation between the non-degraded spring and autumn rings. The central part shows the least resistance, corresponding to a tangential cutting of the rings and possibly to juvenile wood around the pith (Fig. 3).

Although most of the timber structure seems to be in a reasonable state of conservation, on the North-East side (Fig. 1b), part of the eucalyptus timber rafters were found to be heavily degraded by rot fungi and subterranean termites, particularly in the supports, reaching a level close to collapse (Fig. 4).



Fig. 4. Detail of the eucalyptus rafters showing destruction by wood rot and subterranean termites.

#### 4. Design and maintenance defects

Of the various types of biological degradation present in the timber elements of this building and described in the previous chapter only the house longhorn beetles are not related to the presence of water in the construction.

As main factors for the generalized state of biological degradation in which the timber elements are found, the following can be cited.

##### 4.1. Inexistence of treatment of the timber elements

Though the history of the building is not well known, the generalized presence of wood-boring beetles in the building suggests that all wood was applied without any treatment as it was common practice in Portugal at the time of construction and even throughout the next century where some rebuilding and alteration of the original house has certainly occurred.

The common furniture beetle was detected active in stairs, panels, door-posts and roof beams. By visual analysis and Resistograph measurements it was concluded that the attack was not very extensive, allowing the possible continuation in service of the elements attacked after dully treatment.

The house longhorn beetle was detected in the pine structural elements of the attic pavement and in the supporting beams of the roof structure. Its presence was confirmed in a quite considerable quantity and extension, though a more extensive analysis led to the conclusion that most of the degradation was superficial reaching a maximum of 2 to 3cm depth in beams with larger amounts of sapwood.

##### 4.2. Rain water intake through the roof

The origin of this problem is the degradation of the tiles and any existing insulating material over the joint between each of the dormer-windows and the roof. Due to lack of maintenance, part of the rain water that trickles over the vertical plans of the dormer-windows is no longer drained to the outside and penetrates the attic. The consequence of this situation was, at first, the installation of rot fungi and, later on, due to the permanence of the dampness of the wood framing and pavements, the access of termites that went up the masonry walls. Due to this last agent, the loss of material is almost total. The penetration of rain water in singular locations of the roof due to the failure or displacement of roof tiles also caused localized degradation by fungi, which will cease when the deficiency is repaired.

#### 4.3. Water intake due to the uncontrolled growth of plants on the façade and the roof

This is unquestionably a problem of lack of maintenance. A creeping plant that is allowed to grow clinging to the wall of the building promotes various water entrances, either through the mortar or the masonry or through the roof tiles and other covering materials of the roof. The plant opens up channels for the water passage at the same time that it promotes its permanence, greatly increasing the inner humidity of the masonry and the moisture content of the timber elements. On the other hand, it promotes the accumulation of debris and soil.

The situation described originated the development of rot fungi, whose attack occurred at a decreasing level from the attic to the ground floor, but also the settling of termites with an attack path in the opposite direction, as described in Figure 5.

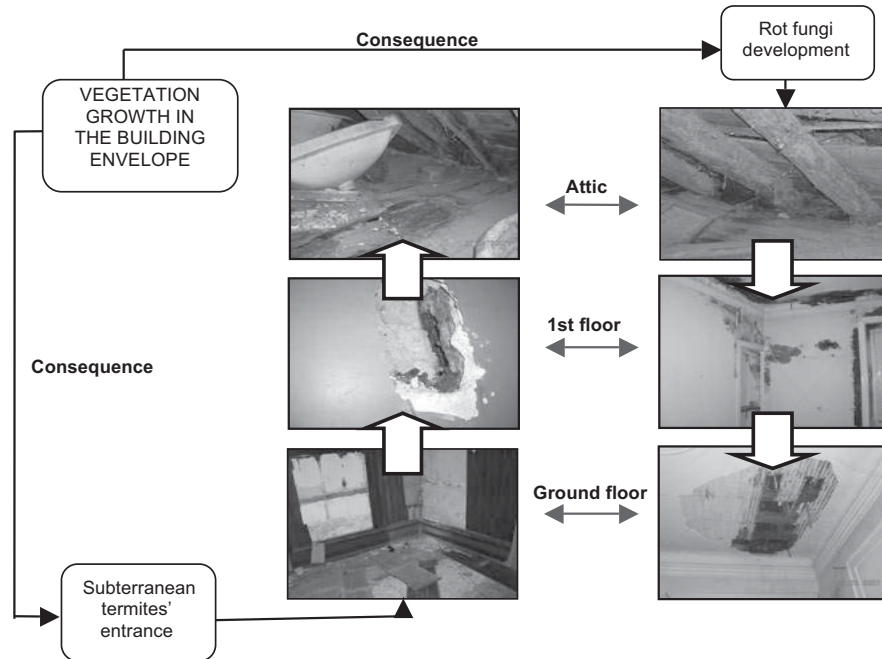

Fig. 5. Schematic representation of the type of degradation due to the presence of vegetation on the façade and roof of the building

## 5. Conclusions

The objective of the preliminary inspection described in this paper was to give the owners of the building an idea of the possible paths that should be followed to restore what seemed like a much degraded building to its original dignity.

A multi-disciplinary approach will obviously be needed to implement a restoration project but in general the major deficiencies of the applied wood were detected and several causes for the present state of degradation were identified, most of them clearly related to the abandon state to which the building was subjected.

## Acknowledgements

The support throughout this work of the Department of Municipal Works of the Loures Municipal Council, represented by Lucília Reis, is acknowledged. The work was partly a result of the authors' participation in COST ACTION IE0601 "Wood Science for Conservation of Cultural Heritage".

## References

1. Lourenço, P.B., Luso, E., Almeida, M.G. (2006): Defects and moisture problems in buildings from historical city centres: a case study in Portugal. *Building and Environment* 41: 223-234.
2. LNEC (1997): “Madeira para construção. Humidade da Madeira”. Laboratório Nacional de Engenharia Civil, Portugal. CDU 691.11:620.193.23. ISSN 0873-6472.
3. Clausen, C.A., Yang, V. (2007): Protecting wood from mould, decay, and termites with multi-component biocide systems. *International Biodeterioration & biodegradation*, vol. 9, Issue 1, pp. 20-24.
4. Binda, L., Saisi, A., Tiraboschi, C. (2000): Investigation procedures for the diagnosis of historic masonries. *Construction and Building Materials*, 14: 199-233.
5. Lourenço, P.B. (2006): Recommendations for restoration of ancient buildings and the survival of a masonry chimney. *Construction and Building Materials*, 20: 239-251.
6. ICOMOS (1999): Principles for the preservation of historic timber structures. International Council on Monuments and Sites. Online at [http://www.international.icomos.org/charters/wood\\_e.htm](http://www.international.icomos.org/charters/wood_e.htm). 2008/02/18.
7. Mannucci, M. (2001): Diagnosi dello stato di conservazione di strutture di legno massiccio e lamellare, SAIE 2001 - Workshop StrutturaLegno: Le regole del Legno - possibilità tecniche.
8. Cruz, H., Machado, J.S., Nunes, L. (1999): Inspeção e avaliação de estruturas de madeira, Estruturas de madeira: reabilitação e inovação. GECO RPA: Lisboa, pp. 13-28.
9. Feio, A., Lourenço, P.B. (2005): Possibilidades e aplicações de ensaios não destrutivos. Encontro sobre a madeira e suas aplicações nobres - Bem utilizar a madeira; Universidade do Minho, INETI.
10. Berry, R.W. (1994): “Remedial treatment of wood rot and insect attack in buildings”. Building Research Establishment, Watford.
11. Valle, A., Brites, R., Lourenço, P.B. (2006): Uso da perfuração controlada na avaliação de degradação da madeira em edificações antigas - estudo de caso. 10º Encontro Brasileiro em Madeiras e Estruturas de Madeira. EBRAMEM 2006, São Pedro, Brasil.
12. Ceraldi, C., Mormone, V., Ermolli, E.R. (2001): Resistographic inspection of ancient timber structures for the evaluation of mechanical characteristics. *Materials and Structures*, vol. 34 (1), pp. 59-64.
13. Lauriola, M., Mannucci, M., Moschi, M., Macchioni, N. (2000): A reliable inspection procedure of existing timber structures: the case of Guarini's Towers roofs - Racconigi Castle (Italy), 15<sup>th</sup> World Conference on Nondestructive Testing, Italy.
14. Cid, J. (2006): Memória Descritiva do Projecto de Execução de Arquitectura do futuro Museu do Vinho de Bucelas, Câmara Municipal de Loures, Departamento de Obras Municipais, Divisão de Obras e Manutenção.
15. Teles, C., Valle, A. (2001): Wood structures: Acting before deterioration, Proceedings of the 3<sup>rd</sup> International Seminar Historical Constructions, 2001, Guimarães, Portugal, pp. 857-866.

# TECHNOLOGICAL ANALYSIS OF SOME ALBANIAN ICONS, CARRIED OUT AT DEPARTMENT OF WOOD TECHNOLOGY, UBT, TIRANA

Hektor Thoma, Dritan Ajdinaj, Etleva Bushati, Holta Çota, Entela Lato, Doclea Quku

Department of Wood Technology, Faculty of Forestry Sciences, Agricultural University of Tirana, Albania

hektor\_thoma@hotmail.com

## Abstract

The results of observations carried out on a number of icons, concerning the typology, constructive features and state of conservation, represent important information for their restoration. Four icons are in process of restoration under the direction of the Centre of Restoration of Berati. Studies were made for identification and deterioration of wood. The technique used for anatomic study of wood is the resin inclusion. The microscope observation shows that three icons belong to *Juglans regia* L. and only one belongs to *Populus alba* L. For inspection of wood deterioration accurate observations and measurements were done, which show a considerable fungal decay and insect damages, especially from *Anobium punctatum*. Also, there are under observation process the parameters of temperature and relative humidity of the air with the aim to determine the possible icon deformation.

## 1. Introduction

Medieval picture in Albania is represented by a considerable number of works. Many of them have an artistic quality which passes the borders of the national interest. These pictures are in general icons conserved in churches and monasteries. The most ancient of them belong to the XII century (Popa, 1974).

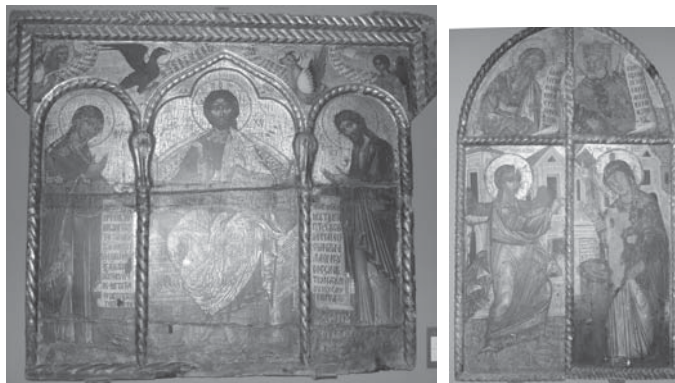

Fig. 1. Onuphre Qiprioti, *Deesis*, 1596. Tempera on panel, 76 x 67cm. The mother of God and Saint John the Baptist praying Jesus for the salvation of humanity.

Fig. 2. Onuphre Qiprioti, *Beautiful door*, 16<sup>th</sup>-17<sup>th</sup> century, Evllaherna church – Fortress Berat.

In the mid XVI century the first Albanian painters active in mural paintings and iconography appear. Among them the most famous was Onuphre of Neokastra (Elbasanit), followed by other painters like his son Nikolla, Joani and other collaborators of him. It is documented that he had worked in Albania in the period 1591-1615. He painted with the technique of tempera on wooden supports. A part of his work is exposed in The Old Icon's Hall of the National Museum of Tirana and in the Berat Museum.

The icon named “Deesis” (dimensions 79x67 cm fig.1), dates from 1596. It is exposed in the national Museum and belonged to the church of Saint Nicolas in the village Paftal, district of Berat. He painted not only the icons but the other elements of iconostas one of them is named “Beautiful door” (fig.2), dates 16<sup>th</sup>-17<sup>th</sup> century belonged the Evllaherna church – Fortress Berat. He was the

first painter who created the first painting school in Albania.

During the XVII century, the Albanian iconographs decorate with sets of icons many mid and south Albanian churches and monasteries.

The icons of the Albanian painters of the XVIII century belong to the school of Korça and show influences from Athos' painting and from the western art. On the works of the painters Kostandin e Athanas Zografi are observed features from the baroque style. From this period there are also a few icons found that belong to the school of Crete. There are thousand of icons that decorate the monuments of the XIX century.

The actual situation related to the study, conservation and the restoration of the icons in Albanian isn't satisfactory. The elements leading to such conclusions include:

- documentation; is partial. Icons are described only by the artistic viewpoint. There is a lack of the accurate information about wood species, structure and supports, the biodegradation and the used paints. On the same time the chronological information about the restorations is completely lacking.
- conditions of conservation; problematic ones, especially in museum of Berati. The storage room of icons in Berati is exposed to inappropriate environment hygrometric parameters.
- performed restoration interventions; until now the interventions have consisted only on cleaning and restoration of the painting layer.

The aim of this paper is to present the work in progress in the framework of the cooperation between the Department of Wood Technology, Faculty of Forestry Sciences and the Institute of Monuments.

This cooperation consists in:

1. identification of the wood species of the icons;
2. (Four icons are identified and are in process of restoration under the direction of the Centre of Restoration of Berati. Fifteen other icons which are foreseen for restoration, the identification is in process).
3. inspection of the state of conservation of the whole wooden supports.
4. (Four icons mentioned above are inspected)
5. deformations monitoring;

Icons which actually are in process of restoration are:

- *Christ Pantocrator* – anonyme;
- *Over grave crying, Christ Crucifying* and *Source of Life Givens* – 18<sup>th</sup> century, Çetiri brothers.

## 2. Material and methods

### *Icon construction*

Icons are wood paintings with religious content. We have two types of them: icons painted as separate pieces and icons incorporated on iconostases. Icons are with different dimensions.

The small dimension icons are mainly placed in the upper front part of the iconostases. The smallest icons are composed by a single plank. Their dimensions vary from 35 to 50 cm width 29.5 to 45 cm. Their thickness is 17 to 30 mm.

In Albania, the single plank icons were commonly used. The dimensions of single plank icon vary from 45-70 cm width and 25-50 mm thickness.

Larger icons are composed by two or more planks. In the two planks icon the width of the planks are usually similar. However in many cases we face icons with different plank width. In this icon category, the selection of the planks dimensions that compose the wood support is conditioned by the picture's composition. The used planks width is 25-40 cm.

In compositions with larger dimensions (over 100x70 cm), the wood support has three planks. This type of support is characterised by the use of a wider plank in the middle flanked by two narrower ones.

The three plank icons were mostly used during XVIII and XIX centuries. Saint Maria and

Christ-1777, is composed by three planks the width of which is (from left to right) 14.8 cm, 40 cm and 18 cm (fig. 3). Some icon supports of XIX century are composed by pretty wide middle plank and by two narrow flank planks.

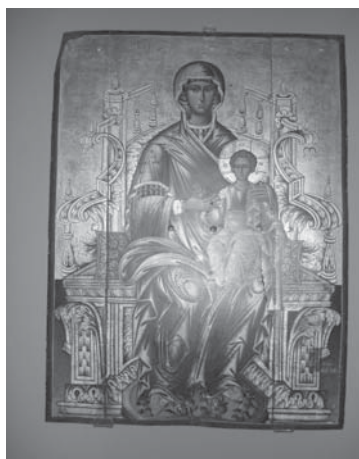

Fig. 3. Johan Athanas, *Santa Maria and Christ*, 1777, Gjirokastër.

It is thought that such a support choice was made by the painter conditioned by the composition nature of his painting. This type of support compositions is found also in the cases where the paint is repainted after a certain period. The repaint process means that the certain elements are added on the support of the picture.

The support plank joining was made by using animal glue. Most of the planks had edge joints with previous roughening of the surface for better adhesion. Most of supports of Albanian icons of the XIV–XVI are realised by this kind of joint.

In the XVII–XIX centuries, where icons started to be painted in larger supports the butterfly keys mortised in the planks were frequently used. The panels were glued and then reinforced with butterfly keys. If the butterfly keys were used, they were placed mainly on the front of the panel, and with time they often began to show through paint layer. Over the finished wooden support was applied the ground and canvas (not in every case).

Typically, in three planks support with narrow flank planks, the narrow ones were joint with the middle plank by wrought-iron nails and animal glue as well (Michael Anagnosti, *Christ Pantocrator*, 19<sup>th</sup> c, Cathedral-Elbasan).



Fig. 4. Nailed crossbeam. Johan Athanas, *Santa Maria and Christ*, 1777. Gjirokastër.

Figure 5. Dovetailed crossbeam. Anonym, *Saint Nicole*, 18<sup>th</sup> c, Berat.

Crossbeams have the main function of maintaining the support continuity as well as insuring the planarity of the surface. Until the XVI-th century the connection between crossbeams and planks

was made using wrought-iron nails. In the later centuries the dovetailed crossbeams were used. The joints were made in two ways:

- The nail head is situated on the front side of the paint support while the shaft was U - shape turned within the wood crossbeam;
- The nail head is situated on the back side of crossbeam while the shaft was U - shape turned within the wood facing the picture support.

Different from the nail join crossbeams, the dovetailed ones allow a reciprocal movement system. The connection between crossbeam and support makes possible an even distribution of constraining forces along the whole crossbeams and avoids the concentration of such forces in the nailed points.

### ***Wood identification***

For wood identification of icons small samples were taken very carefully using a sharp cutter. The location where the samples were extracted was the back corner edge of the panel, in manner the art object to be not damaged. The size of fragment ranged from 1 to 3 mm in width, and several millimeters in length up to 1 cm (Romagnoli & the others, 2007).

The first step was the verification by stereomicroscope for choosing the good parts of samples which will be treated later.

The technique used for anatomic study was the resin inclusion. After the resin was prepared (based in butyl), the samples were put in glass containers filled with mixture of resin and absolute alcohol in equal amounts. The samples stayed in these containers for one hour. The same procedure was repeated by passing the samples in pure resin staying there for 1.5 hour. In the end, the samples were placed in capsules filled with resin, which were placed in thermostat in a temperature of 60 °C for 12 hours.

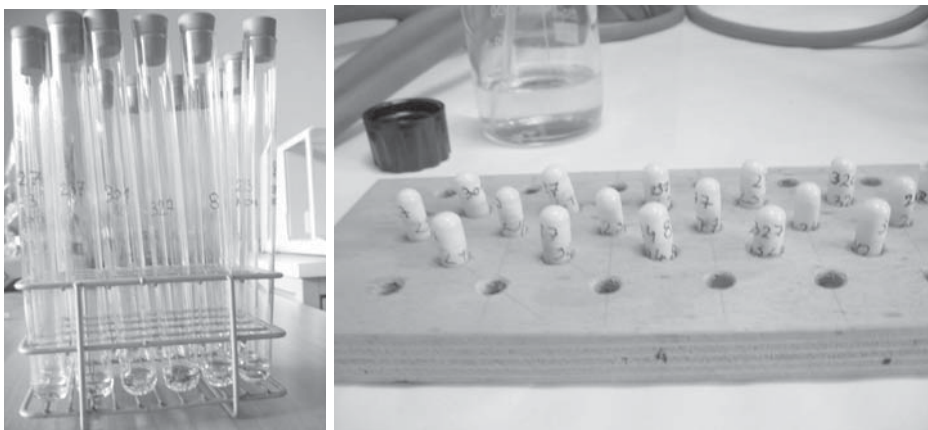

Fig. 6 Inclusion of samples in resin.

Fig 7. Samples in capsules after thermal treatment.

After the resin polymerization in thermostat and the equilibration in the environmental temperature for two days, the capsules were open and the resin together with the samples was cut by microtome and fixed in microscopic glasses using glycerol, ready for anatomical observation.

### ***Inspection of wood deterioration***

By an accurate observation performed on the panel paintings it was found that the major part of them show decay by fungi attack, especially in external sides (figure 10).

Also were verified considerable damages by wood-boring insects (in many of panel paintings the tunnels were extent till to the paint layer. For identification of the wood-boring insects were proceeded as below:

- measurement of holes diameter and observation of the tunnel form;
- observation of tunnels orientation according to the direction of grain;
- analysis of the color and pellets characteristic of insect frass (Blanchette, 1995).

### ***Monitoring of deformations***

Observing the conditions of icons conservation in their respective deposits in Albania, was judged as a necessity the monitoring of environmental parameters (temperature and relative humidity of the air) and the possible icon deformations caused by the variation of these parameters. This observation is under process from several months.

## **3. Results and discussions**

### ***Wood identification***

For four panel paintings which actually are under restoration, the identification of wood species (Nardi Berti, 2006) showed that three of them (*Christ Pantocrator*, *Over grave crying*, *Christ Crucifying*) belong to *Juglans Regia* L. and the other one (*Source of Life Givens*) belongs to *Populus* spp.

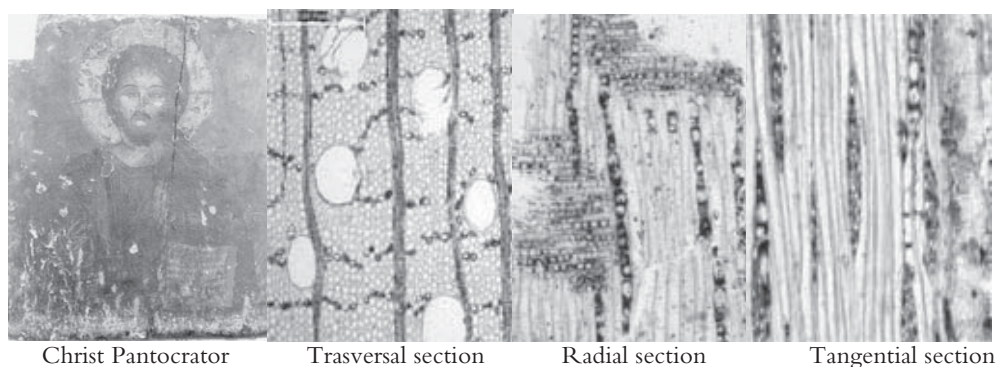

Fig. 8. Anatomical sections (*Christ Pantocrator*)

### *Anatomic description:*

- Transversal section; Diffuse porous. Isolated large pores. Apotracheal parenchyma in layers and diffuse. Tyloses present.
- *Radial section; Heterogenous and homogenous rays.*
- Tangential section; Simple perforation plate. Rays most often 2-4 cells wide, occasionally uniseriate. Average ray height 15-30 cells.

*Key characteristic; Solitary pores sparsly scattered. Rays 2-4 cells wide. (Juglans regia L.).*

The result of this anatomical description also is confirmed by the widespread of *Juglans regia* L in forests of Osum's valley (Mitrushi, 1956), South of Albania, where are located the churches of icons. *Juglans regia* L was appreciated by the local craftsmen to carry out their works, because is suitable for painting and gluing.



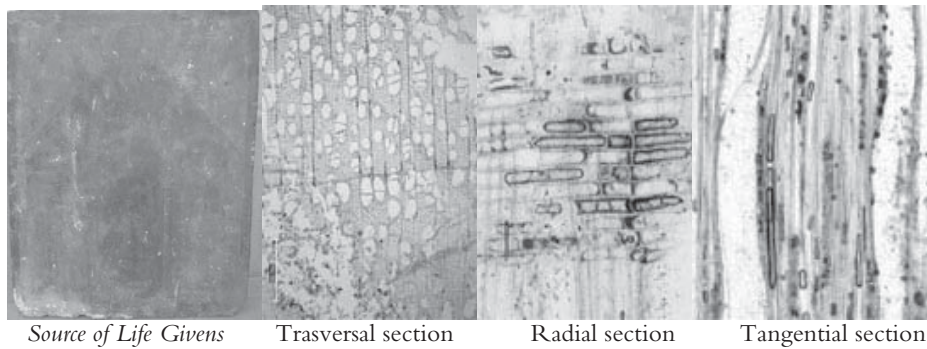

Fig. 9. sections (*Source of Life Givens*).

*Anatomic description:*

- Transversal section; Diffuse porous. Pores are solitary or in radial files of 2-3. Diffuse and terminal apotracheal parenchyma.
- Radial section; Homogenous rays. Large ray-vessel pits.
- Tangential section; Simple perforation plate. Uniseriate, homogenous rays. Ray height: 5-30 cells.

*Key characteristic; Diffuse porous. Uniseriate homogenous rays. Large ray-vessel pits; Populus spp. (Schweingruber, 1990)*

In this case is more probable to be *Populus alba* L because is the only popular specie grown naturally in the region of Myzeqe, South Albania near of Berati (Marku, 1999), where also were located a considerable Byzantine churches.

***Identification of wood-boring insect in panel paintings***

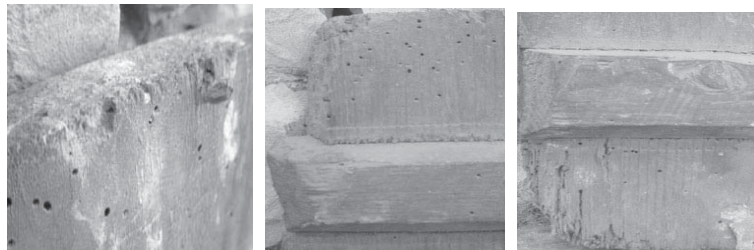

Fig. 10. Fungal degradation and insect damage in panel paintings.

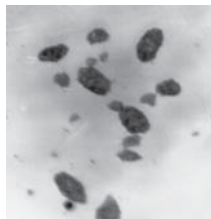

Fig. 11. Pellets of *Anobium* frass.

From inspection of panel paintings are verified meandering tunnels 1-2 mm in diameter, often in direction of grain, filled with frass consisting of oval pellets and wood powder (figure 11). (There was fungal decay in peripheral zone of panel painting). According the key for identifying

wood-boring insect (Bravery & others, 1992) resulted common furniture beetle (*Anobium punctatum*).

#### 4. Conclusions

From observations carried out in the framework of this study resulted that icons of XII<sup>th</sup> ÷ XVI<sup>th</sup> centuries have thinner thickness (17÷30 mm) and their support is composed by one or two planks. Latter on, the thickness of support becomes thicker (25÷50 mm) and the number of planks increases. The use of the single plank icons was commonly used by the masters of that time, since the use of wider planks avoided the number of joins and the possibility of support crack in the join parts. There are no written rules for three planks support, but the study notices that the width of the middle plank is often more than twice of the width of flank planks. The reinforced butterfly joins placed on the back part of the panel are additional joints made latter on to avoid the problems noticed in the support of the icon.

The identification of wood species carried out before the process of restoration of four icons of Berati's Museum, showed that were used the native woods. *Juglans regia* L was used in three icons and till to nowadays is very appreciated by local craftsmen to carry out their works. New thing is *Populus alba* L., which was identified in the fourth icon. This wood is spread in the region, but traditionally not appreciated by the woodworker.

Was found that the major part of the four icons show decay by fungi attack, especially in external sides. Also were verified considerable damages by wood-boring insects, which resulted common furniture beetle (*Anobium punctatum*). The tunnels were extent till to the paint layer.

The work presented in this paper is novel to Albania. Also, a part of the information resulted from this work was unknown till now. The significance of interdisciplinary collaboration has reformed the restoration of icons in Albania in a process based on scientific methods. Because of restoration of icons is a complex process dealing not only with painting, the future developments regard to identification of wood species of icons of Museums in Tirana and Berati. Also, the monitoring of icon deformations caused by the variation of environmental parameters in Museum of Tirana, will go on.

The following cooperation in carrying out the work described in this paper is gratefully acknowledged by the Authors:

- preparation of anatomical samples was carried out in laboratory of DISTAF, Florence, Italy, in collaboration with Giusepina Di Giulio, under supervision of Prof. Marco Fioravanti.
- director and conservators of Museum of Berati for their positive attitude towards collaboration.
- Institute of Monuments which transformed the collaboration with Wood Department in institutional level.

#### References

1. Arapi, M. (1984): Conservation and restoration of the main part of Evangelismos church in Berat. "Monumentet" Magazine, Tirane.
2. Blanchette R. A. (1995): A guide to wood deterioration caused by microorganisms and insects. In: The Structural Conservation of Panel Paintings, Proceedings of a symposium at the J. Paul Getty Museum), Los Angeles.
3. Bravery, A. E., Berry, R. W., Carey, J. K., Cooper, D. E. (1987): "Recognizing wood rot and insect damage in buildings". Building Research Establishment, Watford, England.
4. Giordano, G., (1981): "Tecnologia del legno". Vol. 1, UTET, Torino.
5. Marku, V., Xheko, B. (1999): "Dendrologia". Universiteti Bujqesor, Tirane
6. Mitrushi, I. (1966): "Druret dhe shkurret e Shqiperise". Instituti Bujqesor, Tirane
7. Nardi Berti, R. (2006): "La struttura anatomica del legno ed il riconoscimento del legnami italiani di più corrente impiego". II edizione, CNR-IVALSA, Firenze.
8. Popa, T. H, (1974): "Ikona dhe miniatura mesjetare ne Shqiperi". Tirane
9. Romagnoli M., Sarlato M., Terranova, Bizzari, Cesetti (2007): "Wood identification in the Cappella Palatina ceiling in Palermo (Sicily, Italy)", IAWA volume 28 (2).

10. Schweingruber, H. F. (1990): "Microscopic Wood Anatomy". Swiss Federal Institute for Forest, Birmensdorf
11. Uzielli, L., Fioravanti, M. (1999): "Il comportamento fisico-meccanico del legno nei dipinti su tavola. In: M. Ciatti, C. Castelli, A. Santacesaria (a cura di) "Dipinti su tavola – La tecnica e la conservazione dei supporti", Edifir, Firenze, 37:58.

# MECHANICAL MODELIZATION AND HOLOGRAPHY MEASUREMENT: APPLICATION TO THE RESTORATION AND CONSERVATION OF THE COUCHET HARPSICHORD

*Sandie Leconte<sup>1</sup>, Sylvie Le Moyné<sup>2</sup>, François Ollivier<sup>2</sup>, Stéphane Vaiedelich<sup>1</sup>, Joel Frelat<sup>2</sup>, David Ley<sup>3</sup>,  
Christine Laloue<sup>4</sup>, Jean-Claude Battault<sup>1</sup>*

<sup>1</sup> Laboratoire du Musée de la musique. Paris. France

<sup>2</sup> Institut Jean Le Rond d'Alembert. Université Paris VI. Paris. France

<sup>3</sup> Harpsichord maker. Switzerland

<sup>4</sup> Musée de la musique. Paris. France  
sleconte@cite-musique.fr

## Abstract

The Musical Instrument Museum in Paris has recently acquired a harpsichord made by Joannes Couchet in 1652 in Anvers. As a rare masterpiece this instrument is protected as a "National Treasure". Many challenging problems were to be confronted when its restoration was decided in favour of returning the instrument again to playing condition. It appears particularly important to understand the mechanical effects due to the string charge as well as variations of hygrometry on stringed keyboard instruments. In this objectives, improve a numerical model currently in process and develop a diagnostic method for conservation, an experimental modal analysis of the soundboard was performed.

## 1. Introduction

The harpsichord is a complex mechanical structure for which the stress due to string tension and hygrometric variations was obtained with simplified mechanical rules. The contribution of the numerical modelization, based on the finite element method is important to anticipate the restoration, and to evaluate the effects of the climatic variations as well as understanding the vibration properties.

The different solutions for the restoration can be added to the model. First of all results coupled with the know-how of skilled harpsichords restorers have allowed us to decide the restoration protocol, satisfying both playability and conservation aspects.

After that, the instrumentation of the harpsichords can be realized. For that, we apply a non-intrusive technique which directly measures acoustical pressure field radiated by the vibration soundboard. This technique, called impulse nearfield acoustical holography (INAH) allows the calculation (inverse method) of the whole soundboard deformation (modal analysis) from a near field measurement non contact. Moreover, this experiment can give us a better understanding of the harpsichord, in order to improve the modelization. In terms of conservation, this experiment could be conducted regularly to help us with the diagnosis of the mechanical state of its constitutive elements, keeping in mind the fact that any modification of the structure of the vibrating elements leads to a variation in the acoustic response from the instrument.

## 2. Numerical modelization: a tool for the restoration

The soundboard of the harpsichord was damaged when the museum acquired it. To restore it, the strings had to be taken off. Is the wood still in the elastic domain? What will happen when the strings will be tensed again? To answer these questions, we have developed a mechanical model of the harpsichord, based on finite elements, and compared the deformation calculation with the relaxation measurement of the soundboard.

### 2.1. Model definition

The first step of the model definition is the geometric measurement of the harpsichord. External elements such as the soundboard, the bridges, the wrest plank and the nuts have to be sized precisely to take into account the curvatures. Radiography was realized to locate the eight internal rigidity bars. Then, all parts of the instrument are meshed using orthotropic plaques (DKT elements [1]) or isotropic bars with the Cast3m finite elements code. Finally, the limit conditions of the soundboard are embedded all around its outline.

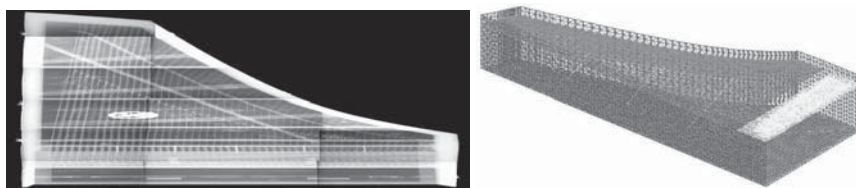

Fig. 1. Radiography (a) and meshing (b) of the Couchet harpsichord.

Once the geometry is defined, the second step consists in the application of the forces on the model. External forces are due to string tension. There are 150 strings that lead to 6700 N applied on the soundboard (which has a mean thickness of 3 mm). Before the strain and stress calculation in the soundboard, we have to introduce in the model the mechanical properties of the various wood species used in the harpsichord. Xylology permits identification of the wood used but elastic parameters and density are taken in a database [2]. Indeed, the harpsichord is a cultural heritage object it's not possible to remove a sample large enough to measure its mechanical constants. All these constants are described in the table 1.

Table 1. Elastic constants of different species.

Harpichord element	Wood species	Young modulus (GPa)	Density (kg/m <sup>3</sup> )
Soundboard (orthotropic shell)	spruce	YG <sub>1</sub> = 11 YG <sub>2</sub> = 1.4 G <sub>12</sub> = 1.364	400
Bridges (isotropic bar)	maple	YG = 10	500
Nuts and wrest plank (orthotropic shell)	oak	YG <sub>1</sub> = 12.5 YG <sub>2</sub> = 1.9 G <sub>12</sub> = 1.1	610
Bottom and bentside (orthotropic shell)	poplar	YG <sub>1</sub> = 9 YG <sub>2</sub> = 1 G <sub>12</sub> = 5.5	410
Upperbraces and upper bellyrail (isotropic bar)	poplar	YG = 9	410
Rigidity bars	spruce	YG = 11	400

## 2.2. Calculation results and model validation

We are first interesting in the vertical deformation.

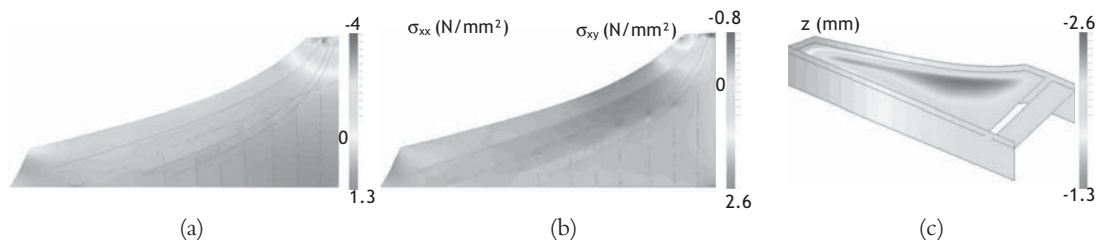

Fig. 1. Castem calculation results for shear strain (a), longitudinal strain (b) and deformation (c).

The first results concerning the stress are in accordance with the actual deformation of the soundboard. Indeed, the cracks are located at the same place as the maximum values calculated (upper right corner on figure 2(a) and 2(b)).

It is also possible to compare the deformation values obtained by the simulation with the relaxation values of the soundboard. Indeed, when the strings have been taken off, the soundboard displacement

has been measured. According to the measurement precision ( $\pm 0.5$  mm), the calculation results are with the same order of magnitude than the measurements.

The model allows a qualitative good adequation with the measurements; it will be useful to simulate the restoration and decide the best intervention.

### 2.3. Model application to the restoration

Once the model has been validated with the measurements, it's possible to simulate different restoration hypothesis. One of them is the addition of bracings (*gap spacers*) between the wrest plank and the upper belly rail. The restorer uses to add 3 bracings, uniformly spaced along the keyboard. Different configurations (space, number) were simulated to optimize the shear stress in the soundboard.

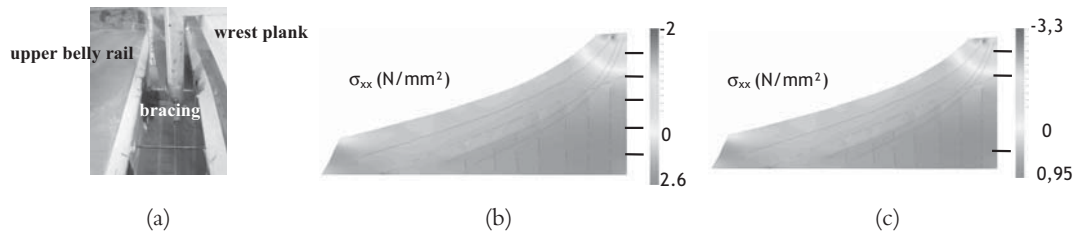

Fig. 2. Modelization of the addition of bracing (a), shear stress for 5 bracings(b) and for 3 (c).

Even if the absolute value of the shear stress is lower in the case of the addition of five bracings than in the case of three ones, the stress gradient is the lowest for 3 bracings. To prevent new cracks in the soundboard it's interesting to minimize this gradient. Finally, the model leads to advocate the addition of three bracings, but not spaced uniformly as the restorer is used to do. Indeed, 2 of the bracings are placed where the stress is the greatest (on the treble side) and only one on the bass side. This configuration allows the best minimization of the stress gradient along the soundboard.

## 3. Dynamical measurement

In addition to the fact that this harpsichord is a cultural heritage object, it's also a musical instrument with a sound function. The soundboard is one of the most important elements of the harpsichord in the sound production. Is it possible to detect cracks, or loading variations on the soundboard through vibrational analysis?

### 3.1. Impulse nearfield acoustical holography as a non destructive tool

#### 3.1.1. Principle

The acoustical holography is used to achieve a structural modal analysis. The NAH process of planar harmonic pressure fields is exhaustively described in [3], its adaptation for impulse source excitation (IPNAH) can be found in [4].

The impulse response of the vibrating source is measured in term of radiating acoustic field with a microphones array. The impulse response is obtained by a punctual shock excitation of the structure.

The vibration behaviour of the source is then deducted, in term of normal vibration velocity, with the help of an inverse calculation method based on spatial 2D Fourier transforms.

IPNAH has some interesting advantages, especially in case of fragile structures like cultural heritage musical instruments:

- except for the excitation system, it is a non contact method, which is not the case of the experimental modal analysis
- the number of shocks on the structure is less important than for laser vibrometry because an important number of measurement points (120) can be measured at the same time.

### 3.1.2. Experimental set-up

The impulse response of the harpsichord soundboard is measured in the semi-anechoic room of the Musée de la Musique (figure 4 (a)). In such a room, noise level is seriously diminished. This condition permits to minimize the soundboard excitation level and also to optimise the signal to noise ratio for evanescent waves.

The instrument under tension is analysed so the strings are muffled in order to eliminate the string sound production (figure 4(b)).

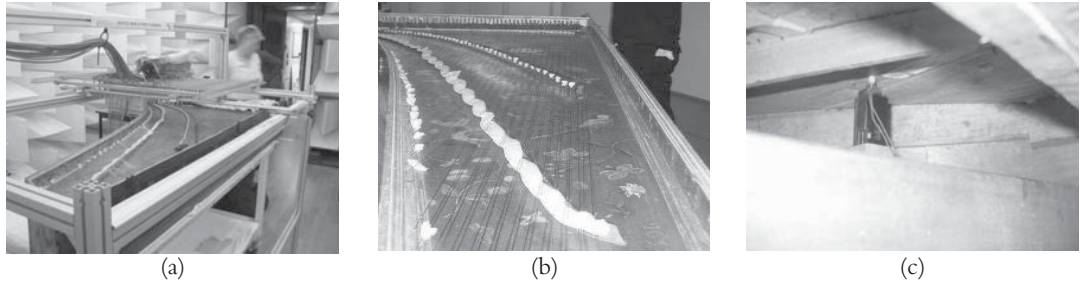

Fig. 3. NAH experimental set up: (a) holographic microphone array, (b) string muffing (c) impact hammer.

A harmonic acoustic nearfield is to be measured in order to be used in an NAH reconstruction process. This field is to be derived from an impulse response, which allows performing measurements in an ill conditioned acoustic environment ([4]). A point impulse excitation of the soundboard is provided by an automated hammer driven by an electromagnet that produces a reproducible shock (figure 4(c)). In the double objective of accessibility and painting conservation, the excitation position is chosen on the underside of the soundboard. The keyboard is therefore removed. The position of the impact is chosen so as to mobilize significant flexural vibration modes of the soundboard.

A 12 by 10 electret microphones array, with a 50 mm step, has been used to collect the pressure field. So as to fit the measurement grid, the array is moved into 8 positions. For each of these positions the array is also moved according to 16 interleaved positions so as to refine the measurement step grid to 12.5 mm. The 120 impulse pressure responses for each position of the array are collected using a home made 128 channels synchronous digital recorder. Each measurement associated to one shock on the soundboard has to be phase referenced. Therefore an accelerometer has been positioned on the soundboard and its constant impulse response is systematically recorded along with the acoustic signals. The resulting acoustic impulse response field is measured over a parallel plane at a distance  $z_h = 72$  mm. Even if this distance is the smaller possible here for technical reasons of accessibility, it is an unusually large distance for NAH. The field is finally sampled according to a thin grid with a 12.5 mm step and limited to a  $1162.5 \times 1762.5$  mm rectangle. The different sets of measurement finally count 13348 point acoustic impulse responses.

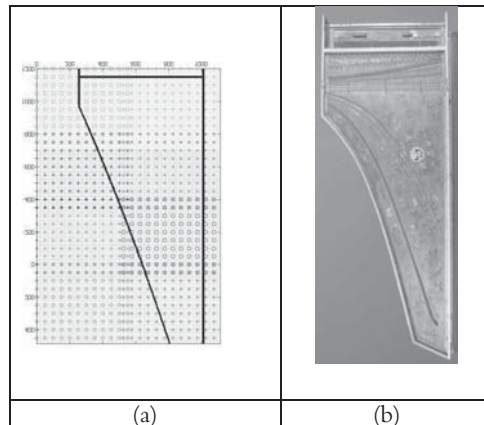

Fig. 4. Measurement grid.

### 3.1.3. Experimental results

The NAH process of planar harmonic pressure fields is exhaustively described in [3]. The velocity distribution is obtained by NAH inverse calculation on a virtual rectangular plane that contains the soundboard and has the same dimensions as the measurement plane. Mode shapes are presented in term of normal vibration velocity distribution on figure [6]. A particular attention is focused on the first modes.

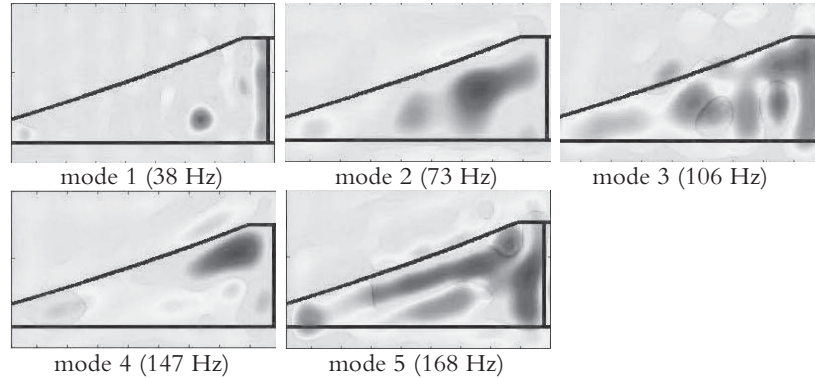

Fig. 5. First soundboard eigenmodes reconstructed with NAH inverse process.

### 3.2. Results analysis

This experiment allows improvement of the dynamical model. Indeed, the comparison with numerical results leads to change the limit conditions of the soundboard in the simulation. In the first model, the soundboard was embedded even along the wrest plank. The dynamic results give eigenmodes different enough in frequency and in shape. The limit conditions are modified along the wrest plank (free) and the results are given on the figure 7.

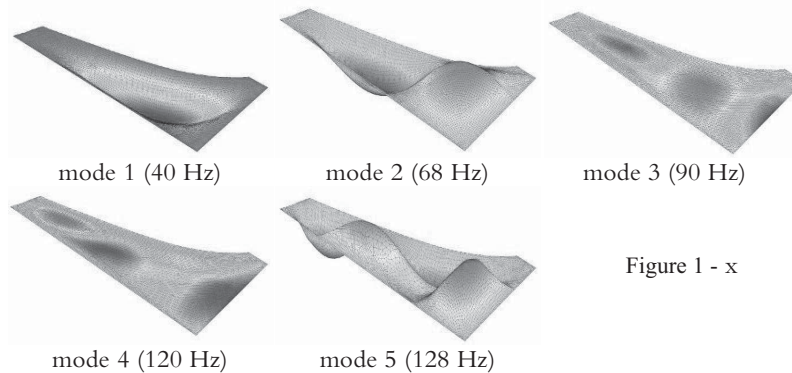

Figure 1 - x

Fig. 6. First soundboard eigenmodes reconstructed with NAH inverse process.

## 4. Conclusion

The modelization has been a tool first for testing the restoration options of this masterpiece. Static study allowed a minimization of the strain in the soundboard. As the harpsichord is also a sound object, we studied the dynamical behaviour of the soundboard, essential element in the sound production of a musical instrument. Experimental set up has been developed for this which presents the advantage to be



a non contact measurement. In addition to be a monitoring tool for the ageing of the structure, the experiment results allowed the improvement of the FEM. In the future, this measurement will be repeated to detect cracks or mechanical modification in the soundboard.

### References

1. Batoz, J.-L., Dhatt G. (1990): "Modélisation des structures par elements finis". Hermes.
2. Bucur, V. (2006): "Acoustics of wood". Springer second edition.
3. Williams, E.G. (1999): "Fourier Acoustics. Sound Radiation and Nearfield Acoustical Holography". Academic Press.
4. Ollivier, F., Alais, P., Karkaletsis, A. (2004): "Fast modal analysis by means of impulse acoustical holography". Proceedings of the 11th ICSV, pp. 2395-2402.

## WOODEN ART WORKS – LASER CLEANING CASE STUDIES

*Maria Lubryczyńska<sup>1</sup>, Joanna Czernichowska<sup>1</sup>, Izabela Uchman-Laskowska<sup>1</sup>, Krzysztof Chmielewski<sup>1</sup>,  
Magdalena Mazur<sup>1</sup>, Agnieszka Markowska<sup>1</sup>, Andrzej Koss<sup>2</sup>, Jan Marczak<sup>3</sup>, Marek Strzelec<sup>3</sup>*

<sup>1</sup> Faculty of Conservation and Restoration of Works of Art, Academy of Fine Arts in Warsaw, Poland

<sup>2</sup> Inter-Academy Institute for Conservation and Restoration of Works of Art, Academy of Fine Arts, Poland

<sup>3</sup> Institute of Optoelectronics, Military University of Technology, Warsaw, Poland  
mstrzelec@wat.edu.pl

### Abstract

Laser cleaning technique has been thoroughly compared to traditional chemical and mechanical procedures in the several case studies of wooden artworks, particularly when conventional cleaning tests showed that none of the methods known to experienced restorers met all the requirements. Laser cleaning appeared to be very successful in the removal of old overpaintings, dirt clusters, and sootiness formed by mixture of soot, wax, stearin and dust at coloured polychrome. Paper includes new results of investigations and earlier published works [1,2].

### 1. Introduction

Laser techniques are finding acceptance in conservation as advanced tools for cleaning artwork surfaces and analysis of artwork materials [3-6]. Optimally designed laser cleaning allows the removal of the external unwanted layers without damage to the underlying substrate.

In the case of wooden artworks, it must be ascertained that wood as a fragile organic material prone to thermal decomposition, will not be affected by that part of the laser beam energy which turns into heat while being absorbed by the layer material. Judging from earlier laser cleaning of metals and stones [7], one should find out first that wood cleaning is also a selective and self-limiting process [8]. Wooden artworks, often coated with different painting layers, can cause serious problems during conservation. Illustrative examples are polychromes, a type of pictorial artwork very abundant in the Europe. Cleaning and restoration in this case is aimed at the elimination of polymerized dirt, soot or carbonaceous deposits, other deposits built up from the environment and in some cases removal of overpaintings. This is not always possible with traditional methods based in the use of chemical solvents or scalpels, because of the porosity or fragility of the substrate and due to the difficulty to discriminate between the original surface and the unwanted layer. Laser cleaning is a dry and non-contact method potentially useful to complement other restoration approaches to this type of pictorial artwork [9].

In the following paragraphs laser cleaning technique is described and compared to traditional chemical and mechanical procedures in the case studies of different historical objects with wood as an original substrate material. In all cases, conservation treatments followed detailed structural stratigraphy of layers and identification of materials.

### 2. Overpaint removal on a gilded wooden bas-relief

The bas-relief presenting Saint Anna is the property of Diocesan Museum in Sandomierz, Poland. Probably, the object is a part of an altar from parish church in Nieznamierowice, Masovian Province (I-st decade of the 16<sup>th</sup> century). The iconographic type of the saint Anna relief is the composition of three figures: Saint Anna, Mary and Jesus. (Fig.1). The relief has a rectangular shape of height – 120 cm, width – 73.5 cm, ended at the top with semicircle. The figures form two iconographic groups: horizontal with Saint Anna and vertical with figures of the Holy Trinity. The canopy with fancy arranged curtains forms a background of the scene. Below the canopy we can see an angel head with opened wings. The composition illustrates the dual lineage of Christ – iconography of three figures (Saint Anna) and heavenly (Holy Trinity).

The wooden substrate (lime wood) is covered with a priming ground consisting of mixed chalk/glue deposition. The partially destroyed gilding is placed on almost the whole relief surface

on a special preparation (bolus alba) with binding media. Painting layers cover only the complexion and hair of figures. Some parts of bas-relief: background, curtains fragments, angel wings, scarf of Saint Anna, book, dove, cushion and floor are covered with dark secondary layer. Detailed inspection detected gold foil below the layer, which can be a darkening old attempt to the former reconstruction of the original gilt. Investigations do not exclude that losses of gold gilding were in the past filled up with silver flakes and covered with varnish, which was a kind of gold imitation. The influence of hydrogen sulfide from the surrounding air caused formation of dark sulfides. The stratigraphic analysis of selected parts of object can be found in [2].



Fig. 1. Bas relief of Saint Anna before conservation

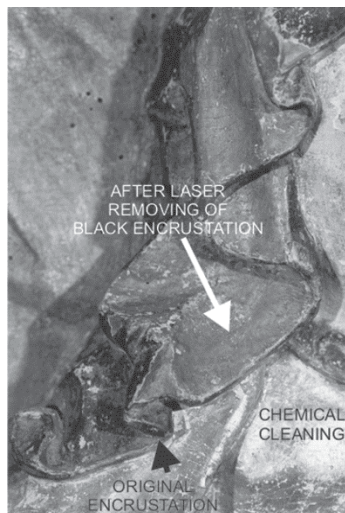

Fig. 2. Photograph shows the results of laser removing of dark encrustation in comparison with parts cleaned with organic solvents.

The main problem during the conservation of the presented wooden art object was connected with the selection of the appropriate technology to remove the dark layer described in the previous paragraph. The layer was resistant to several solvents used, which in turn influenced underlying gold remains.

Much better results have been obtained during preliminary trials of laser cleaning. Utilization of Nd:YAG, Q-switched laser Model RENOVALaser1 with carefully selected fluence allowed to remove the whole dark, secondary layer without destroying the primary ground (Figure 3). RENOVALaser1 device was equipped with an optical fibre delivery system (0,22 NA) without any optical focusing subassembly. It allowed the precise control of fluence depending on the distance of fibre to the object, with typical fluence value slightly below  $0,5 \text{ J/cm}^2$ . No influence on “bolus alba” and gilding has been observed. As it can be seen from Fig. 2, paint brush traces on primary ground were also preserved. Inside hollows, the encrustation was thicker and more firmly joined with substrate. The controlled increase of laser fluence to appr.  $0,7 - 1,0 \text{ J/cm}^2$  allowed to obtain the completely clean area.

### 3. Laser cleaning of wooden ceiling polychrome of the 16<sup>th</sup> century church

St. Stanisław the Bishop’s wooden church in Boguszyce, near Rawa Mazowiecka was built in 1558 thanks to Wojciech Boguski foundation and it is now a gem of wooden sacral architecture in Poland. Illusionistic painting decorations – polychrome, were made during the church erection (1558 – 1569), with the use of a technique of egg distemper on a very thin chalk/glue linewash substrate, by a few artists, mainly by Jan Jantes who was a painter and sculptor from Warsaw. The ceiling polychrome is an imitation of coffered ceiling consisting of round, octagonal, and quadrilateral coffers with connecting them longitudinal elements. In the spaces between the coffers

there are plants decorations, i.e., rosette of leaves, flowers, and fruits, human figures, grotesques, arabesques, and drolleries. Painting decoration of walls is an imitation of an interior of a brick temple with rich architectural details and monumental wall paintings.



Fig. 4. Laser cleaning tests. Photo 1) shows comparison of removal of secondary encrustations from a polychrome: a) chemical agents, b) laser, and c) original surface.



Fig. 3. Tests of polychrome laser cleaning: left side – Maria Lubryczynska (main work performer).

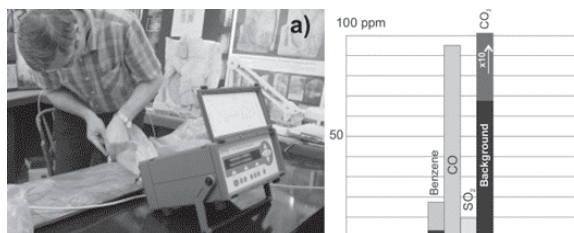

Fig. 5. Measurement of concentration of selected gases generated during laser cleaning of wood with polychrome: a) Innova photo-acoustic system during tests, b) results of measurements.

The most difficult problem for conservators in religious monuments was removal of strong dirt and sootiness (a mixture of soot, wax, stearin, and dust) of the polychrome [11]. Typical chemical method, usually used for cleaning of dirt polychrome, was based on surface active cleaners containing water. Its application for cleaning of Boguszyce's polychrome turned out to be completely insufficient and hazardous for the paintings [12]. It was mainly because of the fact that minimal thickness of a mortar was comparable with encrustations thickness. Also cleaning with surface active agents was not satisfactory as far as aesthetic results were concerned. Further trials to clean the painting caused damages of convex parts of the polychrome. It was decided to apply laser method of cleaning.

Utilization of Q-switched Nd:YAG RENOVALaser 1 system [2], with carefully selected fluence allowed to remove the whole dark, secondary layer without destroying the original substrate (Fig. 4). RENOVALaser 1 device is equipped with an optical fibre delivery system, which also in this case has been not equipped with optical focusing subassembly. It allowed the utilization of so called "top hat" distribution of output energy and precise control of fluency depending on the distance of fibre to the object.

As it has been earlier found during measurements of concentration of gases generated during laser cleaning of art works, treatment of wood is one of the most dangerous [10]. It was confirmed also during laboratory tests with pieces of wood with polychrome from Boguszyce. Particularly big concentrations of CO, SO<sub>2</sub> and benzene have been measured (Fig. 5).

#### 4. Medieval polychromed wooden sculpture of madonna and child

Polychromed wooden sculpture of Madonna and Child belongs to the collection of sacral sculptures of Diocesan Museum "Dlugosz House" in Sandomierz, Poland (Fig.7).

Sculpture height of 1 m and plane development of its back side indicated original arrangement in altarpiece. Stylistic analysis, based on the characteristic configuration of figure fragments allowed to date its origin at the decline of 15<sup>th</sup> or beginning of 16<sup>th</sup> century and to localize studio in Lesser

Poland. More detailed determination of Madonna's provenance was impossible due to a very bad sculpture condition – losses of sculptural form, face damages and seizure of details, usually characterizing medieval art origin.

Damages and strong soil included all technological layers: linden wood, chalk–glue ground, red clay, silver and polychrome. Cleaned surface was fractured and it was composed of many concave, bowl shaped flakes. This fact made cleaning substantially difficult as well as it forced minimization of solvent treatment. Selection of laser as a complementary cleaning tool for presented wooden sculpture was the best, characterized also by the smallest interference into the original object structure.



Fig. 7. Photograph of Madonna and Child before conservation.



Fig. 6. Results of chemical cleaning: a) tests performed at Child's face and trunk, Madonna's hand, neck and coat (rectangles); b) overall view after chemical cleaning.



Fig. 8. a) after chemical removal of overpaintings; b) laser cleaning tests (fairs).

Conservation started with chemical investigations, aimed at determination of sculpture technological structure. It included pigments and binders analyses in samples of color layers and determination of quantity and stratigraphy of technological layers. All representative results can be found in [1]. Stratigraphic and identification analyses were supplemented by dendrology studies as well as X-ray and UV light imaging. Conducted studies confirmed a lack of original sculpture's polychrome. Fragments of painting layers at Madonna's coat, dress, and both complexions were made using oil technique. Identified pigments (Prussian Blue with lead white, lead white with vermilion, lead white with barium white) gave the evidence of painting layers origin as no earlier than 19<sup>th</sup> century.

Sculpture has been made of linden wood and sized using glutoline glue. The whole sculpture surface, except a reverse side, was covered with glue–chalk ground. Red bole layer was spread at a dress and at an external side of a coat. A small fragment of silver, found in Madonna's dress hollow, indicated original dress's silver plating.

Taking into account overall bad preservation of figure sculptural form and polychrome, main restoration assumption included complete sculpture clearance, removal of partially preserved oil overpaintings, and rebuilding/completion of sculptural form.

Chemical cleaning with solvents was preceded by careful resistance tests of painting layers (Fig.6a). Fragmentarily preserved, contrast planes of oil overpaintings, observed after cleaning of soil, had negative influence on the artwork perception. It can be seen in Figure 6b. Color interference created the contrasts, which improperly directed observer's attention. It was considered, that better solution would be presentation of the sculpture with preserved layers of ground and bole together with uncovered wooden fragments. Layers of oil overpaintings were removed using chemical methods with subsequent thorough mechanical scalpel cleaning of individual sculpture parts. As it was stated earlier, red bole layer coated with oil overpaintings was moisture-sensitive and easy to elute during dirt removal. Oil paint layers on bole were cleaned mainly using scalpels. It allowed to uncover the preserved silver fragments under white overpainting and red lead layers. Figure 8a shows view of Madonna and Child figure after chemical removal of overpaintings. Tests of laser cleaning around faces and at red bole are presented in Figure 8b.

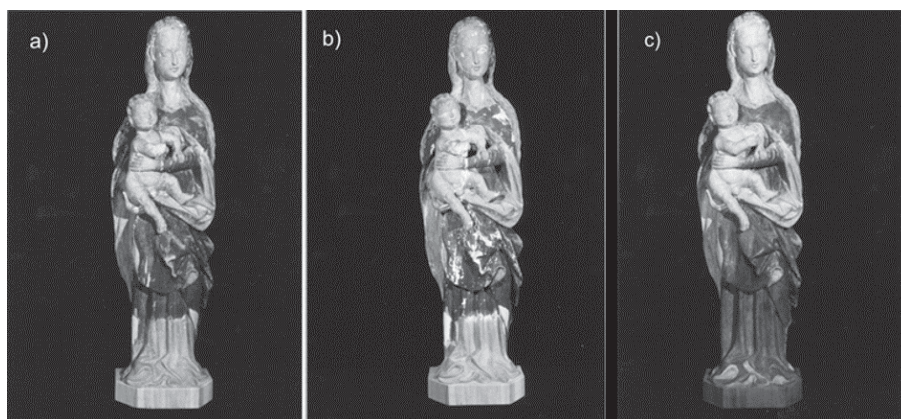

Fig. 9. Sculpture after laser renovation and reconstruction (a); after completion of mortar and pulment layers (b); final view of Madonna and Child wooden sculpture after restoration process c).

Laser renovation proved to be very precise and uniform, and has been applied to clean the wooden substrate, ground and red bole layers. The laser used in the procedure of cleaning was a Q-switched Nd:YAG system ReNOVALaser2 [13], equipped with a pantograph and beam focusing assembly. Typical average fluence was kept below  $0.350 \text{ J/cm}^2$ . This lower value of working fluence was more safe in case of worse state of preservation of the remains original polychrome in comparison with objects presented in Chapter 3 and 4. Laser cleaning finally integrated artwork surface. Final stage of conservation included completion of ground and red bole layers at recovered wooden surfaces, reconstruction of small Madonna's and Child's face fragments as well as ultimate retouch of whole surface, presented in Fig.9c.

## 5. Statue of the virgin mary with child

The figure of the Virgin Mary with Child, sculptured in linden tree and covered with tempera polychrome by unknown artist in 16<sup>th</sup> century, belongs to a private collection. The main conservation problem was connected with cleaning of several sculpture areas, particularly Virgin Mary coat. Old blue overpainting deeply penetrated wood structure and cavities. As in the previous cases, ineffective was chemical cleaning as well as mechanical scalpel treatment. Figure 10 illustrates results of laser cleaning.



Fig. 10. Figure (left side) and a coat fragment after laser cleaning (right side).



Fig. 11. Virgin Mary with Child before (left) and after full renovation (right side).

Laser removal of secondary layers was not only fast, but also safe for wood fibers structure, without any mechanical damage confirmed by SEM analyses of Madonna's coat microsections before and after laser cleaning procedure. Photographs of the Virgin Mary with Child sculpture before, and after conservation are shown in Figure 11.

## 6. Wooden rosettes

Eighteen rosettes, sculptured in lime tree, replaced centuries ago part of eighty original but damaged stone rosettes in a beautiful décor of Sigismund Chapel dome at Wawel Castle in Cracow (Figure 12).

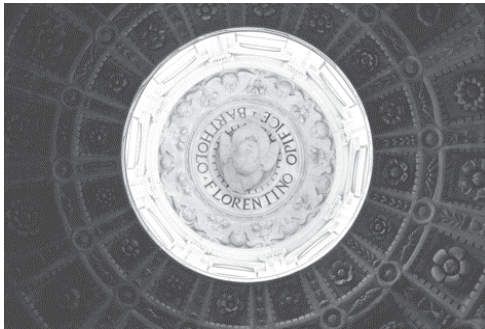

Fig. 12. Stone rosettes at the dome of Sigismund Chapel, Wawel Castle in Krakow.

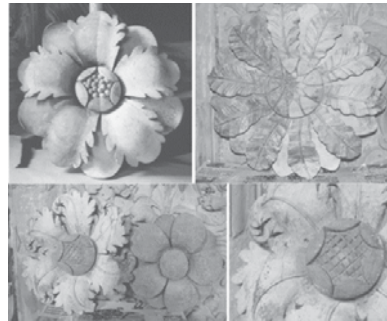

Fig. 13. Different rosettes during laser cleaning.

Color integration of sculptures with grey-green sandstone walls was attained through coating of wood with several paint layers, covered in the next years with crust of dirt/environmental pollutants as well as partially damaged due to the influence of temperature/humidity changes. Total removal of encrustation before the new conservation procedure was possible only with the use of lasers. Treatment was fast, efficient and safe for objects.

## 7. Conclusions

In conclusion, the use of laser for presented wooden artworks was the best and only one solution, characterized also by the smallest interference into the original object structure. The additional

advantages of laser cleaning are: the lack of hazardous chemicals during the process and the short time of renovation.

### Acknowledgements

Work has been partially supported by the Ministry of Science and Higher Education, Poland, projects: 217/E-284/SPUB-M/EUREKA/T-11/DZ 203/2001-2003, and 120/E-410/SPB/EUREKA/KG/DWM 97/2005-2007.

Substantial parts of this review are based on post-doctoral thesis (M. Lubryczyńska) and master's degree theses (M. Mazur, A. Markowska).

### References

1. Chmielewski, K. et al. (2007): Conservation of medieval polychromed wooden sculpture of Madonna and Child. In: Marta Castillejo (ed.) "Lasers in the Conservation of Artworks" LACONA VII Proc., Madrid, Spain, Sept. 17-21, 2007, A.A. Balkema Publishers, in print.
2. Strzelec, M. et al. (2005): Overpaint removal on a gilded wooden bas-relief using a Nd:YAG laser at 1.064  $\mu\text{m}$ . In: Klaus Dickmann, Costas Fotakis, John Asmus, (eds.) "Lasers in the Conservation of Artworks", LACONA V Proc., Osnabrueck, Germany, Sept. 15-18, 2003, Series: Springer Proceedings in Physics, 100, 133-138.
3. Cooper, M. (ed.) (1998): "Laser in Conservation: An Introduction", Butterworth Heineman, Oxford.
4. Fotakis, C. et al. (1997): Laser technology in art conservation. In: A.C. Tam (ed.): "OSA TOPS on Lasers and Optics for Manufacturing, 9", Optical Society of America, Washington, D.C., 99
5. Salimbeni, R. (ed.) (2000): "Lasers in the Conservation of Artworks". LACONA III Proc., J. Cult. Herit. 1 (Suppl. 1).
6. Koss, A., Marczak, J. (2005): "Application of lasers in conservation of monuments and works of art". Scientific Reports IAICR. ISBN 83-922954-0-4. Warsaw.
7. Marczak, J. et al. (2005): Laser cleaning of the interior stone decoration of King Sigismund's Chapel at Wawel Castle in Cracow. Proc. SPIE. vol. 5958, 595808.
8. Wiedemann, G. et al. (2000): Laser cleaning applied in the restoration of a medieval wooden panel chamber at Pirna. J. Cult. Heritage 1, S247-S258.
9. Castillejo, M. et al. (2003): Effect of wavelength on the laser cleaning of polychromes on wood. J. Cult. Heritage 4, 243-249.
10. Strzelec, M. et al. (2003): Preliminary optoacoustic measurements of air pollution generated during laser cleaning of artworks. In: Renzo Salimbeni (ed.): "Optical Metrology for Arts and Multimedia", Proc. SPIE, 5146, 210.
11. Theodorakopoulos, C., Zafiropoulos, V. (2005): Laser cleaning applications for religious objects. European Journal of Science and Theology, 1, 63-76.
12. Phenix, A., Sutherland, K. (2001): The cleaning of paintings: effect of organic solvents on oil paint films. Reviews in Conservation, 2, 47-59.
13. <[http://http://alpha1.infim.ro/cost/](http://alpha1.infim.ro/cost/)>. COST G7 action Website. Subpage "Summary of laser cleaning systems."





## **SCIENTIFIC VISIT, SAN MARCO MUSEUM**



## MONUMENTAL BUILDINGS AND CONSERVATION PROBLEMS: A COMPLEX APPROACH

*Magnolia Scudieri*

Director of the San Marco Museum, Florence  
scudieri@polomuseale.firenze.it

A museum director has always to deal with problems concerning both the preservation of the works of art and various conflicting needs such as the respect for the ideal parameters and standards of good preservation of the artworks, the specific environmental conditions of the museum, the financial situation and the requirements of the public.

All these necessities play an important role and therefore a museum director should always try to find a balance among them. In the middle there are the works of art and their context.

On the one hand there are the scientific ideal criteria regarding the parameters for a good preservation of the artworks (that's to say light, temperature, humidity, pollution); then we have standard scientific instruments to measure these parameters, but it also exists a series of technical equipment for monitoring, correcting and improving the environmental conditions.

With reference to the good working of these instruments and equipment we have to deal with the following problems:

1. the costs of the equipment
2. the adaptation to the architectural environment
3. the ordinary repairs and running of the equipment, the data reading and collection, which are both connected to the problems regarding the staff of people able to check the working and the results of this equipment.

On the other hand it exists, however, the specific reality of the museum with its own peculiar identity, which is very different from place to place, and its own monumental character, on which we must intervene with extreme caution.

The respect for the architectural building is so important as the respect for the artworks housed inside the building itself.

Finally it exists the public of visitors with their necessities that, in the last years, are considerably increased in quantity, quality and typology. In the last fifty years we have been faced with a general increase in the number of visitors, but also with an increase in the concentration of the visits due to the numerous organized tourist groups and to the short time of their permanence inside the museum.

This new situation has provoked as immediate consequence some alterations of the microclimate.

Moreover, it has increased the demand for "special visits", in which people are allowed to stay for a long time in front of the work of art because of teaching and research reasons. This demand is linked both to the need of improving the legibility of the artworks in their details and to the possibility of observing the work close up with a good amount of light.

Finally it has increased the demand for sending the works of art abroad, on the occasion of some exhibition organized all over the world, because the artworks have become in the last few years a sort of "ambassadors" of the history and culture of our country.

During the exhibitions the works of art are set in places and buildings with conditions of microclimate, light and safeness, which, even if included into a range of values considered compatible, are often very different from those ones of their seat of origin, where they are usually housed. On the occasion of an exhibition, we must sometimes reject the "ideal" exhibition proposal made by the host museum. Therefore we have to find both other ways of sending the works abroad and different exhibition solutions in order to alter as little as possible the usual conditions in which the artworks are set in their museum of origin.

Some countries, especially if they have a recent museum tradition, have sometimes some difficulties in understanding this situation.

Nevertheless, in order to limit "the stress" on the works of art and to make a more precise valuation of the risks, it is necessary to extend and improve our knowledge concerning the nature

of the artwork materials, their level of alteration in proportion to their ageing process and their capability to react to the environment solicitations.

Although it is important to understand what it occurs in the environment in relation to the variations in the base parameters, first of all we should try to define and measure this stress.

In this general context, in which we always try to find a balance between the concepts of “preservation” and “valorisation”, San Marco Museum represents an emblematic example, gathering in itself all the problems mentioned above.

It is also known as the Museum of Fra’ Angelico, because it houses the majority of the works of art painted by this artist, who is considered to be one of the most important Renaissance painters.

In the museum there are especially frescoes, but also many paintings on wood and illuminated manuscripts carried out by Fra’ Angelico. The peculiarity is that one part of the works of art here preserved, the frescoes, but also some panel paintings come from this place, from this old monastery and from the church of San Marco, situated next to the Museum. Therefore they can be seen in their original seat, that is to say in the old monastery of San Marco, now converted into a state Museum, which was re-built from 1437 to 1444 for the Observant Dominican Friars coming from san Domenico in Fiesole. Among these friars there was also fra Angelico.

The monastery was re-built on the ruins of an old medieval building, originally inhabited by another monastic order: the Sylvestrins.

It was rebuilt in beautiful Renaissance architectural structures by Michelozzo, who was Cosimo dei Medici’s favourite architect and sculptor. Cosimo de’ Medici and his brother Lorenzo financed the restoration of the building, which is still intact.

At that time it represented a modern architectural example according the criteria of functionality and rationality followed by Michelozzo.

It was declared National Monument and became a state museum in 1869, soon after the suppression of monasteries and convents.

Fortunately it didn’t suffer the “offence” of improper use and it became immediately the Museum in which the illustrious memories of the Dominican Orders are still kept and preserved.

Around 1920 it was decided to collect in the Museum almost all the paintings on wood carried out in Florence and its surroundings by Beato Angelico.

Therefore it was possible to create a monographic section of the museum, which has its own seat here, under the vaults of the old Pilgrim’s Hospice. This place is fascinating and the possibility to see 24 paintings all together, which show us the art of a painter throughout the time, represents an absolute privilege both for the visitor and the scholar.

Nevertheless this fascination has some costs related to the necessity to improve the technical equipment and functionality as well as the use of the museum, because if we want to avoid or reduce the invasive interventions on the building structure, then every innovation should be limited to the bare minimum.

For example, one of the most fascinating elements of this museum, but also one of the most problematic, is the continuous passage from the exterior to the interior, from the courtyards to the museum rooms, and it represents a problem of no easy solution concerning the preservation of the artworks.

The hospice has two old doors opening onto a courtyard; on the one hand they are necessary to ventilate the room, but on the other hand they represent a problem for its microclimate. Taking into account the results of the environment monitoring, which is executed since a long time, and after careful consideration, it arises the necessity to extend and improve the knowledge of the state of preservation of the paintings, even if they don’t show significant traces of stress.

It is important, in fact, to understand the level of suffering or adaptation to the situation and to find the more suitable solutions. This aim can be achieved only through an interdisciplinary collaboration with the universities and the research institutes, which are specialized in the study of the different materials, of the microclimate and in the preservation of the artworks as well.

As far as the room of the Pilgrims’ Hospice is concerned, it has been decided, first of all, to analyse both the wooden supports of the 15th – century-paintings on wood, that it houses, and there behaviour in relation to the environment solicitations. This kind of analysis has been carried out by the Department of “Scienze e Tecnologie Ambientali Forestali” of the University of Florence with the supervision of Prof. Luca Uzielli.

I hope it’s only the beginning of a long way together.

# MONITORING CLIMATE AND DEFORMATION OF PANEL PAINTINGS IN SAN MARCO (FLORENCE) AND OTHER MUSEUMS

Paolo Dionisi-Vici, Ilaria Bucciardini, Marco Fioravanti, Luca Uzielli

DEISTAF, University of Florence, Italy  
pdv64@inwind.it

## Abstract

This paper briefly describes selected past and ongoing researches carried out by the Authors at DEISTAF - University of Florence, in the field of monitoring deformations of Panel Paintings exhibited in important Museums and Historical Buildings - mostly in Florence -, related to the variations of microclimatic conditions. From actual deformations, behavior and sensitivity of wooden supports may be studied, mathematical models can be calibrated, and stresses can be evaluated. A self-powered concept-apparatus named "Deformometric Kit" is also described, which was developed at DEISTAF in order to log during long periods the climate and the deformative behavior of the panels, or the forces acting on them, as in the Mona Lisa case. Some initial data and results from Deformometric Kits installed on two mock-panels placed in a room of the San Marco Museum are also described.

## 1. Introduction

During the last fifteen years the senior Authors developed several collaborations with Institutions taking care of important artworks painted on wooden support, dealing specifically, among other subjects, with the interactions between microclimate variations and conservation of the artworks.

Due to the large amount of WCHOs (Wooden Cultural Heritage Objects), Florence probably had the best conditions to start this kind of monitoring, and this approach found a rapid diffusion abroad because of the quality of the information it can provide, both theoretical and practical.

This paper briefly describes some of the case-studies with which the Authors dealt, and that can be useful to display the flexibility of the approach, highlighting that the deformative geometry of the monitoring apparatus must be chosen as a function of the desired type of response.

## 2. Case studies

### 2.1. Collaborations with Museums, in Florence

Usually the measurements were designed on the basis of specific questions asked by Restorers and Conservators, but these experimental also contribute to building up a useful database for modelling the behaviour of these precious objects.

According to this synthetic approach, here are described some of the case-studies carried on in Florence:

- the *Uffizi Museum* [1], where monitoring was carried on Giotto's *Maestà di Ognissanti* (~ 1303) (see Fig. 1), and on Alessio Baldovinetti's *Madonna con Bambino e Santi* (~ 1454); the structure of the laminated wood shield on which Caravaggio painted his *Medusa* (1547), was also thoroughly analyzed, by means of Computed Tomography [4] (see Fig.3);
- the *Argenti Museum*, in Palazzo Pitti, where microclimatic cases monitoring was required for a better comprehension of the interactions between the microclimate and the materials used in the cases;
- the *Opificio delle Pietre Dure* [2], where the discussions about the choices to be made for restoration and conservation started from very practical problems that the restorers wanted to solve;
- the *Orsanmichele Church* [3], under the Special Superintendence of the Florentine Museums Pole, where the monitoring of Bernardo Daddi's *Madonna con Bambino e Angeli* (1347) is still going on after more than seven years (see Fig. 2);
- the *Bardini Museum*: the monitoring on a precious wooden shield is going on, based on the past experience on the above mentioned Caravaggio's *Medusa* (see Fig. 3);

- the *San Marco Museum*, first results of which will be discussed in a specific paragraph.

## 2.2. Collaborations with Museums, out of Florence

- the *Accademia Museum* in Venice: a painting by Vittore Carpaccio, *L'incontro di Gioacchino e Anna* (1515), had to be freed from its modern iron cross-beams system (that produced many conservation problems on the paint layer) and the conservator needed to have informations about the reactivity of the support to the climate variations in order to design the stiffness of the new cross-beams;
- the *Louvre Museum* [5], in Paris: a group, led by Joseph Gril, was formed to answer several questions, originating from the transfer of Leonardo da Vinci's *Mona Lisa* (1503-1516) from the old to the new display case; the questions included (a) if the actual thermo-hygrometric conditions of the display case could be improved, for the well-being of the artwork, (b) an evaluation of the sensitivity of its wooden support to microclimatic variations, and (c) the risk of propagation of a crack present since a very long time on the upper part of the painting. For this study, carried out in cooperation with several other Colleagues, a measurement apparatus was designed and implemented, allowing – among others – for the monitoring of both deformation at mid-height of the support and of forces acting between one of the cross-beams and the two upper corners of the support.

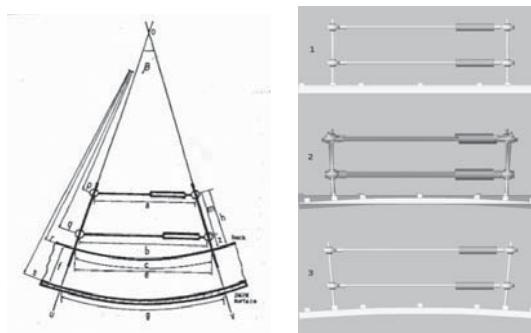

Fig. 1. The “Giotto” system: (left) its geometry; (right) the way it works.

## 3. Instrumentation

In 1992, for the monitoring of Giotto's *Maestà di Ognissanti*, a measurement geometry (developed specifically for panel paintings) was implemented. Two parallel displacement transducers were mounted on the back of the panel, at different distances from the panel's surface, in direction perpendicular to the grain (see Fig. 1); based on simple geometric relationships, and assuming that the cupping deformation can be schematized as an arc of a circle, the combined data from the two transducers allow to compute/estimate both the contraction/expansion of the panel in its “plane”, and its cupping radius of curvature. If the exact geometry of the system is known, absolute measurements and not just only variations can be computed.

In these first applications the system couldn't be self-powered, because of the significant power consumption of the LVDT transducers and of the logging system.

Starting from 1999 a simpler apparatus was developed, using a commercial self-powered data-logger and potentiometric displacement transducers being powered by the same data-logger only at intervals, when measurements were recorded, typically at 15 minutes interval; such system was applied for the first time on the Daddi's painting, in the church of Orsanmichele (see Fig. 2), and is still used. The system required a cable connection to download the recorded data.

In 2006 Lucchetti and Dionisi-Vici [6] patented a self-powered system with very low consumption, equipped with a Bluetooth antenna, allowing a frequent download or verification of the recorded data, without any need for physical cable connection; it is especially useful when the logger is located in locations hard to be reached or in a sealed case, since no opening is required.

This system is presently installed on the back of the *Mona Lisa*, since November 2007.

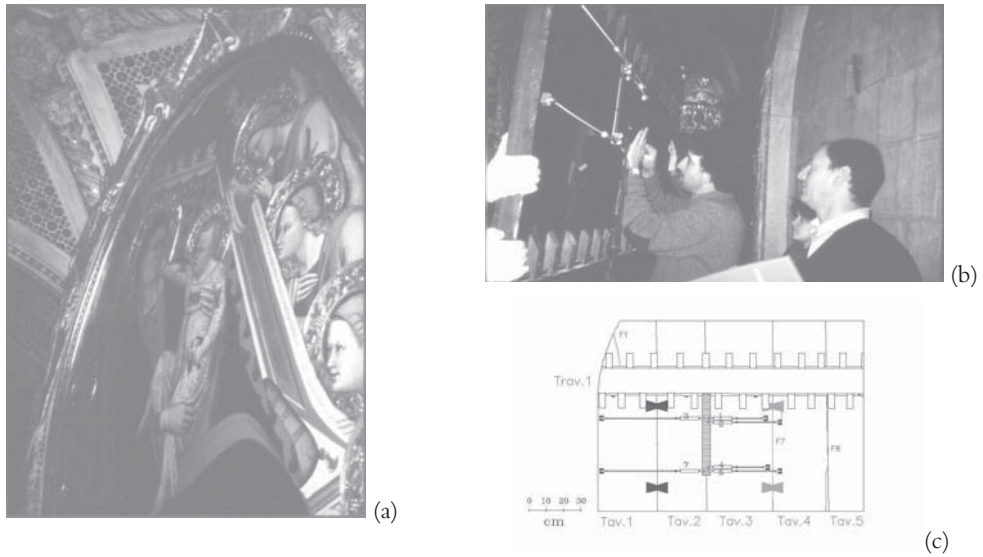

Fig. 2. (a) Daddi's *Madonna con Bambino e Angeli* (1347); (b) fixing in place the system of transducers; (c) schematic drawing of a part of the wooden support (seen from the rear face), and of the six deformation transducers applied on it, measuring only in-plane deformations.

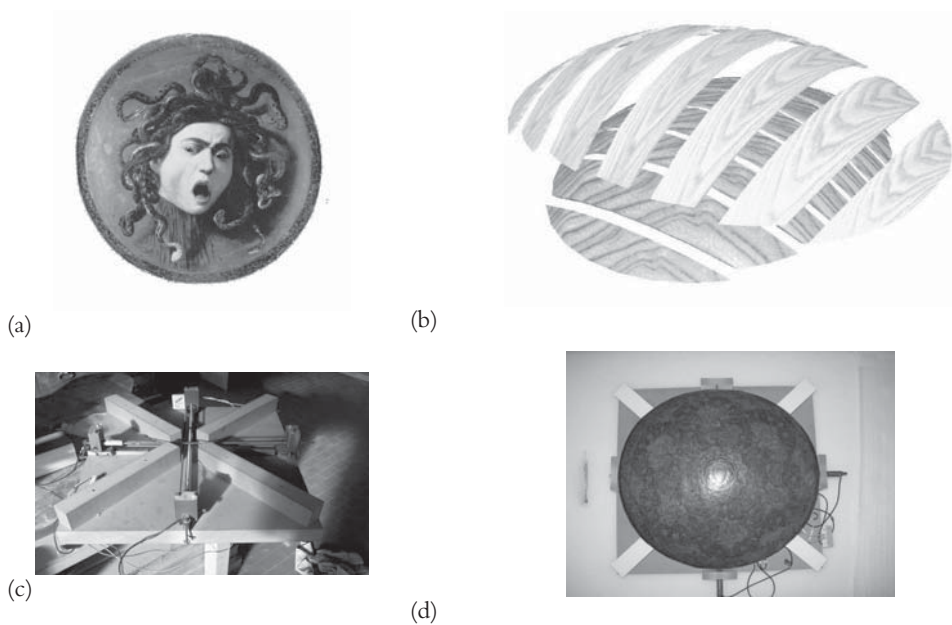

Fig. 3. a) the Medusa shield by Caravaggio; b) the virtual reconstruction of the wooden hidden structure; c) the support for the measurement setup; d) the measurement system applied on the Bardini Museum's shield



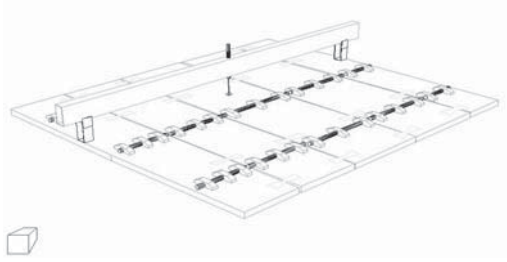

Fig. 4. Schematic drawing of the wooden support of Carpaccio's *L'incontro di Gioacchino e Anna* (1515), with its old metal cross-beams, during the measurement of its transversal profile.

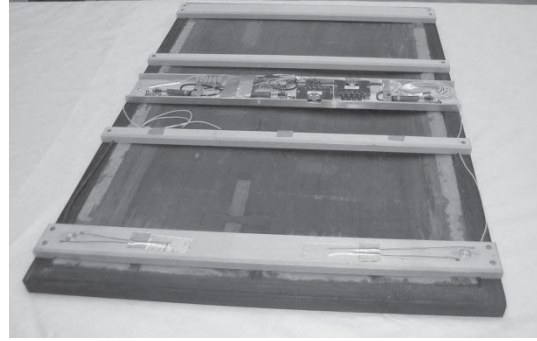

Fig. 5. The back face of Leonardo da Vinci's *Mona Lisa* (1503-1516), with the monitoring instrumentation installed. In the foreground (top of the painting) the cross-beam measuring the force acting on the panel; in the middle, the aluminium support carrying the displacement transducers and the data-loggers.

#### 4. San Marco monitoring and initial data analysis

In cooperation with Dr. Magnolia Scudieri, the Director of San Marco Museum in Florence, a monitoring of the deformations of an original panel painting (the *Trittico di San Pietro* by fra' Giovanni Angelico, located in the *Sala dell'Ospizio*, the very room where this presentation has been given) is being planned. The knowledge of sensitivity and movements of the wooden support are anticipated to be most useful when the panel will undergo restoration, possibly in a few years.

While waiting for the original panel to be available, two mock-models of its wooden support have been designed, assembled, and located in the same room, in order to have available reference data from physical models of the original panel. As compared to the original (28-30 mm), the two mock-models have the same thickness (30 mm), are smaller in size (300 x 300 mm) but are expected to react and deform in the same way, and are equipped with the same instrumentation (one data-logger and two potentiometric transducers each); they only differ from each other because of the wood from which they are made: both are made of Poplar (*Populus alba* L.) as the original, but one (the "New": N) comes from a board sawn and seasoned since only a few years (possibly 5-7), whereas the other (the "Old": V – formed by two half boards glued along an edge, parallel to the grain) comes from an artwork (possibly a shelf) old over 150 years, kindly provided by the Uffizi's restoration laboratory.

Both mock panels have been vapour-proofed with aluminium foil on the front face, simulating a protective varnish, and on the four edges to eliminate the border effects.

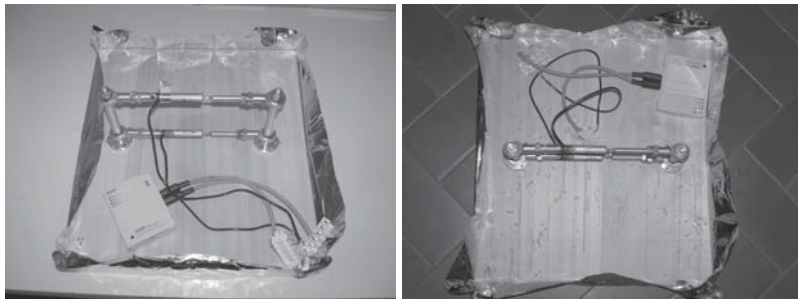

Fig. 6. The two mock-panel made of Poplar (*Populus alba*) wood, both are 300x300x30 mm in size, and have been vapour-proofed with glued aluminium foil on the front face and on the four edges. The N panel is made with "new" wood, the V panel with "Old" wood (over 150 years). The mechanical assembly, the ball joints allowing for self-adjustment during deformation, the blue transducers, and the data-loggers with their electrical connections, are clearly visible.

The mock-panels were put in two different locations in the *Sala dell'Ospizio*, (the “N” panel near a door facing the external open-air cloister, the “V” panel away from the drift’s impact) and each of the two loggers monitored for the respective panel both the microclimate (Temperature and Relative Humidity of the surrounding air) and the deformations measured by the two transducers. For data analysis the wood EMC (Equilibrium Moisture Content, derived from T and RH values) was adopted as a synthetic parameter to describe the microclimate. It should be emphasized that such EMC is not the actual MC (Moisture Content) of the wood, but just the equilibrium value towards which the wood’s external layer tends, and that the whole board could approximately reach, if the climate remained identical during a sufficiently long time (approximately 2 months, for that thickness of Poplar wood).

Some initial results from the monitored data are shown in Fig. 7 and Fig. 8. At a first glance, the behaviour of the two panels is quite similar, although some individual differences become more evident at a deeper examination. The comparison with the original painting, exposed to the same climatic variations, will be of the utmost interest.

The processing and analysis of collected data is under way, in cooperation with the LGMC equipe, from Montpellier.

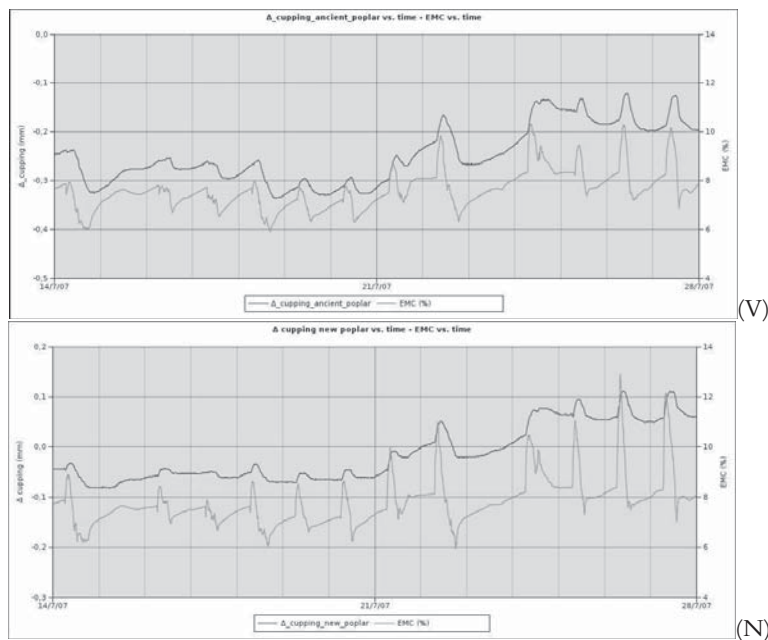

Fig. 7. Some initial results obtained from processing the recorded data. Purple lines indicate the variation in time of the EMC (%) of the surrounding air (scale on the right), blue lines variation of the camber (mm) of the cupping of the board. – A few comments: the daily variation of the climate is clearly visible in all graphs; variation of air EMC is very similar for both locations, although the one in front of the door shows larger excursions (distance between the two locations is approximately 10 m); deformation reacts promptly to climatic variations; the deformations of the “V” panel are larger, although it is located far from the door.

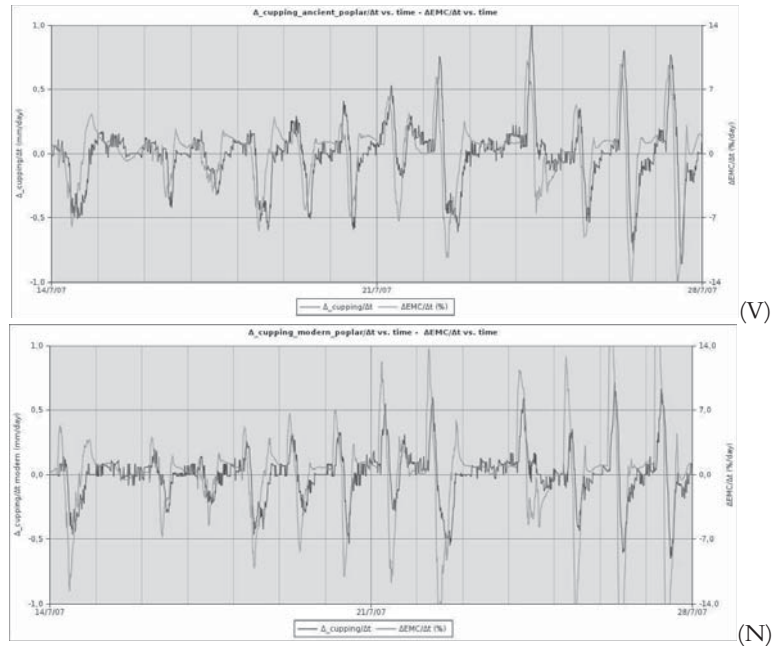

Fig. 8. Some more initial results obtained from processing the recorded data. Purple lines indicate the *instantaneous* variation in time of the EMC ( $\Delta\%/ \Delta t$ ) – with  $\Delta t$  very small – of the surrounding air (scale on the right), blue lines indicate the *instantaneous* variation of the camber ( $\Delta\text{mm}/\Delta t$ ) of the cupping of the board. Though the response between the two panels is not significantly different, the ancient panel shows a more nervous variation to smaller humidity variations in comparison with the modern one.

## 5. Conclusions

All WCHOs differ one from each other for many reasons, including their physical-mechanical peculiarities, state of conservation, and past climatic history. Evaluating their individual sensitivity to actual exhibiting or storage conditions can provide a very useful support for decisions which need to be made for their optimal conservation, whereas the adoption of “standardized” criteria can be misleading and can lead to further conservation problems, even when storage or exhibition takes place in a climate controlled case.

Monitoring of deformations of wooden supports, in parallel to the climatic conditions producing them, can give useful information for the best understanding of unique artworks, and can provide to the conservators objective criteria for choosing the best environmental conditions.

## References

1. Uzielli L., Fioravanti M., Casazza O., Perucca G. (1992): “A technique for double-sided monitoring the deformations of the wooden supports of panel paintings: the experience of Giotto's ‘Maestà di Ognissant’”. Proc. 3rd Intern. Conference “ART '92”, Viterbo, ed. BetaGamma, Vol. 1, 500-514
2. Uzielli L., Dionisi-Vici P., Ciatti M., Casazza O., Togni M. (2000): A new approach for studying the restrained deformations of painted panels: the Monitoring Cross-Beam. In: A. Guarino (ed.), Proceedings of the 2nd International Congress on “Science and Technology for the safeguard of Cultural Heritage in the Mediterranean Basin” (Paris, 1999), Elsevier: 463-469 (ISBN 2-84299-230-X)
3. Dionisi-Vici P., Fioravanti M., Uzielli L. (2002): “Monitoring moisture-induced deformation of panel paintings: reasons, requirements and a suggested equipment”. 7th International conference “Non-destructive Testing and Microanalysis for the Diagnostics

- and Conservation of the Cultural and Environmental Heritage” 2-6 June 2002, Antwerp, Belgium
4. Dionisi-Vici P., Fioravanti M., Uzielli L. (2002): “La struttura lignea dello Scudo. In: C. Caneva (ed.), *La Medusa del Caravaggio restaurata*”. Retablo Cultura-Arte-Immagine s.r.l., 161-168.
  5. Uzielli L., Dionisi-Vici P., Gril J. (2006): “Caractérisation physico-mécanique du support”. In: Jean-Pierre Mohen, Michel Menu, Bruno Mottin (Coord.) “*Au cœur de la Joconde*”, Gallimard, Musée du Louvre, Paris, 52-55 (ISBN 2-35031-066-3 / 2-07-011833-9).
  6. Lucchetti S., Dionisi-Vici P. (2006): “Wireless apparatus for remote monitoring of e.g. art objects and, in general, of inaccessible objects of any kind”.  
<<http://v3.espacenet.com/textdoc?DB=EPODOC&IDX=GR1005621&F=0>>.



## **ANNEXES**



## ANNEX 1 – FACTS ABOUT COST ACTION IE0601

COST Action IE0601: Wood Science for Conservation of Cultural Heritage (WoodCultHer)

### *Facts about the Action*

(from COST website [http://w3.cost.esf.org/index.php?id=262&action\\_number=ie0601](http://w3.cost.esf.org/index.php?id=262&action_number=ie0601))

Chair of the Action: Professor Luca UZIELLI  
Rapporteur: Professor Zsolt KAJCSOS  
Science Officer: Ms. Caroline WHELAN  
Administrative Officer: Milena STOYANOVA  
Website: [www.woodculther.org](http://www.woodculther.org)

### **Action overview**

#### ***Main objective***

The main objective of the Action is to improve the conservation of our wooden cultural heritage by increasing the interaction and synergy between wood scientists and other professionals applying wood science and technology towards the study, conservation and restoration of wooden artefacts of artistic or historic interest (WCHOs, i.e. Wooden Cultural Heritage Objects).

#### ***Specific objectives may be identified as follows:***

##### *General*

- To put into evidence how the modern scientific knowledge about wood may contribute to Diagnosis and Conservation of wooden Cultural Heritage.
- To favour meeting and interaction, at both scientific and practical level, of researchers in the field of wood, specialists in conservation of wooden artworks, manufacturers of equipment and products which might be successfully used for the diagnosis, restoration and conservation of wooden artworks
- To acquire a deeper insight into several fields and processes concerning wood material (e.g. the ageing processes, their factors (physical, mechanical, biological, chemical, environmental, and their interactions), in order to improve the conservation of wooden artworks.
- To develop criteria for evaluating durability of interventions during very long time (centuries).
- To develop criteria for ensuring “re-treatability” (i.e. that present interventions will not impede future interventions, if and when needed).

##### *Wood deterioration*

- To develop new methods for the evaluation of new techniques and products for the conservation of wooden artworks.
- To acquire further understanding of the process of bacterial wood degradation in order to develop practical conservation methods to preserve historical wooden structures and remains in the soil.
- To further develop micro waves as a conservation method against insect degradation.

##### *Diagnostic methods and equipments*

- To develop and foster the implementation of the use of practical sensors to indicate risk to wooden objects in museums and at historic sites, or during the transportation of artworks.

##### *Interactions between wooden artworks and environment*

- To be able to better evaluate the interactions between individual wooden artworks and environment, also by direct monitoring physical changes and damage processes in objects.

##### *Dendrochronology*

- To stimulate the development of non-destructive high resolution scanners for in situ inspection of wooden objects to identify aging and degradation processes, that also allows tree-ring analyses (dendrochronology) for exact age determination.



- To disseminate results which obtained by applying “dendro-provenancing” techniques, in order to support further historical and technological studies.

#### *Non-destructive inspection of wooden objects*

- To further develop non-destructive methods and equipments, for inspection and evaluation of both movable and non-movable WCHOs.

#### *Numerically modelling of risk of damage*

- To develop and validate mathematical models and computer simulations of short- or long-term phenomena, from the observation of past events and processes, aiming towards prediction of future behaviour.
- To develop methods for predicting by simulation the long-term result of present interventions (e.g. present tendency to provide panel paintings with flexible cross-ties or frames).

#### *Long-term behaviour and “accelerated ageing”*

- To further explore specific subjects such as the properties and behaviour of “old” wood, the influence of ageing on the properties of WCHOs.
- New principles, criteria, observation and evaluation methods need therefore to be developed in order to evaluate expected deterioration of WCHOs in the very long term.
- To acquire knowledge and establish methods for studying deteriorations that take place during very long time periods (decades and centuries), and for evaluating the long-term compatibility of interventions, treatments, products, aiming to improve the conservation of wooden artworks.
- To develop adequate models of the ageing and deterioration processes, deriving from the observation of past events and processes, aiming towards prediction of future behaviour.

#### *Archaeological and archaeo-botanic wood*

- To improve prevention of bacterial decay of wood in foundation piles and archaeological sites.
- To develop methods and standards for evaluating procedures and products for conservation of archaeological and archaeo-botanic wood.

#### *Timber structures*

- To develop specific safety factors for verification of WCHO timber structures.
- To develop appropriate load tests for WCHO timber structures.
- To produce guidelines about criteria for conservation (and reinforcement, if necessary) of WCHO timber structures.
- To produce guidelines and standard documents concerning (for various situations and types of structures) inspection, assessment of load-bearing capacity, use of visual versus instrumental methods, practices and responsibilities.
- To develop criteria for evaluating effectiveness and durability (during very long time, i.e. centuries) of interventions performed on WCHO timber structures.
- To foster development of national or local grading rules for existing “old” timber structural elements; to encourage, make available and compare results of test campaigns aimed to determine reliable strength and stiffness values for such timbers.

#### *Wooden foundations*

- To improve knowledge and techniques appropriate for conserving wooden foundations piles under historical buildings.
- To increase knowledge on the process of bacterial wood degradation under water (e.g. ship wrecks, foundations piles), and to define strategies to control the soil hydrology or water streaming in open water leading to a reduction or even to stop the wood degrading bacterial activity.

#### *Standardization*

- To put in active contact the European scientific communities dealing with conservation of wooden Cultural Heritage, in order to provide a very strong and wide scientific background, and an informed

consensus throughout European countries, for standardization (particularly of CEN/TC 346) in the field of wooden artworks.

- To contribute to European Standardization in the field (inputs to CEN/TC 346 “Conservation of Cultural Property”).
- It should be emphasized here that since in the field of Cultural Heritage each artwork (especially if made of wood) is different (materials, wood species, manufacture, history, environment(s), decay/deterioration, interventions, etc.), each artwork needs/deserves a “personal” care, i.e. individual assessment, evaluation, solutions; therefore the technical standards should specify methods and criteria, not “standard solutions” to problems.

### Action’s details

(updated 2009)

Domain : Materials, Physical and Nanosciences

Memorandum of Understanding: 317/06

CSO Approval date: 20/11/2006

Action started: 18/04/2007

End of Action: 17/04/2011

*Countries having signed the MoU (Total 24):* Austria, Belgium, Czech Republic, Denmark, Finland, Former Yugoslav Republic of Macedonia, France, Germany, Greece, Hungary, Italy, Latvia, Malta, Netherlands, Norway, Poland, Portugal, Romania, Slovenia, Spain, Sweden, Switzerland, Turkey, United Kingdom.

*Countries having expressed Intention to sign the MoU (Total 2):* Estonia, Slovak Republic.

*Non-COST Institutions (Total 3):* RISH (Research Institute for Sustainable Humanosphere), Japan; Scion (New Zealand Forest Research Institute), New Zealand; Agricultural University of Tirana, Faculty of Forestry Sciences, Albania.

### Management Committee of Action IE0601

Chair: Professor Luca UZIELLI

Vice Chair: Dr. Joseph GRIL

COST Participants

Country	MC Member
Austria (MC Member)	Mr. Florian TSCHERNE
Austria (MC Member)	Dr. Michael GRABNER
Belgium (MC Member)	Professor Joris VAN ACKER
Belgium (MC Member)	Mr. Hans BEECKMAN
Belgium (MC Substitute Member)	Professor Andre DE NAEYER
Belgium (MC Substitute Member)	Dr. Kristof HANECA
Belgium (MC Substitute Member)	Ms. Maaïke DE RIDDER
Czech Republic (MC Member)	Dr. Irena KUCEROVA
Denmark (MC Member)	Dr. Poul JENSEN
Denmark (MC Member)	Dr. Lise Stengard HANSEN
Estonia (MC Member)	Mr. Kalle PILT
Finland (MC Member)	Ms. Paula NISKANEN
Finland (MC Substitute Member)	Mr. Jorma LEHTINEN
Former Yugoslav Republic of Macedonia (MC Member)	Ms. Liljana KOVACOVSKA
France (MC Member)	Dr. Joseph GRIL
France (MC Member)	Dr. Emmanuel MAURIN
France (MC Substitute Member)	Dr. Stephane VAIEDELICH
France (MC Substitute Member)	Ms. Catherine LAVIER
Germany (MC Member)	Professor Holger MILITZ
Germany (MC Member)	Dr. Uwe NOLDT

## ANNEX 1

Germany (MC Substitute Member)	Dr. Jochen ADERHOLD
Greece (MC Member)	Dr. Anastasia POURNOU
Greece (MC Member)	Professor Costas FOTAKIS
Hungary (MC Member)	Dr. Zsuzsanna MARTON
Hungary (MC Member)	Dr. Andras MORGOS
Hungary (MC Substitute Member)	Professor Zoltan SZOKEFALVI-NAGY
Italy (MC Member)	Dr. Nicola MACCHIONI
Italy (MC Substitute Member)	Professor Marco FIORAVANTI
Latvia (MC Member)	Ms. Ilze IRBE
Malta (MC Member)	Dr. Claire BALUCI
Malta (MC Member)	Mr. Michael FORMOSA
Netherlands (MC Member)	Dr. Rene KLAASSEN
Netherlands (MC Member)	Dr. Andre J.M. JORISSEN
Netherlands (MC Substitute Member)	Dr. John HAVERMANS
Norway (MC Member)	Ms. Tone Marie OLSTAD
Norway (MC Member)	Dr. Per Otto FLATE
Norway (MC Substitute Member)	Mr. Iver SCHONHOWD
Poland (MC Member)	Dr. Roman KOZLOWSKI
Poland (MC Member)	Mr. Marek STRZELEC
Poland (MC Substitute Member)	Ms. (Pending)
Portugal (MC Member)	Dr. Helena CRUZ
Portugal (MC Member)	Professor Manuel MARTINS COSTA
Portugal (MC Substitute Member)	Dr. Lina NUNES
Portugal (MC Substitute Member)	Dr. Jose SAPORITI MACHADO
Romania (MC Member)	Professor Gheorghe NICULESCU
Romania (MC Member)	Dr. Bogdan CONSTANTINESCU
Slovak Republic (MC Member)	Professor Ladislav REINPRECHT
Slovenia (MC Member)	Professor Franc POHLEVEN
Slovenia (MC Member)	Professor Roko ZARNIC
Spain (MC Member)	Ms. Sales IBIZA-PALACIOS
Spain (MC Member)	Mr. Guillermo INIGUEZ GONZALEZ
Spain (MC Substitute Member)	Mr. (Pending)
Spain (MC Substitute Member)	Mr. (Pending)
Sweden (MC Member)	Professor Thomas NILSSON
Sweden (MC Member)	Dr. Charlotte GJELSTRUP BJORDAL
Switzerland (MC Member)	Dr. Marie WOERLE
Switzerland (MC Member)	Dr. Eberhard LEHMANN
Switzerland (MC Substitute Member)	Dr. Kilian ANHEUSER
Turkey (MC Member)	Dr. Mine TANAC KIRAY
United Kingdom (MC Member)	Dr. David DICKINSON
United Kingdom (MC Member)	Professor George JERONIMIDIS

## Non-COST Participants

Institution	MC Member
Research Institute for Sustainable Humanosphere - (Japan)	Professor Shuichi KAWAI
Scion (New Zealand Forest Research Institute) - (New Zealand)	Dr. Christopher LENTH
Agricultural University of Tirana Faculty of Forestry Sciences - (Albania)	Mr. Hektor THOMA

**The Action's Steering Committee**

The Steering Committee (SC) is formed by the Action's Chairman, Vice-Chairman, Webmaster, and by the Leaders and Vice-Leaders of the three Working Groups; it mainly fulfils the following roles:

- a) to support the Chairman in making urgent decisions that will later be submitted for MC ratification (e.g. in approving Short term Scientific Missions, or in declaring if a proposed research project fits into the framework of our Action, when national Authorities, in order to allocate research funds to national Institutions, require an expression of formal support to such projects from Chairs of relevant COST Actions);

- b) to discuss and prepare policies and future activities to be later discussed by the MC, and
- c) to organize and steer future meetings and activities, according to the guidelines approved by the MC.

The Steering Committee of COST Action IE0601

Luca Uzielli	Chairman	Italy	luca.uzielli@unifi.it
Joseph Gril	Vice Chairman	France	jgril@lmgc.univ-montp2.fr
Thomas Nilsson	WG1 – Leader	Sweden	thomas.nilsson@trv.slu.se
George Jeronimidis	WG1 – Vice Leader	United Kingdom	g.jeronimidis@reading.ac.uk
Roman Kozlowski	WG2 – Leader	Poland	nckozlow@cyf-kr.edu.pl
Eberhart Lehmann	WG2 – Vice Leader	Switzerland	eberhard.lehmann@psi.ch
Helena Cruz	WG3 – Leader	Portugal	helenacruz@lnec.pt
Tone Marie Olstad	WG3 – Vice Leader	Norway	tone.olstad@niku.no
Marco Fioravanti	Webmaster	Italy	marco.fioravanti@unifi.it

### The Action's Working Groups

#### ***WG1 “Wood Properties”***

Mechanisms and characterisation of wood ageing, degradation and transformation processes, focussing on changes of properties and behaviour of wood and wooden artworks. Properties would include ultra-structural, physical and mechanical, chemical, rheological, biological, etc., including ageing processes of archaeological and water-logged wood.

#### ***WG2 “Assessment & Diagnosis”***

Evaluation of destructive, non-destructive and non-invasive methods and equipments for in-situ and ex-situ assessments and diagnosis and study of Wooden Cultural Heritage Objects (WCHO's). Analysis of agents and causes of deterioration.

#### ***WG3 “Conservation & Restoration”***

Evaluation of existing and new procedures, methods, techniques and products for interventions on wooden WCHO's (“acceptable, respectful and compatible”).

*Note:* WGs are useful for several organizational aspects, however the Action's activities – due to their interdisciplinary nature – are mainly carried out through Plenary or Focused (thematic) meetings.

## **Annex 2 – Final Programme**

3rd MC & Workshop Meeting - Florence (Italy), 8-10 November 2007

Venue: Hotel Mediterraneo - Lungarno del Tempio 44 - 50121 Firenze - Italia

### **Thursday 8 November 2007**

- (12:00-4.00) Registration of Participants - Lunch
- 14:00-14:15 Opening of the Meeting
- 14:15-17:30 **Session managed by WG1**
- 14:15-16:00 Topic 1 “Historic wood – structure and properties”
- 16:00-16:30 Coffee Break
- 16:30-17.30 Topic 2 “Wood material – ageing and non-biological degradation”
- (17:30-18:30) **Management Committee meeting (part 1)**
- 17:30-20:30 Free time (no dinner organized)
- 20:30-23.00 **Scientific visit in San Marco Museum** - Piazza San Marco  
(return to Hotel by private bus)

### **Friday 9 November 2007**

- 08:30-12:30 **Session managed by WG2**
- 08:30-10:00 Topic 3 “Diagnosing the surface of painted wood”
- 10:00 - 10:30 Coffee break
- 10:30-12:30 Topic 4 “Diagnosing the efficiency of object treatments”
- 12.30-14:00 Lunch (in hotel), visit to posters
- 14:00-17:30 **Session managed by WG3**
- 14:00-15:40 Topic 5 “State of the art of contributions from Wood Science to conservation issues”
- 15:40-16:30 Coffee-break + short presentations in poster area
- 16:30-17:30 Topic 6 “Expressing needs in the field of conservation, of objects and/or monuments, in matter of Wood Science”

17:30-20:00	Free time
(17:30-19:00)	Steering Committee Meeting
20:00-23:00	Dinner in “Circolo dell'Unione” - Via Tornabuoni 7 (Jacket and tie needed - Return to Hotel by private bus)

**Saturday 10 November 2007**

08:30-10:00	<b>Parallel meeting sessions of WGs</b>
10:00 - 10:30	Coffee-break
10:30 - 10:45	<b>Presentation of COST Action D42</b>
10:45-11:30	<b>Plenary session, general discussion, conclusions from the Meeting</b>
(11:30-12:30)	<b>Management Committee meeting (part 2)</b>
12:30-14:00	Lunch (in hotel), visit to posters
14:00-17:00	<b>Scientific visit to OPD restoration laboratory</b> (Viale Filippo Strozzi 1)
17:00	<b>End of the Meeting</b>

**List of Presentations (Orals and Posters)**

Note. Unfortunately some Authors, although having presented their paper (Oral or Poster), were not able to submit it for publication. In some cases, the screen presentations they offered can be found on the Action's website <<http://www.woodculther.org>>

**Session managed by WG1** (Thursday, 8 November - 14:15-17:30)

	Topic 1 “Historic wood – structure and properties”		
14:15-14:50	<u>Thomas Nilsson</u> and Roger Rowell	Historic wood – structure and properties (Keynote lecture)	USA - Sweden
14:50-15:20	<u>Eiichi Obataya</u>	Effects of ageing and heating on the mechanical properties of wood	Japan
15:20-16:00	<u>Bjarne Holmbom</u>	Chemistry of wood ageing and degradation. A review of non-biological processes	Finland
16:00-16:30	Coffee Break		

## ANNEX 2

	Topic 2 “Wood material – ageing and non-biological degradation”		
16:30-17:00	Diego Dreossi, Stefano Favretto, Marco Fioravanti, Lucia Mancini, Luigi Rigon, Nicola Sodini, Giuliana Tromba, <u>Franco Zanini</u>	Synchrotron radiation microtomography: a non-invasive tool for the characterization of archaeological wood	Italy
17:00-17:30	Tommy Iversen, EvaLisa Lindfors and <u>Mikael Lindström</u>	Polysaccharide degradation in Vasa oak wood	Sweden

## Posters relating to WG1 subjects (no oral presentation)

	<u>Gunnar Almkvist</u>	Micro-distribution of inorganic compounds in relation to wood degradation processes in the Vasa	Sweden
	Nicola Luchi, <u>Paolo Capretti</u> , Aniello Scala	Detection and early identification of decay fungi: from standing trees to wood substrates	Italy
	<u>Maria Petrou</u> , Rob C. Janaway, Gill B. Thompson, Andrew S. Wilson	Degradation mechanisms of waterlogged archaeological pine timber from northern Greece	Greece
	<u>János Veres</u>	I was walking in an 8 million years old forest...	Hungary
	<u>Irena Kučerová</u> , Martina Ohlídalová, Miroslava Novotná	Examination of damaged wood by ammonium phosphate and sulphate-based fire retardants – The results of the Prague Castle roof timber examination	Czech Republic
	<u>Magdalena Zborowska</u> , Leszek Babiński, Bogusława Waliszewska, Włodzimierz Prądkowski	State of preservation of historic wood from fortified settlement of the Lusatian culture in Biskupin (Poland)	Poland

**Scientific visit, San Marco Museum** (Thursday, 8 November - 20:30-23:00)

	<u>Magnolia Scudieri</u>	Monumental buildings and conservation problems: a complex approach	Italy
	<u>Paolo Dionisi Vici</u> , Ilaria Bucciardini, Marco Fioravanti, Luca Uzielli	Monitoring climate and deformation of panel paintings in San Marco (Florence) and other Museums	Italy

**Session managed by WG2** (Friday, 9 November - 08:30-12:30)

Topic 3 “Diagnosing the surface of painted wood”			
08:30 - 09:00	<u>Dario Ambrosini</u>	Optical techniques in wooden paintings diagnostics	Italy
09:00 - 09:30	<u>Hiltrud Brocke, Jochen Aderhold</u>	Infrared imaging techniques for the study of paintings and other artwork	Germany
09:30 - 10:00	<u>Jean Angelo Beraldin, Francois Blais, Marc Rioux</u>	Diagnosing wood artworks surface through state-of-the-art high-resolution optical 3D imaging techniques	Canada
10:00 - 10:30	Coffee break		
Topic 4 “Diagnosing the efficiency of object treatments”			
10:30 - 11:00	<u>Vivi Tornari</u>	Evaluation of restoration processes with holographic interferometry: exploitation of visual fringe pattern data to assess restoration interventions	Greece
11:00 - 11:30	<u>Uwe Noldt</u>	Monitoring wood-destroying insects in wooden cultural heritage	Germany
11:30 - 12:00	<u>Irena Kučerová, Burghard Schillinger, Elbio Calzada, Eberhard Lehmann</u>	Monitoring the transport of acrylate consolidants through the wood by neutron radiography	Czech Republic
12:00 - 12:30	<u>Khôi Tran</u>	Various physical and analytical methods to control the impregnation efficiency of archaeological artefacts by different consolidating resins	France

**Posters relating to WG2 subjects** (no oral presentation)

<u>Ottaviano Allegretti, Francesca Raffaelli</u>	External resistance to water vapour transfer of varnishes on wood	Italy
<u>Manuel F. M. Costa</u>	Microtopographic and rugometric inspection of wood artifacts	Portugal
<u>Łukasz Lasyk, Michał Łukomski, Łukasz Bratasz</u>	Mapping climate-induced damage of paint layers on wood by Electronic Speckle Pattern Interferometer (ESPI)	Poland



## ANNEX 2

<u>Łukasz Lasyk, Michał Łukomski, Łukasz Bratasz</u>	3D laser scanning of 'Christ blessing the children' by Lucas Cranach the Elder	Poland
<u>Anna P. Moutsatsou, E. Kouloumpi, J. Olafsdottir, M. Trompeta, C. Tsaroucha, M. Doulgeridis, R. M. Groves, V. Tornari</u>	Protocols for the construction and characterization of model panel paintings for the evaluation of structural diagnosis techniques	Greece
<u>Krzysztof Chmielewski</u>	Investigation of paint layers of the fifteenth century Saint Barbara polyptych from the collection of the National Museum in Warsaw	Poland
<u>Ludmila Otilia Cinteza, Gheorghe Niculescu</u>	Diagnosing efficiency of cleaning old wooden objects using new o/w microemulsions with environmental friendly components	Romania

**Session managed by WG3** (Friday, 9 November - 14:00-17:30)

	Topic 5 "State of the art of contributions from Wood Science to conservation issues"	
14:00-14:20	<u>Charlotte G Björdal, Thomas Nilsson</u>	Understanding microbial degradation of waterlogged archaeological wood Sweden
14:20-14:40	M. Grabner, <u>F. Tscherne</u>	How to evaluate a historical roof construction? Austria
14:40-15:00	<u>Roman Kozłowski</u>	Target microclimates for preservation of wooden objects: an attempt at standardisation Poland
15:00-15:20	<u>Nicola Macchioni</u>	Standardisation activity on wooden cultural heritage in Italy Italy
15:20-16:30	Coffee-break + short presentations in poster area	
	Topic 6 "Expressing needs in the field of conservation, of objects and/or monuments, in matter of Wood Science"	
16:30-16:50	<u>Marco Ciatti</u>	Experiences and problems in panel paintings conservation Italy
16:50-17:10	<u>Elzbieta Jezewska</u>	Needs for conservation of paintings on engineered wood supports Poland

17:10-17:30	<u>Rene Klaassen</u>	Use of wood technology for protection of cultural heritage (sampling on wooden foundations; predicting the remaining strength and their remaining life span)	Netherlands
-------------	----------------------	--	-------------

### Posters relating to WG3 subjects

(15:20-16:30)	WG3 short presentations in front of poster (timing and mode of presentation might be modified)		
	<u>Anita Drexel</u>	Timber Structures in Gardens – A temporary Object? Needs and Strategies for Preservation	Austria
	<u>Emmanuel Maurin, Philippe Galimard</u>	Local reinforcement of timber structures using “resin-based” methods. Research needs: effect of temperature on reinforcement behaviour, problem of diagnostic of reinforcement efficiency	France
	<u>Jolanta Ratuszna</u>	Microclimate in the Malbork Castle, Poland: selection of heating strategy to preserve wooden objects	Poland
	<u>Julien Colmars, R. Rémond, B. Marcon, J. Gril, P. Perré, P. Dionisi Vici, D. Jullien, E. Maurin</u>	In-situ monitoring and hygrothermal modelling of a wood panel painting: the case of the Saint Didier church in Avignon, Couronnement d'épines	France
	<u>Daniel-Constantin Negut, C.C. Ponta, R. M. Georgescu, O H Barbu</u>	Colour tests for irradiated painted wood panels	Romania
	<u>Maurice van Gennip, Jeroen Baars</u>	Actual status of old under water wooden foundations	Netherlands
	<u>Huub Baija</u>	Consolidating wooden art objects	Netherlands
	WG3 posters (no presentation)		
	<u>Mine Tanac Zeren</u>	Comparison of the deterioration and conservation issues of wooden door types of traditional turkish houses	Turkey
	<u>Özgül Y. Karaman</u>	Structural use of wood in traditional Turkish houses	Turkey
	<u>Lina Nunes, Dulce</u>	Diagnosis of timber	Portugal

ANNEX 2

Henriques, Helena Cruz	structures. A case study	
<u>Hektor Thoma</u> , Dritan Ajdinaj, Etleva Bushati, Holta Çota, Entela Lato, Doclea Quku	Technological analysis of some Albanian icons, carried out at Department of wood technology, UBT, Tirana	Albania
<u>Sandie Lecomte</u> , S. Le Moyné, F. Ollivier, J. Frelat, S. Vaiedelich	Mechanical modelization and holography measurement: application to the restoration and conservation of the Couchet Harpsichord	France
<u>Katarzyna Krolikowska-</u> <u>Pataraja</u>	Conservation of archaeological wood with sucrose	Poland
<u>Jan Marczak</u> , Andrzej Koss, Maria Lubryczyńska, Joanna Czernichowska, Izabela Uchman- Laskowska, Krzysztof Chmielewski, Magdalena Mazur, Agnieszka Markowska, Marek Strzelec	Wooden art works – Laser cleaning case studies	Poland

**ANNEX 3 – IE0601 3RD MC & CONFERENCE – FLORENCE (ITALY), 8-10  
NOVEMBER 2007. LIST AND ADDRESSES OF PARTICIPANTS**

(mostly as provided at the Conference, with a few later integrations and corrections)

Dr. Jochen ADERHOLD  
Department Head Process Measurement Technology  
Fraunhofer Institute for Wood Research  
Wilhelm-Klauditz-Institut, WKI  
Bienroder Weg 54E, D-38108 Braunschweig  
Tel: +49 531 2155-424, Fax: +49 531 351587  
jochen.aderhold@wki.fraunhofer.de

Ottaviano ALLEGRETTI  
Wood Drying Laboratory (LABESS)  
CNR IVALSA - Timber and Trees Institute  
Via Biasi 75  
38010, San Michele all'Adige (TN)  
ITALY  
Tel +39 0461 660 203- 241  
Fax +39 0461 650045  
allegretti@ivalsa.cnr.it  
www.ivalsa.cnr.it

Gunnar ALMKVIST  
Department of Chemistry  
Swedish University of Agricultural Sciences  
P. O. Box 7015  
SE-750 07 Uppsala  
phone: +46 (0)18 67 15 49  
Gunnar.Almkvist@kemi.slu.se

Dario AMBROSINI  
Associate Professor  
DIMEG  
Dipartimento di Ingegneria Meccanica, Energetica e Gestionale  
Università dell'Aquila  
Via G. Gronchi 18, Zona Industriale di Pile,  
67100 L'Aquila,  
Italy  
fax. : ++39 0862 434303  
ph. : ++39 0862 434336  
dario.ambrosini@ing.univaq.it  
http://laser.ing.univaq.it

Kilian ANHEUSER  
Curator in charge of Preventive Conservation  
Musée d'Ethnographie  
Boulevard Carl-Vogt 65  
P.O. Box 191  
CH-1211 Genève 8, Switzerland  
kilian.anheuser@ville-ge.ch

Jeroen BAARS  
 Baars-CIPRO  
 Hoofdweg 16A  
 1175 LA LIJNDEN  
 t: +31-(0)23-555-1547  
 f: +31-(0)23-555-1798  
 j.baars@baars-cipro.nl  
<http://www.baars-cipro.nl>

Hubert BAIJA  
 Senior Conservator  
 Rijksmuseum Amsterdam  
 Postbus/PO Box 74888, 1070 DN Amsterdam  
 The Netherlands  
 T +31 (0) 20 6747290  
 H.Baija@rijksmuseum.nl  
<http://www.rijksmuseum.nl/organisatie/sectorcollecties/hubertbaija?lang=en>

J-Angelo BERALDIN  
 Principal Research Officer  
 Lead 3D imaging metrology Research Program  
 Visual Information Technology  
 Institute for Information Technology  
 National Research Council Canada  
 1200, Montreal Rd, Ottawa, Ontario, Canada, K1A-0R6  
 Tel: (613) 990-6871 Facsimile: (613) 952 -0215  
 mailto: angelo.beraldin@nrc-cnrc.gc.ca  
[http://www.nrc-cnrc.gc.ca/eng/people/beraldin\\_jean-angelo\\_4320.html](http://www.nrc-cnrc.gc.ca/eng/people/beraldin_jean-angelo_4320.html)

Charlotte Gjelstrup BJÖRDAL  
 Docent / Associate professor  
 SP Sveriges Tekniska Forskningsinstitut  
 SP Technical Research Institute of Sweden  
 SP Träteknik/ Wood technology  
 Box 5609, SE-114 86 Stockholm, Sweden  
 Tel: +46 10 516 50 00, (direkt) +46 10 516 6225 Telefax: +46 (0)8 411 83 35  
 charlotte.bjordal@sp.se  
[www.sp.se](http://www.sp.se)

Susan BRAOVAC  
 Objects Conservator, Department of Conservation  
 Museum of Cultural History  
 University of Oslo  
 P.O. Box 6762 St.Olavs plass  
 NO-0130 Oslo, Norway  
 Tlf./faks: +47 22 85 93 40 / +47 22 85 95 24  
 Tel.reception: +47 22 85 19 00  
 susan.braovac@khm.uio.no  
[www.khm.uio.no](http://www.khm.uio.no)

Łukasz BRATASZ  
 Institute of Catalysis and Surface Chemistry,  
 Polish Academy of Sciences  
 ul. Niezapominajek 8,  
 30-239 Kraków, Poland  
 ncbratas@cyf-kr.edu.pl

Dr.-Ing. Hiltrud BROCKE  
Fachbereich Prozessmesstechnik  
Fraunhofer-Institut für Holzforschung  
Wilhelm-Klauditz-Institut, WKI  
Bienroder Weg 54E, D-38108 Braunschweig  
Tel: +49 531 2155-342, Fax: +49 531 2155-200  
hiltrud.brocke@wki.fraunhofer.de

Prof. Paolo CAPRETTI  
Dipartimento di Biotecnologie Agrarie  
Piazzale delle Cascine, 27 - 50144 Firenze  
Tel. 055 3288275  
Fax 055 3288273  
paolo.capretti@unifi.it

Krzysztof CHMIELEWSKI  
Academy of Fine Arts in Warsaw, Faculty of  
Conservation and Restoration of Works of Art,  
Inter-Academy Institute for Conservation and  
Restoration of Works of Art  
Academy of Fine Arts, Wybrzeze  
Kosciuszkowskie 37, 00-379 Warsaw, Poland  
Tel +48 – 22 6251251  
Fax +48 – 22 6229649  
chmiel@asp.waw.pl

Dott. Marco CIATTI  
OPD – Opificio delle Pietre Dure  
Laboratori di Restauro  
Viale Filippo Strozzi 1  
50129 Firenze  
Fax 055 4625448  
mciatti@gmail.com

Dr. Otilia CINTEZA  
University of Bucharest, Physical Chemistry Department,  
4-12 Elisabeta Blvd, 30118  
Bucharest, Romania  
ocinteza@gmail.com

Julien COLMARS  
Laboratoire de Mécanique et Génie Civil  
UMR 5508 CNRS – Université Montpellier 2  
LMGC – UM2, Place E. Bataillon CC 048  
F-34095 Montpellier cdx 5, France  
julien.colmars@imelavi.fr  
colmars@lmgc.univ-montp2.fr

Prof. Manuel Filipe COSTA  
Universidade do Minho - Departamento de Física  
4710-057 Braga (Portugal)  
Tel: +351 253604334  
Fax: +351 253678981  
mfcosta@fisica.uminho.pt

Helena Maria Pires CRUZ  
LNEC – Laboratório Nacional de Engenharia Civil  
Av do Brasil, 101  
1700-066 Lisboa. Portugal  
Tel +351 – 21 8443295  
Fax +351 – 21 8443025  
helenacruz@lnec.pt

André DE NAEYER, prof.ir.arch.  
Artesis University College - Dep. Architectural and Urban Conservation  
Mutsaardstraat, 31,  
B-2000 ANTWERPEN Belgium  
Tel. +32.(0)32 056 170 Mob.+32(0)478 269 176  
denaeyer.andre@gmail.com

Roberta DI BIASE  
DIMEG, University of L'Aquila  
Via G. Gronchi 18, Zona Industriale di Pile, 67100 L'Aquila, Italy  
<http://laser.ing.univaq.it>

Dr Dave J DICKINSON  
Reader in wood science  
Dept. of Biological Sciences  
Sir Alexander Flemming Building  
South Kensington Campus  
Imperial College London  
London SW7 2AZ UK  
Tel +44(0) 20 7594 5391  
Mob. +44(0) 7867516481  
Fax. +44(0) 20 7594 5390  
davedickinson44@googlemail.com  
[www.imperial.ac.uk/biologicalsciences](http://www.imperial.ac.uk/biologicalsciences)

Dr. Paolo DIONISI VICI  
University of Florence  
DEISTAF - Department of Agricultural and Forest Economics, Engineering, Sciences  
and Technologies Division of Forest Environmental Sciences and Technologies  
13 Via San Bonaventura  
50145 Firenze  
Italy  
pdv64@inwind.it  
Paolo.DionisiVici@metmuseum.org

Ass.Prof. Dipl.Ing.Dr. Anita DREXEL  
Universität für Bodenkultur  
Institut für Ingenieurbiologie und Landschaftsbau  
Peter Jordan-Straße 82  
A-1190 Wien  
Tel.: +43 1 47654-7307  
Fax: +43 1 47654-7349  
anita.drexel@boku.ac.at  
[www.boku.ac.at/iblb](http://www.boku.ac.at/iblb)

Erika FALZON  
Paintings Conservator  
Conservation Division  
Heritage Malta  
Bighi, Kalkara CSP12, Malta  
Tel: (+356) 21 807675/6 Ext 248  
Fax: (+356) 21 674457  
Mobile: (+356) 9944 5055  
erika.falzon@gov.mt  
www.heritagemalta.org

Prof. Marco FIORAVANTI  
University of Florence  
DEISTAF - Department of Agricultural and Forest Economics, Engineering, Sciences  
and Technologies  
Division of Forest Environmental Sciences and Technologies

Michael FORMOSA  
Heritage Malta  
Old University Buildings  
Merchants Street  
Valletta VLT 03  
Malta  
Tel: +356 2295 4000, 2295 4300  
Fax: +356 2122 2900  
michael.formosa@gov.mt

Giacomo GOLI PhD  
University of Florence  
DEISTAF - Department of Agricultural and Forest Economics, Engineering, Sciences  
and Technologies  
Division of Forest Environmental Sciences and Technologies  
13 Via San Bonaventura - 50145 FIRENZE (Italia)  
Tel. +39 055 3288 675 Fax +39 055 319 179 Mobile +39 3290656674  
giacomo.goli@unifi.it

Dr. Michael GRABNER  
University of Natural Resources and Applied Life Sciences Vienna  
Peter Jordan Strasse 82  
1190 Vienna  
Tel. ++43-1-47654-4268  
Fax. ++43-1-47654-4295  
michael.grabner@boku.ac.at  
www.boku.ac.at/holzforschung

Joseph GRIL  
Laboratoire de Mécanique et Génie Civil  
UMR 5508 CNRS – Université Montpellier 2  
LMGC – UM2, Place E. Bataillon CC 048  
F-34095 Montpellier cdx 5  
Tel +33 – 4 6714 3433  
Fax +33 – 4 6714 4792  
Mob +33 – 6 7493 6144  
jgril@lmgc.univ-montp2.fr



Bjarne HOLMBOM  
Professor  
Åbo Akademi University  
Process Chemistry Centre of Excellence  
Laboratory of Wood and Paper Chemistry  
Porthansgatan 3, FI-20500 Turku/Åbo, Finland  
Phone: +358 22 154 229, Mobile: +358 40 541 3121  
Fax: + 358 22 154 868  
bjarne.holmbom@abo.fi

Ilze IRBE  
Laboratory of Wood Biodegradation and Protection  
Latvian State Institute of Wood Chemistry  
Dzerbenes St. 27, Riga LV-1006, LATVIA  
Tel: +371 67545137  
Fax: +371 67550635  
ilzeirbe@edi.lv

George JERONIMIDIS  
Centre for Biomimetics  
Composite Materials Engineering  
School of Construction Management and Engineering  
The University of Reading  
Whiteknights, Reading RG6 2AY, UK  
Tel: +44-118-378 8582  
Fax: +44-118-931 33 27  
g.jeronimidis@reading.ac.uk

Elzbieta JEZEWSKA  
Academy of Fine Arts in Warsaw, Faculty of  
Conservation and Restoration of Works of Art,  
Inter-Academy Institute for Conservation and  
Restoration of Works of Art  
Academy of Fine Arts, Wybrzeze  
Kosciuszkowskie 37, 00-379 Warsaw, Poland  
Tel +48 – 22 6251251  
Fax +48 – 22 6229649  
ejez@interia.pl

André JORISSEN  
University of Technology, Eindhoven  
P.O. Box 513  
5600 MB Eindhoven.  
Tel +31 – 40 2472990  
Fax +31 – 40 2450328  
a.j.m.jorissen@bwk.tue.nl

Özgül Yilmaz KARAMAN, Architect M.Sc.  
Tinaztepe Campus  
Dokuz Eylul University  
Faculty of Architecture, KURUCESME-BUCA  
35160 IZMIR - Turkey  
ozgul.yilmaz@deu.edu.tr

Dr. René K. W.M. KLAASSEN  
SHR Foundation of Timber Research  
Postbox 497 postal code NL 6700 AL  
Wageningen, The Netherlands  
phone: +31 317 467366 fax +31 317 467399  
r.klaassen@shr.nl

Roman KOZLOWSKI  
Cultural Heritage Research  
Institute of Catalysis and Surface Chemistry,  
Polish Academy of Sciences  
ul. Niezapominajek 8  
30-239 Kraków, Poland  
tel: +48-12-6395119  
fax: +48-12-4251923  
nckozlow@cyf-kr.edu.pl

Irena KUCEROVA  
Institute of Chemical Technology, Prague  
Department of Chemical Technology of Monument Conservation  
Technická 5  
166 28, Prague 6 - Dejvice  
Czech Republic  
irena.kucerova@vscht.cz  
<http://www.vscht.cz/>  
<http://www.vscht.cz/rud/>

Dr Hartmut KUTZKE  
Associate Professor  
Museum of Cultural History, University of Oslo  
Postboks 6762 St. Olavs plass  
N-0130 Oslo, Norway  
Phone: +47 22 85 94 77  
hartmut.kutzke@khm.uio.no

Lukasz LASYK  
Institute of Catalysis and Surface Chemistry  
Polish Academy of Sciences  
ul. Niezapominajek 8  
30-239 Krakow, Poland  
ukk1998@gmail.com

Sandie LE CONTE  
Cité de la Musique Paris  
Laboratoire de recherche et de restauration  
221 Avenue Jean Jaurès  
75019 Paris France  
Tel +33 – 1 4484 4682  
Fax +33 – 1 4484 4641  
sleconte@cite-musique.fr

Eberhard H. LEHMANN  
Paul Scherrer Institut  
CH-5232 Villigen PSI Switzerland  
Tel +41 – 56 310 2963  
Fax +41 – 56 310 3131  
eberhard.lehmann@psi.ch

Mikael LINDSTRÖM  
Innventia AB,  
CP 5604, SE-11486 Stockholm, Sweden  
Tel +46 - 8676 7433  
Fax +46 -84115518  
Mob +46 - 768767433  
Mikael.lindstrom@innventia.com

Nicola LUCHI  
Dipartimento di Biotecnologie Agrarie  
Piazzale delle Cascine, 27 - 50144 Firenze  
Tel. 055 3288275  
Fax 055 3288273  
nicola.luchi@unifi.it

Michał ŁUKOMSKI  
Institute of Catalysis and Surface Chemistry,  
Polish Academy of Sciences  
ul. Niezapominajek 8,  
30-239 Kraków, Poland  
Tel +48 – 126395190  
Fax +48 – 12 4251923  
Mob +48 – 606384251  
nclukoms@cyf-kr.edu.pl

Nicola MACCHIONI  
IVALSA - CNR  
Via Madonna del Piano, 10  
I - 50019 Sesto Fiorentino  
Tel. +39 055 5225502  
Fax +39 055 5225507  
Mob. +39 3406885371  
macchioni@ivalsa.cnr.it  
www.ivalsa.cnr.it

Bertrand MARCON  
Laboratoire de Mécanique et Génie Civil  
UMR 5508 CNRS – Université Montpellier 2  
LMGC – UM2, Place E. Bataillon, CC 048  
F-34095 Montpellier cdx 5  
Tel +33 – 4 6714 9642  
marcon@lmgc.univ-montp2.fr

Prof Jan MARCZAK  
Military University of Technology, Institute of  
Optoelectronics  
2 Gen. S. Kaliskiego Str.,  
00-908 Warsaw, Poland  
Tel +48 – 22 6839345  
Fax +48 – 22 6668950  
jmarczak@wat.edu.pl

Dr. Zsuzsanna MÁRTON  
research fellow  
University of Pécs  
Institute of Physics  
7624 Pécs, Ifjúság útja 6.  
Tel: +36 72 503 600/4412  
Fax: +36 72 501 571  
marton@fizika.ttk.pte.hu

Emmanuel MAURIN  
Laboratory of Research on Historical Monuments  
29 rue de Paris  
77420 Champs Marne  
Tel +33 – 1 6037 7792  
Fax +33 – 1 6037 7799  
Mob +33 – 6 3742 5224  
emmanuel.maurin@culture.gouv.fr

Paola MAZZANTI PhD  
University of Florence  
DEISTAF - Department of Agricultural and Forest Economics, Engineering, Sciences  
and Technologies  
Division of Forest Environmental Sciences and Technologies  
13 Via San Bonaventura - 50145 FIRENZE (Italia)  
Tel. +39 055 3288 675 Fax +39 055 319 179 Mobile +39 340 2919817  
paola.mazzanti@unifi.it

(Prof Dr) Holger MILITZ  
Institut für Holzbiologie und Holztechnologie  
(Institute for Wood Biology and Wood  
Technology), Georg-August-Universität  
Göttingen  
Büsgenweg, 4, D-37077 Göttingen  
Tel +49 – 551 393541  
Mob +49 – 151 15332560  
hmilitz@gwdg.de

Anna MOUTSATSOU  
National Gallery, Alexandros Soutzos Museum  
1, Michalakopoulou str., 11601 Athens, Greece  
Phone. +30 – 2107235937, ext. 150  
Tel +30 – 2107 250087,  
Fax +30 – 2107 250087,  
Mob +30 – 6932 102994  
annamoutsatsou@nationalgallery.gr

Prof. Parviz NAVI  
Laboratory for Building Materials  
Institute of Materials Science  
Swiss Federal Institute of Technology - Lausanne  
Address: EPFL, MX-G Ecublens, CH - 1015 Lausanne, Switzerland  
Phone: ++41 (21) 693 2838  
Fax: ++41 (21) 693 5800  
parviz.navi@epfl.ch

Daniel Constantin NEGUT  
IRASM Center  
HORIA HULUBEI National Institute of R&D for Physics and Nuclear Engineering  
PO BOX MG-6  
R-077125  
Bucharest-Magurele, ROMANIA  
Tel.: +40 21 404 23 20  
Fax: +40 21 457 53 31  
Mobil: +40 723 882 816  
dnegut@nipne.ro  
<http://www.nipne.ro>  
<http://www.irasr.ro>

Professor Gheorghe NICULESCU  
National Research Laboratory for Conservation and Restoration of National Cultural  
Heritage  
Calea Victoriei nr. 12, sector 3  
30026 Bucuresti  
Romania  
Tel. +40 21 3127225  
Fax. +40 21 3127225  
niculescu.geo@gmail.com

Karl Thomas NILSSON  
Swedish University of Agricultural Sciences  
c/o SP Trätekt, Box 5609,  
SE-114 86 Stockholm, Sweden  
Tel +46 – 105166208  
Fax +46 – 84118355  
Mob +46 – 706226503  
Thomas.Nilsson@trv.slu.se

Paula NISKANEN  
MA, Senior Lecturer  
Helsinki Metropolia University of Applied Sciences  
Degree Programme in Conservation  
Faculty of Culture and Creative Industries  
PO Box 4072, FI-00079 Metropolia, Finland  
Tel. +358 40 183 7466  
paula.niskanen@metropolia.fi

Dr. rer. nat. Uwe NOLDT  
Johann Heinrich von Thünen-Institut (vTI) / Bundesforschungsinstitut für Ländliche  
Räume, Wald und Fischerei  
Institut für Holztechnologie und Holzbiologie (HTB)  
Leuschnerstrasse 91  
D-21031 Hamburg  
+49-40 - 739 62 433 (tel)  
+49-40 - 739 62 499 (fax)  
uwe.noldt@vti.bund.de  
www.vti.bund.de

Lina NUNES  
LNEC – Timber Structures Div.  
Av.do Brasil, 101  
1700-066 Lisboa –Portugal  
linanunes@lnec.pt

Eiichi OBATAYA  
Graduate School of Life and Environmental Sciences  
University of Tsukuba  
Tsukuba 305-8572, Ibaraki  
Japan  
Phone: +81-29-853-4649  
Fax: +81-29-853-4894  
obataya@sakura.cc.tsukuba.ac.jp

Tone Marie OLSTAD  
Norwegian Institute for Cultural Heritage Research  
Postboks 736, Sentrum, N-0105 OSLO, Norway  
Tel +47 – 2335 5000  
Fax +47 – 2335 5001  
tone.olstad@niku.no

Katarzyna KRÓLIKOWSKA-PATARAJA  
Academy of Fine Arts in Warsaw,  
Faculty of Conservation and Restoration of Works of Art,  
Inter-Academy Institute for Conservation and  
Restoration of Works of Art  
Academy of Fine Arts, Wybrzeze  
Kosciuszkowskie 37, 00-379 Warsaw, Poland  
kasiapataraja@op.pl

Maria PETROU  
Dragatsaniou, 24  
15343, Ag. Paraskevi  
Athens  
Greece  
petroumar@yahoo.gr

Prof. Dr. Franc POHLEVEN  
University of Ljubljana  
Biotechnical Faculty  
Ljubljana  
Slovenia  
t: +38614231161  
f: +38614235035  
franc.pohleven@bf.uni-lj.si

Corneliu - Catalin PONTA  
“Horia Hulubei” (IFIN-HH) National Institute of Nuclear Physics and Engineering  
IRASM  
POB MG-6, Bucharest, Romania  
Phone: 0040 21 404 2320  
Fax: 0040 21 457 53 31  
cponta@ifin.nipne.ro

Anastasia POURNOU  
Technological Educational Institute of Athens,  
Department of Conservation of Antiquities and  
Works of Art.  
Ag. Spyridonos, Aigaleo  
12210 Athens, Greece  
Tel +30 – 210 5385469, 476  
Fax +30 – 210 5385406  
pournoua@teiath.gr

Jolanta RATUSZNA  
museum collections conservator  
Malbork Castle Museum, Poland  
jollunia@poczta.onet.pl

Iver SCHONHOWD  
Seksjonssjef  
FoU-seksjonen  
Riksantikvaren, Directorate for Cultural Heritage  
Postboks 8196, 0034 Oslo  
+4798202817  
isc@ra.no

Dott.ssa Magnolia SCUDIERI  
Director Museo di San Marco  
Soprintendenza PSAE – Polo Museale Fiorentino  
Piazza San Marco 3, 50121 Firenze  
scudieri@polomuseale.firenze.it

Dr Marek STRZELEC  
Institute of Optoelectronics  
Military University of Technology  
Laboratory of Laser Applications  
2 Gen. S. Kaliskiego Str., 00-908 Warsaw 49, Poland  
Phone: +4822 6837813; Fax: +4822 6668950  
mstrzelec@wat.edu.pl

Dr. MİNE TANAC ZEREN  
Tinaztepe Campus  
Dokuz Eylul University  
Faculty of Architecture, KURUCESME-BUCA  
35160 IZMIR - Turkey  
Tel. 0090 232 4128410  
Fax. 0090 232 4532986  
mine.tanac@deu.edu.tr

David THICKETT  
Senior Conservation Scientist  
Collections Conservation Team  
English Heritage 3 Bunhill Row, London EC1Y 8YZ  
postal address English Heritage 1 Waterhouse Square, 138 Holborn, London EC1N  
2ST  
tel +44 (0) 207973 3322  
fax +44 (0) 207973 3209  
David.Thickett@english-heritage.org.uk

Dr. Hektor THOMA  
Agricultural University of Tirana  
Faculty of Forestry Sciences  
Department of Wood Industry  
Kamez, Tirana  
Albania  
Mob.: +355 682097858  
hektor\_thoma@hotmail.com

Prof. Marco TOGNI  
University of Florence  
DEISTAF - Department of Agricultural and Forest Economics, Engineering, Sciences  
and Technologies  
Division of Forest Environmental Sciences and Technologies  
13 Via San Bonaventura - 50145 FIRENZE (Italia)  
Tel. +39 055 3288 608 Fax +39 055 319 179 Mobile +39 328 4652822  
marco.togni@unifi.it

Dr. Vivi TORNARI  
Foundation for Research and Technology - FORTH  
Institute of Electronic Structure and Laser- IESL  
100 N. PLASTIRA, VOUTES71110 Heraklion, Crete  
Greece  
vivitor@iesl.forth.gr

Manuel TOUZA  
Head of Innovation and Technology Department  
Galician Timber Technological Innovation and Services Centre (CIS-Madera)  
Avda. de Galicia, 5  
Parque Tecnolóxico de Galicia  
E-32901 San Cibrao das Viñas - OURENSE  
Tfno: + 34 -988 368 152 / Fax: + -34 988 368 153  
mtv@cismadeira.com

Khôi TRAN  
CEA-Grenoble  
ARC-Nucléart Conservation Laboratory  
17, rue des Martyrs  
F-38 054 Grenoble Cedex 09  
Tel +33 - 4 3878 3936  
Fax +33 - 4 3878 5089  
Mob +33 - 6 2753 9319  
quoc-khoi.tran@cea.fr

Dipl. -Ing. Florian TSCHERNE  
HOLZFORSCHUNG AUSTRIA  
Forschungsinstitut und akkreditierte Pruef- und Ueberwachungsstelle  
A-1030 Wien, Franz Grill-Strasse 7  
Tel.: +43-1/798 26 23-15  
Fax: +43-1/798 26 23-50  
f.tscherne@holzforschung.at  
<http://www.holzforschung.at>

Prof. Ing. Luca UZIELLI  
Professor of Wood Technology  
University of Florence  
DEISTAF - Department of Agricultural and Forest Economics, Engineering, Sciences  
and Technologies  
Division of Forest Environmental Sciences and Technologies  
13 Via San Bonaventura - 50145 FIRENZE (Italia)  
Tel. +39 055 3288 668 Fax +39 055 319 179 Mobile +39 335 69 22 744  
luca.uzielli@unifi.it  
<http://www.unifi.it/distaf/>



Prof. Joris VAN ACKER  
Ghent University (UGent)  
Laboratory of Wood Technology  
Coupure links 653  
9000 Gent, Belgium  
Tel +32 – 9 264 6120  
Fax +32 – 9 264 6233  
Joris.VanAcker@ugent.be

János VERES  
Site's chief archaeologist and project coordinator Herman Ottó Museum, Miskolc  
Herman Ottó Museum  
Pf.4 - 3501 Miskolc  
Hungary  
veresj@hermuz.hu  
<http://www.hermuz.hu/>

Franco ZANINI  
Elettra - Sincrotrone Trieste  
Strada Statale 14 - km 163,5 in AREA Science Park  
34149 Basovizza, Trieste ITALY  
Phone +39.040.375.8096  
Fax +39.040.375.8558  
franco.zanini@elettra.trieste.it

Dr Magdalena ZBOROWSKA  
University of Life Sciences in Poznan  
Institute of Chemical Wood Technology  
38/42 Wojska Polskiego St.  
PL - 60637 Poznan  
POLAND  
ph.:+48 61 848 7462  
fax.:+48 61 848 7452  
mzbor@au.poznan.pl

## ANNEX 4 – LIST OF AUTHORS, AND PAGES WHERE THEIR PAPERS START

Aderhold J.	62	Mancini L.	34
Ajdinaj D.	167	Marczak J.	181
Allegretti O.	93	Markowska A.	181
Ambrosini D.	55	Mazur M.	181
Babiński L.	48	Michalcová A.	43
Baija H.	151	Moutsatsou A.P.	105
Barbu O.H.	148	Negut C.D.	148
Battault J.C.	175	Niculescu G.	115
Beraldin J.A.	69	Nilsson T.	11
Björdal Gjelstrup C.	123	Noldt U.	71
Blais F.	69	Novotná M.	43
Bratasz L.	127	Nunes L.	161
Brocke H.	62	Obataya E.	16
Bucciardini I.	193	Ohlídalová M.	43
Bushati E.	167	Olafsdottir J.	105
Calzada E.	80	Ollivier F.	175
Capretti P.	24	Petrou M.D.	28
Chmielewski K.	110, 181	Ponta C.C.	148
Ciatti M.	133	Prądzynski W.	48
Cinteza L.O.	115	Quku D.	167
Costa M.F.M.	100	Raffaelli F.	93
Çota H.	167	Ratuszna J.	144
Cruz H.	161	Rigon L.	34
Czernichowska J.	181	Rioux M.	69
de Brito J.	161	Rowell R.	11
Dionisi-Vici P.	193	Scala A.	24
Doulgeridis M.	105	Schillinger B.	80
Dreossi D.	34	Scudieri M.	191
Favretto S.	34	Sodini N.	34
Fioravanti M.	34, 193	Strzelec M.	181
Frelat J.	175	Tanac Zeren M.	153
Georgescu R.M.	148	Thoma H.	167
Groves R.M.	105	Thompson G.B.	28
Henriques D.F.	161	Tornari V.	105
Janaway R.C.	28	Tran K.	86
Jeżewska E.	137	Tromba G.	34
Koss A.	181	Trompeta M.	105
Kouloumpi E.	105	Tsaroucha C.	105
Kozłowski R.	127	Uchman-Laskowska I.	181
Kučerová I.	43, 80	Uzielli L.	193
Laloue C.	175	Vaiedelich S.	175
Lato E.	167	Veres J.	40
Le Moyne S.	175	Waliszewska B.	48
Leconte S.	175	Wilson A.S.	28
Lehmann E.	80	Yılmaz Karaman O.	157
Ley D.	175	Zanini F.	34
Lubryczyńska M.	181	Zborowska M.	48
Luchi N.	24		

