

MIT CRITICAL DATA



# Secondary Analysis of Electronic Health Records

**EXTRAS ONLINE**

 Springer Open

# Secondary Analysis of Electronic Health Records

MIT Critical Data

# Secondary Analysis of Electronic Health Records

 Springer Open

MIT Critical Data  
Massachusetts Institute of Technology  
Cambridge, MA  
USA

Additional material to this book can be downloaded from <http://link.springer.com/978-3-319-43740-8>.

ISBN 978-3-319-43740-8                      ISBN 978-3-319-43742-2 (eBook)  
DOI 10.1007/978-3-319-43742-2

Library of Congress Control Number: 2016947212

© The Editor(s) (if applicable) and The Author(s) 2016 This book is published open access.

**Open Access** This book is distributed under the terms of the Creative Commons Attribution-NonCommercial 4.0 International License (<http://creativecommons.org/licenses/by-nc/4.0/>), which permits any noncommercial use, duplication, adaptation, distribution and reproduction in any medium or format, as long as you give appropriate credit to the original author(s) and the source, a link is provided to the Creative Commons license and any changes made are indicated.

The images or other third party material in this book are included in the work's Creative Commons license, unless indicated otherwise in the credit line; if such material is not included in the work's Creative Commons license and the respective action is not permitted by statutory regulation, users will need to obtain permission from the license holder to duplicate, adapt or reproduce the material.

The use of general descriptive names, registered names, trademarks, service marks, etc. in this publication does not imply, even in the absence of a specific statement, that such names are exempt from the relevant protective laws and regulations and therefore free for general use.

The publisher, the authors and the editors are safe to assume that the advice and information in this book are believed to be true and accurate at the date of publication. Neither the publisher nor the authors or the editors give a warranty, express or implied, with respect to the material contained herein or for any errors or omissions that may have been made.

Printed on acid-free paper

This Springer imprint is published by Springer Nature  
The registered company is Springer International Publishing AG  
The registered company address is: Gewerbestrasse 11, 6330 Cham, Switzerland

# Preface

Diagnostic and therapeutic technologies continue to evolve rapidly, and both individual practitioners and clinical teams face increasingly complex decisions. Unfortunately, the current state of medical knowledge does not provide the guidance to make the majority of clinical decisions on the basis of evidence. According to the 2012 Institute of Medicine Committee Report, only 10–20 % of clinical decisions are evidence based. The problem even extends to the creation of clinical practice guidelines (CPGs). Nearly 50 % of recommendations made in specialty society guidelines rely on expert opinion rather than experimental data. Furthermore, the creation process of CPGs is “marred by weak methods and financial conflicts of interest,” rendering current CPGs potentially less trustworthy.

The present research infrastructure is inefficient and frequently produces unreliable results that cannot be replicated. Even randomized controlled trials (RCTs), the traditional gold standards of the research reliability hierarchy, are not without limitations. They can be costly, labor-intensive, slow, and can return results that are seldom generalizable to every patient population. It is impossible for a tightly controlled RCT to capture the full, interactive, and contextual details of the clinical issues that arise in real clinics and inpatient units. Furthermore, many pertinent but unresolved clinical and medical systems issues do not seem to have attracted the interest of the research enterprise, which has come to focus instead on cellular and molecular investigations and single-agent (e.g., a drug or device) effects. For clinicians, the end result is a “data desert” when it comes to making decisions.

Electronic health record (EHR) data are frequently digitally archived and can subsequently be extracted and analyzed. Between 2011 and 2019, the prevalence of EHRs is expected to grow from 34 to 90 % among office-based practices, and the majority of hospitals have replaced or are in the process of replacing paper systems with comprehensive, enterprise EHRs. The power of scale intrinsic to this digital transformation opens the door to a massive amount of currently untapped information. The data, if properly analyzed and meaningfully interpreted, could vastly improve our conception and development of best practices. The possibilities for quality improvement, increased safety, process optimization, and personalization of clinical decisions range from impressive to revolutionary. The National Institutes of

Health (NIH) and other major grant organizations have begun to recognize the power of big data in knowledge creation and are offering grants to support investigators in this area.

This book, written with support from the National Institute for Biomedical Imaging and Bioengineering through grant R01 EB017205-01A1, is meant to serve as an illustrative guide for scientists, engineers, and clinicians that are interested in performing retrospective research using data from EHRs. It is divided into three major parts.

The first part of the book paints the current landscape and describes the body of knowledge that dictates clinical practice guidelines, including the limitations and the challenges. This sets the stage for presenting the motivation behind the secondary analysis of EHR data. The part also describes the data landscape, who the key players are, and which types of databases are useful for which kinds of questions. Finally, the part outlines the political, regulatory and technical challenges faced by clinical informaticians, and provides suggestions on how to navigate through these challenges.

In the second part, the process of parsing a clinical question into a study design and methodology is broken down into five steps. The first step explains how to formulate the right research question, and bring together the appropriate team. The second step outlines strategies for identifying, extracting, Oxford, and preprocessing EHR data to comprehend and address the research question of interest. The third step presents techniques in exploratory analysis and data visualization. In the fourth step, a detailed guide on how to choose the type of analysis that best answers the research question is provided. Finally, the fifth and final step illustrates how to validate results, using cross validation, sensitivity analyses, testing of falsification hypotheses, and other common techniques in the field.

The third, and final part of the book, provides a comprehensive collection of case studies. These case studies highlight various aspects of the research pipeline presented in the second part of the book, and help ground the reader in real world data analyses.

We have written the book so that a reader at different levels may easily start at different parts. For the novice researcher, the book should be read from start to finish. For individuals who are already acquainted with the challenges of clinical informatics, but would like guidance on how to most effectively perform the analysis, the book should be read from the second part onward. Finally, the part on case studies provides project-specific practical considerations on study design and methodology and is recommended for all readers.

The time has come to leverage the data we generate during routine patient care to formulate a more complete lexicon of evidence-based recommendations and support shared decision making with patients. This book will train the next generation of scientists, representing different disciplines, but collaborating to expand the knowledge base that will guide medical practice in the future.

We would like to take this opportunity to thank Professor Roger Mark, whose vision to create a high resolution clinical database that is open to investigators around the world, inspired us to write this textbook.

# MIT Critical Data

MIT Critical Data consists of data scientists and clinicians from around the globe brought together by a vision to engender a data-driven healthcare system supported by *clinical informatics without walls*. In this ecosystem, the creation of evidence and clinical decision support tools is initiated, updated, honed, Oxford, and enhanced by scaling the access to and meaningful use of clinical data.

**Leo Anthony Celi** has practiced medicine in three continents, giving him broad perspectives in healthcare delivery. His research is on secondary analysis of electronic health records and global health informatics. He founded and co-directs Sana at the Institute for Medical Engineering and Science at the Massachusetts Institute of Technology. He also holds a faculty position at Harvard Medical School as an intensivist at the Beth Israel Deaconess Medical Center and is the clinical research director for the Laboratory of Computational Physiology at MIT. Finally, he is one of the course directors for HST.936 at MIT—innovations in global health informatics and HST.953—secondary analysis of electronic health records.

**Peter Charlton** gained the degree of M.Eng. in Engineering Science in 2010 from the University of Oxford. Since then he held a research position, working jointly with Guy's and St Thomas' NHS Foundation Trust, and King's College London. Peter's research focuses on physiological monitoring of hospital patients, divided into three areas. The first area concerns the development of signal processing techniques to estimate clinical parameters from physiological signals. He has focused on unobtrusive estimation of respiratory rate for use in ambulatory settings, invasive estimation of cardiac output for use in critical care, and novel techniques for analysis of the pulse oximetry (photoplethysmogram) signal. Secondly, he is investigating the effectiveness of technologies for the acquisition of continuous and intermittent physiological measurements in ambulatory and intensive care settings. Thirdly, he is developing techniques to transform continuous monitoring data into measurements that are appropriate for real-time alerting of patient deteriorations.

**Mohammad Mahdi Ghassemi** is a doctoral candidate at the Massachusetts Institute of Technology. As an undergraduate, he studied Electrical Engineering and graduated as both a Goldwater scholar and the University's "Outstanding

Engineer”. In 2011, Mohammad received an MPhil in Information Engineering from the University of Cambridge where he was also a recipient of the Gates-Cambridge Scholarship. Since arriving at MIT, he has pursued research at the interface of machine learning and medical informatics. Mohammad’s doctoral focus is on signal processing and machine learning techniques in the context of multi-modal, multiscale datasets. He has helped put together the largest collection of post-anoxic coma EEGs in the world. In addition to his thesis work, Mohammad has worked with the Samsung Corporation, and several entities across campus building “smart devices” including: a multi-sensor wearable that passively monitors the physiological, audio and video activity of a user to estimate a latent emotional state.

**Alistair Johnson** received his B.Eng. in Biomedical and Electrical Engineering at McMaster University, Canada, and subsequently read for a DPhil in Healthcare Innovation at the University of Oxford. His thesis was titled “Mortality and acuity assessment in critical care”, and its focus included using machine learning techniques to predict mortality and develop new severity of illness scores for patients admitted to intensive care units. Alistair also spent a year as a research assistant at the John Radcliffe hospital in Oxford, where he worked on building early alerting models for patients post-ICU discharge. Alistair’s research interests revolve around the use of data collected during routine clinical practice to improve patient care.

**Matthieu Komorowski** holds board certification in anesthesiology and critical care in both France and the UK. A former medical research fellow at the European Space Agency, he completed a Master of Research in Biomedical Engineering at Imperial College London focusing on machine learning. Dr Komorowski now pursues a Ph.D. at Imperial College and a research fellowship in intensive care at Charing Cross Hospital in London. In his research, he combines his expertise in machine learning and critical care to generate new clinical evidence and build the next generation of clinical tools such as decision support systems, with a particular interest in septic shock, the number one killer in intensive care and the single most expensive condition treated in hospitals.

**Dominic Marshall** is an Academic Foundation doctor in Oxford, UK. Dominic read Molecular and Cellular biology at the University of Bath and worked at Eli Lilly in their Alzheimer’s disease drug hunting research program. He pursued his medical training at Imperial College London where he was awarded the Santander Undergraduate scholarship for academic performance and ranked first overall in his graduating class. His research interests range from molecular biology to analysis of large clinical data sets and he has received non-industry grant funding to pursue the development of novel antibiotics and chemotherapeutic agents. Alongside clinical training, he is involved in a number of research projects focusing on analysis of electronic health care records.

**Tristan Naumann** is a doctoral candidate in Electrical Engineering and Computer Science at MIT working with Dr. Peter Szolovits in CSAIL’s Clinical Decision Making group. His research includes exploring relationships in complex,



unstructured data using data-informed unsupervised learning techniques, and the application of natural language processing techniques in healthcare data. He has been an organizer for workshops and “datathon” events, which bring together participants with diverse backgrounds in order to address biomedical and clinical questions in a manner that is reliable and reproducible.

**Kenneth Paik** is a clinical informatician democratizing access “to healthcare” through technology innovation, with his multidisciplinary background in medicine, artificial intelligence, business management, and technology strategy. He is a research scientist at the MIT Laboratory for Computational Physiology investigating the secondary analysis of health data and building intelligent decision support system. As the co-director of Sana, he leads programs and projects driving quality improvement and building capacity in global health. He received his MD and MBA degrees from Georgetown University and completed fellowship training in biomedical informatics at Harvard Medical School and the Massachusetts General Hospital Laboratory for Computer Science.

**Tom Joseph Pollard** is a postdoctoral associate at the MIT Laboratory for Computational Physiology. Most recently he has been working with colleagues to release MIMIC-III, an openly accessible critical care database. Prior to joining MIT in 2015, Tom completed his Ph.D. at University College London, UK, where he explored models of health in critical care patients in an interdisciplinary project between the Mullard Space Science Laboratory and University College Hospital. Tom has a broad interest in improving the way clinical data is managed, shared, and analyzed for the benefit of patients. He is a Fellow of the Software Sustainability Institute.

**Jesse Raffa** is a research scientist in the Laboratory for Computational Physiology at the Massachusetts Institute of Technology in Cambridge, USA. He received his Ph.D. in biostatistics from the University of Waterloo (Canada) in 2013. His primary methodological interests are related to the modeling of complex longitudinal data, latent variable models and reproducible research. In addition to his methodological contributions, he has collaborated and published over 20 academic articles with colleagues in a diverse set of areas including: infectious diseases, addiction and critical care, among others. Jesse was the recipient of the distinguished student paper award at the Eastern North American Region International Biometric Society conference in 2013, and the new investigator of the year for the Canadian Association of HIV/AIDS Research in 2004.

**Justin Saliccioli** is an Academic Foundation doctor in London, UK. Originally from Toronto, Canada, Justin completed his undergraduate and graduate studies in the United States before pursuing his medical studies at Imperial College London. His research pursuits started as an undergraduate student while completing a biochemistry degree. Subsequently, he worked on clinical trials in emergency medicine and intensive care medicine at Beth Israel Deaconess Medical Center in Boston and completed a Masters degree with his thesis on vitamin D deficiency in critically ill patients with sepsis. During this time he developed a keen interest in statistical

methods and programming particularly in SAS and R. He has co-authored more than 30 peer-reviewed manuscripts and, in addition to his current clinical training, continues with his research interests on analytical methods for observational and clinical trial data as well as education in data analytics for medical students and clinicians.

# Contents

## Part I Setting the Stage: Rationale Behind and Challenges to Health Data Analysis

<b>1</b>	<b>Objectives of the Secondary Analysis of Electronic Health Record Data</b> . . . . .	3
1.1	Introduction . . . . .	3
1.2	Current Research Climate . . . . .	3
1.3	Power of the Electronic Health Record . . . . .	4
1.4	Pitfalls and Challenges . . . . .	5
1.5	Conclusion . . . . .	6
	References . . . . .	7
<b>2</b>	<b>Review of Clinical Databases</b> . . . . .	9
2.1	Introduction . . . . .	9
2.2	Background . . . . .	9
2.3	The Medical Information Mart for Intensive Care (MIMIC) Database . . . . .	10
2.3.1	Included Variables . . . . .	11
2.3.2	Access and Interface . . . . .	12
2.4	PCORnet . . . . .	12
2.4.1	Included Variables . . . . .	12
2.4.2	Access and Interface . . . . .	13
2.5	Open NHS . . . . .	13
2.5.1	Included Variables . . . . .	13
2.5.2	Access and Interface . . . . .	13
2.6	Other Ongoing Research . . . . .	14
2.6.1	eICU—Philips . . . . .	14
2.6.2	VistA . . . . .	14
2.6.3	NSQUIP . . . . .	15
	References . . . . .	16

- 3 Challenges and Opportunities in Secondary Analyses of Electronic Health Record Data** . . . . . 17
  - 3.1 Introduction . . . . . 17
  - 3.2 Challenges in Secondary Analysis of Electronic Health Records Data . . . . . 17
  - 3.3 Opportunities in Secondary Analysis of Electronic Health Records Data . . . . . 20
  - 3.4 Secondary EHR Analyses as Alternatives to Randomized Controlled Clinical Trials . . . . . 21
  - 3.5 Demonstrating the Power of Secondary EHR Analysis: Examples in Pharmacovigilance and Clinical Care . . . . . 22
  - 3.6 A New Paradigm for Supporting Evidence-Based Practice and Ethical Considerations . . . . . 23
  - References. . . . . 25
- 4 Pulling It All Together: Envisioning a Data-Driven, Ideal Care System** . . . . . 27
  - 4.1 Use Case Examples Based on Unavoidable Medical Heterogeneity . . . . . 28
  - 4.2 Clinical Workflow, Documentation, and Decisions . . . . . 29
  - 4.3 Levels of Precision and Personalization . . . . . 32
  - 4.4 Coordination, Communication, and Guidance Through the Clinical Labyrinth. . . . . 35
  - 4.5 Safety and Quality in an ICS . . . . . 36
  - 4.6 Conclusion . . . . . 39
  - References. . . . . 41
- 5 The Story of MIMIC** . . . . . 43
  - 5.1 The Vision . . . . . 43
  - 5.2 Data Acquisition . . . . . 44
    - 5.2.1 Clinical Data . . . . . 44
    - 5.2.2 Physiological Data . . . . . 45
    - 5.2.3 Death Data. . . . . 46
  - 5.3 Data Merger and Organization . . . . . 46
  - 5.4 Data Sharing . . . . . 47
  - 5.5 Updating . . . . . 47
  - 5.6 Support . . . . . 48
  - 5.7 Lessons Learned . . . . . 48
  - 5.8 Future Directions . . . . . 49
  - References. . . . . 49
- 6 Integrating Non-clinical Data with EHRs** . . . . . 51
  - 6.1 Introduction . . . . . 51
  - 6.2 Non-clinical Factors and Determinants of Health . . . . . 51
  - 6.3 Increasing Data Availability . . . . . 53
  - 6.4 Integration, Application and Calibration . . . . . 54

6.5 A Well-Connected Empowerment. . . . . 57

6.6 Conclusion . . . . . 58

References. . . . . 59

**7 Using EHR to Conduct Outcome and Health Services Research. . . . . 61**

7.1 Introduction . . . . . 61

7.2 The Rise of EHRs in Health Services Research . . . . . 62

7.2.1 The EHR in Outcomes and Observational Studies. . . . . 62

7.2.2 The EHR as Tool to Facilitate Patient Enrollment in Prospective Trials . . . . . 63

7.2.3 The EHR as Tool to Study and Improve Patient Outcomes. . . . . 64

7.3 How to Avoid Common Pitfalls When Using EHR to Do Health Services Research . . . . . 64

7.3.1 Step 1: Recognize the Fallibility of the EHR. . . . . 65

7.3.2 Step 2: Understand Confounding, Bias, and Missing Data When Using the EHR for Research . . . . . 65

7.4 Future Directions for the EHR and Health Services Research. . . . . 67

7.4.1 Ensuring Adequate Patient Privacy Protection. . . . . 67

7.5 Multidimensional Collaborations. . . . . 67

7.6 Conclusion . . . . . 68

References. . . . . 68

**8 Residual Confounding Lurking in Big Data: A Source of Error . . . . . 71**

8.1 Introduction . . . . . 71

8.2 Confounding Variables in Big Data . . . . . 72

8.2.1 The Obesity Paradox. . . . . 72

8.2.2 Selection Bias . . . . . 73

8.2.3 Uncertain Pathophysiology . . . . . 74

8.3 Conclusion . . . . . 77

References. . . . . 77

**Part II A Cookbook: From Research Question Formulation to Validation of Findings**

**9 Formulating the Research Question. . . . . 81**

9.1 Introduction . . . . . 81

9.2 The Clinical Scenario: Impact of Indwelling Arterial Catheters. . . . . 82

9.3 Turning Clinical Questions into Research Questions. . . . . 82

9.3.1 Study Sample . . . . . 82

9.3.2	Exposure . . . . .	83
9.3.3	Outcome . . . . .	84
9.4	Matching Study Design to the Research Question . . . . .	85
9.5	Types of Observational Research . . . . .	87
9.6	Choosing the Right Database . . . . .	89
9.7	Putting It Together . . . . .	90
	References. . . . .	91
<b>10</b>	<b>Defining the Patient Cohort . . . . .</b>	<b>93</b>
10.1	Introduction . . . . .	93
10.2	PART 1—Theoretical Concepts . . . . .	94
10.2.1	Exposure and Outcome of Interest. . . . .	94
10.2.2	Comparison Group . . . . .	95
10.2.3	Building the Study Cohort. . . . .	95
10.2.4	Hidden Exposures . . . . .	97
10.2.5	Data Visualization . . . . .	97
10.2.6	Study Cohort Fidelity . . . . .	98
10.3	PART 2—Case Study: Cohort Selection. . . . .	98
	References. . . . .	100
<b>11</b>	<b>Data Preparation. . . . .</b>	<b>101</b>
11.1	Introduction . . . . .	101
11.2	Part 1—Theoretical Concepts . . . . .	102
11.2.1	Categories of Hospital Data. . . . .	102
11.2.2	Context and Collaboration . . . . .	103
11.2.3	Quantitative and Qualitative Data . . . . .	104
11.2.4	Data Files and Databases. . . . .	104
11.2.5	Reproducibility . . . . .	107
11.3	Part 2—Practical Examples of Data Preparation . . . . .	109
11.3.1	MIMIC Tables. . . . .	109
11.3.2	SQL Basics . . . . .	109
11.3.3	Joins . . . . .	112
11.3.4	Ranking Across Rows Using a Window Function . . . . .	113
11.3.5	Making Queries More Manageable Using WITH . . . . .	113
	References. . . . .	114
<b>12</b>	<b>Data Pre-processing. . . . .</b>	<b>115</b>
12.1	Introduction . . . . .	115
12.2	Part 1—Theoretical Concepts . . . . .	116
12.2.1	Data Cleaning . . . . .	116
12.2.2	Data Integration. . . . .	118
12.2.3	Data Transformation . . . . .	119
12.2.4	Data Reduction . . . . .	120

12.3	PART 2—Examples of Data Pre-processing in R . . . . .	121
12.3.1	R—The Basics . . . . .	121
12.3.2	Data Integration . . . . .	129
12.3.3	Data Transformation . . . . .	132
12.3.4	Data Reduction . . . . .	136
12.4	Conclusion . . . . .	140
	References . . . . .	141
<b>13</b>	<b>Missing Data . . . . .</b>	<b>143</b>
13.1	Introduction . . . . .	143
13.2	Part 1—Theoretical Concepts . . . . .	144
13.2.1	Types of Missingness . . . . .	144
13.2.2	Proportion of Missing Data . . . . .	146
13.2.3	Dealing with Missing Data . . . . .	146
13.2.4	Choice of the Best Imputation Method . . . . .	152
13.3	Part 2—Case Study . . . . .	153
13.3.1	Proportion of Missing Data and Possible Reasons for Missingness . . . . .	153
13.3.2	Univariate Missingness Analysis . . . . .	154
13.3.3	Evaluating the Performance of Imputation Methods on Mortality Prediction . . . . .	159
13.4	Conclusion . . . . .	161
	References . . . . .	161
<b>14</b>	<b>Noise Versus Outliers . . . . .</b>	<b>163</b>
14.1	Introduction . . . . .	163
14.2	Part 1—Theoretical Concepts . . . . .	164
14.3	Statistical Methods . . . . .	165
14.3.1	Tukey’s Method . . . . .	166
14.3.2	Z-Score . . . . .	166
14.3.3	Modified Z-Score . . . . .	166
14.3.4	Interquartile Range with Log-Normal Distribution . . . . .	167
14.3.5	Ordinary and Studentized Residuals . . . . .	167
14.3.6	Cook’s Distance . . . . .	167
14.3.7	Mahalanobis Distance . . . . .	168
14.4	Proximity Based Models . . . . .	168
14.4.1	k-Means . . . . .	169
14.4.2	k-Medoids . . . . .	169
14.4.3	Criteria for Outlier Detection . . . . .	169
14.5	Supervised Outlier Detection . . . . .	171
14.6	Outlier Analysis Using Expert Knowledge . . . . .	171
14.7	Case Study: Identification of Outliers in the Indwelling Arterial Catheter (IAC) Study . . . . .	171
14.8	Expert Knowledge Analysis . . . . .	172

- 14.9 Univariate Analysis . . . . . 172
- 14.10 Multivariable Analysis . . . . . 177
- 14.11 Classification of Mortality in IAC and Non-IAC Patients . . . . . 179
- 14.12 Conclusions and Summary . . . . . 181
- Code Appendix . . . . . 182
- References. . . . . 183
- 15 Exploratory Data Analysis . . . . . 185**
  - 15.1 Introduction . . . . . 185
  - 15.2 Part 1—Theoretical Concepts . . . . . 186
    - 15.2.1 Suggested EDA Techniques. . . . . 186
    - 15.2.2 Non-graphical EDA. . . . . 187
    - 15.2.3 Graphical EDA . . . . . 191
  - 15.3 Part 2—Case Study. . . . . 199
    - 15.3.1 Non-graphical EDA. . . . . 199
    - 15.3.2 Graphical EDA . . . . . 200
  - 15.4 Conclusion . . . . . 202
  - Code Appendix . . . . . 202
  - References. . . . . 203
- 16 Data Analysis. . . . . 205**
  - 16.1 Introduction to Data Analysis . . . . . 205
    - 16.1.1 Introduction. . . . . 205
    - 16.1.2 Identifying Data Types and Study Objectives . . . . . 206
    - 16.1.3 Case Study Data . . . . . 209
  - 16.2 Linear Regression . . . . . 210
    - 16.2.1 Section Goals. . . . . 210
    - 16.2.2 Introduction . . . . . 210
    - 16.2.3 Model Selection. . . . . 213
    - 16.2.4 Reporting and Interpreting Linear Regression . . . . . 220
    - 16.2.5 Caveats and Conclusions . . . . . 223
  - 16.3 Logistic Regression. . . . . 224
    - 16.3.1 Section Goals. . . . . 224
    - 16.3.2 Introduction . . . . . 225
    - 16.3.3  $2 \times 2$  Tables . . . . . 225
    - 16.3.4 Introducing Logistic Regression. . . . . 227
    - 16.3.5 Hypothesis Testing and Model Selection . . . . . 232
    - 16.3.6 Confidence Intervals . . . . . 233
    - 16.3.7 Prediction . . . . . 234
    - 16.3.8 Presenting and Interpreting Logistic Regression  
Analysis. . . . . 235
    - 16.3.9 Caveats and Conclusions . . . . . 236
  - 16.4 Survival Analysis . . . . . 237
    - 16.4.1 Section Goals. . . . . 237
    - 16.4.2 Introduction . . . . . 237



- 16.4.3 Kaplan-Meier Survival Curves. . . . . 238
- 16.4.4 Cox Proportional Hazards Models. . . . . 240
- 16.4.5 Caveats and Conclusions. . . . . 243
- 16.5 Case Study and Summary. . . . . 244
  - 16.5.1 Section Goals. . . . . 244
  - 16.5.2 Introduction. . . . . 244
  - 16.5.3 Logistic Regression Analysis. . . . . 250
  - 16.5.4 Conclusion and Summary. . . . . 259
- References. . . . . 261
- 17 Sensitivity Analysis and Model Validation. . . . . 263**
  - 17.1 Introduction . . . . . 263
  - 17.2 Part 1—Theoretical Concepts . . . . . 264
    - 17.2.1 Bias and Variance . . . . . 264
    - 17.2.2 Common Evaluation Tools . . . . . 265
    - 17.2.3 Sensitivity Analysis. . . . . 265
    - 17.2.4 Validation . . . . . 266
  - 17.3 Case Study: Examples of Validation and Sensitivity Analysis . . . . . 267
    - 17.3.1 Analysis 1: Varying the Inclusion Criteria of Time to Mechanical Ventilation . . . . . 267
    - 17.3.2 Analysis 2: Changing the Caliper Level for Propensity Matching . . . . . 268
    - 17.3.3 Analysis 3: Hosmer-Lemeshow Test . . . . . 269
    - 17.3.4 Implications for a ‘Failing’ Model. . . . . 269
  - 17.4 Conclusion . . . . . 270
  - Code Appendix . . . . . 270
  - References. . . . . 271

**Part III Case Studies Using MIMIC**

- 18 Trend Analysis: Evolution of Tidal Volume Over Time for Patients Receiving Invasive Mechanical Ventilation . . . . . 275**
  - 18.1 Introduction . . . . . 275
  - 18.2 Study Dataset . . . . . 277
  - 18.3 Study Pre-processing. . . . . 277
  - 18.4 Study Methods . . . . . 277
  - 18.5 Study Analysis . . . . . 278
  - 18.6 Study Conclusions . . . . . 280
  - 18.7 Next Steps . . . . . 280
  - 18.8 Connections . . . . . 281
  - Code Appendix . . . . . 282
  - References. . . . . 282

- 19 Instrumental Variable Analysis of Electronic Health Records . . . . .** 285
  - 19.1 Introduction . . . . . 285
  - 19.2 Methods . . . . . 287
    - 19.2.1 Dataset. . . . . 287
    - 19.2.2 Methodology . . . . . 287
    - 19.2.3 Pre-processing . . . . . 290
  - 19.3 Results . . . . . 291
  - 19.4 Next Steps . . . . . 292
  - 19.5 Conclusions . . . . . 293
  - Code Appendix . . . . . 293
  - References. . . . . 293
  
- 20 Mortality Prediction in the ICU Based on MIMIC-II Results  
from the Super ICU Learner Algorithm (SICULA) Project . . . . .** 295
  - 20.1 Introduction . . . . . 295
  - 20.2 Dataset and Pre-preprocessing. . . . . 297
    - 20.2.1 Data Collection and Patients Characteristics . . . . . 297
    - 20.2.2 Patient Inclusion and Measures . . . . . 297
  - 20.3 Methods . . . . . 299
    - 20.3.1 Prediction Algorithms . . . . . 299
    - 20.3.2 Performance Metrics . . . . . 301
  - 20.4 Analysis . . . . . 302
    - 20.4.1 Discrimination . . . . . 302
    - 20.4.2 Calibration. . . . . 303
    - 20.4.3 Super Learner Library . . . . . 305
    - 20.4.4 Reclassification Tables. . . . . 305
  - 20.5 Discussion. . . . . 308
  - 20.6 What Are the Next Steps? . . . . . 309
  - 20.7 Conclusions . . . . . 309
  - Code Appendix . . . . . 310
  - References. . . . . 311
  
- 21 Mortality Prediction in the ICU . . . . .** 315
  - 21.1 Introduction . . . . . 315
  - 21.2 Study Dataset . . . . . 316
  - 21.3 Pre-processing . . . . . 317
  - 21.4 Methods . . . . . 318
  - 21.5 Analysis . . . . . 319
  - 21.6 Visualization. . . . . 319
  - 21.7 Conclusions . . . . . 321
  - 21.8 Next Steps . . . . . 321
  - 21.9 Connections . . . . . 322
  - Code Appendix . . . . . 323
  - References. . . . . 323

- 22 Data Fusion Techniques for Early Warning of Clinical Deterioration** . . . . . 325
  - 22.1 Introduction . . . . . 325
  - 22.2 Study Dataset . . . . . 326
  - 22.3 Pre-processing . . . . . 327
  - 22.4 Methods . . . . . 328
  - 22.5 Analysis . . . . . 330
  - 22.6 Discussion. . . . . 333
  - 22.7 Conclusions . . . . . 335
  - 22.8 Further Work . . . . . 335
  - 22.9 Personalised Prediction of Deteriorations . . . . . 336
  - Code Appendix . . . . . 337
  - References. . . . . 337
  
- 23 Comparative Effectiveness: Propensity Score Analysis** . . . . . 339
  - 23.1 Incentives for Using Propensity Score Analysis . . . . . 339
  - 23.2 Concerns for Using Propensity Score . . . . . 340
  - 23.3 Different Approaches for Estimating Propensity Scores . . . . . 340
  - 23.4 Using Propensity Score to Adjust for Pre-treatment Conditions . . . . . 341
  - 23.5 Study Pre-processing. . . . . 343
  - 23.6 Study Analysis . . . . . 346
  - 23.7 Study Results . . . . . 346
  - 23.8 Conclusions . . . . . 347
  - 23.9 Next Steps . . . . . 347
  - Code Appendix . . . . . 348
  - References. . . . . 348
  
- 24 Markov Models and Cost Effectiveness Analysis: Applications in Medical Research** . . . . . 351
  - 24.1 Introduction . . . . . 351
  - 24.2 Formalization of Common Markov Models . . . . . 352
    - 24.2.1 The Markov Chain . . . . . 352
    - 24.2.2 Exploring Markov Chains with Monte Carlo Simulations . . . . . 353
    - 24.2.3 Markov Decision Process and Hidden Markov Models. . . . . 355
    - 24.2.4 Medical Applications of Markov Models. . . . . 356
  - 24.3 Basics of Health Economics . . . . . 356
    - 24.3.1 The Goal of Health Economics: Maximizing Cost-Effectiveness . . . . . 356
    - 24.3.2 Definitions . . . . . 357
  - 24.4 Case Study: Monte Carlo Simulations of a Markov Chain for Daily Sedation Holds in Intensive Care, with Cost-Effectiveness Analysis . . . . . 359

24.5	Model Validation and Sensitivity Analysis for Cost-Effectiveness Analysis . . . . .	364
24.6	Conclusion . . . . .	365
24.7	Next Steps . . . . .	366
	Code Appendix . . . . .	366
	References. . . . .	366
<b>25</b>	<b>Blood Pressure and the Risk of Acute Kidney Injury in the ICU: Case-Control Versus Case-Crossover Designs . . . . .</b>	<b>369</b>
25.1	Introduction . . . . .	369
25.2	Methods . . . . .	370
	25.2.1 Data Pre-processing . . . . .	370
	25.2.2 A Case-Control Study . . . . .	370
	25.2.3 A Case-Crossover Design . . . . .	372
25.3	Discussion. . . . .	374
25.4	Conclusions . . . . .	374
	Code Appendix . . . . .	375
	References. . . . .	375
<b>26</b>	<b>Waveform Analysis to Estimate Respiratory Rate . . . . .</b>	<b>377</b>
26.1	Introduction . . . . .	377
26.2	Study Dataset . . . . .	378
26.3	Pre-processing . . . . .	380
26.4	Methods . . . . .	381
26.5	Results . . . . .	384
26.6	Discussion. . . . .	385
26.7	Conclusions . . . . .	386
26.8	Further Work . . . . .	386
26.9	Non-contact Vital Sign Estimation . . . . .	387
	Code Appendix . . . . .	388
	References. . . . .	389
<b>27</b>	<b>Signal Processing: False Alarm Reduction . . . . .</b>	<b>391</b>
27.1	Introduction . . . . .	391
27.2	Study Dataset . . . . .	393
27.3	Study Pre-processing. . . . .	394
27.4	Study Methods . . . . .	395
27.5	Study Analysis . . . . .	397
27.6	Study Visualizations . . . . .	398
27.7	Study Conclusions . . . . .	399
27.8	Next Steps/Potential Follow-Up Studies . . . . .	400
	References. . . . .	401

- 28 Improving Patient Cohort Identification Using Natural Language Processing . . . . . 405**
- 28.1 Introduction . . . . . 405
- 28.2 Methods . . . . . 407
  - 28.2.1 Study Dataset and Pre-processing . . . . . 407
  - 28.2.2 Structured Data Extraction from MIMIC-III Tables . . . . . 408
  - 28.2.3 Unstructured Data Extraction from Clinical Notes . . . . . 409
  - 28.2.4 Analysis . . . . . 410
- 28.3 Results . . . . . 410
- 28.4 Discussion. . . . . 413
- 28.5 Conclusions . . . . . 414
- Code Appendix . . . . . 414
- References. . . . . 415
  
- 29 Hyperparameter Selection. . . . . 419**
- 29.1 Introduction . . . . . 419
- 29.2 Study Dataset . . . . . 420
- 29.3 Study Methods . . . . . 420
- 29.4 Study Analysis . . . . . 423
- 29.5 Study Visualizations . . . . . 424
- 29.6 Study Conclusions . . . . . 425
- 29.7 Discussion. . . . . 425
- 29.8 Conclusions . . . . . 426
- References. . . . . 427
  
- Erratum to: Secondary Analysis of Electronic Health Records . . . . . E1**

# Part I

## Setting the Stage: Rationale Behind and Challenges to Health Data Analysis

### Introduction

While wonderful new medical discoveries and innovations are in the news every day, healthcare providers continue to struggle with using information. Uncertainties and unanswered clinical questions are a daily reality for the decision makers who provide care. Perhaps the biggest limitation in making the best possible decisions for patients is that the information available is usually not focused on the specific individual or situation at hand.

For example, there are general clinical guidelines that outline the ideal target blood pressure for a patient with a severe infection. However, the truly best blood pressure levels likely differ from patient to patient, and perhaps even change for an individual patient over the course of treatment. The ongoing computerization of health records presents an opportunity to overcome this limitation. By analyzing electronic data from many providers' experiences with many patients, we can move ever closer to answering the age-old question: What is truly best for each patient?

Secondary analysis of routinely collected data—contrasted with the primary analysis conducted in the process of caring for the individual patient—offers an opportunity to extract more knowledge that will lead us towards the goal of optimal care. Today, a report from the National Academy of Medicine tells us, most doctors base most of their everyday decisions on guidelines from (sometimes biased) expert opinions or small clinical trials. It would be better if they were from multi-center, large, randomized controlled studies, with tightly controlled conditions ensuring the results are as reliable as possible. However, those are expensive and difficult to perform, and even then often exclude a number of important patient groups on the basis of age, disease and sociological factors.

Part of the problem is that health records are traditionally kept on paper, making them hard to analyze en masse. As a result, most of what medical professionals might have learned from experiences is lost, or is inaccessible at least. The ideal digital system would collect and store as much clinical data as possible from as many patients as possible. It could then use information from the past—such as blood pressure, blood sugar levels, heart rate, and other measurements of patients'

body functions—to guide future providers to the best diagnosis and treatment of similar patients.

But “big data” in healthcare has been coated in “Silicon Valley Disruptionese”, the language with which Silicon Valley spins hype into startup gold and fills it with grandiose promises to lure investors and early users. The buzz phrase “precision medicine” looms large in the public consciousness with little mention of the failures of “personalized medicine”, its predecessor, behind the façade.

This part sets the stage for secondary analysis of electronic health records (EHR). Chapter 1 opens with the rationale behind this type of research. Chapter 2 provides a list of existing clinical databases already in use for research. Chapter 3 dives into the opportunities, and more importantly, the challenges to retrospective analysis of EHR. Chapter 4 presents ideas on how data could be systematically and more effectively employed in a purposefully engineered healthcare system. Professor Roger Mark, the visionary who created the Medical Information Mart for Intensive Care or MIMIC database that is used in this textbook, narrates the story behind the project in Chap. 5. Chapter 6 steps into the future and describes integration of EHR with non-clinical data for a richer representation of health and disease. Chapter 7 focuses on the role of EHR in two important areas of research—outcome and health services. Finally, Chap. 8 tackles the bane of observational studies using EHR: residual confounding.

We emphasize the importance of bringing together front-line clinicians such as nurses, pharmacists and doctors with data scientists to collaboratively identify questions and to conduct appropriate analyses. Further, we believe this research partnership of practitioner and researcher gives caregivers and patients the best individualized diagnostic and treatment options in the absence of a randomized controlled trial. By becoming more comfortable with the data available to us in the hospitals of today, we can reduce the uncertainties that have hindered healthcare for far too long.

# Chapter 1

## Objectives of the Secondary Analysis of Electronic Health Record Data

Sharukh Lokhandwala and Barret Rush

### Take Home Messages

- Clinical medicine relies on a strong research foundation in order to build the necessary evidence base to inform best practices and improve clinical care, however, large-scale randomized controlled trials (RCTs) are expensive and sometimes unfeasible. Fortunately, there exists expansive data in the form of electronic health records (EHR).
- Data can be overwhelmingly complex or incomplete for any individual, therefore we urge multidisciplinary research teams consisting of clinicians along with data scientists to unpack the clinical semantics necessary to appropriately analyze the data.

## 1.1 Introduction

The healthcare industry has rapidly become computerized and digital. Most healthcare delivered in America today relies on or utilizes technology. Modern healthcare informatics generates and stores immense amounts of detailed patient and clinical process data. Very little real-world patient data have been used to further advance the field of health care. One large barrier to the utilization of these data is inaccessibility to researchers. Making these databases easier to access as well as integrating the data would allow more researchers to answer fundamental questions of clinical care.

## 1.2 Current Research Climate

Many treatments lack proof in their efficacy, and may, in fact, cause harm [1]. Various medical societies disseminate guidelines to assist clinician decision-making and to standardize practice; however, the evidence used to formulate these guidelines is inadequate. These guidelines are also commonly derived from RCTs with



limited patient cohorts and with extensive inclusion and exclusion criteria resulting in reduced generalizability. RCTs, the gold standard in clinical research, support only 10–20 % of medical decisions [2] and most clinical decisions have never been supported by RCTs [3]. Furthermore, it would be impossible to perform randomized trials for each of the extraordinarily large number of decisions clinicians face on a daily basis in caring for patients for numerous reasons, including constrained financial and human resources. For this reason, clinicians and investigators must learn to find clinical evidence from the droves of data that already exists: the EHR.

### 1.3 Power of the Electronic Health Record

Much of the work utilizing large databases in the past 25 years have relied on hospital discharge records and registry databases. Hospital discharge databases were initially created for billing purposes and lack the patient level granularity of clinically useful, accurate, and complete data to address complex research questions. Registry databases are generally mission-limited and require extensive extracurricular data collection. The future of clinical research lies in utilizing big data to improve the delivery of care to patients.

Although several commercial and non-commercial databases have been created using clinical and EHR data, their primary function has been to analyze differences in severity of illness, outcomes, and treatment costs among participating centers. Disease specific trial registries have been formulated for acute kidney injury [4], acute respiratory distress syndrome [5] and septic shock [6]. Additionally, databases such as the Dartmouth Atlas utilize Medicare claims data to track discrepancies in costs and patient outcomes across the United States [7]. While these coordinated databases contain a large number of patients, they often have a narrow scope (i.e. for severity of illness, cost, or disease specific outcomes) and lack other significant clinical data that is required to answer a wide range of research questions, thus obscuring many likely confounding variables.

For example, the APACHE Outcomes database was created by merging APACHE (Acute Physiology and Chronic Health Evaluation) [8] with Project IMPACT [9] and includes data from approximately 150,000 intensive care unit (ICU) stays since 2010 [1]. While the APACHE Outcomes database is large and has contributed significantly to the medical literature, it has incomplete physiologic and laboratory measurements, and does not include provider notes or waveform data. The Phillips eICU [10], a telemedicine intensive care support provider, contains a database of over 2 million ICU stays. While it includes provider documentation entered into the software, it lacks clinical notes and waveform data. Furthermore, databases with different primary objectives (i.e., costs, quality improvement, or research) focus on different variables and outcomes, so caution must be taken when interpreting analyses from these databases.

Since 2003, the Laboratory for Computational Physiology at the Massachusetts Institute of Technology partnered in a joint venture with Beth Israel Deaconess Medical Center and Philips Healthcare, with support from the National Institute of Biomedical Imaging and Bioinformatics (NIBIB), to develop and maintain the Medical Information Mart for Intensive Care (MIMIC) database [11]. MIMIC is a public-access database that contains comprehensive clinical data from over 60,000 inpatient ICU admissions at Beth Israel Deaconess Medical Center. The de-identified data are freely shared, and nearly 2000 investigators from 32 countries have utilized it to date. MIMIC contains physiologic and laboratory data, as well as waveform data, nurse verified numerical data, and clinician documentation. This high resolution, widely accessible, database has served to support research in critical care and assist in the development of novel decision support algorithms, and will be the prototype example for the majority of this textbook.

## 1.4 Pitfalls and Challenges

Clinicians and data scientists must apply the same level of academic rigor when analyzing research from clinical databases as they do with more traditional methods of clinical research. To ensure internal and external validity, researchers must determine whether the data are accurate, adjusted properly, analyzed correctly, and presented cogently [12]. With regard to quality improvement projects, which frequently utilize hospital databases, one must ensure that investigators are applying rigorous standards to the performance and reporting of their studies [13].

Despite the tremendous value that the EHR contains, many clinical investigators are hesitant to use it to its full capacity partly due to its sheer complexity and the inability to use traditional data processing methods with large datasets. As a solution to the increased complexity associated with this type of research, we suggest that investigators work in collaboration with multidisciplinary teams including data scientists, clinicians and biostatisticians. This may require a shift in financial and academic incentives so that individual research groups do not compete for funding or publication; the incentives should promote joint funding and authorship. This would allow investigators to focus on the fidelity of their work and be more willing to share their data for discovery, rather than withhold access to a dataset in an attempt to be “first” to a solution.

Some have argued that the use of large datasets may increase the frequency of so-called “p-hacking,” wherein investigators search for significant results, rather than seek answers to clinically relevant questions. While it appears that p-hacking is widespread, the mean effect size attributed to p-hacking does not generally undermine the scientific consequences from large studies and meta-analyses. The use of large datasets may, in fact, reduce the likelihood of p-hacking by ensuring that researchers have suitable power to answer questions with even small effect

sizes, making the need for selective interpretation and analysis of the data to obtain significant results unnecessary. If significant discoveries are made utilizing big databases, this work can be used as a foundation for more rigorous clinical trials to confirm these findings. In the future, once comprehensive databases become more accessible to researchers, it is hoped that these resources can be used as hypothesis generating and testing ground for questions that will ultimately undergo RCT. If there is not a strong signal observed in a large preliminary retrospective study, proceeding to a resource-intensive and time-consuming RCT may not be advisable.

## 1.5 Conclusion

With advances in data collection and technology, investigators have access to more patient data than at any time in history. Currently, much of these data are inaccessible and underused. The ability to harness the EHR would allow for continuous learning systems, wherein patient specific data are able to feed into a population-based database and provide real-time decision support for individual patients based on data from similar patients in similar scenarios. Clinicians and patients would be able to make better decisions with those resources in place and the results would feed back into the population database [14].

The vast amount of data available to clinicians and scientists poses daunting challenges as well as a tremendous opportunity. The National Academy of Medicine has called for clinicians and researchers to create systems that “foster continuous learning, as the lessons from research and each care experience are systematically captured, assessed and translated into reliable care” [2]. To capture, assess, and translate these data, we must harness the power of the EHR to create data repositories, while also providing clinicians as well as patients with data-driven decision support tools to better treat patients at the bedside.

**Open Access** This chapter is distributed under the terms of the Creative Commons Attribution-NonCommercial 4.0 International License (<http://creativecommons.org/licenses/by-nc/4.0/>), which permits any noncommercial use, duplication, adaptation, distribution and reproduction in any medium or format, as long as you give appropriate credit to the original author(s) and the source, a link is provided to the Creative Commons license and any changes made are indicated.

The images or other third party material in this chapter are included in the work’s Creative Commons license, unless indicated otherwise in the credit line; if such material is not included in the work’s Creative Commons license and the respective action is not permitted by statutory regulation, users will need to obtain permission from the license holder to duplicate, adapt or reproduce the material.

## References

1. Celi LA, Mark RG, Stone DJ, Montgomery RA (2013) “Big data” in the intensive care unit. Closing the data loop. *Am J Respir Crit Care Med* 187:1157–1160
2. Smith M, Saunders R, Stuckhardt L, McGinnis JM (2013) Best care at lower cost: the path to continuously learning health care in America. National Academies Press
3. Mills EJ, Thorlund K, Ioannidis JP (2013) Demystifying trial networks and network meta-analysis. *BMJ* 346:f2914
4. Mehta RL, Kellum JA, Shah SV, Molitoris BA, Ronco C, Warnock DG, Levin A, Acute Kidney Injury N (2007) Acute Kidney Injury Network: report of an initiative to improve outcomes in acute kidney injury. *Crit Care* 11:R31
5. The Acute Respiratory Distress Syndrome Network (2000) Ventilation with lower tidal volumes as compared with traditional tidal volumes for acute lung injury and the acute respiratory distress syndrome. *N Engl J Med* 342:1301–1308
6. Dellinger RP, Levy MM, Rhodes A, Annane D, Gerlach H, Opal SM, Sevransky JE, Sprung CL, Douglas IS, Jaeschke R, Osborn TM, Nunnally ME, Townsend SR, Reinhart K, Kleinpell RM, Angus DC, Deutschman CS, Machado FR, Rubenfeld GD, Webb SA, Beale RJ, Vincent JL, Moreno R, Surviving Sepsis Campaign Guidelines Committee including the Pediatric S (2013) Surviving sepsis campaign: international guidelines for management of severe sepsis and septic shock: 2012. *Crit Care Med* 41:580–637
7. The Dartmouth Atlas of Health Care. Lebanon, NH. The Trustees of Dartmouth College 2015. Accessed 10 July 2015. Available from <http://www.dartmouthatlas.org/>
8. Zimmerman JE, Kramer AA, McNair DS, Malila FM, Shaffer VL (2006) Intensive care unit length of stay: Benchmarking based on Acute Physiology and Chronic Health Evaluation (APACHE) IV. *Crit Care Med* 34:2517–2529
9. Cook SF, Visscher WA, Hobbs CL, Williams RL, Project ICIC (2002) Project IMPACT: results from a pilot validity study of a new observational database. *Crit Care Med* 30:2765–2770
10. eICU Program Solution. Koninklijke Philips Electronics N.V, Baltimore, MD (2012)
11. Saeed M, Villarroel M, Reisner AT, Clifford G, Lehman L-W, Moody G, Heldt T, Kyaw TH, Moody B, Mark RG (2011) Multiparameter Intelligent Monitoring in Intensive Care II (MIMIC-II): a public-access intensive care unit database. *Crit Care Med* 39:952
12. Meurer S (2008) Data quality in healthcare comparative databases. MIT Information Quality Industry symposium
13. Davidoff F, Batalden P, Stevens D, Ogrinc G, Mooney SE, group Sd (2009) Publication guidelines for quality improvement studies in health care: evolution of the SQUIRE project. *BMJ* 338:a3152
14. Celi LA, Zimolzak AJ, Stone DJ (2014) Dynamic clinical data mining: search engine-based decision support. *JMIR Med Informatics* 2:e13

# Chapter 2

## Review of Clinical Databases

Jeff Marshall, Abdullah Chahin and Barret Rush

### Take Home Messages

- There are several open access health datasets that promote effective retrospective comparative effectiveness research.
- These datasets hold a varying amount of data with representative variables that are conducive to specific types of research and populations. Understanding these characteristics of the particular dataset will be crucial in appropriately drawing research conclusions.

### 2.1 Introduction

Since the appearance of the first EHR in the 1960s, patient driven data accumulated for decades with no clear structure to make it meaningful and usable. With time, institutions began to establish databases that archived and organized data into central repositories. Hospitals were able to combine data from large ancillary services, including pharmacies, laboratories, and radiology studies, with various clinical care components (such as nursing plans, medication administration records, and physician orders). Here we present the reader with several large databases that are publicly available or readily accessible with little difficulty. As the frontier of healthcare research utilizing large datasets moves ahead, it is likely that other sources of data will become accessible in an open source environment.

### 2.2 Background

Initially, EHRs were designed for archiving and organizing patients' records. They then became coopted for billing and quality improvement purposes. With time, EHR driven databases became more comprehensive, dynamic, and interconnected.

However, the medical industry has lagged behind other industries in the utilization of big data. Research using these large datasets has been drastically hindered by the poor quality of the gathered data and poorly organised datasets. Contemporary medical data evolved to more than medical records allowing the opportunity for them to be analyzed in greater detail. Traditionally, medical research has relied on disease registries or chronic disease management systems (CDMS). These repositories are a priori collections of data, often specific to one disease. They are unable to translate data or conclusions to other diseases and frequently contain data on a cohort of patients in one geographic area, thereby limiting their generalizability.

In contrast to disease registries, EHR data usually contain a significantly larger number of variables enabling high resolution of data, ideal for studying complex clinical interactions and decisions. This new wealth of knowledge integrates several datasets that are now fully computerized and accessible. Unfortunately, the vast majority of large healthcare databases collected around the world restrict access to data. Some possible explanations for these restrictions include privacy concerns, aspirations to monetize the data, as well as a reluctance to have outside researchers direct access to information pertaining to the quality of care delivered at a specific institution. Increasingly, there has been a push to make these repositories freely open and accessible to researchers.

### **2.3 The Medical Information Mart for Intensive Care (MIMIC) Database**

The MIMIC database (<http://mimic.physionet.org>) was established in October 2003 as a Bioengineering Research Partnership between MIT, Philips Medical Systems, and Beth Israel Deaconess Medical Center. The project is funded by the National Institute of Biomedical Imaging and Bioengineering [1].

This database was derived from medical and surgical patients admitted to all Intensive Care Units (ICU) at Beth Israel Deaconess Medical Center (BIDMC), an academic, urban tertiary-care hospital. The third major release of the database, MIMIC-III, currently contains more than 40 thousand patients with thousands of variables. The database is de-identified, annotated and is made openly accessible to the research community. In addition to patient information driven from the hospital, the MIMIC-III database contains detailed physiological and clinical data [2]. In addition to big data research in critical care, this project aims to develop and evaluate advanced ICU patient monitoring and decision support systems that will improve the efficiency, accuracy, and timeliness of clinical decision-making in critical care.

Through data mining, such a database allows for extensive epidemiological studies that link patient data to clinical practice and outcomes. The extremely high granularity of the data allows for complicated analysis of complex clinical problems.

### 2.3.1 Included Variables

There are essentially two basic types of data in the MIMIC-III database; clinical data driven from the EHR such as patients’ demographics, diagnoses, laboratory values, imaging reports, vital signs, etc (Fig. 2.1). This data is stored in a relational database of approximately 50 tables. The second primary type of data is the bedside monitor waveforms with associated parameters and events stored in flat binary files (with ASCII header descriptors). This unique library includes high-resolution data driven from tracings recorded from patients’ electroencephalograms (EEGs), electrocardiograms (EKGs or ECGs), and real-time, second to second tracings of vital signs of patients in the intensive care unit. IRB determined the requirement for individual patient consent was waived, as all public data were de-identified.

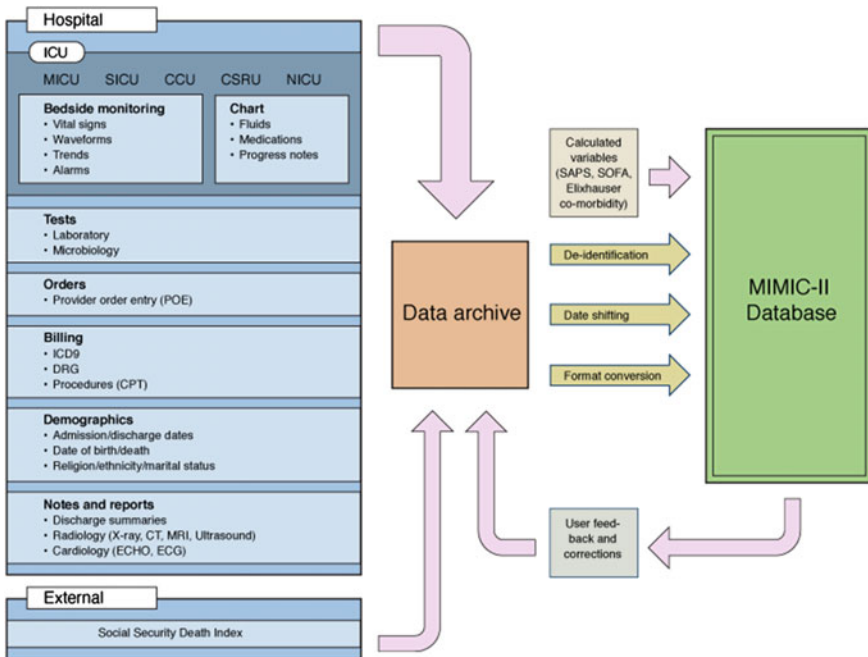


Fig. 2.1 Basic overview of the MIMIC database

### **2.3.2 Access and Interface**

MIMIC-III is an open access database available to any researchers around the globe who are appropriately trained to handle sensitive patient information. The database is maintained by PhysioNet (<http://physionet.org>), a diverse group of computer scientists, physicists, mathematicians, biomedical researchers, clinicians, and educators around the world. The third release was published in 2015 and is anticipated to continually be updated with additional patients as time progresses.

## **2.4 PCORnet**

PCORnet, the National Patient-Centered Clinical Research Network, is an initiative of the Patient-Centered Outcomes Research Institute (PCORI). PCORI involves patients as well as those who care for them in a substantive way in the governance of the network and in determining what questions will be studied. This PCORnet initiative was started in 2013, hoping to integrate data from multiple Clinical Data Research Networks (CDRNs) and Patient-Powered Research Networks (PPRNs) [3]. Its coordinating center bonds 9 partners: Harvard Pilgrim Health Care Institute, Duke Clinical Research Institute, AcademyHealth, Brookings Institution, Center for Medical Technology Policy, Center for Democracy & Technology, Group Health Research Institute, Johns Hopkins Berman Institute of Bioethics, and America's Health Insurance Plans. PCORnet includes 29 individual networks that together will enable access to large amounts of clinical and healthcare data. The goal of PCORnet is to improve the capacity to conduct comparative effectiveness research efficiently.

### **2.4.1 Included Variables**

The variables in PCORnet database are driven from the various EHRs used in the nine centers forming this network. It captures clinical data and health information that are created every day during routine patient visits. In addition, PCORnet is using data shared by individuals through personal health records or community networks with other patients as they manage their conditions in their daily lives. This initiative will facilitate research on various medical conditions, engage a wide range of patients from all types of healthcare settings and systems, and provide an excellent opportunity to conduct multicenter studies.



### **2.4.2 Access and Interface**

PCORnet is envisioned as a national research resource that will enable teams of health researchers and patients to work together on questions of shared interest. These teams will be able to submit research queries and receive to data conduct studies. Current PCORnet participants (CDRNs, PPRNs and PCORI) are developing the governance structures during the 18-month building and expansion phase [4].

## **2.5 Open NHS**

The National Health Services (NHS England) is an executive non-departmental public body of the Department of Health, a governmental entity. The NHS retains one of the largest repositories of data on people's health in the world. It is also one of only a handful of health systems able to offer a full account of health across care sectors and throughout lives for an entire population.

Open NHS is one branch that was established in October of 2011. The NHS in England has actively moved to open the vast repositories of information used across its many agencies and departments. The main objective of the switch to an open access dataset was to increase transparency and trace the outcomes and efficiency of the British healthcare sector [5]. High quality information is hoped to empower the health and social care sector in identifying priorities to meet the needs of local populations. The NHS hopes that by allowing patients, clinicians, and commissioners to compare the quality and delivery of care in different regions of the country using the data, they can more effectively and promptly identify where the delivery of care is less than ideal.

### **2.5.1 Included Variables**

Open NHS is an open source database that contains publicly released information, often from the government or other public bodies.

### **2.5.2 Access and Interface**

Prior to the creation of Open NHS platform, SUS (Secondary Uses Service) was set up as part of the National Programme for IT in the NHS to provide data for planning, commissioning, management, research and auditing. Open NHS has now replaced SUS as a platform for accessing the national database in the UK.

The National Institute of Health Research (NIHR) Clinical Research Network (CRN) has produced and implemented an online tool known as the Open Data Platform.

In addition to the retrospective research that is routinely conducted using such databases, another form of research is already under way to compare the data quality derived from electronic records with that collected by research nurses. Clinical Research Network staff can access the Open Data Platform and determine the number of patients recruited into research studies in a given hospital as well as the research being done at that hospital. They then determine which hospitals are most successful at recruiting patients, the speed with which they recruit, and in what specialty fields.

## 2.6 Other Ongoing Research

The following are other datasets that are still under development or have more restrictive access limitations:

### 2.6.1 *eICU—Philips*

As part of its collaboration with MIT, Philips will be granting access to data from hundreds of thousands of patients that have been collected and anonymized through the Philips Hospital to Home eICU telehealth program. The data will be available to researchers via PhysioNet, similar to the MIMIC database.

### 2.6.2 *VistA*

The **Veterans Health Information Systems and Technology Architecture (VistA)** is an enterprise-wide information system built around the Electronic Health Record (EHR), used throughout the United States Department of Veterans Affairs (VA) medical system. The VA health care system operates over 125 hospitals, 800 ambulatory clinics and 135 nursing homes. All of these healthcare facilities utilize the VistA interface that has been in place since 1997. The VistA system amalgamates hospital, ambulatory, pharmacy and ancillary services for over 8 million US veterans. While the health network has inherent research limitations and biases due to its large percentage of male patients, the staggering volume of high fidelity records available outweighs this limitation. The VA database has been used by numerous medical researchers in the past 25 years to conduct landmark research in many areas [6, 7].

The VA database has a long history of involvement with medical research and collaboration with investigators who are part of the VA system. Traditionally the

dataset access has been limited to those who hold VA appointments. However, with the recent trend towards open access of large databases, there are ongoing discussions to make the database available to more researchers. The vast repository of information contained in the database would allow a wide range of researchers to improve clinical care in many domains. Strengths of the data include the ability to track patients across the United States as well as from the inpatient to outpatient settings. As all prescription drugs are covered by the VA system, the linking of this data enables large pharmacoepidemiological studies to be done with relative ease.

### 2.6.3 *NSQUIP*

The National Surgical Quality Improvement Project is an international effort spearheaded by the American College of Surgeons (ACS) with a goal of improving the delivery of surgical care worldwide [8]. The ACS works with institutions to implement widespread interventions to improve the quality of surgical delivery in the hospital. A by-product of the system is the gathering of large amounts of data relating to surgical procedures, outcomes and adverse events. All information is gathered from the EHR at the specific member institutions.

The NSQUIP database is freely available to members of affiliated institutions, of which there are over 653 participating centers in the world. This database contains large amounts of information regarding surgical procedures, complications, and baseline demographic and hospital information. While it does not contain the granularity of the MIMIC dataset, it contains data from many hospitals across the world and thus is more generalizable to real-world surgical practice. It is a particularly powerful database for surgical care delivery and quality of care, specifically with regard to details surrounding complications and adverse events from surgery.

**Open Access** This chapter is distributed under the terms of the Creative Commons Attribution-NonCommercial 4.0 International License (<http://creativecommons.org/licenses/by-nc/4.0/>), which permits any noncommercial use, duplication, adaptation, distribution and reproduction in any medium or format, as long as you give appropriate credit to the original author(s) and the source, a link is provided to the Creative Commons license and any changes made are indicated.

The images or other third party material in this chapter are included in the work's Creative Commons license, unless indicated otherwise in the credit line; if such material is not included in the work's Creative Commons license and the respective action is not permitted by statutory regulation, users will need to obtain permission from the license holder to duplicate, adapt or reproduce the material.

## References

1. Lee J, Scott DJ, Villarroel M, Clifford GD, Saeed M, Mark RG (2011) Open-access MIMIC-II database for intensive care research. In: Annual international conference of the IEEE engineering in medicine and biology society, pp 8315–8318
2. Scott DJ, Lee J, Silva I et al (2013) Accessing the public MIMIC-II intensive care relational database for clinical research. *BMC Med Inform Decis Mak* 13:9
3. Fleurence RL, Curtis LH, Califf RM, Platt R, Selby JV, Brown JS (2014) Launching PCORnet, a national patient-centered clinical research network. *J Am Med Inform Assoc JAMIA* 21(4):578–582
4. Califf RM (2014) The patient-centered outcomes research network: a national infrastructure for comparative effectiveness research. *N C Med J* 75(3):204–210
5. Open data at the NHS [Internet]. Available from: <http://www.england.nhs.uk/ourwork/tsd/data-info/open-data/>
6. Maynard C, Chapko MK (2004) Data resources in the department of veterans affairs. *Diab Care* 27(Suppl 2):B22–B26
7. Smith BM, Evans CT, Ullrich P et al (2010) Using VA data for research in persons with spinal cord injuries and disorders: lessons from SCI QUERI. *J Rehabil Res Dev* 47(8):679–688
8. NSQUIP at the American College of Surgeons [Internet]. Available from: <https://www.facs.org/quality-programs/acs-nsqip>

# Chapter 3

## Challenges and Opportunities in Secondary Analyses of Electronic Health Record Data

Sunil Nair, Douglas Hsu and Leo Anthony Celi

### Take Home Messages

- Electronic health records (EHR) are increasingly useful for conducting secondary observational studies with power that rivals randomized controlled trials.
- Secondary analysis of EHR data can inform large-scale health systems choices (e.g., pharmacovigilance) or point-of-care clinical decisions (e.g., medication selection).
- Clinicians, researchers and data scientists will need to navigate numerous challenges facing big data analytics—including systems interoperability, data sharing, and data security—in order to utilize the full potential of EHR and big data-based studies.

### 3.1 Introduction

The increased adoption of EHR has created novel opportunities for researchers, including clinicians and data scientists, to access large, enriched patient databases. With these data, investigators are in a position to approach research with statistical power previously unheard of. In this chapter, we present and discuss challenges in the secondary use of EHR data, as well as explore the unique opportunities provided by these data.

### 3.2 Challenges in Secondary Analysis of Electronic Health Records Data

Tremendous strides have been made in making pooled health records available to data scientists and clinicians for health research activities, yet still more must be done to harness the full capacity of big data in health care. In all health related

fields, the data-holders—i.e., pharmaceutical firms, medical device companies, health systems, and now burgeoning electronic health record vendors—are simultaneously facing pressures to protect their intellectual capital and proprietary platforms, ensure data security, and adhere to privacy guidelines, without hindering research which depends on access to these same databases. Big data success stories are becoming more common, as highlighted below, but the challenges are no less daunting than they were in the past, and perhaps have become even more demanding as the field of data analytics in healthcare takes off.

Data scientists and their clinician partners have to contend with a research culture that is highly competitive—both within academic circles, and among clinical and industrial partners. While little is written about the nature of data secrecy within academic circles, it is a reality that tightening budgets and greater concerns about data security have pushed researchers to use such data as they have on-hand, rather than seek integration of separate databases. Sharing data in a safe and scalable manner is extremely difficult and costly or impossible even within the same institution. With access to more pertinent data restricted or impeded, statistical power and the ability for longitudinal analysis are reduced or lost. None of this is to say researchers have hostile intentions—in fact, many would appreciate the opportunity for greater collaboration in their projects. However, the time, funding, and infrastructure for these efforts are simply deficient. Data is also often segregated into various locales and not consistently stored in similar formats across clinical or research databases. For example, most clinical data is kept in a variety of unstructured formats, making it difficult to query directly via digital algorithms [1]. Within many hospitals, emergency department or outpatient clinical data may exist separately from the hospital and the Intensive Care Unit (ICU) electronic health records, so that access to one does not guarantee access to the other. Images from Radiology and Pathology are typically stored separately in yet other different systems and therefore are not easily linked to outcomes data. The Medical Information Mart for Intensive Care (MIMIC) database described later in this chapter, which contains ICU EHR data from the Beth Israel Deaconess Medical Center (BIDMC), addresses and resolves these artificial divisions, but requires extensive engineering and support staff not afforded to all institutions.

After years of concern about data secrecy, the pharmaceutical industry has recently turned a corner, making detailed trial data available to researchers outside their organizations. GlaxoSmithKline was among the first in 2012 [2], followed by a larger initiative—the Clinical Trial Data Request—to which other large pharmaceutical firms have signed-on [3]. Researchers can apply for access to large-scale information, and integrate datasets for meta-analysis and other systematic reviews. The next frontier will be the release of medical records held at the health system level. The 2009 Health Information Technology for Economic and Clinical Health (HITECH) Act was a boon to the HIT sector [4], but standards for interoperability between record systems continue to lag [5]. The gap has begun to be resolved by government sponsored health information exchanges, as well as the creation of novel research networks [6, 7], but most experts, data scientists, and working clinicians continue to struggle with incomplete data.

Many of the commercial and technical roadblocks alluded to above have their roots in the privacy concerns held by vendors, providers and their patients. Such concerns are not without merit—data breaches of large health systems are becoming distressingly common [8]. Employees of Partners Healthcare in Boston were recently targeted in a “phishing” scheme, unwittingly providing personal information that allowed hackers unauthorized access to patient information [9]; patients of Seton Healthcare in Texas suffered a similar breach just a few months prior [10]. Data breaches aren’t limited to healthcare providers—80 million Anthem enrollees may have suffered loss of their personal information to a cyberattack, the largest of its kind to-date [11]. Not surprisingly in the context of these breaches, healthcare companies have some of the lowest scores of all industries in email security and privacy practices [12]. Such reports highlight the need for prudence amidst exuberance when utilizing pooled electronic health records for big data analytics—such use comes with an ethical responsibility to protect population- and personal-level data from criminal activity and other nefarious ends. For this purpose, federal agencies have convened working groups and public hearings to address gaps in health information security, such as the de-identification of data outside HIPAA-covered entities, and consensus guidelines on what constitutes “harm” from a data breach [13].

Even when issues of data access, integrity, interoperability, security and privacy have been successfully addressed, substantial infrastructure and human capital costs will remain. Though the marginal cost of each additional big data query is small, the upfront cost to host a data center and employ dedicated data scientists can be significant. No figures exist for the creation of a healthcare big data center, and these figures would be variable anyway, depending on the scale and type of data. However, it should not be surprising that commonly cited examples of pooled EHRs with overlaid analytic capabilities—MIMIC (BIDMC), STRIDE (Stanford), the MemorialCare data mart (Memorial Health System, California, \$2.2 Billion annual revenue), and the High Value Healthcare Collaborative (hosted by Dartmouth, with 16 other members and funding from the Center for Medicare and Medicaid Services) [14]—come from large, high revenue healthcare systems with regional big-data expertise.

In addition to the above issues, the reliability of studies published using big data methods is of significant concern to experts and physicians. The specific issue is whether these studies are simply amplifications of low-level signals that do not have clinical importance, or are generalizable beyond the database from which they are derived. These are genuine concerns in a medical and academic atmosphere already saturated with innumerable studies of variable quality. Skeptics are concerned that big data analytics will only, “add to the noise,” diverting attention and resources from other venues of scientific inquiry, such as the traditional randomized controlled clinical trial (RCT). While the limitations of RCTs, and the favorable comparison of large observational study results to RCT findings are discussed below, these sentiments nevertheless have merit and must be taken seriously as

secondary analysis of EHR data continues to grow. Thought leaders have suggested expounding on the big data principles described above to create open, collaborative learning environments, whereby de-identified data can be shared between researchers—in this manner, data sets can be pooled for greater power, or similar inquiries run on different data sets to see if similar conclusions are reached [15]. The costs for such transparency could be borne by a single institution—much of the cost of creating MIMIC has already been invested, for instance, so the incremental cost of making the data open to other researchers is minimal—or housed within a dedicated collaborative—such as the High Value Healthcare Collaborative funded by its members [16] or PCORnet, funded by the federal government [7]. These collaborative ventures would have transparent governance structures and standards for data access, permitting study validation and continuous peer review of published and unpublished works [15], and mitigating the effects of selection bias and confounding in any single study [17].

As pooled electronic health records achieve even greater scale, data scientists, researchers and other interested parties expect that the costs of hosting, sorting, formatting and analyzing these records are spread among a greater number of stakeholders, reducing the costs of pooled EHR analysis for all involved. New standards for data sharing may have to come into effect for institutions to be truly comfortable with records-sharing, but within institutions and existing research collaboratives, safe practices for data security can be implemented, and greater collaboration encouraged through standardization of data entry and storage. Clear lines of accountability for data access should be drawn, and stores of data made commonly accessible to clarify the extent of information available to any institutional researcher or research group. The era of big data has arrived in healthcare, and only through continuous adaptation and improvement can its full potential be achieved.

### **3.3 Opportunities in Secondary Analysis of Electronic Health Records Data**

The rising adoption of electronic health records in the U.S. health system has created vast opportunities for clinician scientists, informaticians and other health researchers to conduct queries on large databases of amalgamated clinical information to answer questions both large and small. With troves of data to explore, physicians and scientists are in a position to evaluate questions of clinical efficacy and cost-effectiveness—matters of prime concern in 21st century American health care—with a qualitative and statistical power rarely before realized in medical research. The commercial APACHE Outcomes database, for instance, contains physiologic and laboratory measurements from over 1 million patient records across 105 ICUs since 2010 [18]. The Beth Israel Deaconess Medical Center—a tertiary



care hospital with 649 licensed beds including 77 critical care beds—provides an open-access single-center database (MIMIC) encompassing data from over 60,000 ICU stays [19].

Single- and multi-center databases such as those above permit large-scale inquiries without the sometimes untenable expense and difficulty of a randomized clinical trial (RCT), thus answering questions previously untestable in RCTs or prospective cohort studies. This can also be done with increased precision in the evaluation of diagnostics or therapeutics for select sub-populations, and for the detection of adverse events from medications or other interventions with greater expediency, among other advantages [20]. In this chapter, we offer further insight into the utility of secondary analysis of EHR data to investigate relevant clinical questions and provide useful decision support to physicians, allied health providers and patients.

### 3.4 Secondary EHR Analyses as Alternatives to Randomized Controlled Clinical Trials

The relative limitations of RCTs to inform real-world clinical decision-making include the following: many treatment comparisons of interest to clinicians have not been addressed by RCTs; when RCTs have been performed and appraised, half of systemic reviews of RCTs report insufficient evidence to support a given medical intervention; and, there are realistic cost and project limitations that prevent RCTs from exploring specific clinical scenarios. The latter include rare conditions, clinically uncommon or disparate events, and a growing list of combinations of recognized patient sub-groups, concurrent conditions (genetic, chronic, acute and healthcare-acquired), and diagnostic and treatment options [20, 21].

Queries on EHR databases to address clinical questions are essentially large, nonrandomized observational studies. Compared to RCTs, they are relatively more efficient and less expensive to perform [22], the majority of the costs having been absorbed by initial system installation and maintenance, and the remainder consisting primarily of research personnel salaries, server or cloud space costs. There is literature to suggest a high degree of correlation between treatment effects reported in nonrandomized studies and randomized clinical trials. Ioannidis et al. [23] found significant correlation (Spearman coefficient of 0.75,  $p < 0.001$ ) between the treatment effects reported in randomized trials versus nonrandomized studies across 45 diverse topics in general internal medicine, ranging from anticoagulation in myocardial infarction to low-level laser therapy for osteoarthritis. Of particular interest, significant variability in reported treatment outcome “was seen as frequently among the randomized trials as between the randomized and nonrandomized studies,” and they observed that variability was common among *both* randomized trials and nonrandomized studies [23]. It is worth pointing out that larger treatment effects were more frequently reported in nonrandomized studies than randomized trials (exact  $p = 0.009$ ) [23]; however, this need not be evidence

of publication bias, as relative study size and conservative trial protocol could also cause this finding. Ioannidis et al.'s [24] results are echoed by a more recent Cochrane meta-analysis, which found no significant difference in effect estimates between RCTs and observational studies regardless of the observational study design or heterogeneity.

To further reduce confounding in observational studies, researchers have employed propensity scoring [25], which allows balancing of numerous covariates between treatment groups as well as stratification of samples by propensity score for more nuanced analysis [26]. Kitsios and colleagues matched 18 unique propensity score studies in the ICU setting with at least one RCT evaluating the same clinical question and found a high degree of agreement between their estimates of relative risk and effect size. There was substantial difference in the magnitude of effect sizes in a third of comparisons, reaching statistical significance in one case [27]. Though the RCT remains atop the hierarchy of evidence-based medicine, it is hard to ignore the power of large observational studies that include adequate adjusting for covariates, such as carefully performed studies derived from review of EHRs. The scope of pooled EHR data—whether sixty thousand or one million records—affords insight into small treatment effects that may be under-reported or even missed in underpowered RCTs. Because costs are small compared to RCTs, it is also possible to investigate questions where realistically no study-sponsor will be found. Finally, in the case of databased observational studies, it becomes much more feasible to improve and repeat, or simply repeat, studies as deemed necessary to investigate accuracy, heterogeneity of effects, and new clinical insights.

### **3.5 Demonstrating the Power of Secondary EHR Analysis: Examples in Pharmacovigilance and Clinical Care**

The safety of pharmaceuticals is of high concern to both patients and clinicians. However, methods for ensuring detection of adverse events post-release are less robust than might be desirable. Pharmaceuticals are often prescribed to a large, diverse patient population that may have not been adequately represented in pre-release clinical trials. In fact, RCT cohorts may deliberately be relatively homogeneous in order to capture the intended effect(s) of a medication without “noise” from co-morbidities that could modulate treatment effects [28]. Humphreys and colleagues (2013) reported that in highly-cited clinical trials, 40 % of identified patients with the condition under consideration were not enrolled, mainly due to restrictive eligibility criteria [29]. Variation in trial design (comparators, endpoints, duration of follow-up) as well as trial size limit their ability to detect low-frequency or long-term side-effects and adverse events [28]. Post-market surveillance reports are imperfectly collected, are not regularly amalgamated, and may not be publically accessible to support clinical-decision making by physicians or inform decision-making by patients.

Queries on pooled EHRs—essentially performing secondary observational studies on large study populations—could compensate for these gaps in pharmacovigilance. Single-center approaches for this and similar questions regarding medication safety in clinical environments are promising. For instance, the highly publicized findings of the Kaiser Study on Vioxx<sup>®</sup> substantiated prior suspicions of an association between celecoxib and increased risk of serious coronary heart disease [30]. These results were made public in April 2004 after presentation at an international conference; Vioxx<sup>®</sup> was subsequently voluntarily recalled from the market in September of the same year. Graham and colleagues were able to draw on 2,302,029 person-years of follow-up from the Kaiser Permanente database, to find 8143 cases of coronary heart disease across all NSAIDs under consideration, and subsequently drill-down to the appropriate odds ratios [31].

Using the MIMIC database mentioned above, researchers at the Beth Israel Deaconess Medical Center were able to describe for the first time an increased mortality risk for ICU patients who had been on selective serotonin reuptake inhibitors prior to admission [32]. A more granular analysis revealed that mortality varied by specific SSRI, with higher mortality among patients taking higher-affinity SSRIs (i.e., those with greater serotonin inhibition); on the other hand, mortality could not be explained by common SSRI adverse effects, such as impact on hemodynamic variables [32].

The utility of secondary analysis of EHR data is not limited to the discovery of treatment effects. Lacking published studies to guide their decision to potentially anticoagulate a pediatric lupus patient with multiple risk factors for thrombosis, physicians at Stanford turned to their own EHR-querying platform (the Stanford Translational Research Integrated Database Environment—STRIDE) to create an electronic cohort of pediatric lupus patients to study complications from this illness [33]. In four hours' time, a single clinician determined that patients with similar lupus complications had a high relative risk of thrombosis, and the decision was made to administer anticoagulation [33].

### **3.6 A New Paradigm for Supporting Evidence-Based Practice and Ethical Considerations**

Institutional experiences such as those above, combined with evidence supporting the efficacy of observational trials to adequately inform clinical practice, validate the concept of pooled EHRs as large study populations possessing copious amounts of information waiting to be tapped for clinical decision support and patient safety. One can imagine a future clinician requesting a large or small query such as those described above. Such queries might relate to the efficacy of an intervention across a subpopulation, or for a single complicated patient whose circumstances are not satisfactorily captured in any published trial. Perhaps this is sufficient for the clinician to recommend a new clinical practice; or maybe they will design a

pragmatic observational study for more nuance—evaluating dose-responsiveness, or adverse effect profiles across subpopulations. As clinical decisions are made and the patient’s course of care shaped, this intervention and outcomes information is entered into the electronic health record, effectively creating a feedback loop for future inquiries [34].

Of course, the advantages of secondary analysis of electronic health records must always be balanced with ethical considerations. Unlike traditional RCTs, there is no explicit consent process for the use of demographic, clinical and other potentially sensitive data captured in the EHR. Sufficiently specific queries could yield very narrow results—theoretically specific enough to re-identify an individual patient. For instance, an inquiry on patients with a rare disease, within a certain age bracket, and admitted within a limited timeframe, could include someone who may be known to the wider community. Such an extreme example highlights the need for compliance with federal privacy laws as well as ensuring high institutional standards of data security such as secured servers, limited access, firewalls from the internet, and other data safety methods.

Going further, data scientists should consider additional measures intentionally designed to protect patient anonymity, e.g. date shifting as implemented in the MIMIC database (see Sect. 5.1, Chap. 5). In situations where queries might potentially re-identify patients, such as in the investigation of rare diseases, or in the course of a contagious outbreak, researchers and institutional research boards should seek accommodation with this relatively small subset of potentially affected patients and their advocacy groups, to ensure their comfort with secondary analyses. Disclosure of research intent and methods by those seeking data access might be required, and a patient option to embargo one’s own data should be offered.

It is incumbent on researchers and data scientists to explain the benefits of participation in a secondary analysis to patients and patient groups. Such sharing allows the medical system to create a clinical database of sufficient magnitude and quality to benefit individual- and groups of patients, in real-time or in the future. Also, passive clinical data collection allows the patient to contribute, at relatively very low risk and no personal cost, to the ongoing and future care of others. We believe that people are fundamentally sufficiently altruistic to consider contributions their data to research, provided the potential risks of data usage are small and well-described.

Ultimately, secondary analysis of EHR will only succeed if patients, regulators, and other interested parties are assured and reassured that their health data will be kept safe, and processes for its use are made transparent to ensure beneficence for all.

**Open Access** This chapter is distributed under the terms of the Creative Commons Attribution-NonCommercial 4.0 International License (<http://creativecommons.org/licenses/by-nc/4.0/>), which permits any noncommercial use, duplication, adaptation, distribution and reproduction in any medium or format, as long as you give appropriate credit to the original author(s) and the source, a link is provided to the Creative Commons license and any changes made are indicated.

The images or other third party material in this chapter are included in the work's Creative Commons license, unless indicated otherwise in the credit line; if such material is not included in the work's Creative Commons license and the respective action is not permitted by statutory regulation, users will need to obtain permission from the license holder to duplicate, adapt or reproduce the material.

## References

1. Riskin D (2012) Big data: opportunity and challenge. *HealthcareITNews*, 12 June 2012. URL: <http://www.healthcareitnews.com/news/big-data-opportunity-and-challenge>
2. Harrison C (2012) GlaxoSmithKline opens the door on clinical data sharing. *Nat Rev Drug Discov* 11(12):891–892. doi:10.1038/nrd3907 [Medline: 23197021]
3. Clinical Trial Data Request. URL: <https://clinicalstudydatarequest.com/>. Accessed 11 Aug 2015. [WebCite Cache ID 6TFyJeT7t]
4. Adler-Milstein J, Jha AK (2012) Sharing clinical data electronically: a critical challenge for fixing the health care system. *JAMA* 307(16):1695–1696
5. Verdon DR (2014) ONC's plan to solve the EHR interoperability puzzle: an exclusive interview with National Coordinator for Health IT Karen B. DeSalvo. *Med Econ*. URL: <http://medicaleconomics.modernmedicine.com/medical-economics/news/onc-s-plan-solve-ehr-interoperability-puzzle?page=full>
6. Green M (2015) 10 things to know about health information exchanges. *Becker's Health IT CIO Rev*. URL: <http://www.beckershospitalreview.com/healthcare-information-technology/10-things-to-know-about-health-information-exchanges.html>
7. PCORnet. URL: <http://www.pcornet.org/>. Accessed 11 Aug 2015
8. Dvorak K (2015) Big data's biggest healthcare challenge: making sense of it all. *FierceHealthIT*, 4 May 2015. URL: <http://www.fiercehealthit.com/story/big-datas-biggest-healthcare-challenge-making-sense-it-all/2015-05-04>
9. Bartlett J (2015) Partners healthcare reports data breach. *Boston Bus J*. URL: <http://www.bizjournals.com/boston/blog/health-care/2015/04/partners-healthcare-reports-potential-data-breach.html>
10. Dvorak K (2015) Phishing attack compromises info of 39 K at Seton healthcare family. *FierceHealthIT*, 28 April 2015. URL: <http://www.fiercehealthit.com/story/phishing-attack-compromises-info-39k-seton-healthcare-family/2015-04-28>
11. Bowman D (2015) Anthem hack compromises info for 80 million customers. *FierceHealthPayer*, 5 February 2015. URL: <http://www.fiercehealthpayer.com/story/anthem-hack-compromises-info-80-million-customers/2015-02-05>
12. Dvorak K (2015) Healthcare industry 'behind by a country mile' in email security. *FierceHealthIT*, 20 February 2015. URL: <http://www.fiercehealthit.com/story/healthcare-industry-behind-country-mile-email-security/2015-02-20>
13. White house seeks to leverage health big data, safeguard privacy. *HealthData Manage*. URL: <http://www.healthdatamanagement.com/news/White-House-Seeks-to-Leverage-Health-Big-Data-Safeguard-Privacy-50829-1.html>
14. How big data impacts healthcare. *Harv Bus Rev*. URL: [https://hbr.org/resources/pdfs/comm/sap/18826\\_HBR\\_SAP\\_Healthcare\\_Aug\\_2014.pdf](https://hbr.org/resources/pdfs/comm/sap/18826_HBR_SAP_Healthcare_Aug_2014.pdf). Accessed 11 Aug 2015
15. Moseley ET, Hsu DJ, Stone DJ, Celi LA (2014) Beyond open big data: addressing unreliable research. *J Med Internet Res* 16(11):e259

16. High value healthcare collaborative. URL: <http://highvaluehealthcare.org/>. Accessed 14 Aug 2015
17. Badawi O, Brennan T, Celi LA et al (2014) Making big data useful for health care: a summary of the inaugural mit critical data conference. *JMIR Med Inform* 2(2):e22
18. APACHE Outcomes. Available at: [https://www.cerner.com/Solutions/Hospitals\\_and\\_Health\\_Systems/Critical\\_Care/APACHE\\_Outcomes/](https://www.cerner.com/Solutions/Hospitals_and_Health_Systems/Critical_Care/APACHE_Outcomes/). Accessed Nov 2014
19. Saeed M, Villarroel M, Reisner AT et al (2011) Multiparameter intelligent monitoring in intensive care II (MIMIC-II): a public-access intensive care unit database. *Crit Care Med* 39:952
20. Ghassemi M, Celi LA, Stone DJ (2015) State of the art review: the data revolution in critical care. *Crit Care* 19:118
21. Mills EJ, Thorlund K, Ioannidis J (2013) Demystifying trial networks and network meta-analysis. *BMJ* 346:f2914
22. Angus DC (2007) Caring for the critically ill patient: challenges and opportunities. *JAMA* 298:456–458
23. Ioannidis JPA, Haidich A-B, Pappa M et al (2001) Comparison of evidence of treatment effects in randomized and nonrandomized studies. *JAMA* 286:7
24. Anglemyer A, Horvath HT, Bero L (2014) Healthcare outcomes assess with observational study designs compared with those assessed in randomized trials. *Cochrane Database Syst Rev* 29:4
25. Gayat E, Pirracchio R, Resche-Rigon M et al (2010) Propensity scores in intensive care and anaesthesiology literature: a systematic review. *Intensive Care Med* 36:1993–2003
26. Glynn RJ, Schneeweiss S, Stürmer T (2006) Indications for propensity scores and review of their use in pharmacoepidemiology. *Basic Clin Pharmacol Toxicol* 98:253–259
27. Kitsios GD, Dahabreh IJ, Callahan S et al (2015) Can we trust observational studies using propensity scores in the critical care literature? A systematic comparison with randomized clinical trials. *Crit Care Med* (Epub ahead of print)
28. Celi LA, Moseley E, Moses C et al (2014) from pharmacovigilance to clinical care optimization. *Big Data* 2(3):134–141
29. Humphreys K, Maisel NC, Blodgett JC et al (2013) Extent and reporting of patient nonenrollment in influential randomized clinical trials, 2001 to 2010. *JAMA Intern Med* 173:1029–1031
30. Vioxx and Drug Safety. Statement of Sandra Kweder M.D. (Deputy Director, Office of New Drugs, US FDA) before the Senate Committee on Finance. Available at: <http://www.fda.gov/NewsEvents/Testimony/ucm113235.htm>. Accessed July 2015
31. Graham DJ, Campen D, Hui R et al (2005) Risk of acute myocardial infarction and sudden cardiac death in patients treated with cyclo-oxygenase 2 selective and non-selective non-steroidal anti-inflammatory drugs: nested case-control study. *Lancet* 365(9458):475–481
32. Ghassemi M, Marshall J, Singh N et al (2014) Leveraging a critical care database: selective serotonin reuptake inhibition use prior to ICU admission is associated with increased hospital mortality. *Chest* 145(4):1–8
33. Frankovich J, Longhurst CA, Sutherland SM (2011) Evidence-based medicine in the EMR era. *New Engl J Med* 365:19
34. Celi LA, Zimolzak AJ, Stone DJ (2014) Dynamic clinical data mining: search engine-based decision support. *JMIR Med Inform* 2(1):e13

# Chapter 4

## Pulling It All Together: Envisioning a Data-Driven, Ideal Care System

David Stone, Justin Rousseau and Yuan Lai

### Take Home Messages

- An Ideal Care System should incorporate fundamental elements of control engineering, such as effective and data-driven sensing, computation, actuation, and feedback.
- These systems must be carefully and intentionally designed to support clinical decision-making, rather than being allowed to evolve based on market pressures and user convenience.

This chapter presents ideas on how data could be systematically more effectively employed in a purposefully engineered healthcare system. We have previously written on potential components of such a system—e.g. dynamic clinical data mining, closing the loop on ICU data, optimizing the data system itself, crowd-sourcing, etc., and will attempt to ‘pull it all together’ in this chapter, which we hope will inspire and encourage others to think about and move to create such a system [1–10]. Such a system, in theory, would support clinical workflow by [1] leveraging data to provide both accurate personalized, or ‘precision,’ care for individuals while ensuring optimal care at a population level; [2] providing coordination and communication among the users of the system; and [3] defining, tracking, and enhancing safety and quality. While health care is intrinsically heterogeneous at the level of individual patients, encounters, specialties, and clinical settings, we also propose some general systems-based solutions derived from contextually defined use cases. This chapter describes the fundamental infrastructure of an Ideal Care System (ICS) achieved through identifying, organizing, capturing, analyzing, utilizing and appropriately sharing the data.

## 4.1 Use Case Examples Based on Unavoidable Medical Heterogeneity

The intrinsic heterogeneities inherent in health care at the level of individual patients, encounters, specialties, and clinical settings has rendered the possibility of a single simple systems solution impossible. We anticipate requirements in an ICS

**Table 4.1** Clinical use cases with pertinent clinical and data objectives

Clinical use case	Clinical objective(s)	Data objectives
Outpatient in state of good health	Provide necessary preventive care; address mild intermittent acute illnesses	Health maintenance documentation: vaccination records, cancer screening records, documentation of allergies; data on smoking and obesity
Outpatient with complex chronic medical problems	Connect and coordinate care among diverse systems and caregivers	Ensure accurate and synchronized information across care domains without need for oversight by patient and/or family; targeted monitors to prevent admission, readmission
Inpatient—elective surgery	Provide a safe operative and perioperative process	Track processes relevant to safety and quality; track outcomes, complication rates, including safety related outcomes
Inpatient (emergency department, inpatient wards, intensive care units)	Identify and predict ED patients who require ICU care; ICU safety and quality; Identify and predict adverse events	Track outcomes of ED patients including ICU transfers and mortality; Track adverse events; Track usual and innovative ICU metrics
Nursing home patient	Connect and coordinate care among diverse locations and caregivers for a patient who may not be able to actively participate in the process	Ensure accurate and synchronized information across care domains without need for oversight by patient and/or family
Recent discharge from hospital	Prevent re-admission	Data mining for predictors associated with re-admission and consequent interventions based on these determinations; Track functional and clinical outcomes
Labor and delivery	Decision and timing for caesarian section; Lower rates of intervention and complications	Data mining for predictors associated with c-section or other interventions; track complication rates and outcomes
Palliative care/end of life	Decision and timing for palliative care; Ensure comfort and integrity	Data mining to determine characteristics that indicate implementation of palliative care

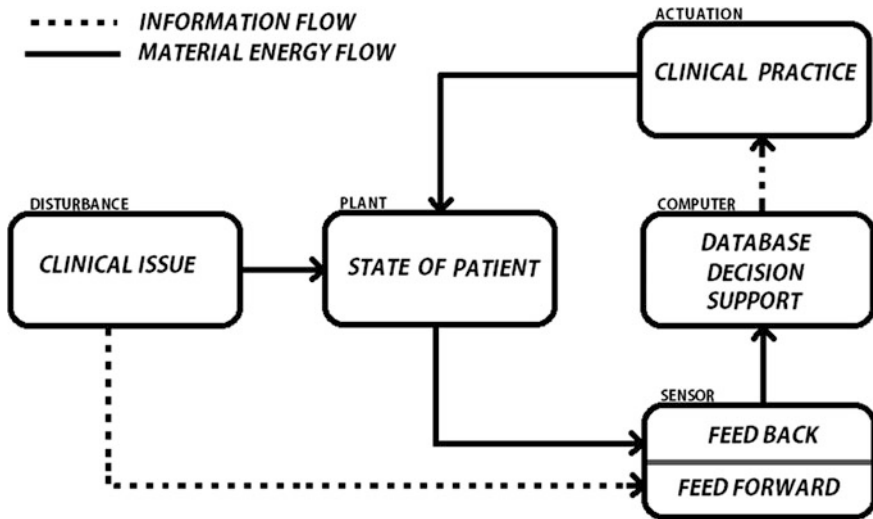


of identifying common core elements that apply to the medical care of all patients (e.g. safety principles, preventive care, effective end of life care, accurate and up-to-date problem list and medication list management), and subsequently formulating pathways based on specific context. One should note that an individual patient can cross over multiple categories. Any complex outpatient will also have the baseline requirements of meeting objectives of an outpatient in good health and may at some point have an inpatient encounter. Table 4.1 identifies a variety of use cases including abbreviated forms of the pertinent clinical and data issues associated with them.

## 4.2 Clinical Workflow, Documentation, and Decisions

The digitalization of medicine has been proceeding with the wide adoption of electronic health records, thanks in part to meaningful use as part of the Health Information Technology for Economic and Clinical Health (HITECH) Act [11], but has received varying responses by clinicians. An extensive degree of digitalization is a fundamental element for creating an ICS. Defined at the highest level, a system is a collection of parts and functions (a.k.a. components and protocols) that accepts inputs and produces outputs [3]. In healthcare, the inputs are the patients in various states of health and disease, and the outputs are the outcomes of these patients. Figure 4.1 provides a simple control loop describing the configuration of a data driven health system.

The practice of medicine has a long history of being data driven, with diagnostic medicine dating back to ancient times [12]. Doctors collect and assemble data from histories, physical exams, and a large variety of tests to formulate diagnoses, prognoses, and subsequent treatments. However, this process has not been optimal in the sense that these decisions, and the subsequent actuations based on these decisions, have been made in relative isolation. The decisions depend on the prior experience and current knowledge state of the involved clinician(s), which may or may not be based appropriately on supporting evidence. In addition, these decisions have, for the most part, not been tracked and measured to determine their impact on safety and quality. We have thereby lost much of what has been done that was good and failed to detect much of what was bad [1]. The digitization of medicine provides an opportunity to remedy these issues. In spite of the suboptimal usability of traditional paper documentation, the entries in physicians' notes in natural language constitute the core data required to fuel an ideal care system. While data items such as lab values and raw physiological vital signs may be reasonably reliable and quantitative, they generally do not represent the decision-making and the diagnoses that are established or being considered, which are derived from the analysis and



**Fig. 4.1 Control loop depicting a data-driven care system.** A clinical issue such as an infection or vascular occlusion affects the state of the patient. Subsequently, the system sensor detects this change and submits the relevant data to the computer for storage and analysis. This may or may not result in actuation of a clinical practice intervention that further affects the state of the patient, which feeds back into the system for further analysis. Feed-forward control involves the transmission of disturbances directly to the sensor without first affecting the state of the patient. The detection of a risk factor for venous thromboembolism that triggers prophylaxis in a protocol-based manner represents a clinical example of feed-forward control [3]

synthesis of the available data (the assessment with differential diagnosis) as well as the data to be acquired in the diagnostic workup (the plan).

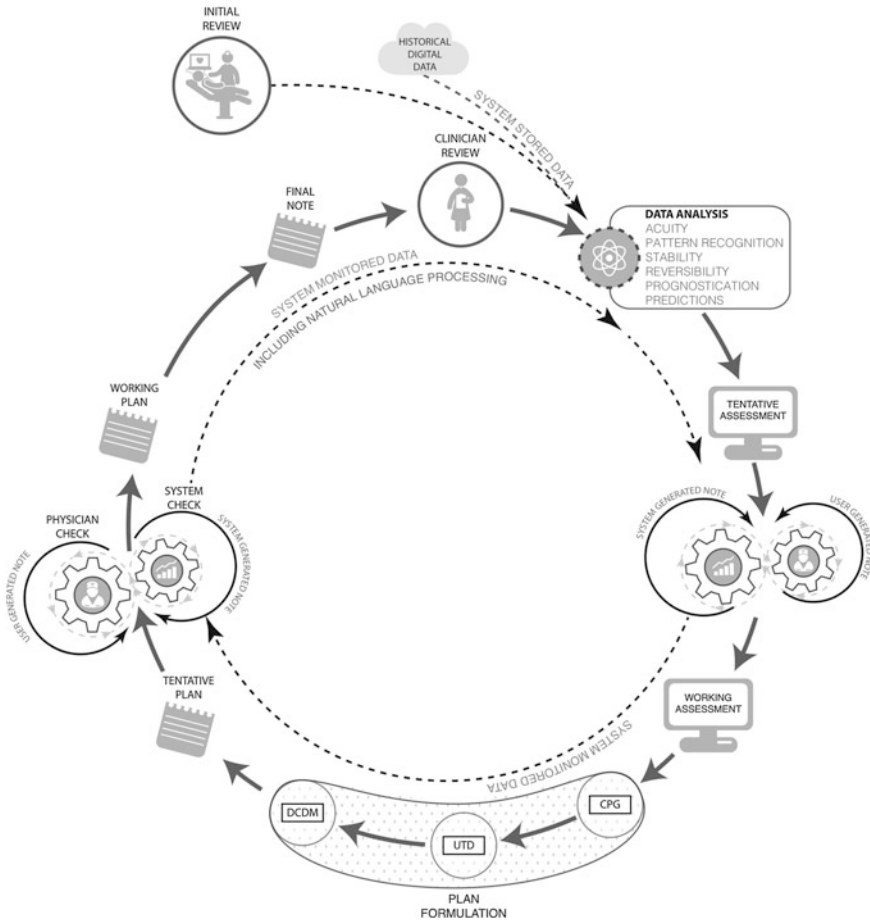
The digitalization of medicine has encountered two key issues: [1] How does one develop a digitally based workflow that supports rapid, accurate documentation so that the clinician feels enlightened rather than burdened by the process? [2] How can the documentation process of data entry support and enhance the medical decision-making process? The first iteration of electronic health records (EHRs) has simply attempted to replicate the traditional paper documentation in a digital format. In order to address the first issue, smarter support of the documentation process will require innovative redesigns to improve the EHR as it evolves. Rather than requiring the clinician to sit at a keyboard facing away from a patient, the process needs to capture real-time input from the patient encounter in such potential modes as voice and visual recognition. This must be done so that the important details are captured without unduly interfering with personal interactions or without erroneous entries due to delayed recall. The receiving system must ‘consider’ the patient’s prior information in interpreting new inputs in order to accurately recognize and

assimilate the essential information from the current encounter. Furthermore, the data that is collected should not be functionally lost as the patient advances through time and moves between geographic locales. A critical issue is one that has been perpetuated in the current practice of medicine from one encounter to another—the physician and patient should not need to ‘reinvent the informational wheel’ with every encounter. While each physician should provide a fresh approach to the patient, this should not require refreshing the patient’s entire medical story with each single encounter, wasting time and effort. Furthermore, what is documented should be transparent to the patient in contrast to the physician beneficence model that has been practiced for most of the history of medicine where it was considered beneficial to restrict patients’ access to their own records. Steps are being taken toward this goal of transparency with the patient with the OpenNotes movement that began in 2010. The effects of this movement are being recognized nationally with significant potential benefits in many areas relating to patient safety and quality of care [13].

Regarding the second issue, we have written of how quality data entry can support medical decision-making [14]. Future iterations of an innovatively redesigned EHR in an ideal care system should assist in the smart assembly and presentation of the data as well as presentation of decision support in the form of evidence and education. The decision-maker is then able to approach each encounter with the advantage of prior knowledge and supporting evidence longitudinally for the individual patient as well as comparisons of their states of health with patients with similar data and diagnoses (Fig. 4.2). Patterns and trends in the data can be recognized, particularly in the context of that patient’s prior medical history and evolving current state (Fig. 4.3).

Population data should be leveraged to optimize decisions for individuals, with information from individual encounters captured, stored and utilized to support the care of others as we have described as ‘dynamic clinical data mining [2].’ This also is similar to what has been described as a ‘learning healthcare system’ or by a ‘green button’ for consulting such population data for decision support [15, 16].

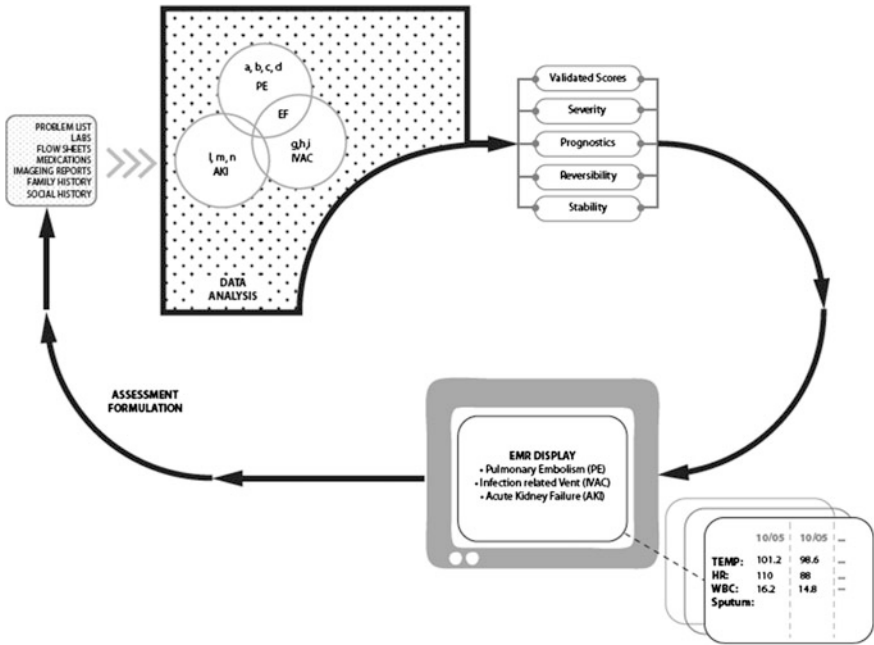
In summary, an ICS must have tools (e.g. enhanced versions of current EHRs) to capture and utilize the data in ways that make documentation and decision-making effective and efficient rather than isolated and burdensome. While we realize that individual clinicians function brilliantly in spite of the technical and systems-level obstacles and inefficiencies with which they are faced, we have reached a point of necessity, one recognized by the Institute of Medicine threatening the quality and safety of healthcare, requiring the development of digital tools that facilitate necessary data input and decisions as well as tools that can interact with and incorporate other features of an integrated digitally-based ICS [17]. This will require close interactions and collaborations among health care workers, engineers including software and hardware experts, as well as patients, regulators, policy-makers, vendors and hospital business and technical administrators [5].



**Fig. 4.2 Clinician documentation with fully integrated data systems support.** Prior notes and data are input for future notes and decisions. The digital system analyzes input and displays suggested diagnoses and problem list, and then diagnostic test and treatment recommendations hierarchically based on various levels of evidence: CPG—clinical practice guidelines, UTD—Up to Date®, DCDM—Dynamic clinical data mining [14]

### 4.3 Levels of Precision and Personalization

Many of the tools available to clinicians have become fantastically sophisticated, including technical devices and molecular biological and biochemical knowledge. However, other elements, including those used intensively on a daily basis, are more primitive and would be familiar to clinicians of the distant past. These elements include clinical data such as the heart rates and blood pressures recorded in a



**Fig. 4.3 Mock screenshot for the Assessment screen with examples of background data analytics.** Based on these analytics that are constantly being performed by the system and are updated as the user begins to enter a note, a series of problems are identified and suggested to the user by EMR display. After consideration of these suggestions in addition to their own analysis, the user can select or edit the problems that are suggested or input entirely new problems. The final selection of problems is considered with ongoing analytics for future assessments [14]

nursing flowsheet. Patient monitoring is not generally employed on a data driven basis, particularly decisions regarding who gets monitored with what particular signals, the duration of monitoring, and whether the data are stored, analyzed, and utilized beyond the current time. Furthermore, it is questionable whether the precedent of setting common numeric thresholds for abnormally high or low values extracts maximal clinical information from those signals. This recognition of abnormal values has become a significant problem of excessive false alarms and alarm fatigue [18]. Data analysis should provide clinicians with personalized and contextualized characterizations of individual vital signs (e.g. heart and respiratory rate variability patterns, subtle ECG waveform shapes, etc.) so that truly important changes can be recognized quickly and effectively while not overwhelming the cognitive load of the clinician. This would constitute ‘personalized data driven monitoring’ in which the raw data on the monitor screen is analyzed in real time to provide more information regarding the state of the patient. This will become more important and pressing as monitoring becomes more ubiquitous both in the hospital

and in outpatient settings, which is not far from a reality with the exponential development of mobile health monitors and applications. A potential approach to this issue would be to treat monitors as specialized component of the EHR rather than standalone devices that display the heart rate and beep frequently, at times even when there is no good reason. In fact, this has occurred to some functional extent as monitors have become networked and in many cases can import data into the EHR. The loop will be closed when information flows bi-directionally so that the EHR (and other elements such as infusion pumps) can assist in providing clinical contexts and personalized information to enhance the performance potential of the monitors [14]. Whereas the user interface of the monitor is currently solely one of adjusting the monitored channels and the alarm settings, the user interface will also be increasingly rich so that the user could, for instance with the proper credentials, access, edit and annotate the EHR from a bedside or central monitor, or add information directly to the monitor to calibrate the monitoring process.

The data from monitors is beginning to be used for prospective analytic purposes in terms of predicting neonatal sepsis and post cardiac surgery problems [19, 20]. The HeRO neonatal alert focuses on diminution in heart rate variability and increase in decelerations to identify potential sepsis, whereas the Etiometry alert employs a sophisticated statistical analysis of those monitored elements reflecting cardiac function to detect and define problems earlier than humans could ordinarily do. The HeRO team is now working to develop predictive analytics for respiratory deterioration, significant hemorrhage, and sepsis in adults [21]. The essential point is that monitors employing such predictive analytics, as well as streaming and retrospective analytics, can leverage large amounts of personal data to improve the monitoring process as well as the healthcare encounter experience, particularly in areas of quality and safety. However, it is essential that such individual applications, exponentially growing in complexity and sophistication, not be introduced as unrelated bits into an already data-overburdened and under-engineered health care system. In the current state of the healthcare system, there is already plenty of data. However, it is not being systematically handled, utilized and leveraged. It is essential that such new applications be embedded thoughtfully into workflows. They must also be systematically interfaced and interoperable with the core care system, represented by the next generation of EHRs, so that the information can be used in a coordinated fashion, audited in terms of its impact on workflows, and tracked in terms of its impact on patient outcomes, quality, and safety. The addition of further system elements should be planned, monitored, and evaluated in a data-driven fashion. New elements should contribute to the system that uses data in a targeted, well-managed fashion rather than simply collecting it. The introduction of elements outside the core EHR requires communication and coordination among all system elements, just as effectively using the EHR alone requires communication and coordination among caregivers and patients.

## 4.4 Coordination, Communication, and Guidance Through the Clinical Labyrinth

Coordination and communication would be fundamental properties of an ICS contrasted with the enormous individual efforts required to achieve these goals in the current state. Patients and caregivers should be able to assume that the system captures, stores, and shares their information where and when it is needed. When the patient leaves her nursing home to be seen in a local emergency room or by her neurologist, the clinicians should have all previously available information necessary to treat her. This should also be the case when she returns to the nursing home with the system updating her record with events from her previous encounter as well as implementing new orders reflecting that encounter. This seamless communication and coordination is especially important for the kinds of patients who cannot provide this support themselves: people who are elderly, cognitively impaired, acutely ill, etc. Unfortunately, the current system was developed as a tool to aid in billing and reimbursement of interventions and the challenge that we face with transforming and continuing to develop it into an ICS is to transition its focus to patient care. Currently, patients and their advocates must battle with unrelenting challenges of opacity and obstruction facing immense frustration and threats to patient safety and quality of care where such risks would not be tolerated in any other industry.

Data and the efficient transmission of information where and when it is needed are at the core of an ICS. Information networks that permeate all the relevant locales must be created employing all the interoperability, privacy, and security features necessary. The system must maintain its focus on the patient and must instantly (or sufficiently quickly to meet clinical needs) update, synchronize, and transmit the information to all those who need to know, including qualified and permitted family members and the patients themselves relevant to the care of the patient. Many clinicians may be misinterpreted as being unresponsive, or even uncaring, in response to their continuing frustration with the difficulty of obtaining timely and accurate information. The current state of siloed healthcare systems makes obtaining information from other locales prohibitively challenging with no particular reward for continuing to struggle to obtain pertinent information for the continued care of patients, evoking reactions from caregivers including rudeness, neglect, hostility, or burnout. This challenge to obtain information from outside sources also leads to repeat diagnostic testing exposing patients to unnecessary risks and exposures such as is seen when a patient is transferred from one institution to another but the imaging obtained at the first institution is not able to be transferred appropriately [22]. Unfortunately, the Health Insurance Portability and Accountability Act of 1996 (HIPAA), the very legislation designed to enable the portability of information relevant to patient care, has further hindered this transmission of information. An efficient system of communication and coordination would benefit the caregiver experience in addition to the patients by providing them with the tools and information that they need to carry out their jobs.

The scope of those affected by the challenges inherent in the current healthcare system is broad. Not only does it affect those that are cognitively impaired, but also those with limited education or resources. It affects those that have complicated medical histories as well as those without previous histories. Even when patients are capable of contributing to the management of their own clinical data, there is potential to be overwhelmed and incapacitated through the complexities of the system when affected by illness, no matter the acuity, severity, or complexity. Interoperable EHRs focused on patients rather than locations or brands would provide the necessary and updated information as a patient moves from office A to hospital system B to home and back to emergency room C. When people are sick, they and their caregivers should be supported by the system rather than forced to battle it.

The sharing of data among patients and caregivers in a safe and efficient manner is not primarily a technical problem at this time, although there are many technical challenges to achieving such seamless interoperability. It is also a business as well as a political problem. This complex interaction can be seen in efforts toward healthcare architecture and standards supporting interoperability described in the JASON report, “A Robust Health Data Infrastructure” with responses from industry and EHR vendors in the development and adoption of HL7 Fast Healthcare Interoperability Resources (FHIR) standards [23, 24]. In an ICS, all parties must cooperate to interconnect EHRs among caregivers and locals so that the accurate and reliable data essential for healthcare can be coordinated, synchronized, and communicated across practice domains but within each patient’s domain. As we have seen on individual patient levels, an overabundance of data is not useful if it is not processed, analyzed, placed into the appropriate context, and available to the right people at the right places and times.

## 4.5 Safety and Quality in an ICS

There are many examples in healthcare, such as with bloodletting with leeches, where what was thought to be best practice, based on knowledge or evidence at the time, was later found to be harmful to patients. Our knowledge and its application must be in a continual state of assessment and re-assessment so that unreliable elements can be identified and action taken before, or at least minimal, harm is done [4]. There is currently no agreement on standard metrics for safety and quality in healthcare and we are not going to attempt to establish standard definitions in this chapter [25]. However, in order to discuss these issues, it is important to establish a common understanding of the terminologies and their meaning.

At a conceptual level, we conceive clinical **safety** as a strategic optimization problem in which the maximum level of permissible actuation must be considered and implemented in the simultaneous context of allowing the minimal degree of care-related harm. The objective is to design and implement a care system that minimizes safety risks to approach a goal of zero. The digitization of medicine



affords a realistic chance of attaining this goal in an efficient and effective manner. The application of systems engineering principles also provides tools to design these kinds of systems.

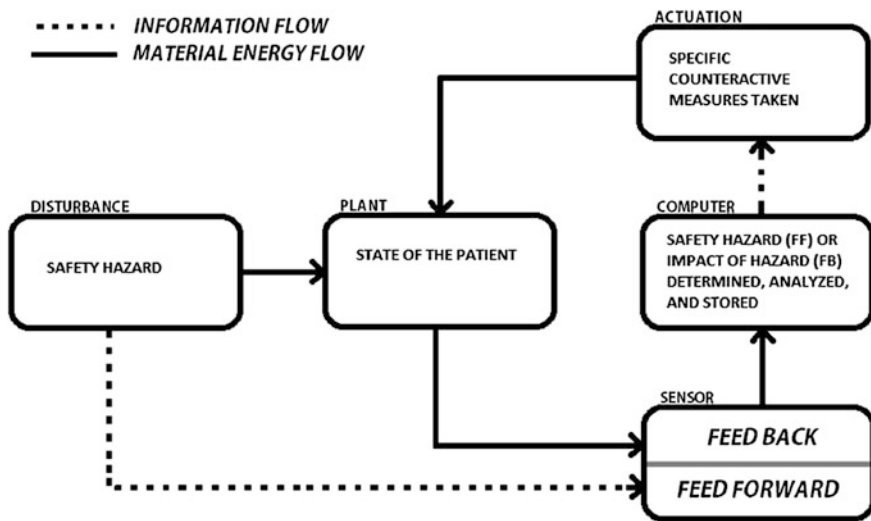
The overall **quality** of healthcare is a summation of the experience of individuals, and for these individuals, there may be varying degrees of quality for different periods of their experience. Similar to safety, we also think of quality as a strategic optimization problem in which outcomes and benefits are maximized or optimized, while the costs and risks involved in the processes required to achieve them, are minimized. The provision of quality via optimized outcomes in clinical care is, to a large extent, a problem in engineering information reliability and flow, providing the best evidence at the right times to assist in making the best decisions [3]. The concepts of the ‘best evidence’ and ‘best decisions’ themselves depend on input sources that range from randomized control trials to informed expert opinion to local best practices. To provide actual actuation, information flows must be supplemented by chemical (medications), mechanical (surgery, physical therapy, injections, human touch) and electromagnetic (imaging, ultrasound, radiation therapy, human speech) modalities, which can institute the processes indicated by those information flows.

Furthermore, quality may also be defined with respect to the degree of success in treatment of the disease state. Diseases addressed in modern medicine are, to a surprisingly large and increasingly recognized extent, those of control problems in bioengineering [10]. These diseases may stem from control problems affecting inflammation, metabolism, physiological homeostasis, or the genome. However, these all represent failure in an element or elements of a normally well-controlled biological system. The quality of the clinical response to these failures is best improved by understanding them sufficiently and thoroughly enough so that targeted and tolerable treatments can be developed that control and/or eliminate the systems dysfunction represented by clinical disease. This should be accomplished in a way that minimizes undue costs in physical, mental, or even spiritual suffering. Ultimately, medical quality is based primarily on outcomes, but the nature of the processes leading to those outcomes must be considered. Optimal outcomes are desirable, but not at any cost, in the broad definition of the term. For example, prolonging life indefinitely is not an optimal outcome in some circumstances that are contextually defined by individual, family, and cultural preferences.

Having defined safety and quality in our context, the next step is to develop systems that capture, track and manage these concepts in retrospective, real-time, and predictive manners. It is only when we know precisely what static and dynamic elements of safety and quality we wish to ensure that we can design the systems to support these endeavors. These systems will involve the integration of hardware and software systems such as physiologic monitors with the EHR (including Computerized Provider Order Entry, Picture Archiving and Communication System, etc.), and will require a variety of specialized, domain-specific data analytics as well as technical innovations such as wireless body sensor networks to capture patient status in real time. The system will connect and communicate pertinent information among caregivers by populating standardized, essential access

and alert nodes with timely and accurate information. It is also necessary that information flows bi-directionality (from the records of individuals to the population record, and from the population record to individuals) so that both can benefit from the data [2, 14]. Clearly, this will require an overall monitoring and information system that is interoperable, interactive both with its own components and its users, and actively but selectively informative. Future generations of clinicians will receive their education in an environment in which these systems are ubiquitous, selectively modifiable based on inputs such as crowdsourcing, and intrinsic to the tasks at hand, in contrast to the siloed and apparently arbitrarily imposed applications current clinicians may resist and resent [5, 8].

We noted the importance of control problems in disease, and control will also represent a fundamental component in the design of future safety and quality systems. The detection and prevention of adverse events is a significant challenge when depending on self-reporting methods or chart review and this issue is of high importance in the US [26, 27]. Predictive analytics can be developed as elements of the system to prospectively inform users of threats to safety and quality [19–21]. Carefully designed feed-forward components will inform participants in real time that an high risk activity is occurring so that it can be rectified without requiring retroactive analysis (Fig. 4.4—safety control loop below). Retrospective data analytics will track the factors affecting quality and safety so that practice,



**Fig. 4.4 Control loop depicting a data-driven safety system.** A clinical safety issue affects the state of the patient. Subsequently, the system sensor detects this change and submits the relevant data to the computer for storage and analysis. This may or may not result in actuation of a counteractive intervention that further affects the state of the patient, which feeds back into the system for further analysis. Feed-forward control involves the transmission of disturbances directly to the sensor without first affecting the state of the patient. An example of such a feed-forward control includes a faulty device or a biohazard

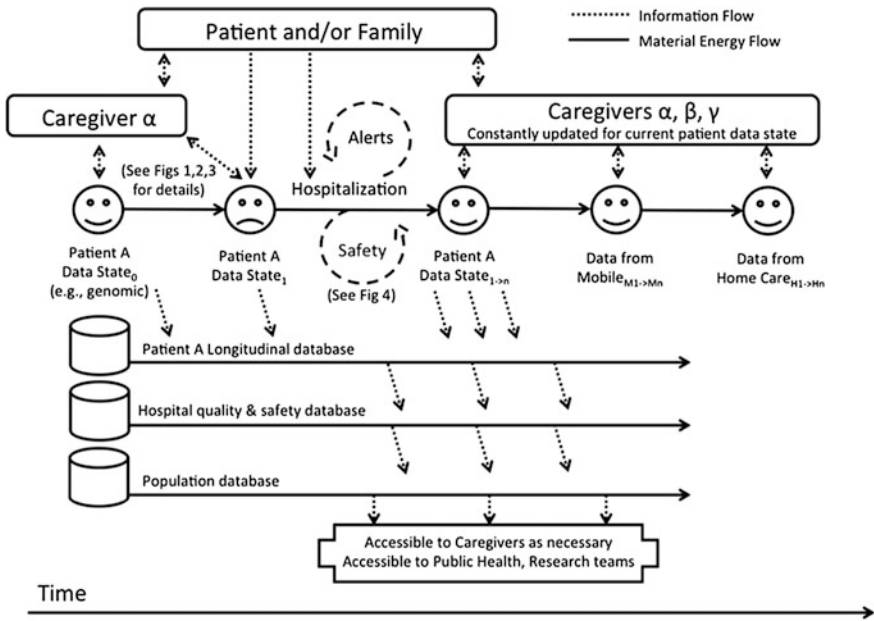
workflow, and technological systems can be accordingly modified. Such an ICS will be capable of monitoring medical errors, adverse events, regulatory and safety agency concerns and metrics, and compliance with best practice as well as meaningful use in parallel with costs and outcomes.

## 4.6 Conclusion

The basic systems solutions to the health care data problem rest on fully and inclusively addressing the axes of patient, care giver and care system considerations, which at times are apparently independent, but are ultimately interactive and interdependent. The required systems design will also greatly benefit from basic incorporation of the fundamental elements of control engineering such as effective and data-driven sensing, computation, actuation, and feedback. An Ideal Care System must be carefully and intentionally designed rather than allowed to evolve based on market pressures and user convenience.

The patient's data should be accurate, complete, and up-to-date. As patients progress in time, their records must be properly and timely updated with new data while concurrently, old data are modified and/or deleted as the latter become irrelevant or no longer accurate. New entry pipelines such as patient-generated and remotely generated data, as well as genomic data, must be taken into consideration and planned for. These data should be securely, reliably, and easily accessible to the designated appropriate users including the patient. The caregiver should have access to these data via a well-designed application that positively supports the clinical documentation process and includes reasonable and necessary decision support modalities reflecting best evidence, historical data of similar cases in the population, as well as the patient's own longitudinal data. All should have access to the data so far as it is utilized to construct the current and historical patterns of safety and quality. In addition to the data of individuals, access to the data of populations is required for the above purposes as well as to provide effective interventions in emergency situations such as epidemics. The creation of this kind of multimodal systems solution (Fig. 4.5—Ideal Care System Architecture below) will require the input of a great variety of experts including those from the EHR, monitoring devices, data storage, and data analytic industries along with leaders in healthcare legislation, policy makers, regulation, and administration.

Many important engineering, economic, and political questions remain that are not addressed in this chapter. What and who will provide the infrastructure and who will pay for it? Will this kind of system continue to work with current hardware and software or require fundamental upgrades to function at the required level of reliability and security? How and where will the controls be embedded in the system?



**Fig. 4.5 Information Architecture of an Ideal Care System.** This diagram integrates the concepts described in this chapter depicting data driven care systems, safety systems, along with connection and coordination of patient data across multiple modalities to achieve an Ideal Care System. Patients move through time and interact with the ICS in different contexts. Parallel databases are integrated with the patient data states in time including an individual patient’s longitudinal database, hospital quality and safety database, and a population database. Data from the patient, mobile technologies and from the home care entities keep caregivers informed of the most current patient data state

For example, will they be at the individual smart monitoring level or at a statewide public health level? How will the metadata obtained be handled for the good of individuals and populations? It is critical that the addition of new modalities and devices be fully integrated into the system rather than adding standalone components that may contribute more complexity and confusion than benefit. These goals will require cooperation previously unseen among real and potential competitors and those who have previously been able to work in relative isolation.

**Open Access** This chapter is distributed under the terms of the Creative Commons Attribution-NonCommercial 4.0 International License (<http://creativecommons.org/licenses/by-nc/4.0/>), which permits any noncommercial use, duplication, adaptation, distribution and reproduction in any medium or format, as long as you give appropriate credit to the original author(s) and the source, a link is provided to the Creative Commons license and any changes made are indicated.

The images or other third party material in this chapter are included in the work’s Creative Commons license, unless indicated otherwise in the credit line; if such material is not included in the work’s Creative Commons license and the respective action is not permitted by statutory regulation, users will need to obtain permission from the license holder to duplicate, adapt or reproduce the material.

## References

1. Celi LA, Mark RG, Stone DJ, Montgomery R (2013) "Big data" in the ICU: closing the data loop. *Am J Respir Crit Care Med* 187(11):1157–1160
2. Celi LA, Zimolzak AJ, Stone DJ (2014) Dynamic clinical data mining: search engine-based clinical decision support. *J Med Internet Res Med Inform* 2(1):e13. doi:[10.2196/medinform.3110](https://doi.org/10.2196/medinform.3110)
3. Celi LA, Csete M, Stone D (2014) Optimal data systems: the future of clinical predictions and decision support. *Curr Opin Crit Care* 20:573–580
4. Moseley ET, Hsu D, Stone DJ, Celi LA (2014) Beyond data liberation: addressing the problem of unreliable research. *J Med Internet Res* 16(11):e259
5. Celi LA, Ippolito A, Montgomery R, Moses C, Stone DJ (2014) Crowdsourcing knowledge discovery and innovations in medicine. *J Med Internet Res* 16(9):e216. doi:[10.2196/jmir.3761](https://doi.org/10.2196/jmir.3761)
6. Celi LA, Moseley E, Moses C, Ryan P, Somai M, Stone DJ, Tang K (2014) From pharmacovigilance to clinical care optimization. *Big Data* 2(3):134–141. doi:[10.1089/big.2014.0008](https://doi.org/10.1089/big.2014.0008)
7. Badawi O, Brennan T, Celi LA, Feng M, Ghassemi M, Ippolito A, Johnson A, Mark RG, Mayaud L, Moody G, Moses C, Naumann T, Pimentel M, Pollard TJ, Santos M, Stone DJ, Zimolzak AJ (2014) Making big data useful for health care: a summary of the inaugural MIT critical data conference. *J Med Internet Res Med Inform* 2(2):e22. doi:[10.2196/medinform.3447](https://doi.org/10.2196/medinform.3447)
8. Moskowitz A, McSparron J, Stone DJ, Celi LA (2015) Preparing a new generation of clinicians for the era of big data. *Harvard Med Student Rev* 2(1):24–27
9. Ghassemi M, Celi LA, Stone DJ (2015) The data revolution in critical care. *Ann Update Intensive Care Emerg Med* 2015(2015):573–586
10. Stone DJ, Csete ME, Celi LA (2015) Engineering control into medicine. *J Crit Care*. Published Online: January 29, 2015. doi:[10.1016/j.jcrc.2015.01.019](https://doi.org/10.1016/j.jcrc.2015.01.019)
11. Health Information Technology for Economic and Clinical Health (HITECH) Act, Title XIII of Division A and Title IV of Division B of the American Recovery and Reinvestment Act of 2009 (ARRA), Pub. L. No. 111-5, 123 Stat. 226 (Feb. 17, 2009), codified at 42 U.S.C. §§300jj et seq.; §§17901 et seq
12. Horstmanshoff HFJ, Stol M, Tilburg C (2004) Magic and rationality in ancient near Eastern and Graeco-Roman medicine, pp 97–99. Brill Publishers. ISBN 978-90-04-13666-3
13. Bell SK, Folcarelli PH, Anselmo MK, Crotty BH, Flier LA, Walker J (2014) Connecting Patients and Clinicians: The Anticipated Effects of Open Notes on Patient Safety and Quality of Care. *Jt Comm J Qual Patient Saf* 41(8):378–384(7)
14. Celi LA, Marshall JD, Lai Y, Stone DJ, Physician documentation and decision making in the digital era. *J Med Internet Res Med Inform* (Forthcoming)
15. Longhurst CA, Harrington RA, Shah NH (2014) A 'green button' for using aggregate patient data at the point of care. *Health Aff* 33(7):1229–1235
16. Friedman C, Rubin J, Brown J et al (2014) *J Am Med Inform Assoc* 0:1–6. doi:[10.1136/amiajnl-2014-002977](https://doi.org/10.1136/amiajnl-2014-002977)
17. Institute of Medicine (2012) Best care at lower cost: the path to continuously learning health care in America. Retrieved from: <http://iom.nationalacademies.org/Reports/2012/Best-Care-at-Lower-Cost-The-Path-to-Continuously-Learning-Health-Care-in-America.aspx>
18. The Joint Commission (2014) National Patient safety goal on alarm management 2013
19. [www.etiometry.com](http://www.etiometry.com)
20. [www.heroscore.com](http://www.heroscore.com)
21. Personal communication, Randall Moorman, MD
22. Sodickson A, Opraseuth J, Ledbetter S (2011) Outside imaging in emergency department transfer patients: CD import reduces rates of subsequent imaging utilization. *Radiology* 260(2):408–413

23. A Robust Health Data Infrastructure. (Prepared by JASON at the MITRE Corporation under Contract No. JSR-13-700). Agency for Healthcare Research and Quality, Rockville, MD. April 2014. AHRQ Publication No. 14-0041-EF
24. Health Level Seven® International. HL7 Launches Joint Argonaut Project to Advance FHIR. N.p., 4 Dec. 2014. Web. 31 Aug. 2015. [http://www.hl7.org/documentcenter/public\\_temp\\_32560CB2-1C23-BA17-0CBD5D492A8F70CD/pressreleases/HL7\\_PRESS\\_20141204.pdf](http://www.hl7.org/documentcenter/public_temp_32560CB2-1C23-BA17-0CBD5D492A8F70CD/pressreleases/HL7_PRESS_20141204.pdf)
25. Austin JM et al (2015) National hospital ratings systems share few common scores and may generate confusion instead of clarity. *Health Aff* 34(3):423–430. doi:10.1377/hlthaff.2014.0201
26. Elton GEBM, Ripsak GEH (2005) Automated detection of adverse events using natural language processing of discharge summaries. *J Am Med Inform Assoc* 12:448–458
27. Kohn LT, Corrigan JM, Donaldson MS (eds) (2000) *To err is human: building a safer health system*, vol 2. National Academy Press, Washington, DC

# Chapter 5

## The Story of MIMIC

Roger Mark

### Take Home Messages

- MIMIC is a Medical Information Mart for Intensive Care and consists of several comprehensive data streams in the intensive care environment, in high levels of richness and detail, supporting complex signal processing and clinical querying that could permit early detection of complex problems, provide useful guidance on therapeutic interventions, and ultimately lead to improved patient outcomes.
- This complicated effort required a committed and coordinated collaboration across academic, industry, and clinical institutions to provide a radically open access data platform accessible by researchers around the world.

### 5.1 The Vision

Patients in hospital intensive care units (ICUs) are physiologically fragile and unstable, generally have life-threatening conditions, and require close monitoring and rapid therapeutic interventions. They are connected to an array of equipment and monitors, and are carefully attended by the clinical staff. Staggering amounts of data are collected daily on each patient in an ICU: multi-channel waveform data sampled hundreds of times each second, vital sign time series updated each second or minute, alarms and alerts, lab results, imaging results, records of medication and fluid administration, staff notes and more. In early 2000, our group at the Laboratory of Computational Physiology at MIT recognized that the richness and detail of the collected data opened the feasibility of creating a new generation of monitoring systems to track the physiologic state of the patient, employing the power of modern signal processing, pattern recognition, computational modeling, and knowledge-based clinical reasoning. In the long term, we hoped to design

monitoring systems that not only synthesized and reported all relevant measurements to clinicians, but also formed pathophysiologic hypotheses that best explained the observed data. Such systems would permit early detection of complex problems, provide useful guidance on therapeutic interventions, and ultimately lead to improved patient outcomes.

It was also clear that although petabytes of data are captured daily during care delivery in the country's ICUs, most of these data were not being used to generate evidence or to discover new knowledge. The challenge, therefore, was to employ existing technology to collect, archive and organize finely detailed ICU data, resulting in a research resource of enormous potential to create new clinical knowledge, new decision support tools, and new ICU technology. We proposed to develop and make public a "substantial and representative" database gathered from complex medical and surgical ICU patients.

## 5.2 Data Acquisition

In 2003, with colleagues from academia (Massachusetts Institute of Technology), industry (Philips Medical Systems), and clinical medicine (Beth Israel Deaconess Medical Center, BIDMC) we received NIH (National Institutes of Health) funding to launch the project "Integrating Signals, Models and Reasoning in Critical Care", a major goal of which was to build a massive critical care research database. The study was approved by the Institutional Review Boards of BIDMC (Boston, MA) and MIT (Cambridge, MA). The requirement for individual patient consent was waived because the study would not impact clinical care and all protected health information was to be de-identified.

We set out to collect comprehensive clinical and physiologic data from all ICU patients admitted to the multiple adult medical and surgical ICUs of our hospital (BIDMC). Each patient record began at ICU admission and ended at final discharge from the hospital. The data acquisition process was continuous and invisible to staff. It did not impact the care of patients or methods of monitoring. Three categories of data were collected: *clinical data*, which were aggregated from ICU information systems and hospital archives; high-resolution *physiological data* (waveforms and time series of vital signs and alarms obtained from bedside monitors); and *death data* from Social Security Administration Death Master Files (See Fig. 5.1).

### 5.2.1 Clinical Data

Bedside clinical data were downloaded from archived data files of the CareVue Clinical Information System (Philips Healthcare, Andover, MA) used in the ICUs. Additional clinical data were obtained from the hospital's extensive digital archives. The data classes included:



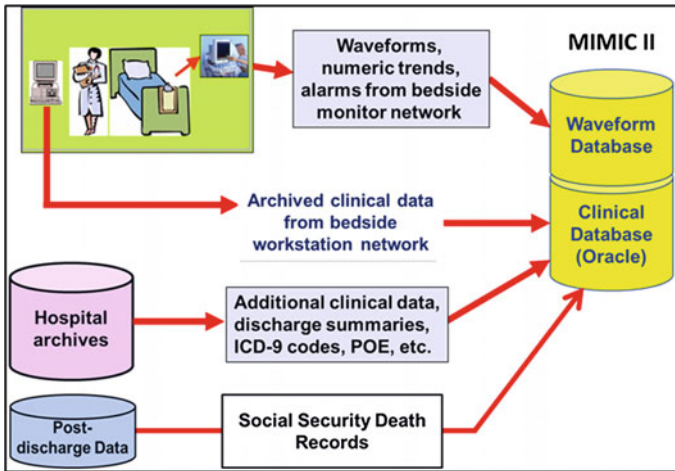


Fig. 5.1 MIMIC II data sources

- **Patient demographics**
- **Hospital administrative data:** admission/discharge/death dates, room tracking, billing codes, etc.
- **Physiologic:** hourly vital signs, clinical severity scores, ventilator settings, etc.
- **Medications:** IV medications, physician orders
- **Lab tests:** chemistry, hematology, ABGs, microbiology, etc.
- **Fluid balance data**
- **Notes and reports:** Discharge summaries; progress notes; ECG, imaging and echo reports.

### 5.2.2 Physiological Data

Physiological data were obtained with the technical assistance of the monitoring system vendor. Patient monitors were located at every ICU patient bed. Each monitor acquired and digitized multi-parameter physiological waveform data, processed the signals to derive time series (trends) of clinical measures such as heart rate, blood pressures, and oxygen saturation, etc., and also produced bedside monitor alarms. The waveforms (such as electrocardiogram, blood pressures, pulse plethysmograms, respirations) were sampled at 125 Hz, and trend data were updated each minute. The data were subsequently stored temporarily in a central database server that typically supported several ICUs. A customized archiving agent created and stored permanent copies of the physiological data. The data were physically transported from the hospital to the laboratory every 2–4 weeks where they were de-identified, converted to an open source data format, and incorporated into the MIMIC II waveform database. Unfortunately, limited capacity and

intermittent failures of the archiving agents limited waveform collection to a fraction of the monitored ICU beds.

### 5.2.3 *Death Data*

The Social Security Death Master files were used to document subsequent dates of death for patients who were discharged alive from the hospital. Such data are important for 28-day and 1-year mortality studies.

## 5.3 Data Merger and Organization

A major effort was required in order to organize the diverse collected data into a well-documented relational database containing integrated medical records for each patient. Across the hospital's clinical databases, patients are identified by their unique Medical Record Numbers and their Fiscal Numbers (the latter uniquely identifies a particular hospitalization for patients who might have been admitted multiple times), which allowed us to merge information from many different hospital sources. The data were finally organized into a comprehensive relational database. More information on database merger, in particular, how database integrity was ensured, is available at the MIMIC-II web site [1]. The database user guide is also online [2].

An additional task was to convert the patient waveform data from Philips' proprietary format into an open-source format. With assistance from the medical equipment vendor, the waveforms, trends, and alarms were translated into WFDB, an open data format that is used for publicly available databases on the National Institutes of Health-sponsored *PhysioNet* web site [3].

All data that were integrated into the MIMIC-II database were de-identified in compliance with Health Insurance Portability and Accountability Act standards to facilitate public access to MIMIC-II. Deletion of protected health information from structured data sources was straightforward (e.g., database fields that provide the patient name, date of birth, etc.). We also removed protected health information from the discharge summaries, diagnostic reports, and the approximately 700,000 free-text nursing and respiratory notes in MIMIC-II using an automated algorithm that has been shown to have superior performance in comparison to clinicians in detecting protected health information [4]. This algorithm accommodates the broad spectrum of writing styles in our data set, including personal variations in syntax, abbreviations, and spelling. We have posted the algorithm in open-source form as a general tool to be used by others for de-identification of free-text notes [5].

## 5.4 Data Sharing

MIMIC-II is an unprecedented and innovative open research resource that grants researchers from around the world free access to highly granular ICU data and in the process substantially accelerates knowledge creation in the field of critical care medicine. The MIMIC Waveform Database is freely available to all via the PhysioNet website, and no registration is required. The MIMIC Clinical Database is also available without cost. To restrict users to legitimate medical researchers, access to the clinical database requires completion of a simple data use agreement (DUA) and proof that the researcher has completed human subjects training [6].

The MIMIC-II clinical database is available in two forms. In the first form, interested researchers can obtain a flat-file text version of the clinical database and the associated database schema that enables them to reconstruct the database using a database management system of their choice. In the second form, interested researchers can gain limited access to the database through QueryBuilder, a password-protected web service. Database searches using QueryBuilder allow users to familiarize themselves with the database tables and to program database queries using the Structured Query Language. Query output, however, is limited to 1000 rows because of our laboratory's limited computational resources. Accessing and processing data from MIMIC-II is complex. It is recommended that studies based on the MIMIC-II clinical database be conducted as collaborative efforts that include clinical, statistical, and relational database expertise. Detailed documentation and procedures for obtaining access to MIMIC-II are available at the MIMIC-II web site [1]. The current release of MIMIC-II is version 2.6, containing approximately 36,000 patients, including approximately 7000 neonates, and covering the period 2001–2008. At the present time approximately 1700 individuals worldwide in academia, industry, and medicine have been credentialed to access MIMIC-II and are producing research results in physiologic signal processing, clinical decision support, predictive algorithms in critical care, pharmacovigilance, natural language processing, and more.

## 5.5 Updating

In 2008 the hospital made a major change in the ICU information system technology and in ICU documentation procedures. The Philips CareVue system was replaced with iMDsoft's MetaVision technology. In 2013 we began a major update to MIMIC to incorporate adult ICU data for the period 2008–2012. The effort required learning the entirely new data schema of MetaVision, and merging the new data format with the existing MIMIC design. The new MetaVision data included new data elements such as physician progress notes, oral and bolus medication administration records, etc. Updated data were extracted from hospital archives and from the SSA death files for the newly added patients. Almost two years of effort was invested to acquire, organize, debug, normalize and document the new database before releasing it.

MIMIC-III includes 20,000 new adult ICU admissions, bringing the total to approximately 60,000. The new database is known as MIMIC-III, and the acronym has been recast as “**Medical Information Mart for Intensive Care**” [7].

## 5.6 Support

Support of the MIMIC databases includes: credentialing new users, administration of the authorized user list (i.e. users who have signed the DUA and have been granted permission to access MIMIC-II), user account creation, password resets and granting/revoking permissions. The servers providing MIMIC-II include authentication, application, database and web servers. All systems must be monitored, maintained, upgraded and backed up; the maintenance burden continues to increase as the number of database users grows. The engineering staff at LCP attempt to answer user queries as needed. Common questions are added to list of frequently asked questions on the MIMIC website and we regularly update our online documentation.

## 5.7 Lessons Learned

Building and distributing MIMIC-like databases is challenging, complex, and requires the cooperation and support of a number of individuals and institutions. A list of some of the more important requirements follows (Table 5.1).

**Table 5.1** Health data requirements

- |   |
|---|
| 1. The availability of digitized ICU and hospital data including structured and unstructured clinical data and high resolution waveform and vital sign data           |
| 2. A cooperative and supportive hospital IT department to assist in data extraction   |
| 3. A supportive IRB and hospital administration to assure both protection of patient privacy and release of de-identified data to the research community              |
| 4. Adequate engineering and data science capability to design and implement the database schema and to de-identify the data (including the unstructured textual data) |
| 5. Sophisticated signal processing expertise to reformat and manage proprietary waveform data streams   |
| 6. Cooperation and technical support of equipment vendors   |
| 7. Adequate computational facilities for data archiving and distribution  |
| 8. Adequate technical and administrative personnel to provide user support and credentialing of users   |
| 9. Adequate financial support   |

## 5.8 Future Directions

The MIMIC-III database is a powerful and flexible research resource, but the generalizability of MIMIC-based studies is somewhat limited by the fact that the data are collected from a single institution. Multi-center data would have the advantages of including wider practice variability, and of course a larger number of cases. Data from international institutions would add still greater strength to the database owing to the even larger variations in practice and patient populations.

Our long-term goal is to create a public, multi-center, international data archive for critical care research. We envisage a massive, detailed, high-resolution ICU data archive containing complete medical records from patients around the world. The difficulty of such a project cannot be understated; nevertheless we propose to lay the foundation for such a system by developing a scalable framework that can readily incorporate data from multiple institutions, capable of supporting research on cohorts of critically ill patients from around the world.

**Acknowledgments** The development and maintenance of the MIMIC and PhysioNet resources have been funded by the National Institute of Biomedical Imaging and Bioengineering (NIBIB) and the National Institute of General Medical Sciences (NIGMS) over the period 2003 to present. Grants R01EB1659, R01EB017205, R01GM104987, and U01EB008577.

**Open Access** This chapter is distributed under the terms of the Creative Commons Attribution-NonCommercial 4.0 International License (<http://creativecommons.org/licenses/by-nc/4.0/>), which permits any noncommercial use, duplication, adaptation, distribution and reproduction in any medium or format, as long as you give appropriate credit to the original author(s) and the source, a link is provided to the Creative Commons license and any changes made are indicated.

The images or other third party material in this chapter are included in the work's Creative Commons license, unless indicated otherwise in the credit line; if such material is not included in the work's Creative Commons license and the respective action is not permitted by statutory regulation, users will need to obtain permission from the license holder to duplicate, adapt or reproduce the material.

## References

1. MIMIC-II Web Site. <http://physionet.org/mimic2>
2. MIMIC User Guide. <http://physionet.org/mimic2/UserGuide/>
3. WaveForm DataBase Data Format. <http://www.physionet.org/physiotools/wfdb.shtml>
4. Neamatullah I, Douglass M, Lehman LH, Reisner A, Villarreal M, Long WJ, Szolovits P, Moody GB, Mark RG, Clifford GD (2008) Automated de-identification of free-text medical records. *BMC Med Inform Decis Mak* 8:32. doi:10.1186/1472-6947-8-327
5. Deidentification Software. <http://www.physionet.org/physiotools/deid/>
6. Accessing MIMIC. [http://www.physionet.org/mimic2/mimic2\\_access.shtml](http://www.physionet.org/mimic2/mimic2_access.shtml)
7. MIMIC-III Website. <http://mimic.physionet.org/>

# Chapter 6

## Integrating Non-clinical Data with EHRs

Yuan Lai, Edward Moseley, Francisco Salgueiro and David Stone

### Take Home Messages

- Non-clinical factors make a significant contribution to an individual’s health and providing this data to clinicians could inform context, counseling, and treatments.
- Data stewardship will be essential to protect confidential health information while still yielding the benefits of an integrated health system.

### 6.1 Introduction

The definition of “clinical” data is expanding, as a datum becomes clinical once it has a relation to a disease process. For example: the accessibility of one’s home would classically be defined as non-clinical data, but in the context of a patient with a disability, this fact may become clinically relevant, and entered into the encounter note much like the patient’s blood pressure and body temperature. However, even with this simple example, we can envision some of the problems with traditional non-clinical data being re-classified as clinical data, particularly due to its complexity.

### 6.2 Non-clinical Factors and Determinants of Health

Non-clinical factors are already significantly linked to health. Many public health policies focusing on transportation, recreation, food systems and community development are based on the relation between health and non-clinical determinants

---

The original version of this chapter was revised: A chapter author’s name Edward Moseley was added. The erratum to this chapter is available at [10.1007/978-3-319-43742-2\\_30](https://doi.org/10.1007/978-3-319-43742-2_30)

such as behavioral, social and environmental factors [1]. Behavioral factors such as physical activity, diet, smoking and alcohol consumption are highly related to epidemic of obesity [2]. Some of this information, such as alcohol and tobacco use, is regularly documented by clinicians. Other information, such as dietary behaviors and physical activity, isn't typically captured, but may be tracked by new technology (such as wearable computers commonly referred to as "wearables") and integrated into electronic health records (EHRs). Such efforts may provide clinicians with additional context with which to counsel patients in an effort to increase their physical activity and reach a desired health outcome.

From a public health perspective, the same data obtained from these devices may be aggregated and used to guide decisions on public health policies. Continuing the prior example, proper amounts of physical activity will contribute to lower rates of mortality and chronic disease including coronary heart disease, hypertension, diabetes, breast cancer and depression across an entire population. Such data can be used to guide public health interventions in an evidence-based, cost-effective manner.

Both social and environmental factors are highly related to health. Social Determinants of Health (SDH) are non-clinical factors that affect the social and economic status of individuals and communities, including such items as their birthplace, living conditions, working conditions and demographic attributes [3]. Also included are social stressors such as crime, violence, and physical disorders, as well as others [4].

Environmental factors (i.e., air pollution, extreme weather, noise and poor indoor environmental quality) are highly related to an individual's health status. Densely built urban regions create air pollution, heat islands and high levels of noise, which have been implicated in causing or worsening a variety of health issues. For example, a study in New York City showed that asthma-related emergency admissions in youth from 5 to 17 years old were highly related to ambient ozone exposure. This annual NYC Community Health Survey also reveals that self-reported chronic health problems are related to extreme heat, suggesting that temperature can effect, or exacerbate, the symptoms of an individual's chronic illness. Social factors such as age and poverty levels also impact health. A study in New York City shows that fine particles (PM<sub>2.5</sub>, a surrogate marker for pollution) attributable asthma hospital admissions are 4.5 times greater in high-poverty neighborhoods [5].

While outdoor environmental conditions merit public health attention, the average American spends only an hour of each day outdoors, and most individuals live, work and rest in an indoor environment, where other concerns reside. Poor indoor quality can cause building related illness and "sick building syndrome" (SBS)—where occupants experience acute health issues and discomfort, while no diagnosable illness can be readily identified [6]. Again in New York City, housing data was combined from multiple agencies in an effort to address indoor pollution concerns—using predictive analytics, the city was able to increase the rate of detection of buildings considered dangerous, as well as improve the timeliness in locating apartments with safety concerns or health hazards [7].

## 6.3 Increasing Data Availability

For many years scientists and researchers have had to deal with very limited available data to study behavioral, social and environmental factors that exist in cities, as well as the difficulty in evaluating their model with a large pool of urban data [8]. The big data revolution is bringing vast volumes of data and paradigmatic transformations to many industries within urban services and operations. This is particularly true in commerce, security and health care, as more data are systematically gathered, stored, and analyzed. The emergence of urban informatics also coincides with a transition from traditionally closed and fragmented data systems to more fully connected and open data networks that include mass communications, citizen involvement (e.g. social media), and informational flow [9].

In 2008, 3.3 billion of the world's inhabitants lived in cities, representing, for the first time in history the majority of the human population [10]. In 2014, 54 % of population lives in urban area and it is expected to increase to 66 % by 2050 [11]. With the growth of cities, there are rising concerns in public health circles regarding the impact of associated issues such as aging populations, high population densities, inadequate sanitation, environmental degradation, climate change factors, an increasing frequency of natural disasters, as well as current and looming resource shortages. A concomitantly large amount of information is required to plan and provide for the public health of these urban entities, as well as to prevent and react to adverse public events of all types (e.g. epidemiological, natural, criminal and politico-terroristic disasters).

The nature of the city as an agglomeration of inhabitants, physical objects and activities makes it a rich source of urban data. Today, billions of individuals are generating the digital data through their cellphones and use of the Internet including social networks. Hardware like global positioning systems (GPS) and other sensors are also becoming ubiquitous as they become more affordable, resulting in diverse types of data being collected in new and unique ways [12]. This is especially true in cities due to their massive populations, creating hotspots of data generation and hubs of information flow. Such extensive data availability may also provide the substrate for more statistically robust models across multiple disciplines.

An overview of the volume, variety, and format of open urban data is essential to further integration with electronic health records. As more cities begin building their informational infrastructure, the volume of city data increases rapidly. The majority of urban data are in tabular format with location-based information [8]. Data source and collection processes vary based on the nature of urban data. Passive sensors continuously collect environmental data such as temperature, air quality, solar radiation, and noise, and construct an urban sensing infrastructure along with ubiquitous computing [13]. There is also a large amount of city data generated by citizens such as service requests and complaints. Some pre-existing data, like those in the appropriate tabular format, are immediately ready for integration, while other data contained in more complex file types, like Portable



Document Format (PDF) or others, are more difficult to parse. This problem can be compounded if the data are encoded in uncommon character languages.

The fact that many non-clinical data, especially urban data, is geo-located enables clinicians to consider patient health within a broader view. Many environmental, social and behavioral factors link together spatially, and such spatial correlation is a key measurement in epidemiology, as it allows for the facilitation of data integration based on location. Connections and solutions become more visible by linking non-clinical data with EHR on a public health and city planning level. Recently, IBM announced that, by teaming supercomputer Watson’s cognitive computing with data from CVS Health (a pharmacy chain with locations across the U.S.), we will have better predictions regarding the prevalence of chronic conditions such as heart disease and diabetes in different cities and locations [14].

## 6.4 Integration, Application and Calibration

In a summary of all cities in the United States that published open data sets as of 2013, it was found that greater than 75 % of datasets were prepared in tabular format [8]. Tabular data is most amenable for automated integration, as it is already in the final format prior to being integrated into most relational databases (as long as the dataset contains a meaningful attribute, or variable, with which to relate to other data entries). Furthermore, data integration occurs most easily when the dataset is “tidy”, or follows the rule of “one observation per row and one variable per column.” Any data manipulation process resulting in a dataset that is aggregated or summarized could remove a great deal of utility from that data [15].

For instance, a table that is familiar within one working environment may not be easily decipherable to another individual and may be nearly impossible for a machine to parse without proper context given for what is within the table. An example could be a table of blood pressure over time and in different locations for a number of patients, which may look like (Table 6.1).

Here we see two patients, Patient 1 and Patient 2, presenting to two locations, Random and Randomly, RA, on two different dates. While this table may be easily read by someone familiar with the format, such that an individual would understand that Patient 1 on the 1st of January, 2015, presented to a healthcare setting in Random, RA with a systolic blood pressure of 130 mmHg and a diastolic pressure of 75 mmHg, it may be rather difficult to manipulate these data to a tidy format without understanding the context of the table.

**Table 6.1** Example of a table requiring proper context to read

Patient blood pressure chart	Random, RA		Randomly, RA	
	1-Jan-15	7-Jan-15	1-Jan-15	7-Jan-15
Patient 1	130/75	139/83	141/77	146/82
Patient 2	158/95	151/91	150/81	141/84

If this table were to be manipulated in a manner that would make it easily analyzed by a machine (as well as other individuals without requiring an explanation of the context), it would follow the rule of one column per variable and one row per observation, as below (Table 6.2).

There are further limitations imparted due to data resolutions, which refers to the detail level of data in space, time or theme, especially the spatial dimension of the data [16]. Examples include: MM/DD/YY time formats compared to YYYY; or zip codes compared to geographic coordinates. Even with these limitations, one may still be able to draw relevant information from these spatial and temporal data.

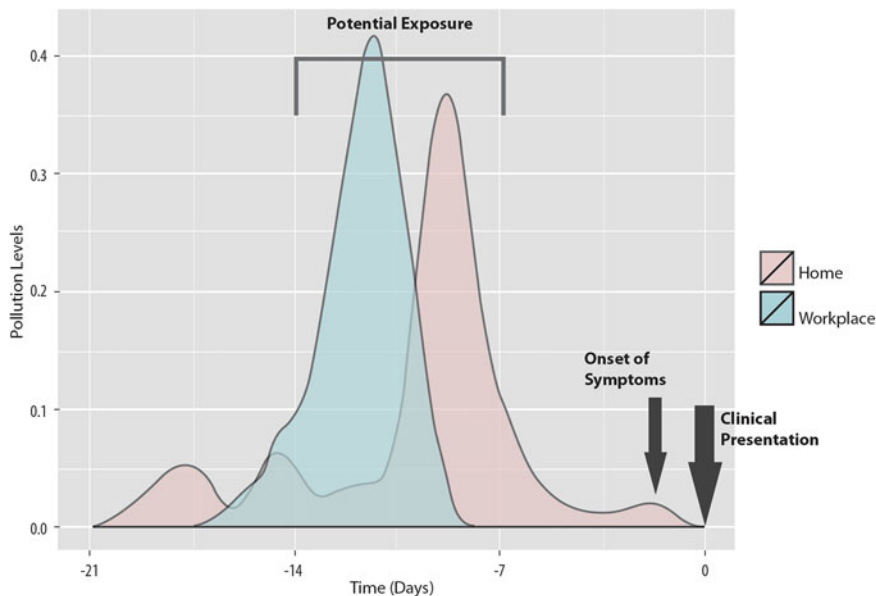
One method to provide spatial orientation to a clinical encounter has recently been adopted by the administrators of the Medical Information Mart for Intensive Care (MIMIC) database, which currently contains data from over 37,000 intensive care unit admissions [17]. Researchers utilize the United States Zip Code system to approximate the patients' area of residence. This method reports the first three digits of the patient's zip code, while omitting the last two digits [18]. The first three digits of a zip code contain two pieces of information: the first integer in the code refers to a number of states, the following two integers refer to a U.S. Postal Service Sectional Center Facility, through which the mail for that state's counties is processed [19]. The first three digits of the zip code are sufficient to find all other zip codes serviced by the Sectional Center Facility, and population level data of many types are available by zip code as per the U.S. Government's census [20].

**Table 6.2** A tidy dataset that contains a readily machine-readable format of the data in Table 6.1

Patient ID	Place	Date (MM/DD/YYYY)	Pressure (mmHg)	Cycle
1	Random, RA	1/1/2015	130	Systole
1	Random, RA	1/1/2015	75	Diastole
1	Random, RA	1/7/2015	139	Systole
1	Random, RA	1/7/2015	83	Diastole
1	Randomly, RA	1/1/2015	141	Systole
1	Randomly, RA	1/1/2015	77	Diastole
1	Randomly, RA	1/7/2015	146	Systole
1	Randomly, RA	1/7/2015	82	Diastole
2	Random, RA	1/1/2015	158	Systole
2	Random, RA	1/1/2015	95	Diastole
2	Random, RA	1/7/2015	151	Systole
2	Random, RA	1/7/2015	91	Diastole
2	Randomly, RA	1/1/2015	150	Systole
2	Randomly, RA	1/1/2015	81	Diastole
2	Randomly, RA	1/7/2015	141	Systole
2	Randomly, RA	1/7/2015	84	Diastole

Connections and solutions become more visible by linking non-clinical data with EHRs on a public health and city planning level. Although many previous studies show the correlation between air pollution and asthma, it is only recently individuals became able to trace PM<sub>2.5</sub>, SO<sub>2</sub> and Nickel (Ni) in the air back to the generators in buildings with aged boilers and heating systems, which is due in large part to increasing data collection and integration across multiple agencies and disciplines [21]. As studies reveal additional links between our environment and pathological processes, our ability to address potential health threats will be limited by our ability to measure these environmental factors in sufficient resolution to be able to apply it to patient level, creating truly personalized medicine.

For instance, two variables, commonly captured in many observations, are geo-spatiality and temporality. Since all actions share these conditions, integration is possible among a variety of data otherwise loosely utilized in the clinical encounter. When engaged in an encounter, a clinician can determine, from data collected during the examination and history taking, the precise location of the patient over a particular period of time within some spatial resolution. As a case example, a patient may present with an inflammatory process of the respiratory tract. The individual may live in random, RA, and work as an administrator in Randomly, RA; one can plot these variables over time, and separate them to represent both the individuals’ work and home environment—as well as other travel (Fig. 6.1).



**Fig. 6.1** Example of pollution levels over time for a patient’s “work” and “home” environment with approximate labels that may provide clinically relevant decision support

This same method may be applied to other variables that could be determined to have statistical correlates of significance during the timeframe prior to the onset of symptoms and then the clinical encounter.

With the increasing availability of information technology, there is less need for centralized information networks, and the opportunity is open for the individual to participate in data collection, creating virtual sensor networks of environmental and disease measurement. Mobile and social web have created powerful opportunities for urban informatics and disaster planning particularly in public health surveillance and crisis response [13]. There are geo-located mobile crowdsourcing applications such as Health Map's Outbreaks Near Me [22] and Sickweather [23] collecting data on a real-time social network.

In the 2014 Ebola Virus Disease outbreak, self-reporting and close contact reporting was essential to create accurate disease outbreak maps [24]. The emergence of wearables is pushing both EHR manufacturers to develop frameworks that integrate data from wearable devices, and third party companies to provide cloud storage and integration of data from different wearables for greater analytic power.

Attention and investment in digital health and digital cities continues to grow rapidly. In digital health care, investors' funding has soared from \$1.1 Billion in 2011 to \$5.0 Billion in 2014, and big data analytics ranks as the #1 most active subsector of digital healthcare startups in both amount of investment and number of deals [25]. Integration will be a long process requiring digital capabilities, new policies, collaboration between the public and private sectors, and innovations from both industry leaders and research institutions [26]. Yet we believe with more interdisciplinary collaborations in data mining and analytics, we will gain new knowledge on the health-associated non-clinical factors and indicators of disease outcomes [27]. Furthermore, such integration creates a feedback loop, pushing cities to collect better and larger amounts of data. Integrating non-clinical information into health records remains challenging. Ideally the information obtained from the patient would flow into the larger urban pool and vice versa. Challenges remain on protecting confidentiality at a single patient level and determining applicability of macroscopic data to the single patient.

## 6.5 A Well-Connected Empowerment

Disease processes can result and be modified by interactions of the patient and his or her environment. Understanding this environment is of importance to clinicians, hospitals, public health policy makers and patients themselves. With this information we can preempt patients at risk for disease (primary prevention), act earlier in minimizing morbidity from disease (secondary prevention) and optimize therapeutics.

A good example of the use of non-clinical data for disease prevention is the use of geographical based information systems (GIS) for preemptive screening of

populations at risk for sexually transmitted diseases (STDs). Geographical information systems are used for STD surveillance in about 50 % of state STD surveillance programs in the U.S. [28]. In Baltimore (Maryland, U.S.) a GIS based study identified core groups of repeat gonococcal (an STD) infection that showed geographical clustering [29]. The authors hinted at the possibility of increased yield when directing prevention to geographically restricted populations.

A logical next step is the interaction between public health authority systems and electronic medical records. As de-identified geographical health information becomes publically available, an electronic medical record would be able to download this information from the cloud, apply it to the patient's zip code, sex, age and sexual preference (if documented) and warn/cue the clinician that would decide if an intervention is required based on a calculated risk to acquire a STD.

## 6.6 Conclusion

Good data stewardship will be essential for protecting confidential health information from unintended and illegal disclosure. For patients, the idea of increasing empowerment in their health is essential [8]. Increasing sensor application and data visualization make our own behavior and surroundings more visible and tangible, and alert us about potential environmental risks. More importantly, it will help us to better understand and gain power over our own lives.

The dichotomy of addressing population health versus individual health must be addressed. Researchers should ask: what information is relevant to the target which I'm addressing, and what data do we feed from this patient's record into the public health realm? The corollary to that question is: how can we balance the individual's right to privacy with the benefit of non-clinical data applicable to the individual and to the large populations? Finally: how can we create systems that select relevant data from a single patient and present it to the clinician in a population-health context? In this chapter, we have attempted to provide an overview of the potential use of traditionally non-clinical data in electronic health records, in addition to mapping some of the pitfalls and strategies to using such data, as well as highlighting practical examples of the use of these data in a clinical environment.

**Open Access** This chapter is distributed under the terms of the Creative Commons Attribution-NonCommercial 4.0 International License (<http://creativecommons.org/licenses/by-nc/4.0/>), which permits any noncommercial use, duplication, adaptation, distribution and reproduction in any medium or format, as long as you give appropriate credit to the original author(s) and the source, a link is provided to the Creative Commons license and any changes made are indicated.

The images or other third party material in this chapter are included in the work's Creative Commons license, unless indicated otherwise in the credit line; if such material is not included in the work's Creative Commons license and the respective action is not permitted by statutory regulation, users will need to obtain permission from the license holder to duplicate, adapt or reproduce the material.

## References

1. Barton H, Grant M (2013) Urban planning for health cities, a review of the progress of the European healthy cities program. *J Urban Health Bull NY Acad Med* 90:129–141
2. Badland HM, Schofield GM, Witten K, Schluter PJ, Mavoa S, Kearns RA, Hinckson EA, Oliver M, Kawai H, Jensen VG, Ergler C, McGrath L, McPhee J (2009) Understanding the relationship between activity and neighborhoods (URBAN) study: research design and methodology. *BMC Pub Health* 9:244
3. Osypuk TL, Joshi P, Geronimo K, Acevedo-Garcia D (2014) Do social and economic policies influence health? *Rev Curr Epidemiol Rep* 1:149–164
4. Shmool JLC, Kubzansky LD, Newman OD, Spengler J, Shepard P, Clougherty JE (2014) Social stressors and air pollution across New York City communities: a spatial approach for assessing correlations among multiple exposures. *Environ Health* 13:91
5. Kheirbek I, Wheeler K, Walters S, Kass D, Matte T (2013) PM2.5 and ozone health impacts and disparities in New York City: sensitivity to spatial and temporal resolution. *Air Qual Atmos Health* 6:473–486
6. Indoor Air Facts No. 4 sick building syndrome. United States Environmental Protection Agency, Research and Development (MD-56) (1991)
7. Goldstein B, Dyson L (2013) Beyond transparency: open data and the future of civic innovation. Code for America Press, San Francisco
8. Barbosa L, Pham K, Silva C, Vieira MR, Freire J (2014) Structured open urban data: understanding the landscape. *Big Data* 2:144–154
9. Shane DG (2011) Urban design since 1945—a global perspective. Wiley, New York, p 284
10. National Intelligence Council (2012) Global trends 2030: alternative worlds. National Intelligence Council
11. World Urbanization Prospects, United Nations (2014)
12. Goldsmith S, Crawford S (2014) The responsive city: engaging communities through data-smart governance. Wiley, New York
- 13.oulos M, Resch B, Crowley D, Breslin J, Sohn G, Burtner R, Pike W, Jezierski E, Chuang K (2011) Crowdsourcing, citizen sensing and sensor web technologies for public and environmental health surveillance and crisis management: trends, OGC standards and application examples. *Int J Health Geographic* 10:67
14. McMullan T. Dr Watson: IBM plans to use Big Data to manage diabetes and obesity. URL: <http://www.alphr.com/life-culture/1001303/dr-watson-ibm-plans-to-use-big-data-to-manage-diabetes-and-obesity>
15. Wickham H (2014) Tidy data. *J Stat Softw* 10:59
16. Haining R (2004) Spatial data analysis—theory and practice. Cambridge University Press, Cambridge, p 67
17. MIMIC II Databases. Available from: <http://physionet.org/mimic2>. Accessed 02 Aug 2015
18. Massachusetts Institute of Technology, Laboratory of Computational Physiology. mimic2 v3.0 D\_PATIENTS table. URL: [https://github.com/mimic2/v3.0/blob/ad9c045a5a778c6eb283bdad310594484cca873c/\\_posts/2015-04-22-dpatients.md](https://github.com/mimic2/v3.0/blob/ad9c045a5a778c6eb283bdad310594484cca873c/_posts/2015-04-22-dpatients.md). Accessed 02 Aug 2015 (Archived by WebCite® at <http://www.webcitation.org/6aUNzhW6g>)
19. <http://pe.usps.com/businessmail101/glossary.htm>
20. <http://factfinder.census.gov/>
21. Jeffery N, McKelvey W, Matte T (2015) using tracking infrastructure to support public health programs, policies, and emergency response in New York City. *Pub Health Manag Pract* 21(2 Supp):S102–S106
22. <http://www.healthmap.org/outbreaksnearme/>
23. <http://www.sickweather.com>

24. Kouadio KI, Clement P, Bolongei J, Tamba A, Gasasira AN, Warsame A, Okeibunor JC, Ota MO, Tamba B, Gumede N, Shaba K, Poy A, Salla M, Mihigo R, Nshimirimana D (2015) Epidemiological and surveillance response to Ebola virus disease outbreak in Lofa County, Liberia (Mar–Sept 2014); lessons learned, edn 1. PLOS Currents Outbreaks. 6 May 2015. doi: [10.1371/currents.outbreaks.9681514e450dc8d19d47e1724d2553a5](https://doi.org/10.1371/currents.outbreaks.9681514e450dc8d19d47e1724d2553a5)
25. The re-imagination of healthcare. StartUp Health Insights. [www.startuphealth.com/insights](http://www.startuphealth.com/insights)
26. Ericsson Networked Society City Index (2014)
27. Corti B, Badland H, Mavoa S, Turrell G, Bull F, Boruff B, Pettit C, Bauman A, Hooper P, Villanueva K, Burt T, Feng X, Learnihan V, Davey R, Grenfell R, Thackway S (2014) Reconnecting urban planning with health: a protocol for the development and validation of national livability indicators associated with non-communicable disease risk behaviors and health outcomes. *Pub Health Res Pract* 25(1):e2511405
28. Bissette JM, Stover JA, Newman LM, Delcher PC, Bernstein KT, Matthews L (2009) Assessment of geographic information systems and data confidentiality guidelines in STD programs. *Pub Health Rep* 124(Suppl 2):58–64
29. Bernstein TK, Curriero FC, Jennings JM et al (2004) Defining core gonorrhea transmission utilizing spatial data. *Am J Epidemiol* 160:51–58

# Chapter 7

## Using EHR to Conduct Outcome and Health Services Research

Laura Myers and Jennifer Stevens

### Take Home Messages

- Electronic Health Records have become an essential tool in clinical research, both as a supplement to existing methods, but also in the growing domains of outcomes research and analytics.
- While EHR data is extensive and analytics are powerful, it is essential to fully understand the biases and limitations introduced when used in health services research.

### 7.1 Introduction

Data from electronic health records (EHR) can be a powerful tool for research. However, researchers must be aware of the fallibility of data collected for clinical purposes and of biases inherent to using EHR data to conduct sound health outcomes and health services research. Innovative methods are currently being developed to improve the quality of data and thus our ability to draw conclusions from studies that use EHR data.

The United States devotes a large share of the Gross Domestic Product (17.6 % in 2009) to health care [1]. With such a huge financial and social investment in healthcare, important questions are fundamental to evaluating this investment:

How do we know what treatment works and for which patients?

How much should health care cost? When is too much to pay? In what type of care should we invest more or less resources?

How does the health system work and how could it function better?

Health services research is a field of research that lives at the intersection of health care policy, management, and clinical care delivery and seeks to answer



these questions. Fundamentally, health services research places the health system under the microscope as the organism of study.

To begin to address these questions, researchers need large volumes of data across multiple patients, across different types of health delivery structures, and across time. The simultaneous growth of this field of research in the past 15 years has coincided with the development of the electronic health record and the increasing number of providers who make use of them in their workspace [2]. The EHR provides large quantities of raw data to fuel this research, both at the granular level of the patient and provider and at the aggregated level of the hospital, state, or nation.

Conducting research with EHR data has many challenges. EHR data are riddled with biases, collected for purposes other than research, inputted by a variety of users for the same patient, and difficult to integrate across health systems [See previous chapter “Confounding by Indication”]. This chapter will focus on the attempts to capitalize on the promise of the EHR for health services research with careful consideration of the challenges researchers must address to derive meaningful and valid conclusions.

## 7.2 The Rise of EHRs in Health Services Research

### 7.2.1 *The EHR in Outcomes and Observational Studies*

Observational studies, either retrospective or prospective, attempt to draw inferences about the effects of different exposures. Within health services research, these exposures include both different types of clinical exposures (e.g., does hormone replacement therapy help or hurt patients?) and health care delivery exposures (e.g., does admission to a large hospital for cardiac revascularization improve survival from myocardial infarction over admission to a small hospital). The availability of the extensive health data in electronic health records has fueled this type of research, as data extraction and transcription from paper records has ceased to be a barrier to research. These studies capitalize on the demographic and clinical elements that are routinely recorded as part of an encounter with the health system (e.g., age, sex, race, procedures performed, length of stay, critical care resources used).

We have highlighted a number of examples of this type of research below. Each one is an example of research that has made use of electronic health data, either at the national or hospital level, to draw inferences about health care delivery and care.

Does health care delivery vary? The researchers who compile and examine the Dartmouth Atlas have demonstrated substantial geographic variation in care. In their original article in *Science*, Wennberg and Gittlesohn noted wide variations in the use of health services in Vermont [3]. These authors employed data derived from the use of different types of medical services—home health services, inpatient discharges, etc.—to draw these inferences. Subsequent investigations into national variation in care have been able to capitalize on the availability of such data electronically [4].

Do hospitals with more experience in a particular area perform better? Birkmeyer and colleagues studied the intersection of hospital volume and surgical outcomes with absolute differences in adjusted mortality rates between low volume hospitals and high volume hospitals ranging from 12 % for pancreatic resection to 0.2 % for carotid endarterectomy [5]. Kahn et al. also used data available in over 20,000 patients to demonstrate that mortality associated with mechanical ventilation was 37 % lower in high volume hospitals compared with low volume hospitals [6]. Both of these research groups made use of large volumes of clinical and claims data—Medicare claims data in the case of Birkmeyer and colleagues and the APACHE database from Cerner for Kahn et al.—to ask important questions about where patients should seek different types of care.

How can we identify harm to patients despite usual care? Herzig and colleagues made use of the granular EHR at a single institution and found that the widely-prescribed medications that suppress acid production were associated with an increased risk of pneumonia [7]. Other authors have similarly looked at the EHR found that these types of medications are often continued on discharge from the hospital [8, 9].

To facilitate appropriate modeling and identification of confounders in observational studies, researchers have had to devise methods to extract markers of diagnoses, severity of illness, and patient comorbidities using only the electronic fingerprint. Post et al. [10] developed an algorithm to search for patients who had diuretic-refractory hypertension by querying for patients who had a diagnosis of hypertension despite 6 months treatment with a diuretic. Previously validated methods for reliably measuring the severity of a patient’s illness, such as APACHE or SAPS scores [11, 12], have data elements that are not easily extracted in the absence of manual inputting of data. To meet these challenges, researchers such as Escobar and Elixhauser have proposed alternative, electronically derived methods for both severity of illness measures [13, 14] and identification of comorbidities [14]. Escobar’s work, with a severity of illness measure with an area under the curve of 0.88, makes use of highly granular electronic data including laboratory values; Elixhauser’s comorbidity measure is publically available through the Agency for Healthcare Research and Quality and solely requires billing data [15].

Finally, researchers must develop and employ appropriate mathematical models that can accommodate the short-comings of electronic health data or else they risk drawing inaccurate conclusions. Examples of such modeling techniques are extensive have included propensity scores, causal methods such as marginal structural models and inverse probability weights, and designs from other fields such as instrumental variable analysis [16–19]. The details of these methods are discussed elsewhere in this text.

### ***7.2.2 The EHR as Tool to Facilitate Patient Enrollment in Prospective Trials***

Despite the power of the EHR to conduct health services and outcomes research retrospectively, the gold standard in research remains prospective and randomized trials. The EHR has functioned as a valuable tool to screen patients at a large scale

for eligibility. In this instance, research staff uses the data available through the electronic record as a high-volume screening technique to target recruitment efforts to the most appropriate patients. Clinical trials that develop electronic strategies for patient identification and recruitment are at an even greater advantage, although such robust methods have been described as sensitive but not specific, and frequently require coupling screening efforts with manual review of individual records [20]. Embi et al. [21] have proposed using the EHR to simultaneously generate Clinical Trial Alerts, particularly in commercial EHRs such as Epic to leverage the EHR in a point of care strategy. This strategy could expedite enrollment although it must be weighed against the risk of losing patient confidentiality, an ongoing tension between patient care and clinical trial enrollment [22].

### ***7.2.3 The EHR as Tool to Study and Improve Patient Outcomes***

Quality can also be tracked and reported through EHRs, either for internal quality improvement or for national benchmarking; the Veterans' Affairs' (VA) healthcare system highlights this. Byrne et al. [23] reported that in the 1990s, the VA spent more money on information technology infrastructure and achieved higher rates of adoption compared to the private sector. Their home-grown EHR, which is called VistA, provided a way to track preventative care processes such as cancer and diabetes screening through electronic pop up messages. Between 2004 and 2007, they found that the VA system achieved better glucose and lipid control for diabetics compared to a Medicare HMO benchmark [23]. While much capital investment was needed during the initial implementation of VistA, it is estimated that adopting this infrastructure saved the VA system \$3.09 billion in the long term. It also continues to be a source of quality improvement as quality metrics evolve over time [23].

## **7.3 How to Avoid Common Pitfalls When Using EHR to Do Health Services Research**

We would propose the following hypothetical research study as a case study to highlight common challenges to conducting health services research with electronic health data:

Proposed research study: Antipsychotic medications (e.g. haloperidol) are prescribed frequently in the intensive care unit to treat patients with active delirium. However, these medications have been associated with their own potential risk of harm [24] that is separate from the overall risk of harm from delirium. The researchers are interested in whether treatment with antipsychotics increases the risk of in-hospital death and increases the cost of care and use of resources in the hospital.

### 7.3.1 Step 1: Recognize the Fallibility of the EHR

The EHR is rarely complete or correct. Hogan et al. [25] tried to estimate how complete and accurate data are in studies that are conducted on an EHR, finding significant variability in both. Completeness ranged from 31 to 100 % and correctness ranged from 67 to 100 % [25]. Table 7.1 highlights examples of different diagnoses and possible sources of data, which may or may not be present for all patients.

Proposed research study: The researchers will need to extract which patients were exposed to antipsychotics and which were not. However, there is unlikely to be one single place where this information is stored. Should they use pharmacy dispensing data? Nursing administration data? Should they look at which patients were charged for the medications? What if they need these data from multiple hospitals with different electronic health records?

Additionally, even with a robust data extraction strategy, the fidelity of different types of data is variable [26–33]. For example, many EHR systems have the option of entering free text for a medical condition, which may be spelled wrong or be worded unconventionally. As another example, the relative reimbursement of a particular billing code may influence the incidence of that code in the electronic health record so billing may not reflect the true incidence and prevalence of the disease [34, 35].

### 7.3.2 Step 2: Understand Confounding, Bias, and Missing Data When Using the EHR for Research

We would highlight the following methodological issues inherent in conducting research with electronic health records: selection bias, confounding, and missing data. These are explored in greater depth in other chapters of this text.

**Table 7.1** Examples of the range of data elements that may be used to identify patients with either ischemic heart disease or acute lung injury through the electronic health record

Disease state	Data source	Example
Ischemic heart disease	Billing data	ICD-9 code 410 [48]
	Laboratory data	Positive troponin during admission
	Physician documentation	In the discharge summary: “the patient was noted to have ST elevations on ECG and was taken to the cath lab”...
Acute lung injury	Billing data	ICD-9 code 518.5 and 518.82 with the procedural codes 96.70, 96.71 and 96.72 for mechanical ventilation [49]
	Radiology data	“Bilateral” and “infiltrates” on chest x-ray reads [50]
	Laboratory data	PaO <sub>2</sub> /FiO <sub>2</sub> < 300 mmHg

Selection bias, or the failure of the population of study to represent the generalizable population, can occur if all the patients, including controls, are already seeking medical care within an EHR-based system. For example, in EHR-based studies comparing medical versus surgical approaches to the same condition may not be comparing equivalent patients in each group; patients seeking a surgical correction may fundamentally differ from those seeking a more conservative approach. Hripcsak et al. [36] used a large clinical data set from a tertiary center in 2007 to compare mortality from pneumonia to a hand-collected data set that had been published previously; the different search criteria altered the patient population and the subsequent risk of death. While it is not eliminated entirely, selection bias is reduced when prospective randomization takes place [37].

Confounding bias represents the failure to appropriately account for an additional variable that influences both the dependent and independent variable. In research with electronic health records, confounding represents a particular challenge, as identification of all possible confounding variables is nearly impossible.

Proposed research study: The researchers in this study are interested in the patient-level outcomes of what happens to those patients exposed to antipsychotics during their stay. But patients who are actively delirious while in the ICU are likely to be sicker than those who are not actively delirious and sicker patients require more hospital resources. As a result, antipsychotics will appear to be associated with a higher risk of in-hospital mortality and use of hospital resources not due to the independent effect of the drug but rather as a result of confounding by indication.

Missing data or unevenly sampled data collected as part of the EHR creates its own complex set of challenges for health services research. For example, restricting the analysis to patients with only a complete set of data may yield very different (and poorly generalizable) inferences. The multidimensionality of this problem often goes unexamined and underestimated. Nearly all conventional analytic software presumes completeness of the matrix of data, leading many researchers to fail to fully address these issues. For example, data can be misaligned due to lack of sampling, missing data, or simple misalignment. In other words, the data could not be measured during a period of time for an intentional reason (e.g., a patient was extubated and therefore no values for mechanical ventilation were documented) and should not be imputed or the data was measured but was unintentionally not recorded and therefore can be imputed. Rusanov et al. studied 10,000 outpatients at a tertiary center who underwent general anesthesia for elective procedures. Patients with a higher risk of adverse outcome going into surgery had more data points including laboratory values, medication orders and possibly admission orders compared to less sick patients [38], making the missing data for less sick patients intentional. Methods for handling missing data have included omitting cases are not complete, pairwise deletion, mean substitution, regression substitution, or using modeling techniques for maximum likelihood and multiple imputation [39].

## **7.4 Future Directions for the EHR and Health Services Research**

### ***7.4.1 Ensuring Adequate Patient Privacy Protection***

It is controversial whether using EHR for research goes against our national privacy standard. In large cohorts, many patients may be present with the same health information, thereby rendering the data sufficiently deidentified. Further, Ingelfinger et al. acknowledge that countries with healthcare registries such as Scandinavia have a distinct research advantage [40]. However, health information is a protected class of information under the Health Insurance Portability and Accountability Act, so there is significant awareness among U.S. healthcare professionals and researchers about its proper storage and dissemination. Some argue that patients should be consented (versus just notified) that their information could be used for research purposes in the future. Ingelfinger et al. [40] recommends IRB approval of registries and a rigorous deidentification process.

Public perception on the secondary use of EHR may not be as prohibitive as policymakers may have believed. In a survey of 3300 people, they were more willing to have their information used for research by university hospitals, compared to public health departments or for quality improvement purposes [41]. They were much less willing to contribute to marketing efforts or have the information used by pharmaceutical companies [41].

With the growing amount of information being entered into EHRs across the country, the American Medical Informatics Association convened a panel to make recommendations for how best to use EHR securely for purposes other than direct patient care. In 2006, the panel called for a national standard to deal with the issue of privacy. They described complex situations where there were security breaches due to problems with deidentification or data was being sold by physicians for profit [42]. While the panel demanded that the national framework be transparent, comprehensive and publicly accepted, they did not propose a particular standard at that time [42]. Other groups such as the Patient-Centered Outcomes Research Institute have since addressed the same conflict in a national forum in 2012. Similarly, while visions were discussed, no explicit recommendation was set forth [PCORI]. Controversy continues in this area.

## **7.5 Multidimensional Collaborations**

Going forward, the true power of integrated data can only be harnessed by forming more collaborations, both within institutions and between them. Research on a national scale in the U.S. has been shown to be feasible. The FDA implemented a pilot program in 2009 called the Mini-Sentinel program. It brought together 31 academic and private organizations to monitor for safety events related to

medications and devices currently on the market [43]. Admittedly, merging databases may require significant financial resources, especially if the datasets need to be coded and/or validated, but researchers like Bradley et al. [44] believe this is a cost-effective use of grant money because of the vast potential to make advances in the way we deliver care. Fundamental to the feasibility of multidimensional collaborations is the ability to ensure accuracy of large-scale data and integrate it across multiple health record technologies and platforms. Efforts to ensure data quality and accessibility must be promoted alongside patient privacy.

## 7.6 Conclusion

Researchers continue to ask fundamental questions of our health system, making use of the deluge of data generated by EHRs. Unfortunately, that deluge is messy and problematic. As the field of health services research with EHRs continues to evolve, we must hold researchers to rigorous standards [45] and encourage more investment in research-friendly clinical databases as well as cross-institutional collaborations. Only then will the discoveries in health outcomes and health services research be one click away [46, 47]. It is time for healthcare to reap the same reward from a rich data source that is already in existence.

**Open Access** This chapter is distributed under the terms of the Creative Commons Attribution-NonCommercial 4.0 International License (<http://creativecommons.org/licenses/by-nc/4.0/>), which permits any noncommercial use, duplication, adaptation, distribution and reproduction in any medium or format, as long as you give appropriate credit to the original author(s) and the source, a link is provided to the Creative Commons license and any changes made are indicated.

The images or other third party material in this chapter are included in the work's Creative Commons license, unless indicated otherwise in the credit line; if such material is not included in the work's Creative Commons license and the respective action is not permitted by statutory regulation, users will need to obtain permission from the license holder to duplicate, adapt or reproduce the material.

## References

1. Center for Medicare and Medicaid Services (2015) National health expenditure data fact sheet
2. Jha AK, DesRoches CM, Campbell EG, Donelan K, Rao SR et al (2009) Use of electronic health records in U.S. hospitals. *N Engl J Med* 360:1628–1638
3. Wennberg J, Gittelsohn (1973) Small area variations in health care delivery. *Science* 182:1102–1108
4. Stevens JP, Nyweide D, Maresh S, Zaslavsky A, Shrank W et al (2015) Variation in inpatient consultation among older adults in the United States. *J Gen Intern Med* 30:992–999
5. Birkmeyer JD (2000) Relation of surgical volume to outcome. *Ann Surg* 232:724–725
6. Kahn JM, Goss CH, Heagerty PJ, Kramer AA, O'Brien CR et al (2006) Hospital volume and the outcomes of mechanical ventilation. *N Engl J Med* 355:41–50

7. Herzig SJ, Howell MD, Ngo LH, Marcantonio ER (2009) Acid-suppressive medication use and the risk for hospital-acquired pneumonia. *JAMA* 301:2120–2128
8. Murphy CE, Stevens AM, Ferrentino N, Crookes BA, Hebert JC et al (2008) Frequency of inappropriate continuation of acid suppressive therapy after discharge in patients who began therapy in the surgical intensive care unit. *Pharmacotherapy* 28:968–976
9. Zink DA, Pohlman M, Barnes M, Cannon ME (2005) Long-term use of acid suppression started inappropriately during hospitalization. *Aliment Pharmacol Ther* 21:1203–1209
10. Post AR, Kurc T, Cholleti S, Gao J, Lin X et al (2013) The analytic information warehouse (AIW): a platform for analytics using electronic health record data. *J Biomed Inform* 46:410–424
11. Zimmerman JE, Kramer AA, McNair DS, Malila FM (2006) Acute physiology and chronic health evaluation (APACHE) IV: hospital mortality assessment for today's critically ill patients. *Crit Care Med* 34:1297–1310
12. Moreno RP, Metnitz PG, Almeida E, Jordan B, Bauer P et al (2005) SAPS 3—from evaluation of the patient to evaluation of the intensive care unit. Part 2: development of a prognostic model for hospital mortality at ICU admission. *Intensive Care Med* 31:1345–1355
13. Escobar GJ, Greene JD, Scheirer P, Gardner MN, Draper D et al (2008) Risk-adjusting hospital inpatient mortality using automated inpatient, outpatient, and laboratory databases. *Med Care* 46:232–239
14. Elixhauser A, Steiner C, Harris DR, Coffey RM (1998) Comorbidity measures for use with administrative data. *Med Care* 36:8–27
15. Project HCaU (2015) Comorbidity software, Version 3.7
16. Rubin DB, Thomas N (1996) Matching using estimated propensity scores: relating theory to practice. *Biometrics* 52:249–264
17. Rubin DB (1997) Estimating causal effects from large data sets using propensity scores. *Ann Intern Med* 127:757–763
18. Howell MD, Novack V, Grgurich P, Soulliard D, Novack L et al (2010) Iatrogenic gastric acid suppression and the risk of nosocomial *Clostridium difficile* infection. *Arch Intern Med* 170:784–790
19. Hernan MA, Brumback B, Robins JM (2000) Marginal structural models to estimate the causal effect of zidovudine on the survival of HIV-positive men. *Epidemiology* 11:561–570
20. Thadani SR, Weng C, Bigger JT, Ennever JF, Wajngurt D (2009) Electronic screening improves efficiency in clinical trial recruitment. *J Am Med Inform Assoc* 16:869–873
21. Embi PJ, Jain A, Clark J, Harris CM (2005) Development of an electronic health record-based clinical trial alert system to enhance recruitment at the point of care. *AMIA Annu Symp Proc*, 231–235
22. PCORnet (2015) Rethinking clinical trials: a living textbook of pragmatic clinical trials
23. Byrne CM, Mercincavage LM, Pan EC, Vincent AG, Johnston DS et al (2010) The value from investments in health information technology at the U.S. Department of Veterans Affairs. *Health Aff (Millwood)* 29:629–638
24. Ray WA, Chung CP, Murray KT, Hall K, Stein CM (2009) Atypical antipsychotic drugs and the risk of sudden cardiac death. *N Engl J Med* 360:225–235
25. Hogan WR, Wagner MM (1997) Accuracy of data in computer-based patient records. *J Am Med Inform Assoc* 4:342–355
26. Lee DS, Donovan L, Austin PC, Gong Y, Liu PP et al (2005) Comparison of coding of heart failure and comorbidities in administrative and clinical data for use in outcomes research. *Med Care* 43:182–188
27. Iwashyna TJ, Odden A, Rohde J, Bonham C, Kuhn L et al (2014) Identifying patients with severe sepsis using administrative claims: patient-level validation of the angus implementation of the international consensus conference definition of severe sepsis. *Med Care* 52:e39–e43
28. Jones G, Taright N, Boelle PY, Marty J, Lalande V et al (2012) Accuracy of ICD-10 codes for surveillance of *clostridium difficile* infections, France. *Emerg Infect Dis* 18:979–981
29. Kramer JR, Davila JA, Miller ED, Richardson P, Giordano TP et al (2008) The validity of viral hepatitis and chronic liver disease diagnoses in Veterans Affairs Administrative databases. *Aliment Pharmacol Ther* 27:274–282



30. van de Garde EM, Oosterheert JJ, Bonten M, Kaplan RC, Leufkens HG (2007) International classification of diseases codes showed modest sensitivity for detecting community-acquired pneumonia. *J Clin Epidemiol* 60:834–838
31. Movig KL, Leufkens HG, Lenderink AW, Egberts AC (2003) Validity of hospital discharge International classification of diseases (ICD) codes for identifying patients with hyponatremia. *J Clin Epidemiol* 56:530–535
32. Sickbert-Bennett EE, Weber DJ, Poole C, MacDonald PD, Maillard JM (2010) Utility of international classification of diseases, ninth revision, clinical modification codes for communicable disease surveillance. *Am J Epidemiol* 172:1299–1305
33. Jung MA, Banerjee SN (2009) Administrative coding data and health care-associated infections. *Clin Infect Dis* 49:949–955
34. O'Malley KJ, Cook KF, Price MD, Wildes KR, Hurdle JF et al (2005) Measuring diagnoses: ICD code accuracy. *Health Serv Res* 40:1620–1639
35. Richesson RL, Rusincovitch SA, Wixted D, Batch BC, Feinglos MN et al (2013) A comparison of phenotype definitions for diabetes mellitus. *J Am Med Inform Assoc* 20:e319–e326
36. Hripcsak G, Knirsch C, Zhou L, Wilcox A, Melton G (2011) Bias associated with mining electronic health records. *J Biomed Discov Collab* 6:48–52
37. Hernan MA, Alonso A, Logan R, Grodstein F, Michels KB et al (2008) Observational studies analyzed like randomized experiments: an application to postmenopausal hormone therapy and coronary heart disease. *Epidemiology* 19:766–779
38. Rusanov A, Weiskopf NG, Wang S, Weng C (2014) Hidden in plain sight: bias towards sick patients when sampling patients with sufficient electronic health record data for research. *BMC Med Inform Decis Mak* 14:51
39. Allison PD (2001) Missing data. Sage Publishers, Thousand Oaks
40. Ingelfinger JR, Drazen JM (2004) Registry research and medical privacy. *N Engl J Med* 350:1452–1453
41. Grande D, Mitra N, Shah A, Wan F, Asch DA (2013) Public preferences about secondary uses of electronic health information. *JAMA Intern Med* 173:1798–1806
42. Safran C, Bloomrosen M, Hammond WE, Labkoff S, Markel-Fox S et al (2007) Toward a national framework for the secondary use of health data: an American medical informatics association white paper. *J Am Med Inform Assoc* 14:1–9
43. Platt R, Carnahan RM, Brown JS, Chrischilles E, Curtis LH et al (2012) The U.S. food and drug administration's mini-sentinel program: status and direction. *Pharmacoepidemiol Drug Saf* 21(Suppl 1):1–8
44. Bradley CJ, Penberthy L, Devers KJ, Holden DJ (2010) Health services research and data linkages: issues, methods, and directions for the future. *Health Serv Res* 45:1468–1488
45. Kahn MG, Raebel MA, Glanz JM, Riedlinger K, Steiner JF (2012) A pragmatic framework for single-site and multisite data quality assessment in electronic health record-based clinical research. *Med Care* 50(Suppl):S21–S29
46. Weber GM, Mandl KD, Kohane IS (2014) Finding the missing link for big biomedical data. *JAMA* 311:2479–2480
47. Murdoch TB, Detsky AS (2013) The inevitable application of big data to health care. *JAMA* 309:1351–1352
48. Birman-Deych E, Waterman AD, Yan Y, Nilasena DS, Radford MJ et al (2005) Accuracy of ICD-9-CM codes for identifying cardiovascular and stroke risk factors. *Med Care* 43:480–485
49. Reynolds HN, McCunn M, Borg U, Habashi N, Cottingham C et al (1998) Acute respiratory distress syndrome: estimated incidence and mortality rate in a 5 million-person population base. *Crit Care* 2:29–34
50. Herasevich V, Tsapenko M, Kojicic M, Ahmed A, Kashyap R et al (2011) Limiting ventilator-induced lung injury through individual electronic medical record surveillance. *Crit Care Med* 39:34–39

# Chapter 8

## Residual Confounding Lurking in Big Data: A Source of Error

John Danziger and Andrew J. Zimolzak

### Take Home Messages

- Any observational study may have unidentified confounding variables that influence the effects of the primary exposure, therefore we must rely on research transparency along with thoughtful and careful examination of the limitations to have confidence in any hypotheses.
- Pathophysiology is complicated and often obfuscates the measured data with many observations being mere proxies for a physiological process and many different factors progressing to similar dysfunction.

## 8.1 Introduction

Nothing is more dangerous than an idea, when you have only one...

—Emile Chartier

Big Data is defined by its vastness, often with large highly granular datasets, which when combined with advanced analytical and statistical approaches, can power very convincing conclusions [1]. Herein perhaps lies the greatest challenge with using big data appropriately: understanding what is not available. In order to avoid false inferences of causality, it is critical to recognize the influences that might affect the outcome of interest, yet are not readily measurable.

Given the difficulty in performing well-designed prospective, randomized studies in clinical medicine, Big Data resources such as the Medical Information Mart for Intensive Care (MIMIC) database [2] are highly attractive. They provide a powerful resource to examine the strength of potential associations and to test

whether assumed physiological principles remain robust in clinical medicine. However, given their often observational nature, causality can not be established, and great care should be taken when using observational data to influence practice patterns. There are numerous examples [3, 4] in clinical medicine where observational data had been used to determine clinical decision making, only to eventually be disproven, and in the meantime, potentially causing harm. Although associations may be powerful, missing the unseen connections leads to false inferences. The unrecognized effect of an additional variable associated with the primary exposure that influences the outcome of interest is known as confounding.

## 8.2 Confounding Variables in Big Data

Confounding is often referred to as a “mixing of effects” [5] wherein the effects of the exposure on a particular outcome are associated with an additional factor, thereby distorting the true relationship. In this manner, confounding may falsely suggest an apparent association when no real association exists. Confounding is a particular threat in observational data, as is often the case with Big Data, due to the inability to randomize groups to the exposure. The process of randomization essentially mitigates the influence of unrecognized influences, because these influences should be nearly equally distributed to the groups. However, more frequently observational data is composed of patient groups that have been distinguished based on clinical factors. For example, with critical care observational data, such as MIMIC, such “non-random allocation” has occurred simply by reaching the intensive care unit (ICU). There has been some decision process by an admitting team, perhaps in the Emergency Department, that the patient is ill enough for the ICU. That decision process is likely influenced by a host of factors, some of which are identifiable, as in blood pressure and severity of illness, and others that are not, as in “the patient just looks sick” intuition of the provider.

### 8.2.1 *The Obesity Paradox*

As an example of the subtlety of this confounding influence, let’s tackle the question of obesity as a predictor of mortality. In most community-based studies [6, 7], obesity is associated with poorer outcomes: obese patients have a higher risk of dying than normal weighted individuals likely mediated by an increased incidence of diabetes, hypertension, and cardiovascular disease. However, amongst patients admitted to the ICU, obesity is a strong survival benefit [8, 9], with multiple studies elucidated better outcomes amongst obese critically ill patients than normal weighted critical ill patients.

There are potentially many explanations for this paradoxical association. On one hand, it is plausible that critically ill obese patients have higher nutritional stores and are better able to withstand the prolonged state of cachexia associated with critical illness than normal weighted patients. However, let's explore some other possibilities. Since obesity is typically defined by the body mass index (BMI) upon admission to the ICU, it is possible that unrecognized influences on body weight prior to hospitalization that independently affect outcome might be the true reason for this paradoxical association. For example, fluid accumulation, as might occur with congestive heart failure, will increase body weight, but not fat mass, resulting in an inappropriately elevated BMI. This fluid accumulation, when resulting in pulmonary edema, is generally considered a marker of illness severity and warrants a higher level of care, such as the ICU. Thus, this fluid accumulation would prompt the emergency room team to admit the patient to the ICU rather than to the general medicine ward. Now, heart failure is typically a reasonably treatable disease process. Diuretics are an effective widely used treatment, and likely can resolve the specific factor (i.e. fluid overload) that leads to ICU care. Thus, such a patient would seem obese, but might not be, and would have a reasonable chance of survival. Compare that to another such patient, who developed cachexia from metastatic cancer, and lost thirty pounds prior to presenting to the emergency room. That patient's BMI would have dropped significantly over the few weeks prior to illness, and his poor prognosis and illness might lead to an ICU admission, where his prognosis would be poor. In the latter scenario, concluding that a low BMI was associated with a poor outcome may not be strictly correct, since it is often rather the complications of the underlying cancer that lead to mortality.

### **8.2.2 Selection Bias**

Let's explore one last possibility relating to how the obesity paradox in critical care might be confounded. Imagine two genetically identical fraternal twins with the exact same comorbidities and exposures, presenting with cellulitis, weakness, and diarrhea, both of whom will need frequent cleaning and dressing changes. The only difference is that one twin has a normal weight, whereas the other is morbidly obese. Now, the emergency room team must decide which level of care these patients require. Given the challenges of caring for morbidly obese patient (lifting a heavy leg, turning to change), it is plausible that obesity itself might influence the emergency room's choice regarding disposition. In that case, there would be a tremendous selection bias. In essence, the obese patient who would have been generally healthy enough for a general ward ends up in the ICU due to obesity alone, where the observational data begins. Not surprisingly, that patient will do better than other ICU patients, since he was healthier in the first place and was admitted simply because he was obese.

Such selection bias, which can be quite subtle, is a challenging problem in non-randomly allocated studies. Patients groups are often differentiated by their

illness severity, and thus any observational study assessing the effects of related treatments may fail to address underlying associated factors. For example, a recent observational Big Data study attempted to examine whether exposure to proton pump inhibitors (PPI) was associated with hypomagnesemia [10]. Indeed, in many thousands of examined patients, PPI users had lower admission serum magnesium concentrations. Yet, the indication for why the patients were prescribed PPIs in the first place was not known. Plausibly, patients who present with dyspepsia or other related gastrointestinal symptoms, which are major indications for PPI prescription, might have lower intake of magnesium-containing foods. Thus, the conclusion that PPI was responsible for lower magnesium concentrations would be conjecture, since lower dietary intake would be an equally reasonable explanation.

### 8.2.3 *Uncertain Pathophysiology*

In addition to selection bias, as illustrated in the obesity paradox and PPI associated hypomagnesemia examples, there is another important source of confounding, particularly in critical care studies. Given that physiology and pathophysiology are such strong determinants of outcomes in critical illness, the ability to fully account for the underlying pathophysiologic pathways is extraordinarily important, but also notoriously difficult. Consider that clinicians caring for patients, standing at the patient's bedside in direct examination of all the details, sometimes cannot explain the physiologic process. Recognizing diastolic heart failure remains challenging. Accurately characterizing organ function is not straightforward. And if the caring physician can't delineate the underlying processes, how can observational data, so removed from the patient? It can't, and this is a huge source of potential mistakes. Let's consider some examples.

In critical care, the frequent laboratory studies that are easily measured with precise reproducibility make a welcoming target for cross sectional analysis. In the literature, almost every common laboratory abnormality has been associated with a poor outcome, including abnormalities of sodium, potassium, chloride, bicarbonate, blood urea nitrogen, creatinine, glucose, hemoglobin, etc. Many of these cross sectional studies have led to management guidelines. The important question however is whether the laboratory abnormality itself leads to a poor patient outcome, or whether instead, the underlying patient pathophysiology that leads to the laboratory abnormality is the primary cause.

Take for example hyponatremia. There is extensive observational data linking hyponatremia to mortality. In response, there have been extensive treatment guidelines on how to correct hyponatremia through a combination of water restriction and sodium administration [11]. However, the mechanistic explanation for how chronic and/or mild hyponatremia might cause a poor outcome is not totally convincing. Some data might suggest that potential subtle cerebral edema might lead to imbalance and falls, but this is not a completely convincing explanation for the association of admission hyponatremia with in-hospital death.



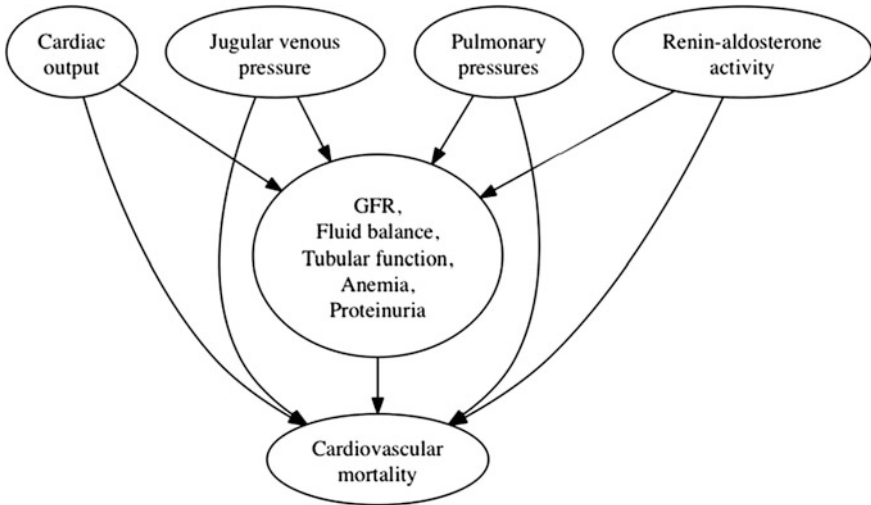
**Fig. 8.1** Concept map of the association of kidney function, as determined by the glomerular filtration rate, as a determinant of cardiovascular mortality

Many cross-sectional studies have not addressed the underlying reason for hyponatremia in the first place. Most often, hyponatremia is caused by sensed volume depletion, as might occur in liver disease and heart disease. Sensed volume is a concept describing the body’s internal measure of intravascular volume, which directly affects the body’s sodium avidity, and which under certain conditions affects its water avidity. Sensed volume is quite difficult to determine clinically, and there are no billing or diagnostic codes to describe it. Therefore, even though sensed volume is the strongest determinant of serum sodium concentrations in large population studies, it is not a capturable variable, and thus it cannot be included as a covariate in adjusted analyses. Its absence likely leads to false conclusions. As of now, despite a plethora of studies showing that hyponatremia is associated with poor outcomes, we collectively can not conclude whether it is the water excess itself, or the underlying cardiac or liver pathophysiologic abnormalities that cause the hyponatremia, that is of greater importance.

Let us consider another very important example. There have been a plethora of studies in the critical care literature linking renal function to a myriad of outcomes [12, 13]. One undisputed conclusion is that impaired renal function is associated with increased cardiovascular mortality, as illustrated in Fig. 8.1.

However, this association is really quite complex, with a number of important confounding issues that undermine this conclusion. The first issue is how accurately a serum creatinine measurement reflects the glomerular filtration rate (GFR). Calculations such as the Modification of Diet in Renal Disease (MDRD) equation were developed as epidemiologic tools to estimate GFR [14] but do not accurately define underlying renal physiology. Furthermore, even if one considers the serum creatinine as a measure of GFR, there are multiple other aspects of kidney functions beyond the GFR, including sodium and fluid balance, erythropoietin and activated vitamin D production, and tubular function, none of which are easily measurable, and thus cannot be accounted for.

However, in addition to confounding due to an inability to accurately characterize “renal function,” significant residual confounding due to unaccounted pathophysiology is equally problematic. In relation to the association of renal function with cardiovascular mortality, there are many determinants of cardiac function that simultaneously and independently influence both the serum creatinine



**Fig. 8.2** Concept map of the association of renal function and cardiovascular mortality revealing more of the confounding influences

concentration and cardiovascular outcomes. For example, increased jugular venous pressures are a strong determinant of cardiac outcome and influence renal function through renal vein congestion. Cardiac output, pulmonary artery pressures, and activation of the renin-angiotensin-aldosterone axis also likely influence both renal function and cardiac outcomes. The concept map is likely more similar to Fig. 8.2.

Since many of these variables are rarely measured or quantified in large epidemiologic studies, significant residual confounding likely exists, and potential bias by failing to appreciate the complexity of the underlying pathophysiology is likely.

Multiple statistical techniques have been developed to account for residual confounding to non-randomization and to underlying severity of illness in critical care. Propensity scores, which attempt to better capture the factors that lead to the non-randomized allocation (i.e. the factors which influence the decision to admit to the ICU or to expose to a PPI) are used widely to minimize selection bias [15]. Adjustment using variables that attempt to capture severity of illness, such as the Simplified Acute Physiology Score (SAPS) [16], or the Sequential/ Sepsis-related Organ Failure Assessment (SOFA) score [17], or comorbidity adjustment scores, such as Charlson or Elixhauser [18, 19], remain imprecise, as does risk adjustment with area under the receiver operating characteristic curve (AUROC). Ultimately, significant confounding cannot be adjusted away by the most sophisticated statistical techniques, and thoughtful and careful examination of the limitations of any observational study must be transparent.

## 8.3 Conclusion

In summary, tread gently when harvesting the power of Big Data, for what is not seen is exactly what may be of most interest. Be clear about the limitations of using observational data, and suggest that most observational studies are hypothesis generating and require more well designed studies to better address the question at hand.

**Open Access** This chapter is distributed under the terms of the Creative Commons Attribution-NonCommercial 4.0 International License (<http://creativecommons.org/licenses/by-nc/4.0/>), which permits any noncommercial use, duplication, adaptation, distribution and reproduction in any medium or format, as long as you give appropriate credit to the original author(s) and the source, a link is provided to the Creative Commons license and any changes made are indicated.

The images or other third party material in this chapter are included in the work's Creative Commons license, unless indicated otherwise in the credit line; if such material is not included in the work's Creative Commons license and the respective action is not permitted by statutory regulation, users will need to obtain permission from the license holder to duplicate, adapt or reproduce the material.

## References

1. Bourne PE (2014) What big data means to me. *J Am Med Inf Assoc.* 21(2):194–194
2. Saeed M, Villarroel M, Reisner AT, Clifford G, Lehman L-W, Moody G et al (2011) Multiparameter intelligent monitoring in intensive care II: a public-access intensive care unit database. *Crit Care Med* 39(5):952–960
3. Patel CJ, Burford B, Ioannidis JPA (2015) Assessment of vibration of effects due to model specification can demonstrate the instability of observational associations. *J Clin Epidemiol* 68 (9):1046–1058
4. Tzoulaki I, Siontis KCM, Ioannidis JPA (2011) Prognostic effect size of cardiovascular biomarkers in datasets from observational studies versus randomised trials: meta-epidemiology study. *BMJ* 343:d6829
5. Greenland S (2005) Confounding. In: Armitage P, Colton T (eds) *Encyclopedia of biostatistics*, 2nd edn.
6. National Task Force on the Prevention and Treatment of Obesity (2000) Overweight, obesity, and health risk. *Arch Intern Med* 160(7):898–904
7. Berrington de Gonzalez A, Hartge P, Cerhan JR, Flint AJ, Hannan L, MacInnis RJ et al (2010) Body-mass index and mortality among 1.46 million white adults. *N Engl J Med* 363 (23):2211–2219
8. Hutagalung R, Marques J, Kobylka K, Zeidan M, Kabisch B, Brunkhorst F et al (2011) The obesity paradox in surgical intensive care unit patients. *Intensive Care Med* 37(11):1793–1799
9. Pickkers P, de Keizer N, Dusseljee J, Weerheijm D, van der Hoeven JG, Peek N (2013) Body mass index is associated with hospital mortality in critically ill patients: an observational cohort study. *Crit Care Med* 41(8):1878–1883
10. Danziger J, William JH, Scott DJ, Lee J, Lehman L-W, Mark RG et al (2013) Proton-pump inhibitor use is associated with low serum magnesium concentrations. *Kidney Int* 83(4): 692–699
11. Verbalis JG, Goldsmith SR, Greenberg A, Korzelius C, Schrier RW, Sterns RH et al (2013) Diagnosis, evaluation, and treatment of hyponatremia: expert panel recommendations. *Am J Med* 126(10 Suppl 1):S1–S42



12. Apel M, Maia VPL, Zeidan M, Schinkoethe C, Wolf G, Reinhart K et al (2013) End-stage renal disease and outcome in a surgical intensive care unit. *Crit Care* 17(6):R298
13. Matsushita K, van der Velde M, Astor BC, Woodward M, Levey AS et al (2010) Chronic kidney disease prognosis consortium. Association of estimated glomerular filtration rate and albuminuria with all-cause and cardiovascular mortality in general population cohorts: a collaborative meta-analysis. *Lancet* 375(9731):2073–2081
14. Levey AS, Bosch JP, Lewis JB, Greene T, Rogers N, Roth D (1999) A more accurate method to estimate glomerular filtration rate from serum creatinine: a new prediction equation. Modification of diet in renal disease study group. *Ann Intern Med* 130(6):461–470
15. Gayat E, Pirracchio R, Resche-Rigon M, Mebazaa A, Mary J-Y, Porcher R (2010) Propensity scores in intensive care and anaesthesiology literature: a systematic review. *Intensive Care Med* 36(12):1993–2003
16. Le Gall JR, Lemeshow S, Saulnier F (1993) A new simplified acute physiology score (SAPS II) based on a European/North American multicenter study. *JAMA* 270(24):2957–2963
17. Vincent JL, Moreno R, Takala J, Willatts S, De Mendonça A, Bruining H et al (1996) The SOFA (sepsis-related organ failure assessment) score to describe organ dysfunction/failure. On behalf of the working group on sepsis-related problems of the European society of intensive care medicine. *Intensive Care Med* 22(7):707–710
18. Charlson ME, Pompei P, Ales KL, MacKenzie CR (1987) A new method of classifying prognostic comorbidity in longitudinal studies: development and validation. *J Chronic Dis* 40(5):373–383
19. Elixhauser A, Steiner C, Harris DR, Coffey RM (1998) Comorbidity measures for use with administrative data. *Med Care* 36(1):8–27

## Part II

# A Cookbook: From Research Question Formulation to Validation of Findings

The first part of this textbook has given the reader a general perspective about Electronic Health Records (EHRs), their potential for medical research and use for retrospective data analyses. Part II focuses on the use of one particular EHR, the Medical Information Mart for Intensive Care (MIMIC) database, curated by the Laboratory for Computational Physiology at MIT. The readers will have an opportunity to develop their analytical skills for clinical data mining while following a complete research project, from the initial definition of a research question to the assessment of the final results' robustness. This part is designed like a cookbook, with each chapter comprising some theoretical concepts, followed by worked examples using MIMIC. Part III of this book will be dedicated to a variety of different case studies to further your understanding of more advanced analysis methods.

This part is subdivided into nine chapters that follow the common process of generating new medical evidence using clinical data mining. In Chap. 9, the reader will learn how to transform a clinical question into a pertinent research question, which includes defining an appropriate study design and select the exposure and outcome of interest. In Chap. 10, the researcher will learn how to define which patient population is most relevant for investigating the research question. Owing to the essential and often challenging aspect of analysis of EHRs, it will be described in the following four chapters elaborately. Chapters 11 and 12 deal with the essential task of data preparation and pre-processing, which is mandatory before any data can be fed into a statistical analysis tool. Chapter 11 explains how a database is structured, what type of data they can contain and how to extract the variables of interest using queries; Chap. 12 presents some common methods of data pre-processing, which usually implies cleaning, integrating, then reducing the data; Chap. 13 provides various methods for dealing with missing data; Chap. 14 discusses techniques to identify and handle outliers. In Chap. 15, common methods for exploring the data are presented, both numerical and graphical. Exploration data analysis gives the researcher some invaluable insight into the features and potential

issues of a dataset, and can help with generating further hypotheses. Chapter 16, “data analysis”, presents the theory and methods for model development (Sect. 16.1) as well as common data analysis techniques in clinical studies, namely linear regression (Sect. 16.2), logistic regression (Sect. 16.3) and survival analysis including Cox proportional hazards models (Sect. 16.4). Finally, Chap. 17 discusses the principles of model validation and sensitivity analyses, where the results of a particular research are tested for robustness in the face of varying model assumptions.

Each chapter includes worked examples inspired from a unique study, published in *Chest* in 2015 by Hsu et al., which addressed a key question in clinical practice in intensive care medicine: “is the placement of an indwelling arterial catheter (IAC) associated with reduced mortality, in patients who are mechanically ventilated but do not require vasopressor support?” IACs are used extensively in the intensive care unit for continuous monitoring of blood pressure and are thought to be more accurate and reliable than standard, non-invasive blood pressure monitoring. They also have the added benefit of allowing for easier arterial blood gas collection which can reduce the need for repeated arterial punctures. Given their invasive nature, however, IACs carry risks of bloodstream infection and vascular injury, so the evidence of a beneficial effect requires evaluation. The primary outcome of interest selected was 28-day mortality with secondary outcomes that included ICU and hospital length-of-stay, duration of mechanical ventilation, and mean number of blood gas measurements made. The authors identified the encounter-centric ‘arterial catheter placement’ as their exposure of interest and carried out a propensity score analysis to test the relationship between the exposure and outcomes using MIMIC. The result in this particular dataset (spoiler alert) is that the presence of an IAC is not associated with a difference in 28-day mortality, in hemodynamically stable patients who are mechanically ventilated. This case study provides a basic foundation to apply the above theory to a working example, and will give the reader first-hand perspective on various aspects of data mining and analytical techniques. This is in no way a comprehensive exploration of EHR analytics and, where the case lacks the necessary detail, we have attempted to include additional relevant information for common analytical techniques. For the interested reader, references are provided for more detailed readings.

# Chapter 9

## Formulating the Research Question

Anuj Mehta, Brian Malley and Allan Walkey

### Learning Objectives

- Understand how to turn a clinical question into a research question.
- Principles of choosing a sample.
- Approaches and potential pitfalls.
- Principles of defining the exposure of interest.
- Principles of defining the outcome.
- Selecting an appropriate study design.

### 9.1 Introduction

The clinical question arising at the time of most health-care decisions is: “will this help my patient?” Before embarking on an investigation to provide data that may be used to inform the clinical question, the question must be modified into a research query. The process of developing a research question involves defining several components of the study and also what type of study is most suited to utilize these components to yield valid and reliable results. These components include: in whom is this research question relevant? The population of subjects defined by the researcher is referred to as the sample. The drug, maneuver, event or characteristic that we are basing our alternative hypothesis on is called the exposure of interest. Finally, the outcome of interest must be defined. With these components in mind the researcher must decide which study design is best or most feasible for answering the question. If an observational study design is chosen, then the choice of a database is also crucial.

In this chapter, we will explore how researchers might work through converting a clinical question into a research question using the clinical scenario of indwelling

arterial catheters (IAC) use during mechanical ventilation (MV). Furthermore, we will discuss the strengths and weaknesses of common study designs including randomized controlled trials as well as observational studies.

## 9.2 The Clinical Scenario: Impact of Indwelling Arterial Catheters

Patients who require MV because they are unable to maintain adequate breathing on their own (e.g. from severe pneumonia or asthma attack) are often the sickest patients in the hospital, with mortality rates exceeding 30 % [1–3]. Multiple options are available to monitor the adequacy of respiratory support for critically ill patients requiring MV, ranging from non-invasive trans-cutaneous measures to invasive, indwelling monitoring systems. IACs are invasive monitoring devices that allow continuous real time blood pressure monitoring and facilitate access to arterial blood sampling to assess arterial blood pH, oxygen and carbon dioxide levels, among others [4–6]. While closer monitoring of patients requiring MV with IACs may appear at face value to be beneficial, IACs may result in severe adverse events, including loss of blood flow to the hand and infection [7, 8]. Currently, data is lacking whether benefits may outweigh risks of more intensive monitoring using IACs. Examining factors associated with the decision to use IACs, and outcomes in patients provided IACs as compared to non-invasive monitors alone, may provide information useful to clinicians facing the decision as to whether to place an IAC.

## 9.3 Turning Clinical Questions into Research Questions

The first step in the process of transforming a clinical question into research is to carefully define the **study sample (or patient cohort)**, the **exposure** of interest, and the **outcome** of interest. These 3 components—sample, exposure, and outcome—are essential parts of every research question. Slight variations in each component can dramatically affect the conclusions that can be drawn from any research study, and whether the research will appropriately address the overarching clinical question.

### 9.3.1 Study Sample

In the case of IAC use, one might imagine many potential study samples of interest: for example, one might include all ICU patients, all patients receiving MV, all patients receiving intravenous medications that strongly affect blood pressure, adults only, children only, etc. Alternatively, one could define samples based on specific diseases or syndrome, such as shock (where IACs may be used to closely

monitor blood pressure) or severe asthma (where IAC may be used to monitor oxygen or carbon dioxide levels).

The choice of study sample will affect both the internal and the external validity (generalizability) of the study. A study focusing only on a pediatric population may not apply to the adult population. Similarly, a study focused on patients receiving MV may not be applicable to non-ventilated patients. Furthermore, a study including patients with different reasons for using an IAC, with different outcomes related to the reason for IAC use, may lack internal validity due to bias called ‘confounding’. Confounding is a type of study bias in which an exposure variable is associated with both the exposure and the outcome.

For instance, if the benefits of IACs on mortality are studied in all patients receiving MV, researchers must take into account the fact that IAC placement may actually be indicative of greater severity of illness. For example, imagine a study with a sample of MV patients in which those with septic shock received an IAC to facilitate vasoactive medications and provide close blood pressuring monitoring while patients with asthma did not receive an IAC as other methods were used to monitor their ventilation (such as end-tidal CO<sub>2</sub> monitoring). Patients with septic shock tend to have a much higher severity of illness compared to patients with asthma regardless of whether an IAC is placed. In such a study, researchers may conclude that IACs are associated with higher mortality only because IACs were used in sicker patients with a higher risk of dying. The variable “diagnosis” is therefore a confounding factor, associated with both the exposure (decision to insert an IAC) and the outcome (death). Careful sample selection is one method of attempting to address issues of confounding related to severity of illness. Restricting study samples to exclude groups that may strongly confound results (i.e. no patients on vasoactive medications) is one strategy to reduce bias. However, the selection of homogeneous study samples to increase internal validity should be balanced with the desire to generalize study findings to broader patient populations. These principles are discussed more extensively in the Chap. 10—“Cohort Selection”.

### 9.3.2 *Exposure*

The exposure in our research question appears to be fairly clear: placement of an IAC. However, careful attention should be paid as to how each exposure or variable of interest is defined. Misclassifying exposures may bias results. How should IAC be measured? For example, investigators may use methods ranging from direct review of the medical chart to use of administrative claims data (i.e. International Classification of Diseases—ICD-codes) to identify IAC use. Each method of ascertaining the exposure of interest may have pros (improved accuracy of medical chart review) and cons (many person-hours to perform manual chart review).

Defining the time window during which an exposure of interest is measured may also have substantial implications that must be considered when interpreting the research results. For the purposes of our IAC study, the presence of an IAC was

defined as having an IAC placed after the initiation of MV. The time-dependent nature of the exposure is critical for answering the clinical question; some IACs placed prior to MV are for monitoring of low-risk surgical patients in the operating room. Including all patients with IACs regardless of timing may bias the results towards a benefit for IACs by including many otherwise healthy patients who had an IAC placed for surgical monitoring. Alternatively, if the exposure group is defined as patients who had an IAC at least 48 h after initiation of MV, the study is at risk for a type of confounding called “immortal time bias”: only patients who were alive could have had an IAC placed, whereas patients dying prior to 48 h (supposedly sicker) could not have had an IAC.

Equally important to defining the group of patients who received or experienced an exposure is to define the “unexposed” or control group. While not all research requires a control group (e.g. epidemiologic studies), a control group is needed to assess the effectiveness of healthcare interventions. In the case of the IAC study, the control group is fairly straightforward: patients receiving MV who did not have an IAC placed. However, there are important nuances when defining control groups. In our study example, an alternate control group could be all ICU patients who did not receive an IAC. However, the inclusion of patients not receiving MV results in a control group with a lower severity of illness and expected mortality than patients receiving MV, which would bias in favor of not using IACs. Careful definition of the control group is needed to properly interpret any conclusions from research; defining an appropriate control group is as important as defining the exposure.

### **9.3.3 Outcome**

Finally, the investigator needs to determine the outcome of interest. Several different types of outcomes can be considered, including intermediate or mechanistic outcomes (informs etiological pathways, but may not immediately impact patients), patient-centered outcomes (informs outcomes important to patients, but may lack mechanistic insights: e.g. comfort scales, quality of life indices, or mortality), or healthcare-system centered outcomes (e.g. resource utilization, or costs). In our example of IAC use, several outcomes could be considered including intermediate outcomes (e.g. number of arterial blood draws, ventilator setting changes, or vasoactive medication changes), patient-centered outcomes (e.g. 28-day or 90-day mortality, adverse event rates), or healthcare utilization (e.g. hospitalization costs, added clinician workload). As shown in our example, outcome(s) may build upon each other to yield a constellation of findings that provides a more complete picture to address the clinical question of interest.

After clearly defining the study sample, exposure of interest, and outcome of interest, a research question can be formulated. A research question using our example may be formulated as follows:

*“In the population of interest (study cohort), is the exposure to the variable of interest associated with a different outcome than in the control group?”*, which becomes, in our example:

*“Among mechanically ventilated, adult ICU patients who are not receiving vasoactive medications (i.e., the study sample) is placement of an IAC after initiation of MV (as compared with not receiving an IAC) (i.e. the exposure and control patients) associated with improved 28-day mortality rates (primary outcome, patient-centered) and the number of blood gas measurements per day (supporting secondary outcome, intermediate/mechanistic)?”*

## 9.4 Matching Study Design to the Research Question

Once the research question has been defined, the next step is to choose the optimal study design given the question and resources available. In biomedical research, the gold-standard for study design remains the double-blinded, randomized, placebo-controlled trial (RCT) [9, 10]. In a RCT, patients with a given condition (e.g. all adults receiving MV) would be randomized to receive a drug or intervention of interest (e.g. IAC) or randomized to receive the control (e.g. no IAC), with careful measurement of pre-determined outcomes (e.g. 28-day mortality). In ideal conditions, the randomization process eliminates all measured and unmeasured confounding and allows for causal inferences to be drawn, which cannot generally be achieved without randomization. As shown above, confounding is a threat to valid inferences from study results. Alternatively, in our example of septic shock versus asthma, severity of illness associated with the underlying condition may represent another confounder. Randomization solely based on the exposure of interest attempts to suppress issues of confounding. In our examples, proper randomization in a large sample would theoretically create equal age distributions and equal numbers of patients with septic shock and asthma in both the exposure and the control group.

However, RCTs have several limitations. Although the theoretical underpinnings of RCTs are fairly simple, the complex logistics of patient enrollment and retention, informed consent, randomization, follow up, and blinding may result in RCTs deviating from the ‘ideal conditions’ necessary for unbiased, causal inference. Additionally, RCTs carry the highest potential for patient harm and require intensive monitoring because the study dictates what type of treatment a patient receives (rather than the doctor) and may deviate from routine care. Given the logistic complexity, RCTs are often time- and cost-intensive, frequently taking many years and millions of dollars to complete. Even when logistically feasible, RCTs often ‘weed out’ multiple groups of patients in order to minimize potential harms and maximize detection of associations between interventions and outcomes of interest. As a result, RCTs can consist of homogeneous patients meeting narrow criteria, which may reduce the external validity of the studies’ findings. Despite much effort



and cost, an RCT may miss relevance to the clinical question as to whether the intervention of interest is helpful for your particular patient or not. Finally, some clinical questions may not ethically be answered with RCTs. For instance, the link between smoking and lung cancer has never been shown in a RCT, as it is unethical to randomize patients to start smoking in a smoking intervention group, or randomize patients to a control group in a trial to investigate the efficacy of parachutes [11]!

Observational research differs from RCTs. Observational studies are non-experimental; researchers record routine medical practice patterns and derive conclusions based on correlations and associations without active interventions [9, 12]. Observational studies can be retrospective (based on data that has already been collected), prospective (data is actively collected over time), or ambi-directional (a mix). Unlike RCTs, researchers in observational studies have no role in deciding what types of treatments or interventions patients receive. Observational studies tend to be logistically less complicated than RCTs as there is no active intervention, no randomization, no data monitoring boards, and data is often collected retrospectively. As such, observational studies carry less risk of harm to patients (other than loss of confidentiality of data that has been collected) than RCTs, and tend to be less time- and cost-intensive. Retrospective databases like MIMIC-II [13] or the National Inpatient Sample [14] can also provide much larger study samples (tens of thousands in some instances) than could be enrolled in an RCT, thus providing larger statistical power. Additionally, broader study samples are often included in observational studies, leading to greater generalizability of the results to a wider range of patients (external validity). Finally, certain clinical questions that would be unethical to study in an RCT can be investigated with observational studies. For example, the link between lung cancer and tobacco use has been demonstrated with multiple large prospective epidemiological studies [15, 16] and the life-saving effects of parachutes have been demonstrated mostly through the powers of observation.

Although logistically simpler than RCTs, the theoretical underpinnings of observational studies are generally more complex than RCTs. Obtaining causal estimates of the effect of a specific exposure on a specific outcome depends on the philosophical concept of the ‘counterfactual’ [17]. The counterfactual is the situation in which, all being equal, the same research subject at the same time would receive the exposure of interest and (the counterfactual) not receive the exposure of interest, with the same outcome measured in the exposed and unexposed research subject. Because we cannot create cloned research subjects in the real-world, we rely on creating groups of patients similar to the group that receives an intervention of interest. In the case of an ideal RCT with a large enough number of subjects, the randomization process used to select the intervention and control groups creates two alternate ‘universes’ of patients that will be similar except as related to the exposure of interest. Because observational studies cannot intervene on study subjects, observational studies create natural experiments in which the counterfactual group is defined by the investigator and by clinical processes occurring in the real-world. Importantly, real-world clinical processes often occur for a reason,

and these reasons can cause deviation from counterfactual ideals in which exposed and unexposed study subjects differ in important ways. In short, observational studies may be more prone to bias (problems with internal validity) than RCTs due to difficulty obtaining the counterfactual control group.

Several types of biases have been identified in observational studies. Selection bias occurs when the process of selecting exposed and unexposed patients introduces a bias into the study. For example, the time between starting MV and receiving IAC may introduce a type of “survivor treatment selection bias” since patients who received IAC could not have died prior to receiving IACs. Information bias stems from mismeasurement or misclassification of certain variables. For retrospective studies, the data has already been collected and sometimes it is difficult to evaluate for errors in the data. Another major bias in observational studies is confounding. As stated, confounding occurs when a third variable is correlated with both the exposure and outcome. If the third variable is not taken into consideration, a spurious relationship between the exposure and outcome may be inferred. For example, smoking is an important confounder in several observational studies as it is associated with several other behaviors such as coffee and alcohol consumption. A study investigating the relationship between coffee consumption and incidence of lung cancer may conclude that individuals who drink more coffee have higher rates of lung cancer. However, as smoking is associated with both coffee consumption and lung cancer, it is confounder in the relationship between coffee consumption and lung cancer if unmeasured and unaccounted for in analysis. Several methods have been developed to attempt to address confounding in observational research such as adjusting for the confounder in regression equations if it is known and measured, matching cohorts by known confounders, and using instrumental variables—methods that will be explained in-depth in future chapters. Alternatively, one can restrict the study sample (e.g. excluding patients with shock from a study evaluating the utility of IACs). For these reasons, while powerful, an individual observational study can, at best, demonstrate associations and correlations and cannot prove causation. Over time, a cumulative sum of multiple high quality observational studies coupled with other mechanistic evidence can lead to causal conclusions, such as in the causal link currently accepted between smoking and lung cancer established by observational human studies and experimental trials in animals.

## 9.5 Types of Observational Research

There are multiple different types of questions that can be answered with observational research (Table 9.1). Epidemiological studies are one major type of observational research that focuses on the burden of disease in predefined populations. These types of studies often attempt to define incidence, prevalence, and risk factors for disease. Additionally, epidemiological studies also can investigate changes to healthcare or diseases over time. Epidemiological studies are the cornerstone of public health and can heavily influence policy decisions, resource

**Table 9.1** Major types of observational research, and their purpose

Type of observational research	Purpose
Epidemiological	Define incidence, prevalence, and risk factors for disease
Predictive modeling	Predict future outcomes
Comparative effectiveness	Identify intervention associated with superior outcomes
Pharmacovigilance	Detect rare drug adverse events occurring in the long-term

allocation, and patient care. In the case of lung cancer, predefined groups of patients without lung cancer were monitored for years until some patients developed lung cancer. Researchers then compared numerous risk factors, like smoking, between those who did and did not develop lung cancer which led to the conclusion that smoking increased the risk of lung cancer [15, 16].

There are other types of epidemiological studies that are based on similar principles of observational research but differ in the types of questions posed. Predictive modeling studies develop models that are able to accurately predict future outcomes in specific groups of patients. In predictive studies, researchers define an outcome of interest (e.g. hospital mortality) and use data collected on patients such as labs, vital signs, and disease states to determine which factors contributed to the outcome. Researchers then validate the models developed from one group of patients in a separate group of patients. Predictive modeling studies developed many common prediction scores used in clinical practice such as the Framingham Cardiovascular Risk Score [18], APACHE IV [19], SAPS II [20], and SOFA [21].

Comparative effectiveness research is another form of observational research which involves the comparison of existing healthcare interventions in order to determine effective methods to deliver healthcare. Unlike descriptive epidemiologic studies, comparative effectiveness research compares outcomes between similar patients who received different treatments in order to assess which intervention may be associated with superior outcomes in real-world conditions. This could involve comparing drug A to drug B or could involve comparing one intervention to a control group who did not receive that intervention. Given that there are often underlying reasons why one patient received treatment A versus B or an intervention versus no intervention, comparative effectiveness studies must meticulously account for potential confounding factors. In the case of IACs, the research question comparing patients who had an IAC placed to those who did not have an IAC placed would represent a comparative effectiveness study.

Pharmacovigilance studies are yet another form of observational research. As many drug and device trials end after 1 or 2 years, observational methods are used to evaluate if there are patterns of rarer adverse events occurring in the long-term. Phase IV clinical studies are one form of pharmacovigilance studies in which long-term information related to efficacy and harm are gathered after the drug has been approved.

## 9.6 Choosing the Right Database

A critical part of the research process is deciding what types of data are needed to answer the research question. Administrative/claims data, secondary use of clinical trial data, prospective epidemiologic studies, and electronic health record (EHR) systems (both from individual institutions and those pooled from multiple institutions) are several sources from which databases can be built. Administrative or claims databases, such as the National Inpatient Sample and State Inpatient Databases compiled by the Healthcare Cost and Utilization Project or the Medicare database, contain information on patient and hospital demographics as well as billing and procedure codes. Several techniques have been developed to translate these billing and procedure codes to more clinically useful disease descriptions. Administrative databases tend to provide very large sample sizes and, in some cases, can be representative of an entire population. However, they lack granular patient-level data from the hospitalization such as vital signs, laboratory and microbiology data, timing data (such as duration of MV or days with an IAC) or pharmacology data, which are often important in dealing with possible confounders.

Another common source of data for observational research is large epidemiologic studies like the Framingham Heart Study as well as large multicenter RCTs such as the NIH ARDS Network. Data that has already been can be analyzed retrospectively with new research questions in mind. As the original data was collected for research purposes, these types of databases often have detailed, granular information not available in other clinical databases. However, researchers are often bound by the scope of data collection from the original research study which limits the questions that may be posed. Importantly, generalizability may be limited in data from trials.

The advent of Electronic Health Records (EHR) has resulted in the digitization of medical records from their prior paper format. The resulting digitized medical records present opportunities to overcome some of the shortcomings of administrative data, yielding granular data with laboratory results, medications, and timing of clinical events [13]. These “big databases” take advantage of the fact many EHRs collect data from a variety of sources such as patient monitors, laboratory systems, and pharmacy systems and coalesce them into one system for clinicians. This information can then be translated into de-identified databases for research purposes that contain detailed patient demographics, billing and procedure information, timing data, hospital outcomes data, as well as patient-level granular data and provider notes which can searched using natural language processing tools. “Big data” approaches may attenuate confounding by providing detailed information needed to assess severity of illness (such as lab results and vital signs). Furthermore, the granular nature of the data can provide insight as to the reason why one patient received an intervention and another did not which can partly address confounding by indication. Thus, the promise of “big data” is that it contains small, very detailed data. “Big data” databases, such as MIMIC-III, have the potential to expand the scope of what had previously been possible with observational research.

## 9.7 Putting It Together

Fewer than 10 % of clinical decisions are supported by high level evidence [22]. Clinical questions arise approximately in every other patient [23] and provide a large cache of research questions. When formulating a research question, investigators must carefully select the appropriate sample of subjects, exposure variable, outcome variable, and confounding variables. Once the research question is clear, study design becomes the next pivotal step. While RCTs are the gold standard for establishing causal inference under ideal conditions, they are not always practical, cost-effective, ethical or even possible for some types of questions. Observational research presents an alternative to performing RCTs, but is often limited in causal inference by unmeasured confounding.

Our clinical scenario gave rise to the question of whether IACs improved the outcomes of patients receiving MV. This translated into the research question: “Among mechanically ventilated ICU patients not receiving vasoactive medications (study sample) is use of an IAC after initiation of MV (exposure) associated with improved 28-day mortality (outcome)?” While an RCT could answer this question, it would be logistically complex, costly, and difficult. Using comparative effectiveness techniques, one can pose the question using a granular retrospective database comparing patients who received an IAC to measurably similar patients who did not have an IAC placed. However, careful attention must be paid to unmeasured confounding by indication as to why some patients received IAC and others did not. Factors such as severity of illness, etiology of respiratory failure, and presence of certain diseases that make IAC placement difficult (such as peripheral arterial disease) may be considered as possible confounders of the association between IAC and mortality. While an administrative database could be used, it could lack important information related to possible confounders. As such, EHR databases like MIMIC-III, with detailed granular patient-level data, may allow for measurement of a greater number of previously unmeasured confounding variables and allow for greater attenuation of bias in observational research.

### Take Home Messages

- Most research questions arise from clinical scenarios in which the proper course of treatment is unclear or unknown.
- Defining a research question requires careful consideration of the optimal study sample, exposure, and outcome in order to answer a clinical question of interest.
- While observational research studies can overcome many of the limitations of randomized controlled trials, careful consideration of study design and database selection is needed to address bias and confounding.

**Open Access** This chapter is distributed under the terms of the Creative Commons Attribution-NonCommercial 4.0 International License (<http://creativecommons.org/licenses/by-nc/4.0/>), which permits any noncommercial use, duplication, adaptation, distribution and reproduction in any medium or format, as long as you give appropriate credit to the original author(s) and the source, a link is provided to the Creative Commons license and any changes made are indicated.

The images or other third party material in this chapter are included in the work's Creative Commons license, unless indicated otherwise in the credit line; if such material is not included in the work's Creative Commons license and the respective action is not permitted by statutory regulation, users will need to obtain permission from the license holder to duplicate, adapt or reproduce the material.

## References

1. Esteban A, Frutos-Vivar F, Muriel A, Ferguson ND, Peñuelas O, Abaira V, Raymondos K, Rios F, Nin N, Apezteguía C, Violi DA, Thille AW, Brochard L, González M, Villagomez AJ, Hurtado J, Davies AR, Du B, Maggiore SM, Pelosi P, Soto L, Tomicic V, D'Empaire G, Matamis D, Abroug F, Moreno RP, Soares MA, Arabi Y, Sandi F, Jibaja M, Amin P, Koh Y, Kuiper MA, Bülow H-H, Zeggwagh AA, Anzueto A (2013) Evolution of mortality over time in patients receiving mechanical ventilation. *Am J Respir Crit Care Med* 188(2):220–230
2. Mehta A, Syeda SN, Wiener RS, Walkey AJ (2014) Temporal trends in invasive mechanical ventilation: severe sepsis/pneumonia, heart failure and chronic obstructive pulmonary disease. In: B23. Clinical trials and outcomes, vols 271. American Thoracic Society, pp. A2537–A2537
3. Stefan MS, Shieh M-S, Pekow PS, Rothberg MB, Steingrub JS, Lagu T, Lindenauer PK (2013) Epidemiology and outcomes of acute respiratory failure in the United States, 2001 to 2009: a national survey. *J Hosp Med* 8(2):76–82
4. Traoré O, Liotier J, Souweine B (2005) Prospective study of arterial and central venous catheter colonization and of arterial- and central venous catheter-related bacteremia in intensive care units. *Crit Care Med* 33(6):1276–1280
5. Gershengorn HB, Garland A, Kramer A, Scales DC, Rubenfeld G, Wunsch H (2014) Variation of arterial and central venous catheter use in United States intensive care units. *Anesthesiology* 120(3):650–664
6. Gershengorn HB, Wunsch H, Scales DC, Zarychanski R, Rubenfeld G, Garland A (2014) Association between arterial catheter use and hospital mortality in intensive care units. *JAMA Intern Med* 174(11):1746–1754
7. Maki DG, Kluger DM, Crnich CJ (2006) The risk of bloodstream infection in adults with different intravascular devices: a systematic review of 200 published prospective studies. *Mayo Clin Proc* 81(9):1159–1171
8. Scheer BV, Perel A, Pfeiffer UJ (2002) Clinical review: complications and risk factors of peripheral arterial catheters used for haemodynamic monitoring in anaesthesia and intensive care medicine. *Crit Care* 6(3):199–204
9. Concato J, Shah N, Horwitz RI (2000) Randomized, controlled trials, observational studies, and the hierarchy of research designs. *N Engl J Med* 342(25):1887–1892
10. Ho PM, Peterson PN, Masoudi FA (2008) Evaluating the evidence is there a rigid hierarchy? *Circulation* 118(16):1675–1684
11. Smith GCS, Pell JP (2003) Parachute use to prevent death and major trauma related to gravitational challenge: systematic review of randomised controlled trials. *BMJ* 327(7429):1459–1461
12. Booth CM, Tannock IF (2014) Randomised controlled trials and population-based observational research: partners in the evolution of medical evidence. *Br J Cancer* 110(3):551–555

13. Scott DJ, Lee J, Silva I, Park S, Moody GB, Celi LA, Mark RG (2013) Accessing the public MIMIC-II intensive care relational database for clinical research. *BMC Med Inform Decis Mak* 13(1):9
14. Healthcare Cost and Utilization Project and Agency for Healthcare Research and Quality. Overview of the National (Nationwide) Inpatient Sample (NIS)
15. Doll R, Hill AB (1954) The mortality of doctors in relation to their smoking habits; a preliminary report. *Br Med J* 1(4877):1451–1455
16. Alberg AJ, Samet JM (2003) Epidemiology of lung cancer. *Chest* 123(1 Suppl):21S–49S
17. Maldonado G, Greenland S (2002) Estimating causal effects. *Int J Epidemiol* 31(2):422–429
18. Wilson PWF, D’Agostino RB, Levy D, Belanger AM, Silbershatz H, Kannel WB (1998) Prediction of coronary heart disease using risk factor categories. *Circulation* 97(18):1837–1847
19. Zimmerman JE, Kramer AA, McNair DS, Malila FM (2006) Acute physiology and chronic health evaluation (APACHE) IV: hospital mortality assessment for today’s critically ill patients. *Crit Care Med* 34(5):1297–1310
20. Le Gall JR, Lemeshow S, Saulnier F (1993) A new simplified acute physiology score (SAPS II) based on a European/North American multicenter study. *JAMA* 270(24):2957–2963
21. Vincent JL, Moreno R, Takala J, Willatts S, De Mendonça A, Bruining H, Reinhart CK, Suter PM, Thijs LG (1996) The SOFA (sepsis-related organ failure assessment) score to describe organ dysfunction/failure. On behalf of the working group on sepsis-related problems of the European society of intensive care medicine. *Intensive Care Med* 22(7):707–710
22. Tricoci P, Allen JM, Kramer JM, Califf RM, Smith SC (2009) Scientific evidence underlying the ACC/AHA clinical practice guidelines. *JAMA* 301(8):831–841
23. Del Fiol G, Workman TE, Gorman PN (2014) Clinical questions raised by clinicians at the point of care: a systematic review. *JAMA Intern Med* 174(5):710–718

# Chapter 10

## Defining the Patient Cohort

Ari Moskowitz and Kenneth Chen

### Learning Objectives

- Understand the process of cohort selection using large, retrospective databases.
- Learn about additional specific skills in cohort building including data visualization and natural language processing (NLP).

### 10.1 Introduction

A critical first step in any observational study is the selection of an appropriate patient cohort for analysis. The importance of investing considerable time and effort into selection of the study population cannot be overstated. Failure to identify areas of potential bias, confounding, and missing data up-front can lead to considerable downstream inefficiencies. Further, care must be given to selecting a population of patients tailored to the research question of interest in order to properly leverage the tremendous amount of data captured by Electronic Health Records (EHRs).

In the following chapter we will focus on selection of the study cohort. Specifically, we will review the basics of observational study design with a focus on types of data often encountered in EHRs. Commonly used instrumental variables will be highlighted—they are variables used to control for confounding and measurement error in observational studies. Further, we will discuss how to utilize a combination of data-driven techniques and clinical reasoning in cohort selection. The chapter will conclude with a continuation of the worked example started in part

---

**Electronic supplementary material** The online version of this chapter (doi:[10.1007/978-3-319-43742-2\\_10](https://doi.org/10.1007/978-3-319-43742-2_10)) contains supplementary material, which is available to authorized users.



one of this section where we will discuss how the cohort of patients was selected for the study of arterial line placement in the intensive care unit [1].

## 10.2 PART 1—Theoretical Concepts

### 10.2.1 *Exposure and Outcome of Interest*

These notions are discussed in detail in Chap. 9—“Formulating the Research Question”. Data mining in biomedical research utilizes a retrospective approach wherein the exposure and outcome of interest occur prior to patient selection. It is critically important to tailor the exposure of interest sought to the clinical question at hand. Selecting an overly broad exposure may allow for a large patient cohort, but at the expense of result accuracy. Similarly, being too specific in the choice of exposure may allow for accuracy but at the expense of sample size and generalizability.

The selection of an exposure of interest is the first step in determining the patient cohort. In general, the exposure of interest can be thought of as patient-centric, episode-centric, or encounter centric. This terminology was developed by the data warehousing firm Health Catalyst for their Cohort Builder tool and provides a reasonable framework for identifying an exposure of interest. Patient-centric exposures focus on traits intrinsic to a group of patients. These can include demographic traits (e.g. gender) or medical comorbidities (e.g. diabetes). In contrast, episode-centric exposures are transient conditions requiring a discrete treatment course (e.g. sepsis). Encounter-centric exposures refer to a single intervention (e.g. arterial line placement) [2]. Although encounter-specific exposures tend to be simpler to isolate, the choice of exposure should be determined by the specific hypothesis under investigation.

The outcome of interest should be identified a priori. The outcome should relate naturally to the exposure of interest and be as specific as possible to answer the clinical question at hand. Care must be taken to avoid identifying spurious correlations that have no pathophysiologic underpinnings (see for instance the examples of spurious correlations shown on <http://tylervigen.com>). The relationship sought must be grounded in biologic plausibility. Broad outcome measures, such as mortality and length-of-stay, may be superficially attractive but ultimately confounded by too many variables. Surrogate outcome measures (e.g. change in blood pressure, duration of mechanical ventilation) can be particularly helpful as they relate more closely to the exposure of interest and are less obscured by confounding.

As EHRs are not frequently oriented towards data mining and analysis, identifying an exposure of interest can be challenging. Structured numerical data, such as laboratory results and vital signs, are easily searchable with standard querying techniques. Leveraging unstructured data such as narrative notes and radiology reports can be more difficult and often requires the use of natural language processing (NLP) tools. In order to select a specific patient phenotype from a large, heterogeneous group of patients, it can be helpful to leverage both structured and unstructured data forms.

Once an exposure of interest is selected, the investigator must consider how to utilize one or a combination of these data types to isolate the desired study cohort for analysis. This can be done using a combination of data driven techniques and clinical reasoning as will be reviewed later in the chapter.

### ***10.2.2 Comparison Group***

In addition to isolating patients mapping to the exposure of interest, the investigator must also identify a comparison group. Ideally, this group should be comprised of patients phenotypically similar to those in the study cohort but who lack the exposure of interest. The selected comparison cohort should be at equal risk of developing the study outcome. In observational research, this can be accomplished notably via propensity score development (Chap. 23—“Propensity Score Analysis”). In general, the comparison group ought to be as large as or larger than the study cohort to maximize the power of the study. It is possible to select too many features on which to ‘match’ the comparison and study cohorts thereby reducing the number of patients available for the comparison cohort. Care must be taken to prevent over-matching.

In select cases, investigators can take advantage of natural experiments in which circumstances external to the EHR readily establish a study cohort and a comparison group. These so called ‘instrumental variables’ can include practice variations between care units, hospitals, and even geographic regions. Temporal relationships (i.e. before-and-after) relating to quality improvement initiatives or expert guideline releases can also be leveraged as instrumental variables. Investigators should be on the lookout for these highly useful tools.

### ***10.2.3 Building the Study Cohort***

Isolating specific patient phenotypes for inclusion in the study and comparison cohorts requires a combination of clinical reasoning and data-driven techniques. A close working relationship between clinicians and data scientists is an essential component of cohort selection using EHR data.

The clinician is on the frontline of medical care and has direct exposure to complex clinical scenarios that exist outside the realm of the available evidence-base. According to a 2011 Institute of Medicine Committee Report, only 10–20 % of clinical decisions are evidence based [3]. Nearly 50 % of clinical practice guidelines rely on expert opinion rather than experimental data [4]. In this ‘data desert’ it is the role of the clinician to identify novel research questions important for direct clinical care [5]. These questions lend themselves naturally to the isolation of an exposure of interest.

Once a clinical question and exposure of interest have been identified, the clinician and data scientist will need to set about isolating a patient cohort. Phenotype querying of structured and unstructured data can be complex and requires frequent tuning of the search criteria. Often multiple, complementary queries are required in order to isolate the specific group of interest. In addition, the research team must consider patient ‘uniqueness’ in that some patients have multiple ICU admissions both during a single hospitalization and over repeat hospital visits. If the same patient is included more than once in a study cohort, the assumption of independent measures is lost.

Researchers must pay attention to the necessity to exclude some patients on the grounds of their background medical history or pathological status, such as pregnancy for example. Failing to do so could introduce confounders and corrupt the causal relationship of interest.

In one example from a published MIMIC-II study, the investigators attempted to determine whether proton pump inhibitor (PPI) use was associated with hypomagnesaemia in critically-ill patients in the ICU [6]. The exposure of interest in this study was ‘PPI use.’ A comparison group of patients who were exposed to an alternative acid-reducing agent (histamine-2 receptor antagonists) and a comparison group not receiving any acid reducing medications were identified. The outcome of interest was a low magnesium level. In order to isolate the study cohort in this case, queries had to be developed to identify:

1. First ICU admission for each patient
2. PPI use as identified through NLP analysis of the ‘Medication’ section of the admission History and Physical
3. Conditions likely to influence PPI use and/or magnesium levels (e.g. diarrheal illness, end-stage renal disease)
4. Patients who were transferred from other hospitals as medications received at other hospitals could not be accounted for (patients excluded)
5. Patients who did not have a magnesium level within 36-h of ICU admission (patients excluded)
6. Patients missing comorbidity data (patients excluded)
7. Potential confounders including diuretic use

The SQL queries corresponding to this example are provided under the name “SQL\_cohort\_selection”.

Maximizing the efficiency of data querying from EHRs is an area of active research and development. As an example, the Informatics for Integrating Biology and the Bedside (i2b2) network is an NIH funded program based at Partner’s Health Center (Boston, MA) that is developing a framework for simplifying data querying and extraction from EHRs. Software tools developed by i2b2 are free to download and promise to simplify the isolation of a clinical phenotype from raw EHR data <https://www.i2b2.org/about/index.html>. This and similar projects should help simplify the large number of queries necessary to develop a study cohort [7].

### ***10.2.4 Hidden Exposures***

Not all exposures of interest can be identified directly from data contained within EHRs. In these circumstances, investigators need to be creative in identifying recorded data points that track closely with the exposure of interest. Clinical reasoning in these circumstances is important.

For instance, a research team using the MIMIC II database selected ‘atrial fibrillation with rapid ventricular response receiving a rate control agent’ as the exposure of interest. Atrial fibrillation is a common tachyarrhythmia in critically-ill populations that has been associated with worse clinical outcomes. Atrial fibrillation with rapid ventricular response is often treated with one of three rate control agents: metoprolol, diltiazem, or amiodarone. Unfortunately, ‘atrial fibrillation with rapid ventricular response’ is not a structured variable in the EHR system connected to the MIMIC II database. Performing an NLP search for the term ‘atrial fibrillation with rapid ventricular response’ in provider notes and discharge summaries is feasible however would not provide the temporal resolution needed with respect to drug administration.

To overcome this obstacle, investigators generated an algorithm to indirectly identify the ‘hidden’ exposure. A query was developed to isolate the first dose of an intravenous rate control agent (metoprolol, diltiazem, or amiodarone) received by a unique patient in the ICU. Next, it was determined whether the heart rate of the patient within one-hour of recorded drug administration was  $>110$  beats per minute. Finally, an NLP algorithm was used to search the clinical chart for mention of atrial fibrillation. Those patients meeting all three conditions were included in the final study cohort. Examples of the Matlab code used to identify the cohort of interest is provided (function “Afib”), as well as Perl code for NLP (function “NLP”).

### ***10.2.5 Data Visualization***

Graphic representation of alphanumeric EHR data can be particularly helpful in establishing the study cohort. Data visualization makes EHR data more accessible and allows for the rapid identification of trends otherwise difficult to identify. It also promotes more effective communication both amongst research team members and between the research team and a general audience not accustomed to ‘Big Data’ investigation. These principles are discussed more extensively in Chap. 15 of this textbook “Exploratory Data Analysis”.

In the above mentioned project exploring the use of rate control agents for atrial fibrillation with rapid ventricular response, one outcome of interest was time until control of the rapid ventricular rate. Unfortunately, the existing literature does not provide specific guidance in this area. Using data visualization, a group consensus

was reached that rate control would be defined as a heart <110 for at least 90 % of the time over a 4-h period. Although some aspects of this definition are arbitrary, data visualization allowed for all team members to come to an agreement on what definition was the most statistically and clinically defensible.

### **10.2.6 Study Cohort Fidelity**

Query algorithms are generally unable to boast 100 % accuracy for identifying the sought patient phenotype. False positives and false negatives are expected. In order to guarantee the fidelity of the study cohort, manually reviewing a random subset of selected patients can be helpful. Based on the size of the study cohort, 5–10 % of clinical charts should be reviewed to ensure the presence or absence of the exposure of interest. This task should be accomplished by a clinician. If resources permit, two clinician reviewers can be tasked with this role and their independent results compared using a Kappa statistic.

Ultimately, the investigators can use the ‘gold standard’ of manual review to establish a Receiver Operating Characteristic (ROC). An area-under the ROC curve of >0.80 indicates ‘good’ accuracy of the algorithm and should be used as an absolute minimum of algorithm fidelity. If the area under the ROC curve is <0.80, a combination of data visualization techniques and clinical reasoning should be used to better tune the query algorithm to the exposure of interest.

## **10.3 PART 2—Case Study: Cohort Selection**

In the case study presented, the authors analyzed the effect of indwelling arterial catheters (IACs) in hemodynamically stable patients with respiratory failure using multivariate data. They identified the encounter-centric ‘arterial catheter placement’ as their exposure of interest. IACs are used extensively in the intensive care unit for beat-to-beat measuring of blood pressure and are thought to be more accurate and reliable than standard, non-invasive blood pressure monitoring. They also have the added benefit of allowing for simpler arterial blood gas collection which can reduce the need for repeated venous punctures. Given their invasive nature, however, IACs carry risks of bloodstream infection and vascular injury. The primary outcome of interest selected was 28-day mortality with secondary outcomes that included ICU and hospital length-of-stay, duration of mechanical ventilation, and mean number of blood gas measurements made.

The authors elected to focus their study on patients requiring mechanical ventilation that did not require vasopressor and were not admitted for sepsis. In patients

requiring mechanical ventilation, the dual role of IACs to allow for beat-to-beat blood pressure monitoring and to simplify arterial blood gas collection is thought to be particularly important. Patients with vasopressor requirements and/or sepsis were excluded as invasive arterial catheters are needed in this population to assist with the rapid titration of vasoactive agents. In addition, it would be difficult to identify enough patients requiring vasopressors or admitted for sepsis, who did not receive an IAC.

The authors began their cohort selection with all 24,581 patients included in the MIMIC II database. For patients with multiple ICU admissions, only the first ICU admission was used to ensure independence of measurements. The function “cohort1” contains the SQL query corresponding to this step. Next, the patients who required mechanical ventilation within the first 24-h of their ICU admission and received mechanical ventilation for at least 24-h stay were isolated (function “cohort2”). After identifying a cohort of patients requiring mechanical ventilation, the authors queried for placement of an IAC sited after initiation of mechanical ventilation (function “cohort3”). As a majority of patients in the cardiac surgery recovery unit had an IAC placed prior to ICU admission, all patients from the cardiac surgical ICU were excluded from the analysis (function “cohort4”). In order to exclude patients admitted to the ICU with sepsis, the authors utilized the Angus criteria (function “cohort5”). Finally, patients requiring vasopressors during their ICU admission were excluded (function “cohort6”).

The comparison group of patients who received mechanical ventilation for at least 24-h within the first 24-h of their ICU admission but did not have an IAC placed was identified. Ultimately, there were 984 patients in the group who received an IAC and 792 patients who did not. These groups were compared using propensity matching techniques described in the Chap. 23—“Propensity Score Analysis”.

Ultimately, this cohort consists of unique identifiers of patients meeting the inclusion criteria. Other researchers may be interested in accessing this particular cohort in order to replicate the study results or address a different research questions. The MIMIC website will in the future provide the possibility for investigators to share cohorts of patients, thus allowing research teams to interact and build upon other’s work.

### **Take Home Messages**

- Take time to characterize the exposure and outcomes of interest pre-hoc
- Utilize both structured and unstructured data to isolate your exposure and outcome of interest. NLP can be particularly helpful in analyzing unstructured data
- Data visualization can be very helpful in facilitating communication amongst team members

**Open Access** This chapter is distributed under the terms of the Creative Commons Attribution-NonCommercial 4.0 International License (<http://creativecommons.org/licenses/by-nc/4.0/>), which permits any noncommercial use, duplication, adaptation, distribution and reproduction in any medium or format, as long as you give appropriate credit to the original author(s) and the source, a link is provided to the Creative Commons license and any changes made are indicated.

The images or other third party material in this chapter are included in the work's Creative Commons license, unless indicated otherwise in the credit line; if such material is not included in the work's Creative Commons license and the respective action is not permitted by statutory regulation, users will need to obtain permission from the license holder to duplicate, adapt or reproduce the material.

## References

1. Hsu DJ, Feng M, Kothari R, Zhou H, Chen KP, Celi LA (2015) The association between indwelling arterial catheters and mortality in hemodynamically stable patients with respiratory failure: a propensity score analysis. *Chest* 148(6):1470–1476
2. Merkle K (2013) Defining patient populations using analytical tools: cohort builder and risk stratification. *Health Catalyst*, 21 Aug 2013
3. Institute of Medicine (US) Committee on Standards for Developing Trustworthy Clinical Practice Guidelines (2011) *Clinical practice guidelines we can trust*. National Academies Press (US), Washington (DC)
4. Committee on the Learning Health Care System in America and Institute of Medicine (2013) *Best care at lower cost: the path to continuously learning health care in America*. National Academies Press (US), Washington (DC)
5. Moskowitz A, McSparron J, Stone DJ, Celi LA (2015) Preparing a new generation of clinicians for the era of big data. *Harv Med Stud Rev* 2(1):24–27
6. Danziger J, William JH, Scott DJ, Lee J, Lehman L, Mark RG, Howell MD, Celi LA, Mukamal KJ (2013) Proton-pump inhibitor use is associated with low serum magnesium concentrations. *Kidney Int* 83(4):692–699
7. Jensen PB, Jensen LJ, Brunak S (2012) Mining electronic health records: towards better research applications and clinical care. *Nat Rev Genet* 13(6):395–405

# Chapter 11

## Data Preparation

Tom Pollard, Franck Deroncourt, Samuel Finlayson  
and Adrian Velasquez

### Learning Objectives

- Become familiar with common categories of medical data.
- Appreciate the importance of collaboration between caregivers and data analysts.
- Learn common terminology associated with relational databases and plain text data files.
- Understand the key concepts of reproducible research.
- Get practical experience in querying a medical database.

### 11.1 Introduction

Data is at the core of all research, so robust data management practices are important if studies are to be carried out efficiently and reliably. The same can be said for the management of the software used to process and analyze data. Ensuring good practices are in place at the beginning of a study is likely to result in significant savings further down the line in terms of time and effort [1, 2].

While there are well-recognized benefits in tools and practices such as version control, testing frameworks, and reproducible workflows, there is still a way to go before these become widely adopted in the academic community. In this chapter we discuss some key issues to consider when working with medical data and highlight some approaches that can make studies collaborative and reproducible.



## 11.2 Part 1—Theoretical Concepts

### 11.2.1 Categories of Hospital Data

Data is routinely collected from several different sources within hospitals, and is generally optimized to support clinical activities and billing rather than research. Categories of data commonly found in practice are summarized in Table 11.1 and discussed below:

- Billing data generally consists of the codes that hospitals and caregivers use to file claims with their insurance providers. The two most common coding systems are the International Statistical Classification of Diseases and Related

**Table 11.1** Overview of common categories of hospital data and common issues to consider during analysis

Category	Examples	Common issues to consider
Demographics	Age, gender, ethnicity, height, weight	Highly sensitive data requiring careful de-identification. Data quality in fields such as ethnicity may be poor
Laboratory	Creatinine, lactate, white blood cell count, microbiology results	Often no measure of sample quality. Methods and reagents used in tests may vary between units and across time
Radiographic images and associated reports	X-rays, computed tomography (CT) scans, echocardiograms	Protected health information, such as names, may be written on slides. Templates used to generate reports may influence content
Physiologic data	Vital signs, electrocardiography (ECG) waveforms, electroencephalography (EEG) waveforms	Data may be pre-processed by proprietary algorithms. Labels may be inaccurate (for example, “fingerstick glucose” measurements may be made with venous blood)
Medication	Prescriptions, dose, timing	May list medications that were ordered but not given. Time stamps may describe point of order not administration
Diagnosis and procedural codes	International Classification of Diseases (ICD) codes, Diagnosis Related Groups (DRG) codes, Current Procedural Terminology (CPT) codes	Often based on a retrospective review of notes and not intended to indicate a patient’s medical status. Subject to coder biases. Limited by suitability of codes
Caregiver and procedural notes	Admission notes, daily progress notes, discharge summaries, Operative reports	Typographical errors. Context is important (for example, diseases may appear in discussion of family history). Abbreviations and acronyms are common

Health Problems, commonly abbreviated the International Classification of Disease (ICD), which is maintained by the World Health Organization, and the Current Procedural Terminology (CPT) codes maintained by the American Medical Association. These hierarchical terminologies were designed to provide standardization for medical classification and reporting.

- Charted physiologic data, including information such as heart rate, blood pressure, and respiratory rate collected at the bedside. The frequency and breadth of monitoring is generally related to the level of care. Data is often archived at a lower rate than it is sampled (for example, every 5–10 min) using averaging algorithms which are frequently proprietary and undisclosed.
- Notes and reports, created to record patient progress, summaries a patient stay upon discharge, and provide findings from imaging studies such as x-rays and echocardiograms. While the fields are “free text”, notes are often created with the help of a templating system, meaning they may be partially structured.
- Images, such as those from x-rays, computerized axial tomography (CAT/CT) scans, echocardiograms, and magnetic resonance imaging.
- Medication and laboratory data. Orders for drugs and laboratory studies are entered by the caregiver into a physician order entry system, which are then fulfilled by laboratory or nursing staff. Depending on the system, some timestamps may refer to when the physician placed the order and others may refer to when the drug was administered or the lab results were reported. Some drugs may be administered days or weeks after first prescribed while some may not be administered at all.

### ***11.2.2 Context and Collaboration***

One of the greatest challenges of working with medical data is gaining knowledge of the context in which data is collected. For this reason we cannot emphasize enough the importance of collaboration between both hospital staff and research analysts. Some examples of common issues to consider when working with medical data are outlined in Table 11.1 and discussed below:

- Billing codes are not intended to document a patient’s medical status or treatment from a clinical perspective and so may not be reliable [3]. Coding practices may be influenced by issues such as financial compensation and associated paperwork, deliberately or otherwise.
- Timestamps may differ in meaning for different categories of data. For example, a timestamp may refer to the point when a measurement was made, when the measurement was entered into the system, when a sample was taken, or when results were returned by a laboratory.
- Abbreviations and misspelled words appear frequently in free text fields. The string “pad”, for example, may refer to either “peripheral artery disease” or to an

absorptive bed pad, or even a diaper pad. In addition, notes frequently mention diseases that are found in the patient's family history, but not necessarily the patient, so care must be taken when using simple text searches.

- Labels that describe concepts may not be accurate. For example, during preliminary investigations for an unpublished study to assess accuracy of fingertip glucose testing, it was discovered that caregivers would regularly take “fingerstick glucose” measurements using vascular blood where it was easily accessible, to avoid pricking the finger of a patient.

Each hospital brings its own biases to the data too. These biases may be tied to factors such as the patient populations served, the local practices of caregivers, or to the type of services provided. For example:

- Academic centers often see more complicated patients, and some hospitals may tend to serve patients of a specific ethnic background or socioeconomic status.
- Follow up visits may be less common at referral centers and so they may be less likely to detect long-term complications.
- Research centers may be more likely to place patients on experimental drugs not generally used in practice.

### ***11.2.3 Quantitative and Qualitative Data***

Data is often described as being either quantitative or qualitative. Quantitative data is data that can be measured, written down with numbers and manipulated numerically. Quantitative data can be discrete, taking only certain values (for example, the integers 1, 2, 3), or continuous, taking any value (for example, 1.23, 2.59). The number of times a patient is admitted to a hospital is discrete (a patient cannot be admitted 0.7 times), while a patient's weight is a continuous (a patient's weight could take any value within a range).

Qualitative data is information which cannot be expressed as a number and is often used interchangeably with the term “categorical” data. When there is not a natural ordering of the categories (for example, a patient's ethnicity), the data is called nominal. When the categories can be ordered, these are called ordinal variables (for example, severity of pain on a scale). Each of the possible values of a categorical variable is commonly referred to as a level.

### ***11.2.4 Data Files and Databases***

Data is typically made available through a database or as a file which may have been exported from a database. While there are many different kinds of databases and data files in use, relational databases and comma separated value (CSV) files are perhaps the most common.

### Comma Separated Value (CSV) Files

Comma separated value (CSV) files are a plain text format used for storing data in a tabular, spreadsheet-style structure. While there is no hard and fast rule for structuring tabular data, it is usually considered good practice to include a header row, to list each variable in a separate column, and to list observations in rows [4].

As there is no official standard for the CSV format, the term is used somewhat loosely, which can often cause issues when seeking to load the data into a data analysis package. A general recommendation is to follow the definition for CSVs set out by the Internet Engineering Task Force in the RFC 4180 specification document [5]. Summarized briefly, RFC 4180 specifies that:

- files may optionally begin with a header row, with each field separated by a comma;
- Records should be listed in subsequent rows. Fields should be separated by commas, and each row should be terminated with a line break;
- fields that contain numbers may be optionally enclosed within double quotes;
- fields that contain text (“strings”) should be enclosed within double quotes;
- If a double quote appears inside a string of text then it must be escaped with a preceding double quote.

The CSV format is popular largely because of its simplicity and versatility. CSV files can be edited with a text editor, loaded as a spreadsheet in packages such as Microsoft Excel, and imported and processed by most data analysis packages. Often CSV files are an intermediate data format used to hold data that has been extracted from a relational database in preparation for analysis. Figure 11.1 shows an annotated example of a CSV file formatted to the RFC 4180 specification.

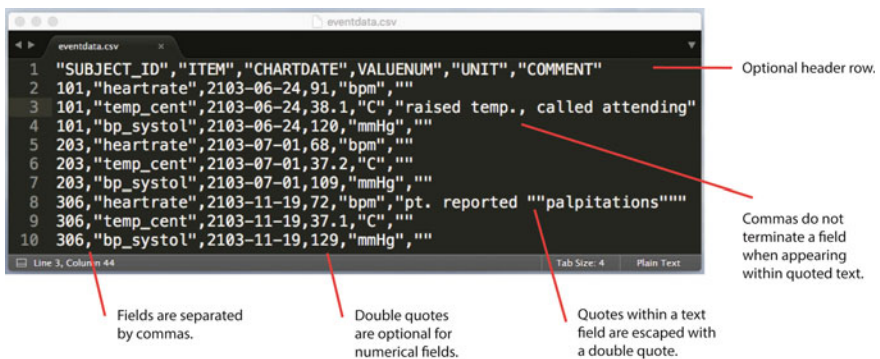
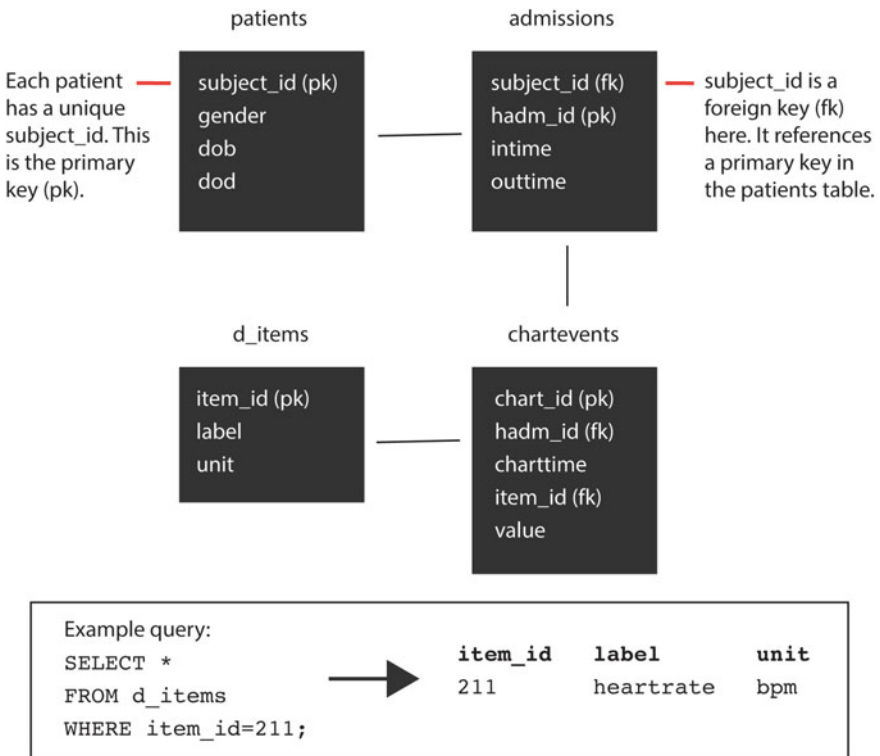


Fig. 11.1 Comma separated value (CSV) file formatted to the RFC 4180 specification

### Relational Databases

There are several styles of database in use today, but probably the most widely implemented is the “relational database”. Relational databases can be thought of as a collection of tables which are linked together by shared keys. Organizing data across tables can help to maintain data integrity and enable faster analysis and more efficient storage.

The model that defines the structure and relationships of the tables is known as a “database schema”. Giving a simple example of a hospital database with four tables, it might comprise of: Table 1, a list of all patients; Table 2, a log of hospital admissions; Table 3, a list of vital sign measurements; Table 4, a dictionary of vital sign codes and associated labels. Figure 11.2 demonstrates how these tables can be linked with primary and foreign keys. Briefly, a primary key is a unique identifier within a table. For example, `subject_id` is the primary key in the `patients` table,



**Fig. 11.2** Relational databases consist of multiple data tables linked by primary and foreign keys. The `patients` table lists unique patients. The `admissions` table lists unique hospital admissions. The `chartevents` table lists charted events such as heart rate measurements. The `d_items` table is a dictionary that lists `item_ids` and associated labels, as shown in the example query. *pk* is primary key. *fk* is foreign key

because each patient is listed only once. A foreign key in one table points to a primary key in another table. For example, `subject_id` in the `admissions` table is a foreign key, because it references the primary key in the `patients` table.

Extracting data from a database is known as “querying” the database. The programming language commonly used to create a query is known as “Structured Query Language” or SQL. While the syntax of SQL is straightforward, queries are at times challenging to construct as a result of the conceptual reasoning required to join data across multiple tables.

There are many different relational database systems in regular use. Some of these systems such as Oracle Database and Microsoft SQL Server are proprietary and may have licensing costs. Other systems such as PostgreSQL and MySQL are open source and free to install. The general principle behind the databases is the same, but it is helpful to be aware that programming syntax varies slightly between systems.

### ***11.2.5 Reproducibility***

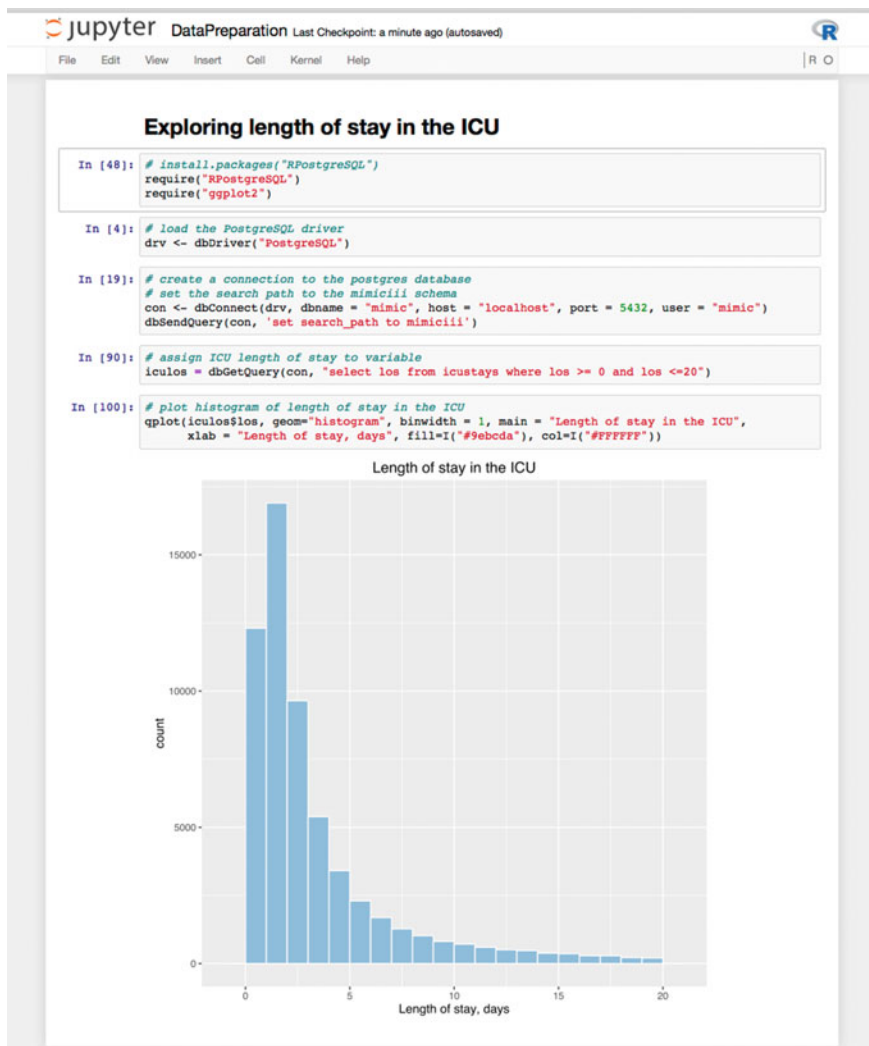
Alongside a publishing system that emphasizes interpretation of results over detailed methodology, researchers are under pressure to deliver regular “high-impact” papers in order to sustain their careers. This environment may be a contributor to the widely reported “reproducibility crisis” in science today [6, 7].

Our response should be to ensure that studies are, as far as possible, reproducible. By making data and code accessible, we can more easily detect and fix inevitable errors, help each other to learn from our methods, and promote better quality research.

When practicing reproducible research, the source data should not be modified. Editing the raw data destroys the chain of reproducibility. Instead, code is used to process the data so that all of the steps that take an analysis from source to outcome can be reproduced.

Code and data should be well documented and the terms of reuse should be made clear. It is typical to provide a plain text “README” file that gives an introduction to the analysis package, along with a “LICENSE” file describing the terms of reuse. Tools such as Jupyter Notebook, Sweave, and Knitr can be used to interweave code and text to produce clearly documented, reproducible studies, and are becoming increasingly popular in the research community (Fig. 11.3).

Version control systems such as Git can be used to track the changes made to code over time and are also becoming an increasingly popular tool for researchers [8]. When working with a version control system, a commit log provides a record of changes to code by contributor, providing transparency in the development process and acting as a useful tool for uncovering and fixing bugs.



**Fig. 11.3** Jupyter Notebooks enable documentation and code to be combined into a reproducible analysis. In this example, the length of ICU stay is loaded from the MIMIC-III (v1.3) database and plotted as a histogram [11]

Collaboration is also facilitated by version control systems. Git provides powerful functionality that facilitates distribution of code and allows multiple people to work together in synchrony. Integration with Git hosting services such as Github provide a simple mechanism for backing up content, helping to reduce the risk of data loss, and also provide tools for tracking issues and tasks [8, 9].

## 11.3 Part 2—Practical Examples of Data Preparation

### 11.3.1 MIMIC Tables

In order to carry out the study on the effect of indwelling arterial catheters as described in the previous chapter, we use the following tables in the MIMIC-III clinical database:

- The `chartevents` table, the largest table in the database. It contains all data charted by the bedside critical care system, including physiological measurements such as heart rate and blood pressure, as well as the settings used by the indwelling arterial catheters.
- The `patients` table, which contains the demographic details of each patient admitted to an intensive care unit, such as gender, date of birth, and date of death.
- The `icustays` table, which contains administrative details relating to stays in the ICU, such as the admission time, discharge time, and type of care unit.

Before continuing with the following exercises, we recommend familiarizing yourself with the MIMIC documentation and in particular the table descriptions, which are available on the MIMIC website [10].

### 11.3.2 SQL Basics

An SQL query has the following format:

```
SELECT [columns]
FROM [table_name]
WHERE [conditions];
```

The result returned by the query is a list of rows. The following query lists the unique patient identifiers (`subject_ids`) of all female patients:

```
SELECT subject_id
FROM patients
WHERE gender = 'F';

-- returns:
subject_id
-----
        654
        655
        656
        ...
```



We often need to specify more than one condition. For instance, the following query lists the `subject_ids` whose first or last care unit was a coronary care unit (CCU):

```
SELECT subject_id
FROM icustays
WHERE first_careunit = 'CCU' OR last_careunit = 'CCU';

-- returns:
  subject_id
-----
         109
         109
         111
         ...
```

Since a patient may have been in several ICUs, the same patient ID sometimes appears several times in the result of the previous query. To return only distinct rows, use the `DISTINCT` keyword:

```
SELECT DISTINCT subject_id
FROM icustays
WHERE first_careunit = 'CCU' OR last_careunit = 'CCU';

-- returns:
  subject_id
-----
       25949
        6158
       27223
        ...
```

To count how many patients there are in the `icustays` table, combine `DISTINCT` with the `COUNT` keyword. As you can see, if there is no condition, we simply don't use the keyword `WHERE`:

```
SELECT COUNT(DISTINCT subject_id)
FROM icustays;

-- returns:
  count
-----
  46476
```

Taking a similar approach, we can count how many patients went through the CCU using the query:

```
SELECT COUNT(DISTINCT subject_id)
FROM icustays
WHERE first_careunit = 'CCU' OR last_careunit = 'CCU';

-- returns:
count
-----
  7314
```

The operator `*` is used to display all columns. The following query displays the entire `icustays` table:

```
SELECT *
FROM icustays;

-- returns
subject_id | hadm_id | icustay_id | ...
          109 | 139061 | 257358 | ...
          109 | 172335 | 262652 | ...
          109 | 126055 | 236124 | ...
...

```

The results can be sorted based on one or several columns with `ORDER BY`. To add a comment in a SQL query, use:

```
SELECT subject_id, hadm_id, icustay_id
FROM icustays
ORDER BY subject_id ASC; -- ASC sorts by ascending number

-- returns:
subject_id | hadm_id | icustay_id
-----+-----+-----
          2 | 163353 | 243653
          3 | 145834 | 211552
          4 | 185777 | 294638
...

```

### 11.3.3 Joins

Often we need information coming from multiple tables. This can be achieved using SQL joins. There are several types of join, including **INNER JOIN**, **OUTER JOIN**, **LEFT JOIN**, and **RIGHT JOIN**. It is important to understand the difference between these joins because their usage can significantly impact query results. Detailed guidance on joins is widely available on the web, so we will not go into further details here. We will however provide an example of an **INNER JOIN** which selects all rows where the joined key appears in both tables.

Using the **INNER JOIN** keyword, let's count how many adult patients went through the coronary care unit. To know whether a patient is an adult, we need to use the **dob** (date of birth) attribute from the **patients** table. We can use the **INNER JOIN** to indicate that two or more tables should be combined based on a common attribute, which in our case is **subject\_id**:

```
-- INNER JOIN will only return rows where subject_id
-- appears in the patients table and the icustays table
SELECT p.subject_id
FROM patients p
INNER JOIN icustays i
ON p.subject_id = i.subject_id
WHERE (i.first_careunit = 'CCU' OR i.last_careunit = 'CCU')
      AND (i.intime - p.dob) >= INTERVAL '18' year
ORDER BY subject_id ASC;

-- returns:
subject_id
-----
          13
          18
          21
          ...
```

Note that:

- we assign an alias to a table to avoid writing its full name throughout the query. In our 0 given the alias 'p'.
- in the **SELECT** clause, we wrote **p.subject\_id** instead of simply **subject\_id** since both the **patients** and **icustays** tables contain the attribute **subject\_id**. If we don't specify from which table **subject\_id** comes from, we would get a "column ambiguously defined" error.
- to identify whether a patient is an adult, we look for differences between **intime** and **dob** of 18 years or greater using the **INTERVAL** keyword.

### 11.3.4 Ranking Across Rows Using a Window Function

We now focus on the case study. One of the first steps is identifying the first ICU admission for each patient. To do so, we can use the `RANK ()` function to order rows sequentially by `intime`. Using the `PARTITION BY` expression allows us to perform the ranking across `subject_id` windows:

```
SELECT subject_id, icustay_id, intime,
       RANK() OVER (PARTITION BY subject_id ORDER BY intime asc)
FROM icustays;
```

-- returns:

subject_id	icustay_id	intime	rank
6	228232	2175-05-30 21:30:54	1
7	278444	2121-05-23 15:35:29	1
7	236754	2121-05-25 03:26:01	2
...			

### 11.3.5 Making Queries More Manageable Using WITH

To keep SQL queries reasonably short and simple, we can use the `WITH` keyword. `WITH` allows us to break a large query into smaller, more manageable chunks. The following query creates a temporary table called “rankedstays” that lists the order of stays for each patient. We then select only the rows in this table where the rank is equal to one (i.e. the first stay) and the patient is aged 18 years or greater:

```
WITH rankedstays AS (
  SELECT subject_id, icustay_id, intime,
         RANK() OVER (PARTITION BY subject_id ORDER BY intime asc)
  FROM icustays
)
```

```
SELECT r.subject_id, r.icustay_id, r.intime, r.rank
FROM rankedstays r
INNER JOIN patients p
ON r.subject_id = p.subject_id
WHERE r.rank = 1
AND (r.intime - p.dob) >= INTERVAL '18' year;
```

-- returns:

subject_id	icustay_id	intime	rank
3	211552	2101-10-20 19:10:11	1
4	294638	2191-03-16 00:29:31	1
6	228232	2175-05-30 21:30:54	1
...			

**Open Access** This chapter is distributed under the terms of the Creative Commons Attribution-NonCommercial 4.0 International License (<http://creativecommons.org/licenses/by-nc/4.0/>), which permits any noncommercial use, duplication, adaptation, distribution and reproduction in any medium or format, as long as you give appropriate credit to the original author(s) and the source, a link is provided to the Creative Commons license and any changes made are indicated.

The images or other third party material in this chapter are included in the work's Creative Commons license, unless indicated otherwise in the credit line; if such material is not included in the work's Creative Commons license and the respective action is not permitted by statutory regulation, users will need to obtain permission from the license holder to duplicate, adapt or reproduce the material.

## References

1. Wilson G, Aruliah DA, Brown CT, Chue Hong NP, Davis M, Guy RT et al (2014) Best practices for scientific computing. *PLoS Biol* 12(1):e1001745. doi:10.1371/journal.pbio.1001745. <http://journals.plos.org/plosbiology/article?id=10.1371/journal.pbio.1001745>
2. Editorial (2012) Must try harder. *Nature* 483(509). doi:10.1038/483509a. <http://www.nature.com/nature/journal/v483/n7391/full/483509a.html>
3. Misset B, Nakache D, Vesin A, Darmon M, Garrouste-Orgeas M, Mourvillier B et al (2008) Reliability of diagnostic coding in intensive care patients. *Crit Care* 12(4):R95. <http://www.ncbi.nlm.nih.gov/pmc/articles/PMC2575581/>
4. Wickham H (2014) Tidy data. *J Stat Softw* 59(10):1–23. doi:10.18637/jss.v059.i10. <https://www.jstatsoft.org/article/view/v059i10>
5. Sustainability of Digital Formats Planning for Library of Congress Collections. Accessed: 24 Feb 2016. CSV, Comma Separated Values (RFC 4180). <http://www.digitalpreservation.gov/formats/fdd/fdd000323.shtml>
6. Editorial (2013) Unreliable research: trouble at the Lab. *Economist*. <http://www.economist.com/news/briefing/21588057-scientists-think-science-self-correcting-alarming-degree-it-not-trouble>
7. Goodman A, Pepe A, Blocker AW, Borgman CL, Cranmer K, Crosas M, et al (2014) Ten simple rules for the care and feeding of scientific data. *PLoS Comput Biol* 10(4):e1003542. doi:10.1371/journal.pcbi.1003542. <http://journals.plos.org/ploscompbiol/article?id=10.1371/journal.pcbi.1003542>
8. Karthik R (2013) Git can facilitate greater reproducibility and increased transparency in science. *Source Code Biol Med* 28; 8(1):7. doi:10.1186/1751-0473-8-7. <http://scfbm.biomedcentral.com/articles/10.1186/1751-0473-8-7>
9. GitHub. <https://github.com>. Accessed 24 Feb 2016
10. MIMIC website. <http://mimic.physionet.org>. Accessed 24 Feb 2016
11. MIMIC Code Repository. <https://github.com/MIT-LCP/mimic-code>. Accessed 24 Feb 2016

# Chapter 12

## Data Pre-processing

Brian Malley, Daniele Ramazzotti and Joy Tzung-yu Wu

### Learning Objectives

- Understand the requirements for a “clean” database that is “tidy” and ready for use in statistical analysis.
- Understand the steps of cleaning raw data, integrating data, reducing and reshaping data.
- Be able to apply basic techniques for dealing with common problems with raw data including missing data inconsistent data, and data from multiple sources.

### 12.1 Introduction

Data pre-processing consists of a series of steps to transform raw data derived from data extraction (see Chap. 11) into a “clean” and “tidy” dataset prior to statistical analysis. Research using electronic health records (EHR) often involves the secondary analysis of health records that were collected for clinical and billing (non-study) purposes and placed in a study database via automated processes. Therefore, these databases can have many quality control issues. Pre-processing aims at assessing and improving the quality of data to allow for reliable statistical analysis.

Several distinct steps are involved in pre-processing data. Here are the general steps taken to pre-process data [1]:

- Data “cleaning”—This step deals with missing data, noise, outliers, and duplicate or incorrect records while minimizing introduction of bias into the database. These methods are explored in detail in Chaps. 13 and 14.
- “Data integration”—Extracted raw data can come from heterogeneous sources or be in separate datasets. This step reorganizes the various raw datasets into a single dataset that contain all the information required for the desired statistical analyses.

- “Data transformation”—This step translates and/or scales variables stored in a variety of formats or units in the raw data into formats or units that are more useful for the statistical methods that the researcher wants to use.
- “Data reduction”—After the dataset has been integrated and transformed, this step removes redundant records and variables, as well as reorganizes the data in an efficient and “tidy” manner for analysis.

Pre-processing is sometimes iterative and may involve repeating this series of steps until the data are satisfactorily organized for the purpose of statistical analysis. During pre-processing, one needs to take care not to accidentally introduce bias by modifying the dataset in ways that will impact the outcome of statistical analyses. Similarly, we must avoid reaching statistically significant results through “trial and error” analyses on differently pre-processed versions of a dataset.

## 12.2 Part 1—Theoretical Concepts

### 12.2.1 *Data Cleaning*

Real world data are usually “messy” in the sense that they can be incomplete (e.g. missing data), they can be noisy (e.g. random error or outlier values that deviate from the expected baseline), and they can be inconsistent (e.g. patient age 21 and admission service is neonatal intensive care unit).

The reasons for this are multiple. Missing data can be due to random technical issues with biomonitors, reliance on human data entry, or because some clinical variables are not consistently collected since EHR data were collected for non-study purposes. Similarly, noisy data can be due to faults or technological limitations of instruments during data gathering (e.g. dampening of blood pressure values measured through an arterial line), or because of human error in entry. All the above can also lead to inconsistencies in the data. Bottom line, all of these reasons create the need for meticulous data cleaning steps prior to analysis.

#### *Missing Data*

A more detailed discussion regarding missing data will be presented in Chap. 13. Here, we describe three possible ways to deal with missing data [1]:

- Ignore the record. This method is not very effective, unless the record (observation/row) contains several variables with missing values. This approach is especially problematic when the percentage of missing values per variable varies considerably or when there is a pattern of missing data related to an unrecognized underlying cause such as patient condition on admission.

- Determine and fill in the missing value manually. In general, this approach is the most accurate but it is also time-consuming and often is not feasible in a large dataset with many missing values.
- Use an expected value. The missing values can be filled in with predicted values (e.g. using the mean of the available data or some prediction method). It must be underlined that this approach may introduce bias in the data, as the inserted values may be wrong. This method is also useful for comparing and checking the validity of results obtained by ignoring missing records.

### ***Noisy Data***

We term noise a random error or variance in an observed variable—a common problem for secondary analyses of EHR data. For example, it is not uncommon for hospitalized patients to have a vital sign or laboratory value far outside of normal parameters due to inadequate (hemolyzed) blood samples, or monitoring leads disconnected by patient movement. Clinicians are often aware of the source of error and can repeat the measurement then ignore the known incorrect outlier value when planning care. However, clinicians cannot remove the erroneous measurement from the medical record in many cases, so it will be captured in the database. A detailed discussion on how to deal with noisy data and outliers is provided in Chap. 14; for now we limit the discussion to some basic guidelines [1].

- Binning methods. Binning methods smooth a sorted data value by considering their ‘neighborhood’, or values around it. These kinds of approaches to reduce noise, which only consider the neighborhood values, are said to be performing local smoothing.
- Clustering. Outliers may be detected by clustering, that is by grouping a set of values in such a way that the ones in the same group (i.e., in the same cluster) are more similar to each other than to those in other groups.
- Machine learning. Data can be smoothed by means of various machine learning approaches. One of the classical methods is the regression analysis, where data are fitted to a specified (often linear) function.

Same as for missing data, human supervision during the process of noise smoothing or outliers detection can be effective but also time-consuming.

### ***Inconsistent Data***

There may be inconsistencies or duplications in the data. Some of them may be corrected manually using external references. This is the case, for instance, of errors made at data entry. Knowledge engineering tools may also be used to detect the violation of known data constraints. For example, known functional dependencies among attributes can be used to find values contradicting the functional constraints.



Inconsistencies in EHR result from information being entered into the database by thousands of individual clinicians and hospital staff members, as well as captured from a variety of automated interfaces between the EHR and everything from telemetry monitors to the hospital laboratory. The same information is often entered in different formats by these different sources.

Take, for example, the intravenous administration of 1 g of the antibiotic vancomycin contained in 250 mL of dextrose solution. This single event may be captured in the dataset in several different ways. For one patient this event may be captured from the medication order as the code number (ITEMID in MIMIC) from the formulary for the antibiotic vancomycin with a separate column capturing the dose stored as a numerical variable. However, on another patient the same event could be found in the fluid intake and output records under the code for the IV dextrose solution with an associated free text entered by the provider. This text would be captured in the EHR as, for example “vancomycin 1 g in 250 ml”, saved as a text variable (string, array of characters, etc.) with the possibility of spelling errors or use of nonstandard abbreviations. Clinically these are the exact same event, but in the EHR and hence in the raw data, they are represented differently. This can lead to the same single clinical event not being captured in the study dataset, being captured incorrectly as a different event, or being captured multiple times for a single occurrence.

In order to produce an accurate dataset for analysis, the goal is for each patient to have the same event represented in the same manner for analysis. As such, dealing with inconsistency perfectly would usually have to happen at the data entry or data extraction level. However, as data extraction is imperfect, pre-processing becomes important. Often, correcting for these inconsistencies involves some understanding of how the data of interest would have been captured in the clinical setting and where the data would be stored in the EHR database.

### ***12.2.2 Data Integration***

Data integration is the process of combining data derived from various data sources (such as databases, flat files, etc.) into a consistent dataset. There are a number of issues to consider during data integration related mostly to possible different standards among data sources. For example, certain variables can be referred by means of different IDs in two or more sources.

In the MIMIC database this mainly becomes an issue when some information is entered into the EHR during a different phase in the patient’s care pathway, such as before admission in the emergency department, or from outside records. For example, a patient may have laboratory values taken in the ER before they are

admitted to the ICU. In order to have a complete dataset it will be necessary to integrate the patient's full set of lab values (including those not associated with the same MIMIC ICUSTAY identifier) with the record of that ICU admission without repeating or missing records. Using shared values between datasets (such as a hospital stay identifier or a timestamp in this example) can allow for this to be done accurately.

Once data cleaning and data integration are completed, we obtain one dataset where entries are reliable.

### ***12.2.3 Data Transformation***

There are many possible transformations one might wish to do to raw data values depending on the requirement of the specific statistical analysis planned for a study. The aim is to transform the data values into a format, scale or unit that is more suitable for analysis (e.g. log transform for linear regression modeling). Here are few common possible options:

#### ***Normalization***

This generally means data for a numerical variable are scaled in order to range between a specified set of values, such as 0–1. For example, scaling each patient's severity of illness score to between 0 and 1 using the known range of that score in order to compare between patients in a multiple regression analysis.

#### ***Aggregation***

Two or more values of the same attribute are aggregated into one value. A common example is the transformation of categorical variables where multiple categories can be aggregated into one. One example in MIMIC is to define all surgical patients by assigning a new binary variable to all patients with an ICU service noted to be "SICU" (surgical ICU) or "CSRU" (cardiac surgery ICU).

#### ***Generalization***

Similar to aggregation, in this case low level attributes are transformed into higher level ones. For example, in the analysis of chronic kidney disease (CKD) patients, instead of using a continuous numerical variable like the patient's creatinine levels, one could use a variable for CKD stages as defined by accepted guidelines.

### 12.2.4 Data Reduction

Complex analysis on large datasets may take a very long time or even be infeasible. The final step of data pre-processing is data reduction, i.e., the process of reducing the input data by means of a more effective representation of the dataset without compromising the integrity of the original data. The objective of this step is to provide a version of the dataset on which the subsequent statistical analysis will be more effective. Data reduction may or may not be lossless. That is the end database may contain all the information of the original database in more efficient format (such as removing redundant records) or it may be that data integrity is maintained but some information is lost when data is transformed and then only represented in the new form (such as multiple values being represented as an average value).

One common MIMIC database example is collapsing the ICD9 codes into broad clinical categories or variables of interest and assigning patients to them. This reduces the dataset from having multiple entries of ICD9 codes, in text format, for a given patient, to having a single entry of a binary variable for an area of interest to the study, such as history of coronary artery disease. Another example would be in the case of using blood pressure as a variable in analysis. An ICU patient will generally have their systolic and diastolic blood pressure monitored continuously via an arterial line or recorded multiple times per hour by an automated blood pressure cuff. This results in hundreds of data points for each of possibly thousands of study patients. Depending on the study aims, it may be necessary to calculate a new variable such as average mean arterial pressure during the first day of ICU admission.

Lastly, as part of more effective organization of datasets, one would also aim to reshape the columns and rows of a dataset so that it conforms with the following 3 rules of a “tidy” dataset [2, 3]:

1. Each variable forms a column
2. Each observation forms a row
3. Each value has its own cell

“Tidy” datasets have the advantage of being more easily visualized and manipulated for later statistical analysis. Datasets exported from MIMIC usually are fairly “tidy” already; therefore, rule 2 is hardly ever broken. However, sometimes there may still be several categorical values within a column even for MIMIC datasets, which breaks rule 1. For example, multiple categories of marital status or ethnicity under the same column. For some analyses, it is useful to split each categorical values of a variable into their own columns. Fortunately though, we do not often have to worry about breaking rule 3 for MIMIC data as there are not often multiple values in a cell. These concepts will become clearer after the MIMIC examples in Sect. 12.3

## 12.3 PART 2—Examples of Data Pre-processing in R

There are many tools for doing data pre-processing available, such as R, STATA, SAS, and Python; each differs in the level of programming background required. R is a free tool that is supported by a range of statistical and data manipulation packages. In this section of the chapter, we will go through some examples demonstrating various steps of data pre-processing in R, using data from various MIMIC dataset (SQL extraction codes included). Due to the significant content involved with the data cleaning step of pre-processing, this step will be separately addressed in Chaps. 13 and 14. The examples in this section will deal with some R basics as well as data integration, transformation, and reduction.

### 12.3.1 R—The Basics

The most common data output from a MIMIC database query is in the form of ‘comma separated values’ files, with filenames ending in ‘.csv’. This output file format can be selected when exporting the SQL query results from MIMIC database. Besides ‘.csv’ files, R is also able to read in other file formats, such as Excel, SAS, etc., but we will not go into the detail here.

#### *Understanding ‘Data Types’ in R*

For many who have used other data analysis software or who have a programming background, you will be familiar with the concept of ‘data types’.

R strictly stores data in several different data types, called ‘classes’:

- Numeric – e.g. 3.1415, 1.618
- Integer – e.g. -1, 0, 1, 2, 3
- Character – e.g. “vancomycin”, “metronidazole”
- Logical – TRUE, FALSE
- Factors/categorical – e.g. male or female under variable, gender

R also usually does not allow mixing of data types for a variable, except in a:

- List – as a one dimensional vector, e.g. c(“vancomycin”, 1.618, “red”)
- Data-frame – as a two dimensional table with rows (observations) and columns (variables)

Lists and data-frames are treated as their own ‘class’ in R.

Query output from MIMIC commonly will be in the form of data tables with different data types in different columns. Therefore, R usually stores these tables as ‘data-frames’ when they are read into R.

### *Special Values in R*

- NA – ‘not available’, usually a default placeholder for missing values.
- NAN – ‘not a number’, only applying to numeric vectors.
- NULL – ‘empty’ value or set. Often returned by expressions where the value is undefined.
- Inf – value for ‘infinity’ and only applies to numeric vectors.

### *Setting Working Directory*

This step tells R where to read in the source files.

Command: `setwd("directory_path")`

Example: (If all data files are saved in directory “MIMIC\_data\_files” on the Desktop)

```
setwd("~/Desktop/MIMIC_data_files")

# List files in directory:
list.files()
## [1] "c_score_sicker.csv"          "comorbidity_scores.csv"
## [3] "demographics.csv"          "mean_arterial_pressure.csv"
## [5] "population.csv"
```

### *Reading in .csv Files from MIMIC Query Results*

The data read into R is assigned a ‘name’ for reference later on.

Command: `set_var_name <- read.csv("filename.csv")`

**Example:**

```
demo <- read.csv("demographics.csv")
```

**Viewing the Dataset**

There are several commands in R that are very useful for getting a ‘feel’ of your datasets and see what they look like before you start manipulating them.

- View the first and last 2 rows. E.g.:

```
head(demo, 2)

##  subject_id hadm_id marital_status_descr ethnicity_descr
## 1           4  17296                SINGLE             WHITE
## 2           6  23467                MARRIED             WHITE

tail(demo, 2)

##      subject_id hadm_id marital_status_descr ethnicity_descr
## 27624      32807  32736                MARRIED UNABLE TO OBTAIN
## 27625      32805  34884                DIVORCED             WHITE
```

- View summary statistics. E.g.:

```
summary(demo)

##      subject_id      hadm_id      marital_status_descr
##  Min.   : 3      Min.   : 1      MARRIED   :13447
##  1st Qu.: 8063    1st Qu.: 9204    SINGLE    : 6412
##  Median :16060    Median :18278    WIDOWED  : 4029
##  Mean   :16112    Mean   :18035    DIVORCED : 1623
##  3rd Qu.:24119    3rd Qu.:26762           : 1552
##  Max.   :32809    Max.   :36118    SEPARATED: 320
##                                     (Other)  : 242
##
##      ethnicity_descr
##  WHITE                :19360
##  UNKNOWN/NOT SPECIFIED : 3446
##  BLACK/AFRICAN AMERICAN: 2251
##  ...
```

- View structure of data set (obs = number of rows). E.g.:

```
str(demo)

## 'data.frame':  27625 obs. of  4 variables:
## $ subject_id      : int  4 6 3 9 15 14 11 18 18 19 ...
## $ hadm_id         : int 17296 23467 2075 8253 4819 23919 28128
24759 33481 25788 ...
## $ marital_status_descr: Factor w/  8 levels "", "DIVORCED",...: 6 4 4
1 6 4 4 4 4 1 ...
## $ ethnicity_descr  : Factor w/ 39 levels "AMERICAN INDIAN/ALASKA
NATIVE",...: 35 35 35 34 12 35 35 35 35 35 ...
```

- Find out the ‘class’ of a variable or dataset. E.g.:

```
class(demo)

## [1] "data.frame"
```

- View number of rows and column, or alternatively, the dimension of the dataset. E.g.:

```
nrow(demo)

## [1] 27625

ncol(demo)

## [1] 4

dim(demo)

## [1] 27625  4
```

- Calculate length of a variable. E.g.:

```
x <- c(1:10); x

## [1]  1  2  3  4  5  6  7  8  9 10

class(x)

## [1] "integer"
```

### *Subsetting a Dataset and Adding New Variables/Columns*

**Aim:** Sometimes, it may be useful to look at only some columns or some rows in a dataset/data-frame—this is called subsetting.

Let's create a simple data-frame to demonstrate basic subsetting and other command functions in R. One simple way to do this is to create each column of the data-frame separately then combine them into a dataframe later. Note the different kinds of data types for the columns/variables created, and beware that R is case-sensitive.

**Examples:** Note that comments appearing after the hash sign (#) will not be evaluated.

```

subject_id <- c(1:6)                                     #integer
gender <- as.factor(c("F", "F", "M", "F", "M", "M"))#factor/categorical
height <- c(1.52, 1.65, 1.75, 1.72, 1.85, 1.78)        #numeric
weight <- c(56.7, 99.6, 90.4, 85.3, 71.4, 130.5)       #numeric
data <- data.frame(subject_id, gender, height, weight)

head(data, 4)                                           # View only the first 4 rows

##  subject_id gender height weight
## 1           1     F   1.52   56.7
## 2           2     F   1.65   99.6
## 3           3     M   1.75   90.4
## ...

str(data)                                               # Note the class of each variable/column

## 'data.frame':   6 obs. of  4 variables:
## $ subject_id: int  1 2 3 4 5 6
## $ gender    : Factor w/ 2 levels "F","M": 1 1 2 1 2 2
## $ height    : num  1.52 1.65 1.75 1.72 1.85 1.78
## $ weight    : num  56.7 99.6 90.4 85.3 71.4 ...

```

To subset or extract only e.g., weight, we can use either the dollar sign (\$) after the dataset, data, or use the square brackets, []. The \$ selects column with the column name (without quotation mark in this case). The square brackets [] here selected the column weight by its column number:



```
w1 <- data$weight; w1
## [1] 56.7 99.6 90.4 85.3 71.4 130.5
w2 <- data[, 4]; w2
## [1] 56.7 99.6 90.4 85.3 71.4 130.5
```

Generally one can subset a dataset by specifying the rows and column desired like this: `data[row number, column number]`. For example:

```
dat_sub <- data[2:4, 1:3]; dat_sub
##  subject_id gender height
## 2          2      F  1.65
## 3          3      M  1.75
## 4          4      F  1.72
```

The square brackets are useful for subsetting multiple columns or rows. Note that it is important to ‘concatenate’, `c()`, if selecting multiple variables/columns and to use quotation marks when selecting with columns names

```
h_w1 <- data[, c(3, 4)]; h_w1
##  height weight
## 1  1.52  56.7
## 2  1.65  99.6
## 3  1.75  90.4
## ...
h_w2 <- data[, c("height", "weight")]; h_w2
##  height weight
## 1  1.52  56.7
## 2  1.65  99.6
## 3  1.75  90.4
## ...
```

To calculate the BMI ( $\text{weight}/\text{height}^2$ ) in a new column—there are different ways to do this but here is a simple method:

```
data$BMI <- data$weight/data$height^2
head(data, 4)

##  subject_id gender height weight      BMI
## 1           1     F   1.52   56.7 24.54120
## 2           2     F   1.65   99.6 36.58402
## 3           3     M   1.75   90.4 29.51837
## 4           4     F   1.72   85.3 28.83315
```

Let's create a new column, `obese`, for `BMI > 30`, as `TRUE` or `FALSE`. This also demonstrates the use of 'logicals' in R.

```
data$obese <- data$BMI > 30
head(data)

##  subject_id gender height weight      BMI obese
## 1           1     F   1.52   56.7 24.54120 FALSE
## 2           2     F   1.65   99.6 36.58402  TRUE
## 3           3     M   1.75   90.4 29.51837 FALSE
## 4           4     F   1.72   85.3 28.83315 FALSE
## 5           5     F   1.68   75.0 26.41512 FALSE
## 6           6     M   1.78  130.5 41.18798  TRUE
## 7           7     F   1.60   60.0 23.43750 FALSE
## 8           8     F   1.55   50.0 20.90171 FALSE
## 9           9     F   1.50   40.0 17.77778 FALSE
## 10          10     F   1.45   30.0 14.28571 FALSE
## ...
```

One can also use logical vectors to subset datasets in R. A logical vector, named "ob" here, is created and then we pass it through the square brackets `[]` to tell R to select only the rows where the condition `BMI > 30` is `TRUE`:

```
ob <- data$BMI > 30
data_ob <- data[ob, ];data_ob

##  subject_id gender height weight      BMI obese
## 2           2     F   1.65   99.6 36.58402  TRUE
## 6           6     M   1.78  130.5 41.18798  TRUE
```

### ***Combining Datasets (Called Data Frames in R)***

**Aim:** Often different variables (columns) of interest in a research question may come from separate MIMIC tables and could have been exported as separate.csv files if they were not merged via SQL queries. For ease of analysis and visualization, it is often desirable to merge these separate data frames in R on their shared ID column(s).

Occasionally, one may also want to attach rows from one data frame after rows from another. In this case, the column names and the number of columns of the two different datasets must be the same.

**Examples:** In general, there are a couple ways of combining columns and rows from different datasets in R:

- `merge()`—This function merges columns on shared ID column(s) between the data frames so the associated rows match up correctly.

Command: merging on one ID column, e.g.:

```
df_merged <- merge(df1, df2, by = "column_ID_name")
```

Command: merging on two ID columns, e.g.:

```
df_merged <- merge(df1, df2, by = c("column1", "column2"))
```

- `cbind()`—This function simply ‘add’ together the columns from two data frames (must have equal number of rows). It does not match up the rows by any identifier.

Command: joining columns. E.g.:

```
df_total <- cbind(df1, df2)
```

- `rbind()`—The function ‘row binds’ the two data frames vertically (must have the same column names).

Command: joining rows. E.g.:

```
df_total <- rbind(df1, df2)
```

### *Using Packages in R*

There are many packages that make life so much easier when manipulating data in R. They need to be installed on your computer and loaded at the start of your R script before you can call the functions in them. We will introduce examples of a couple of useful packages later in this chapter.

For now, the command for installing packages is:

```
install.packages("name_of_package_case_sensitive")
```

The command for loading the package into the R working environment:

```
library(name_of_package_case_sensitive)
```

Note—there are no quotation marks when loading packages as compared to installing; you will get an error message otherwise.

### ***Getting Help in R***

There are various online tutorials and Q&A forums for getting help in R. Stackoverflow, Cran and Quick-R are some good examples. Within the R console, a question mark, `?`, followed by the name of the function of interest will bring up the help menu for the function, e.g.

```
?head
```

### ***12.3.2 Data Integration***

**Aim:** This involves combining the separate output datasets exported from separate MIMIC queries into a consistent larger dataset table.

To ensure that the associated observations or rows from the two different datasets match up, the right column ID must be used. In MIMIC, the ID columns could be `subject_id`, `hadm_id`, `icustay_id`, `itemid`, etc. Hence, knowing the context of what each column ID is used to identify and how they are related to each other is important. For example, `subject_id` is used to identify each individual patient, so includes their date of birth (DOB), date of death (DOD) and various other clinical detail and laboratory values in MIMIC. Likewise, the hospital admission ID, `hadm_id`, is used to specifically identify various events and outcomes from an

unique hospital admission; and is also in turn associated with the `subject_id` of the patient who was involved in that particular hospital admission. Tables pulled from MIMIC can have one or more ID columns. The different tables exported from MIMIC may share some ID columns, which allows us to ‘merge’ them together, matching up the rows correctly using the unique ID values in their shared ID columns.

**Examples:** To demonstrate this with MIMIC data, a simple SQL query is constructed to extract some data, saved as: “population.csv” and “demographics.csv”.

We will use these extracted files to show how to merge datasets in R.

### 1. SQL query:

```
WITH
population AS(
SELECT subject_id, hadm_id, gender, dob, icustay_admit_age,
icustay_intime, icustay_outtime, dod, expire_flg
FROM mimic2v26.icustay_detail
  WHERE subject_icustay_seq = 1
  AND icustay_age_group = 'adult'
  AND hadm_id IS NOT NULL
)
, demo AS(
SELECT subject_id, hadm_id, marital_status_descr, ethnicity_descr
FROM mimic2v26.demographic_detail
WHERE subject_id IN (SELECT subject_id FROM population)
)

--# Extract the the datasets with each one of the following line of
codes in turn:
--SELECT * FROM population
--SELECT * FROM demo
```

*Note: Remove the – in front of the SELECT command to run the query.*

## 2. R code: Demonstrating data integration

Set working directory and read data files into R::

```
setwd("~/Desktop/MIMIC_data_files")
demo <- read.csv("demographics.csv", sep = ",")
pop <- read.csv("population.csv", sep = ",")
head(demo)

##  subject_id hadm_id marital_status_descr      ethnicity_descr
## 1           4   17296                SINGLE                WHITE
## 2           6   23467                MARRIED                WHITE
## 3           3    2075                MARRIED                WHITE
## ...
head(pop)

##  subject_id hadm_id gender      dob icustay_admit_age
## 1           4   17296      F 3351-05-30 00:00:00      47.84414
## 2           6   23467      F 3323-07-30 00:00:00      65.94048
## 3           3    2075      M 2606-02-28 00:00:00      76.52892
## ...

##           icustay_intime      icustay_outtime      dod
## expire_flg
## 1 3399-04-03 00:29:00 3399-04-04 16:46:00
## N
## 2 3389-07-07 20:38:00 3389-07-11 12:47:00
## N
## 3 2682-09-07 18:12:00 2682-09-13 19:45:00 2683-05-02 00:00:00
## Y
## ...
```

Merging pop and demo: Note to get the rows to match up correctly, we need to merge on both the `subject_id` and `hadm_id` in this case. This is because each subject/patient could have multiple `hadm_id` from different hospital admissions during the EHR course of MIMIC database.

```

demopop <- merge(pop, demo, by = c("subject_id", "hadm_id"))
head(demopop)

##   subject_id hadm_id gender          dob icustay_admit_age
## 1         100     445      F 3048-09-22 00:00:00          71.94482
## 2        1000    15170     M 2442-05-11 00:00:00          69.70579
## 3       10000   10444     M 3149-12-07 00:00:00          49.67315
## ...

##           icustay_intime      icustay_outtime          dod
## expire_flg
## 1 3120-09-01 11:19:00 3120-09-03 14:06:00
## N
## 2 2512-01-25 13:16:00 2512-03-02 06:05:00 2512-03-02 00:00:00
## Y
## 3 3199-08-09 09:53:00 3199-08-10 17:43:00
## N
## ...

## marital_status_descr      ethnicity_descr
## 1             WIDOWED UNKNOWN/NOT SPECIFIED
## 2             MARRIED UNKNOWN/NOT SPECIFIED
## 3                                     HISPANIC OR LATINO
## 4             MARRIED BLACK/AFRICAN AMERICAN
## 5             MARRIED                WHITE
## 6             SEPARATED BLACK/AFRICAN AMERICAN

```

As you can see, there are still multiple problems with this merged database, for example, the missing values for ‘marital\_status\_descr’ column. Dealing with missing data is explored in Chap. 13.

### 12.3.3 Data Transformation

**Aim:** To transform the presentation of data values in some ways so that the new format is more suitable for the subsequent statistical analysis. The main processes involved are normalization, aggregation and generalization (See part 1 for explanation).

**Examples:** To demonstrate this with a MIMIC database example, let us look at a table generated from the following simple SQL query, which we exported as “comorbidity\_scores.csv”.

The SQL query selects all the patient comorbidity information from the mim-ic2v26.comorbidity\_scores table on the condition of (1) being an adult, (2) in

his/her first ICU admission, and (3) where the hadm\_id is not missing according to the mimic2v26.icustay\_detail table.

### 1. SQL query:

```
SELECT *
FROM mimic2v26.comorbidity_scores
WHERE subject_id IN (SELECT subject_id
FROM mimic2v26.icustay_detail
WHERE subject_icustay_seq = 1
AND icustay_age_group = 'adult'
AND hadm_id IS NOT null)
```

### 2. R code: Demonstrating data transformation:

```
setwd("~/Desktop/MIMIC_data_files")
c_scores <- read.csv("comorbidity_scores.csv", sep = ",")
```

Note the ‘class’ or data type of each column/variable and the total number of rows (obs) and columns (variables) in c\_scores:

```
str(c_scores)

## 'data.frame': 27525 obs. of 33 variables:
## $ subject_id : int 2848 21370 2026 11890 27223 27520
17928 31252 32083 9545 ...
## $ hadm_id : int 16272 17542 11351 12730 32530
32724 20353 30062 32216 10809 ...
## $ category : Factor w/ 1 level "ELIXHAUSER": 1 1 1 1
1 1 1 1 1 1 ...
## $ congestive_heart_failure: int 0 0 0 0 1 0 0 0 1 1 ...
## $ cardiac_arrhythmias : int 0 1 1 0 1 0 0 0 0 1 ...
## $ valvular_disease : int 0 0 0 0 1 0 0 0 0 1 ...
## $ ...
```

Here we add a column in c\_scores to save the overall ELIXHAUSER. The rep() function in this case repeats 0 for nrow(c\_scores) times. Function, colnames(), rename the new or last column, [ncol(c\_scores)], as “ELIXHAUSER\_overall”.



```
c_scores <- cbind(c_scores, rep(0, nrow(c_scores)))
colnames(c_scores)[ncol(c_scores)] <- "ELIXHAUSER_overall"
```

Take a look at the result. Note the new “ELIXHAUSER\_overall” column added at the end:

```
str(c_scores)

## 'data.frame': 27525 obs. of 34 variables:
## $ subject_id : int 2848 21370 2026 11890 27223 27520
17928 31252 32083 9545 ...
## $ hadm_id : int 16272 17542 11351 12730 32530
32724 20353 30062 32216 10809 ...
## $ category : Factor w/ 1 level "ELIXHAUSER": 1 1 1 1
1 1 1 1 1 1 ...
## $ congestive_heart_failure: int 0 0 0 0 1 0 0 0 1 1 ...
## $ cardiac_arrhythmias : int 0 1 1 0 1 0 0 0 0 1 ...
## $ valvular_disease : int 0 0 0 0 1 0 0 0 0 1 ...
## $ ...
```

### Aggregation Step

**Aim:** To sum up the values of all the ELIXHAUSER comorbidities across each row. Using a ‘for loop’, for each *i*-th row entry in column “ELIXHAUSER\_overall”, we sum up all the comorbidity scores in that row.

```
for (i in 1:nrow(c_scores)) {
  c_scores[i, "ELIXHAUSER_overall"] <- sum(c_scores[i,4:33])
}
```

Let’s take a look at the head of the resulting first and last column:

```
head(c_scores[, c(1, 34)])

## subject_id ELIXHAUSER_overall
## 1 2848 1
## 2 21370 3
## 3 2026 3
## ...
```

**Normalization Step**

**Aim:** Scale values in column `ELIXHAUSER_overall` to between 0 and 1, i.e. in [0, 1]. Function, `max()`, finds out the maximum value in column `ELIXHAUSER_overall`. We then re-assign each entry in column `ELIXHAUSER_overall` as a proportion of the `max_score` to normalize/scale the column.

```
max_score <- max(c_scores[, "ELIXHAUSER_overall"])
c_scores[, "ELIXHAUSER_overall"] <- c_scores[,
"ELIXHAUSER_overall"]/max_score
```

We subset and remove all the columns in `c_score`, except for “`subject_id`”, “`hadm_id`”, and “`ELIXHAUSER_overall`”:

```
c_scores <- c_scores[, c("subject_id", "hadm_id",
"ELIXHAUSER_overall")]
head(c_scores)

##   subject_id hadm_id ELIXHAUSER_overall
## 1         2848   16272          0.09090909
## 2        21370   17542          0.27272727
## 3         2026   11351          0.27272727
## ...
```

**Generalization Step**

**Aim:** Consider only the patient sicker than the average Elixhauser score. The function, `which()`, return the row numbers (indices) of all the TRUE entries of the logical condition set on `c_scores` inside the round () brackets, where the condition being the column entry for `ELIXHAUSER_overall`  $\geq 0.5$ . We store the row indices information in the vector, ‘`sicker`’. Then we can use ‘`sicker`’ to subset `c_scores` to select only the rows/patients who are ‘`sicker`’ and store this information in ‘`c_score_sicker`’.

```
sicker <- which(c_scores[, "ELIXHAUSER_overall"] >= 0.5)
c_score_sicker <- c_scores[sicker, ]
head(c_score_sicker)

##   subject_id hadm_id ELIXHAUSER_overall
##  10         9545   10809             0.5454545
##  15        12049   27692             0.5454545
##  59        29801   33844             0.5454545
##  ...
```

Saving the results to file: There are several functions that will do this, e.g. `write.table()` and `write.csv()`. We will give an example here:

```
write.table(c_score_sicker, file = "c_score_sicker.csv", sep = ";",
row.names = F, col.names = F)
```

If you check in your working directory/folder, you should see the new “c\_score\_sicker.csv” file.

### 12.3.4 Data Reduction

**Aim:** To reduce or reshape the input data by means of a more effective representation of the dataset without compromising the integrity of the original data. One element of data reduction is eliminating redundant records while preserving needed data, which we will demonstrate in Example Part 1. The other element involves reshaping the dataset into a “tidy” format, which we will demonstrate in below sections.

#### *Examples Part 1: Eliminating Redundant Records*

To demonstrate this with a MIMIC database example, we will look at multiple records of non-invasive mean arterial pressure (MAP) for each patient. We will use the records from the following SQL query, which we exported as “mean\_arterial\_pressure.csv”.

The SQL query selects all the patient `subject_id`’s and noninvasive mean arterial pressure (MAP) measurements from the `mimic2v26.chartevents` table on the condition of (1) being an adult, (2) in his/her first ICU admission, and (3) where the `hadm_id` is not missing according to the `mimic2v26.icustay_detail` table.

### 1. SQL query:

```
SELECT subject_id, value1num
FROM mimic2v26.charthevents
WHERE subject_id IN (
  SELECT subject_id
    FROM mimic2v26.icustay_detail
     WHERE subject_icustay_seq = 1
     AND icustay_age_group = 'adult'
     AND hadm_id IS NOT null)
AND itemid=456
AND value1num is not null

-- Export and save the query result as "mean_arterial_pressure.csv"
```

### 2. R code:

There are a variety of methods that can be chosen to aggregate records. In this case we will look at averaging multiple MAP records into a single average MAP for each patient. Other options which may be chosen include using the first recorded value, a minimum or maximum value, etc.

For a basic example, the following code demonstrates data reduction by averaging all of the multiple records of MAP into a single record per patient. The code uses the `aggregate()` function:

```
setwd("~/Desktop/MIMIC_data_files")
all_maps <- read.csv("mean_arterial_pressure.csv", sep = ",")

str(all_maps)

## 'data.frame': 790174 obs. of 2 variables:
## $ subject_id: int 4 4 4 4 4 4 4 4 3 4 ...
## $ value1num : num 80.7 71.7 74.3 69 75 ...
```

This step averages the MAP values for each distinct `subject_id`:

```
avg_maps <- aggregate(all_maps, by=list(all_maps[,1]), FUN=mean,
na.rm=TRUE)

head(avg_maps)

## Group.1 subject_id value1num
## 1 3 3 75.10417
## 2 4 4 88.64102
## 3 6 6 91.37357
## ...
```

### Examples Part 2: Reshaping Dataset

**Aim:** Ideally, we want a “tidy” dataset reorganized in such a way so it follows these 3 rules [2, 3]:

1. Each variable forms a column
2. Each observation forms a row
3. Each value has its own cell

Datasets exported from MIMIC usually are fairly “tidy” already. Therefore, we will construct our own data frame here for ease of demonstration for rule 3. We will also demonstrate how to use some common data tidying packages.

**R code:** To mirror our own MIMIC dataframe, we construct a dataset with a column of subject\_id and a column with a list of diagnoses for the admission.

```
diag <- data.frame(subject_id = 1:6, diagnosis = c("PNA, CHF", "DKA",
"DKA, UTI", "AF, CHF", "AF", "CHF"))
diag
##   subject_id diagnosis
## 1          1  PNA, CHF
## 2          2      DKA
## 3          3  DKA, UTI
## ...
```

Note that the dataset above is not “tidy”. There are multiple categorical variables in column “diagnosis”—breaks “tidy” data rule 1. There are multiple values in column “diagnosis”—breaks “tidy” data rule 3.

There are many ways to “tidy” and reshape this dataset. We will show one way to do this by making use of R packages “splitstackshape” [5] and “tidyr” [4] to make reshaping the dataset easier.

#### R package example 1—“splitstackshape”:

Installing and loading the package into R console.

```
install.packages("splitstackshape")
library(splitstackshape)
```

The function, cSplit(), can split the multiple categorical values in each cell of column “diagnosis” into different columns, “diagnosis\_1” and “diagnosis\_2”. If the argument, direction, for cSplit() is not specified, then the function splits the original dataset “wide”.

```
diag2 <- cSplit(diag, "diagnosis", ",")
diag2
##   subject_id diagnosis_1 diagnosis_2
## 1:         1         PNA         CHF
## 2:         2         DKA          NA
## 3:         3         DKA         UTI
## ...
```

One could possibly keep it as this if one is interested in primary and secondary diagnoses (though it is not strictly “tidy” yet).

Alternatively, if the direction argument is specified as “long”, then cSplit split the function “long” like so:

```
diag3 <- cSplit(diag, "diagnosis", ",", direction = "long")
diag3
##   subject_id diagnosis
## 1:         1         PNA
## 2:         1         CHF
## 3:         2         DKA
## ...
```

Note diag3 is still not “tidy” as there are still multiple categorical variables under column diagnosis—but we no longer have multiple values per cell.

### R package example 2—“tidyr”:

To further “tidy” the dataset, package “tidyr” is pretty useful.

```
install.packages("tidyr")
library(tidyr)
```

The aim is to split each categorical variable under column, diagnosis, into their own columns with 1 = having the diagnosis and 0 = not having the diagnosis. To do this we first construct a third column, “yes”, that hold all the 1 values initially (because the function we are going use require a value column that correspond with the multiple categories column we want to ‘spread’ out).

```
diag3$yes <- rep(1, nrow(diag3))
diag3
##   subject_id diagnosis yes
## 1:         1      PNA   1
## 2:         1      CHF   1
## 3:         2      DKA   1
## ...
```

Then we can use the spread function to split each categorical variables into their own columns. The argument, fill = 0, replaces the missing values.

```
diag4 <- spread(diag3, diagnosis, yes, fill = 0)
diag4
##   subject_id AF CHF DKA PNA UTI
## 1:         1  0  1  0  1  0
## 2:         2  0  0  1  0  0
## 3:         3  0  0  1  0  1
## ...
```

One can see that this dataset is now “tidy”, as it follows all three “tidy” data rules.

## 12.4 Conclusion

A variety of quality control issues are common when using raw clinical data collected for non-study purposes. Data pre-processing is an important step in preparing raw data for statistical analysis. Several distinct steps are involved in pre-processing raw data as described in this chapter: cleaning, integration, transformation, and reduction. Throughout the process it is important to understand the choices made in pre-processing steps and how different methods can impact the validity and applicability of study results. In the case of EHR data, such as that in the MIMIC database, pre-processing often requires some understanding of the clinical context under which data were entered in order to guide these pre-processing choices. The objective of all the steps is to arrive at a “clean” and “tidy” dataset suitable for effective statistical analyses while avoiding inadvertent introduction of bias into the data.

## Take Home Messages

- Raw data for secondary analysis is frequently “messy” meaning it is not in a form suitable for statistical analysis; data must be “cleaned” into a valid, complete, and effectively organized “tidy” database that can be analyzed.
- There are a variety of techniques that can be used to prepare data for analysis, and depending on the methods used, this pre-processing step can introduce bias into a study.
- The goal of pre-processing data is to prepare the available raw data for analysis without introducing bias by changing the information contained in the data or otherwise influencing end results.

**Open Access** This chapter is distributed under the terms of the Creative Commons Attribution-NonCommercial 4.0 International License (<http://creativecommons.org/licenses/by-nc/4.0/>), which permits any noncommercial use, duplication, adaptation, distribution and reproduction in any medium or format, as long as you give appropriate credit to the original author(s) and the source, a link is provided to the Creative Commons license and any changes made are indicated.

The images or other third party material in this chapter are included in the work's Creative Commons license, unless indicated otherwise in the credit line; if such material is not included in the work's Creative Commons license and the respective action is not permitted by statutory regulation, users will need to obtain permission from the license holder to duplicate, adapt or reproduce the material.

## References

1. Son NH (2006) Data mining course—data cleaning and data preprocessing. Warsaw University. Available at URL <http://www.mimuw.edu.pl/~son/datamining/DM/4-preprocess.pdf>
2. Grolemund G (2016) R for data science—data tidying. O'Reilly Media. Available at URL <http://garrettgman.github.io/tidying/>
3. Wickham H (2014) J Stat Softw 59(10). Tidy Data. Available at URL <http://vita.had.co.nz/papers/tidy-data.pdf>
4. Wickham H (2016) Package ‘tidyr’—easily tidy data with spread() and gather() functions. CRAN. Available at URL <https://cran.r-project.org/web/packages/tidyr/tidyr.pdf>
5. Mahto A (2014) Package ‘splitstackshape’—stack and reshape datasets after splitting concatenated values. CRAN. Available at URL <https://cran.r-project.org/web/packages/splitstackshape/splitstackshape.pdf>



# Chapter 13

## Missing Data

Cátia M. Salgado, Carlos Azevedo, Hugo Proença  
and Susana M. Vieira

### Learning Objectives

- What are the different types of missing data, and the sources for missingness.
- What options are available for dealing with missing data.
- What techniques exist to help choose the most appropriate technique for a specific dataset.

### 13.1 Introduction

Missing data is a problem affecting most databases and electronic medical records (EHR) are no exception. Because most statistical models operate only on complete observations of exposure and outcome variables, it is necessary to deal with missing data, either by deleting incomplete observations or by replacing any missing values with an estimated value based on the other information available, a process called imputation. Both methods can significantly effect the conclusions that can be drawn from the data.

Identifying the source of “missingness” is important, as it influences the choice of the imputation technique. Schematically, several cases are possible: (i) the value is missing because it was forgotten or lost; (ii) the value is missing because it was not applicable to the instance; (iii) the value is missing because it is of no interest to the instance. If we were to put this in a medical context: (i) the variable is measured but for some unidentifiable reason the values are not electronically recorded, e.g. disconnection of sensors, errors in communicating with the database server, accidental human omission, electricity failures, and others; (ii) the variable is not measured during a certain period of time due to an identifiable reason, for instance the patient is disconnected from the ventilator because of a medical decision;

---

**Electronic supplementary material** The online version of this chapter (doi:[10.1007/978-3-319-43742-2\\_13](https://doi.org/10.1007/978-3-319-43742-2_13)) contains supplementary material, which is available to authorized users.

(iii) the variable is not measured because it is unrelated with the patient condition and provides no clinical useful information to the physician [1].

An important distinction must be made between data missing for identifiable or unidentified reasons. In the first case, imputing values can be inadequate and add bias to the dataset, so the data is said to be non-recoverable. On the other hand, when data is missing for unidentifiable reasons it is assumed that values are missing because of random and unintended causes. This type of missing data is classified as recoverable.

The first section of this chapter focuses on describing the theory of some commonly used methods to handle missing data. In order to demonstrate the advantages and disadvantages of the methods, their application is demonstrated in the second part of the chapter on actual datasets that were created to study the relation between mortality and insertion of indwelling arterial catheters (IAC) in the intensive care unit (ICU).

## 13.2 Part 1—Theoretical Concepts

In knowledge discovery in databases, data preparation is the most crucial and time consuming task, that strongly influences the success of the research. Variable selection consists in identifying a useful subset of potential predictors from a large set of candidates (please refer to Chap. 5—Data Analysis for further information on feature selection). Rejecting variables with an excessive number of missing values (e.g. >50 %) is usually a good rule of thumb, however it is not a risk-free procedure. Rejecting a variable may lead to a loss of predictive power and ability to detect statistically significant differences and it can be a source of bias, affecting the representativeness of the results. For these reasons, variable selection needs to be tailored to the missing data mechanism. Imputation can be done before and/or after variable selection.

The general steps that should be followed for handling missing data are:

- Identify patterns and reasons for missing data;
- Analyse the proportion of missing data;
- Choose the best imputation method.

### 13.2.1 *Types of Missingness*

The mechanisms by which the data is missing will affect some assumptions supporting our data imputation methods. Three major mechanisms of missingness of the data can be described, depending on the relation between observed (available) and unobserved (missing) data.

For the sake of simplicity, let's consider missingness in the univariate case. To define missingness in mathematical terms, a dataset  $X$  can be divided in two parts:

$$X = \{X_o, X_m\} \quad (1)$$

where  $X_o$  corresponds to the observed data, and  $X_m$  to the missing data, in the dataset.

For each observation we define a binary response whether or not that observation is missing:

$$R = \begin{cases} 1 & \text{if } X \text{ observed} \\ 0 & \text{if } X \text{ missing} \end{cases} \quad (2)$$

The missing value mechanism can be understood in terms of the probability that an observation is missing  $\Pr(R)$  given the observed and missing observations, in the form:

$$\Pr(R|x_o, x_m) \quad (3)$$

The three mechanisms are subject to whether the probability of response  $R$  depends or not on the observed and/or missing values:

- **Missing Completely at Random (MCAR)**—When the missing observations are dependent on the observed and unobserved measurements. In this case the probability of an observation being missing depends only on itself, and reduces to  $\Pr(R|x_o, x_m) = \Pr(R)$ . As an example, imagine that a doctor forgets to record the gender of every six patients that enter the ICU. There is no hidden mechanism related to any variable and it does not depend on any characteristic of the patients.
- **Missing at Random (MAR)**—In this case the probability of a value being missing is related only to the observable data, i.e., the observed data is statistically related with the missing variables and it is possible to estimate the missing values from the observed data. This case is not completely ‘random’, but it is the most general case where we can ignore the missing mechanism, as we control the information upon which the missingness depends, the observed data. Said otherwise, the probability that some data is missing for a particular variable does not depend on the values of that variable, after adjusting for observed values. Mathematically the probability of missing reduces to  $\Pr(R|x_o, x_m) = \Pr(R|x_o)$ . Imagine that if elderly people are less likely to inform the doctor that they had had a pneumonia before, the response rate of the variable pneumonia will depend on the variable age.
- **Missing Not at Random (MNAR)**—This refers to the case when neither MCAR nor MAR hold. The missing data depends on both missing and observed values. Determining the missing mechanism is usually impossible, as it depends on unseen data. From that derives the importance of performing sensitivity analyses and test how the inferences hold under different assumptions. For example, we can imagine that patients with low blood pressure are more likely to have their blood pressure measured less frequently (the missing data for the variable “blood pressure” partially depends on the values of the blood pressure).

### 13.2.2 Proportion of Missing Data

The percentage of missing data for each variable (between patients) and each patient (between variables) must be computed, to help decide which variables and/or patients should be considered candidates for removal or data imputation. A crude example is shown in Table 13.1, where we might want to consider removing patient 1 and the variable “AST” from the analysis, considering that most of their values are missing.

### 13.2.3 Dealing with Missing Data

#### Overview of Methods for Handling Missing Data

The methods should be tailored to the dataset of interest, the reasons for missingness and the proportion of missing data. In general, a method is chosen for its simplicity and its ability to introduces as little bias as possible in the dataset.

When data are MCAR or MAR a researcher can ignore the reasons for missing data, which simplifies the choice of the methods to apply. In this case, any method can be applied. Nevertheless it is difficult to obtain empirical evidence about whether or not the data are MCAR or MAR. A valid strategy is to examine the sensitivity of results to the MCAR and MAR assumptions by comparing several analyses, where the differences in results across several analyses may provide some information about what assumptions may be the most relevant.

A significant body of evidence has focused on comparing the performance of missing data handling methods, both in general [2–4] and in context of specific factors such as proportion of missing data and sample size [5–7]. More detailed technical aspects, and application of these methods in various fields can also be found in the works of Jones and Little [8, 9].

In summary, the most widely used methods fall into three main categories, which are described in more detail below.

1. Deletion methods (listwise deletion, i.e. complete-case analysis, pairwise deletion, i.e. available-case analysis)
2. Single Imputation Methods (mean/mode substitution, linear interpolation, Hot deck and cold deck)
3. Model-Based Methods (regression, multiple imputation, k-nearest neighbors)

**Table 13.1** Examples of missing data in EHR

	Gender	Glucose	AST	Age
Patient 1	?	120	?	?
Patient 2	M	105	?	68
Patient 3	F	203	45	63
Patient 4	M	145	?	42
Patient 5	M	89	?	80

### ***Deletion Methods***

The simplest way to deal with missing data is to discard the cases or observations that have missing values. In general, case deletion methods lead to valid inferences only for MCAR [10]. There are three ways of doing this: complete-case analysis; available-case analysis; and weighting methods.

#### **Complete-Case Analysis (Listwise Deletion)**

In complete case analysis, all the observations with at least one missing variable are discarded (Fig. 13.1).

The principal assumption is that the remaining subsample is representative of the population, and will thus not bias the analysis towards a subgroup. This assumption is rather restrictive and assumes a MCAR mechanism. Listwise deletion often produces unbiased regression slope estimates, as long as missingness is not a function of the outcome variable. The biggest advantage of this method is its simplicity, it is always reasonable to use it when the number of discarded observations is relatively small when compared to the total. Its main drawbacks are the reduced statistical power (because it reduces the number of samples  $n$ , the estimates will have larger standard errors), waste of information, and possible bias of the analysis specially if data is not MCAR.

**Fig. 13.1** Example of complete-case deletion. Cases highlighted in red are discarded

Gender	GLUCOSE	Age
M	?	65
F	120	71
F	99	?
F	140	52
M	88	?
F	85	63
M	170	68
?	153	80
M	115	59
F	103	?

### Available-Case Analysis

The available-case method discards data only in the variables that are needed for a specific analysis. For example, if only 4 out of 20 variables are needed for a study, this method would only discard the missing observations of the 4 variables of interest. In Fig. 13.2, imagine that each one of the three represented variables would be used for a different analysis. The analysis is performed using all cases in which the variables of interest are present. Even though this method has the ability to preserve more information, the populations of each analysis would be different and possibly non-comparable.

### Weighting-Case Analysis

Weighting is a way of weighting the complete-cases by modelling the missingness in order to reduce the bias introduced in the available-case.

### *Single-Value Imputation*

In single imputation, missing values are filled by some type of “predicted” values [9, 11]. Single imputation ignores uncertainty and almost always underestimates the variance. Multiple imputation overcomes this problem, by taking into account both within—and between—imputation uncertainty.

**Fig. 13.2** Example of available-case deletion. If each variable is used for separate analyses, only the cases in which the variable of interest is missing are discarded

Case Study		
S1	S2	S3
Gender	GLUCOSE	Age
M	?	65
F	120	71
F	99	?
F	140	52
M	88	?
F	85	63
M	170	68
?	153	80
M	115	59
F	103	?

## Mean and Median

The simplest imputation method is to substitute missing values by the mean or the median of that variable. Using the median is more robust in the presence of outliers in the observed data. The main disadvantages are that (1) it reduces variability, thereby lowering the estimate errors compared to deletion approaches, and (2) it disregards the relationship between variables, decreasing therefore their correlation. While this method diminishes the bias of using a non-representative sample, it introduces other bias.

## Linear Interpolation

This method is particularly suitable for time-series. In linear interpolation, a missing value is computed by interpolating the values of the previous and next available measurements for the patient. For example, if the natremia changes from 132 to 136 mEq/L in 8 h, one can reasonably assume that its value was close to 134 mEq/L at midpoint.

## Hot Deck and Cold Deck

In the hot deck method, a missing attribute value is replaced with a value from an estimated distribution of the current data. It is especially used in survey research [9]. Hot deck is typically implemented in two stages. First, the data is partitioned into clusters, and then each instance with missing data is associated with one cluster. The complete cases in a cluster are used to fill in the missing values. This can be done by calculating the mean or mode of the attribute within a cluster. Cold deck imputation is similar to hot deck, except that the data source is different from the current dataset. Hot-deck imputation replaces the missing data by realistic values that preserve the variable distribution. However it underestimates the standard errors and the variability [12].

## Last Observation Carried Forward

Sometimes called “sample-and-hold” method [13]. The last value carried forward method is specific to longitudinal designs. This technique imputes the missing value with the last available observation of the individual. This method makes the assumption that the observation of the individual has not changed at all since the last measured observation, which is often unrealistic [14].

### ***Model-Based Imputation***

In model-based imputation, a predictive model is created to estimate values that will substitute the missing data. In this case, the dataset is divided into two subsets: one with no missing values for the variable under evaluation (used for training the model) and one containing missing values, that we want to estimate. Several modeling methods can be used such as: regression, logistic regression, neural networks and other parametric and non-parametric modeling techniques. There are two main drawbacks in this approach: the model estimates values are usually more well-behaved than the true values, and the models perform poorly if the observed and missing variables are independent.

### Linear Regression

In this model, all the available variables are used to create a linear regression model using the available observations of the variable of interest as output. The advantages of this method is that it takes into account the relationship between variables, unlike the mean/median imputation. The disadvantages are that it overestimates the model fit and the correlation between the variables, as it does not take into account the uncertainty in the missing data and underestimates variances and covariances. A method that was created to introduce uncertainty is the stochastic linear regression (see below).

The case of multivariate imputation is more complex as missing values exist for several variables, which do not follow the same pattern of missingness through the observations. The method used is a multivariate extension of the linear model and relies on an iterative process carried until convergence.

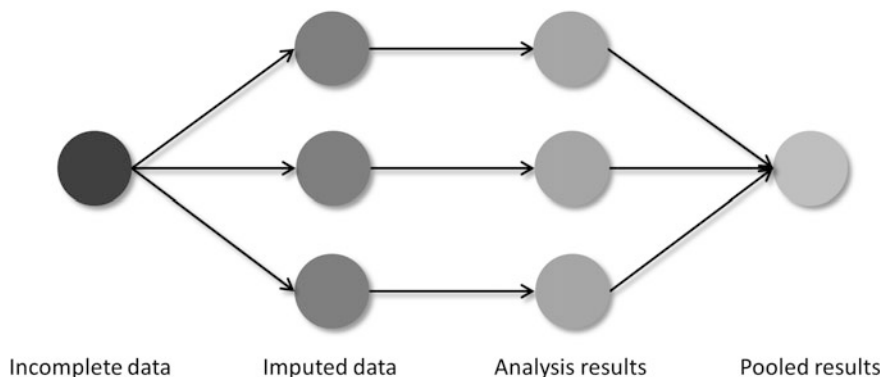
### Stochastic Regression

Stochastic regression imputation aims to reduce the bias by an extra step of augmenting each predicted score with a residual term. This residual term is normally distributed with a mean of zero and a variance equal to the residual variance from the regression of the predictor on the target. This method allows to preserve the variability in the data and unbiased parameter estimates with MAR data. However, the standard error tends to be underestimated, because the uncertainty about the imputed values is not included, which increases the risk of type I error [15].

### Multiple-Value Imputation

Multiple Imputation (MI) is a powerful statistical technique developed by Rubin in the 1970s for analysing datasets containing missing values [7, 16]. It is a Monte Carlo technique that requires 3 steps (Fig. 13.3).





**Fig. 13.3** The concept of multiple imputation, with  $M = 3$

- Imputation, where the missing values are filled in using any method of choice, leading to  $M \geq 2$  completed datasets (5–10 is generally sufficient) [10]. In these  $M$  multiply-imputed datasets, all the observed values are the same, but the imputed values are different, reflecting the uncertainty about imputation [10].
- Analysis: each of the  $M$  completed datasets is analysed (e.g. a logistic regression classifier for mortality prediction is built), which gives  $M$  analyses.
- Pooling: the  $M$  analyses are integrated into a final result, for example by computing the mean (and 95 % CI) of the  $M$  analyses.

### K-Nearest Neighbors

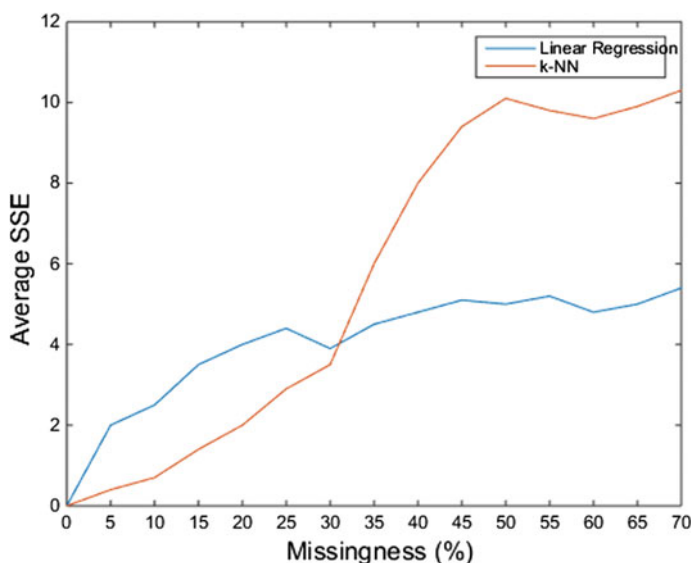
K-nearest neighbors (kNN) can be used for handling missing values. Here, they will be filled with the mean of the  $k$  values coming from the  $k$  most similar complete observations. The similarity of two observations is determined, after normalization of the dataset, using a distance function which can be Euclidean, Manhattan, Mahalanobis, Pearson, etc. The main advantage of the kNN algorithm is that given enough data it can predict with a reasonable accuracy the conditional probability distribution around a point and thus make well informed estimations. It can predict qualitative and quantitative (discrete and continuous) attributes. Another advantage of this method is that the correlation structure of the data is taken into consideration. The choice of the  $k$ -value is very critical. A higher value of  $k$  would include attributes which are significantly different from our target observation, while lower value of  $k$  implies missing out of significant attributes.

### 13.2.4 Choice of the Best Imputation Method

Different imputation methods are expected to perform differently on various datasets. We describe here a generic and simple method that can be used to evaluate the performance of various imputation methods on your own dataset, in order to help selecting the most appropriate method. Of note, this simple approach does not test the effect of deletion methods. A more complex approach is described in the case study below, in which the performance of a predictive model is tested on the dataset completed by various imputation methods.

Here is how to proceed:

1. Use a sample of your own dataset that does not contain any missing data (will serve as ground truth).
2. Introduce increasing proportions of missing data at random (e.g. 5–50 % in 5 % increments).
3. Reconstruct the missing data using the various methods.
4. Compute the sum of squared errors between the reconstructed and the original data, for each method and each proportion of missing data.
5. Repeat steps 1–4 a number of times (10 times for example) and compute the average performance of each method (average SSE).
6. Plot the average SSE versus proportion of missing data (1 plot per imputation method), similarly to the example shown in Fig. 13.4.



**Fig. 13.4** Average SSE between original and reconstructed data, for various levels of missingness and 2 imputation methods (data only for illustrative purposes)

7. Choose the method that performs best at the level of missing data in your dataset. E.g. if your data had 10 % of missing data, you would want to pick k-NN; at 40 % linear regression performs better (made-up data, for illustrative purpose only).

### 13.3 Part 2—Case Study

In this section, various imputation methods will be applied to two “real world” clinical datasets used in a study that investigated the effect of inserting an indwelling arterial catheter (IAC) in patients with respiratory failure. Two datasets are used, and include patients that received an IAC (IAC group) and patients that did not (non-IAC). Each dataset is subdivided into 2 classes, with class 1 corresponding to patients that died within 28 days and class 0 to survivors. The proportion of missing data and potential reasons for missingness are discussed first. The following analyses were then carried out:

1. Various proportions of missing data at random were inserted into the variable “age”, then imputed using the various methods described above. The distribution of the imputed observations was compared to the original distribution for all the methods.
2. The performance of imputed datasets with different degrees of missingness was tested on a predictive model (logistic regression to predict mortality), first for univariate missing data (the variable age), then for all the variables (multivariate).

The code used to generate the analyses and the figures is provided in the in the accompanying R functions document.

#### *13.3.1 Proportion of Missing Data and Possible Reasons for Missingness*

Table 13.2 shows the proportion of missing data in some of the variables of the datasets. 26 variables represent the subset that was considered for testing the different imputation methods, and were selected based on the assumption that missing data occurring in these variables is recoverable.

Since IAC are mainly used for continuous hemodynamic monitoring and for arterial blood sampling for blood gas analysis, we can expect a higher percentage of missing data in blood gas-related variables in the non-IAC group. We can also expect that patient diagnoses are often able to provide an explanation for the lack of specific laboratory results: if a certain test is not ordered because it will most likely provide no clinical insight, a missing value will occur; it is fair to estimate that such

**Table 13.2** Missing data in some of the variables of the IAC and non-IAC datasets

	IAC		Non-IAC	
	# points	%	# points	%
Arterial line time day	0	0	792	100
Hospital length of stay	0	0	0	0
Age	0	0	0	0
Gender	0	0	0	0
Weight first	39	3.96	71	8.96
SOFA first	2	0.20	4	0.51
Hemoglobin first	2	0.20	5	0.63
Bilirubin first	418	42.48	365	46.09
...				

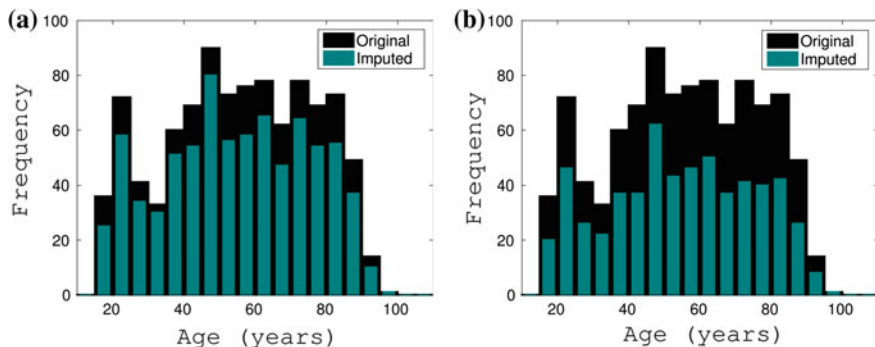
value lies within a normal range. In both cases, the fact that data is missing contains information about the response, thus it is MNAR. Body mass index (BMI) has a relatively high percentage of missing data. Assuming that this variable is calculated automatically from the weight and height of patients, we can conclude that this data is MAR: because the height and/or weight are missing, BMI cannot be calculated. If the weight is missing because someone forgot to introduce it into the system then it is MCAR. Besides the missing data mechanism, it is also important to consider the sample distribution in each variable, as some imputation methods assume specific data distributions, usually the normal distribution.

### 13.3.2 Univariate Missingness Analysis

In this section, the specific influence of each imputation method will be explored for the variable age, using all the other variables. Two different levels of missingness (20 and 40 %) were artificially introduced in the datasets. The original dataset represents the ground truth, to which the imputed datasets were compared using frequency histograms.

#### *Complete-Case Analysis*

The complete-case analysis method discards all the incomplete observations with at least one missing value. The distribution of the “imputed” dataset is going to be equal to the original dataset minus the observations that have a missing value in variable age. Figure 13.5 shows an example of the distribution of the variable age in the IAC group.



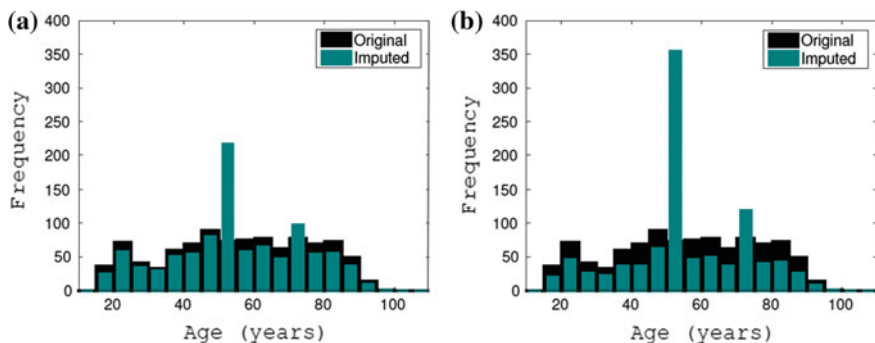
**Fig. 13.5** Histogram of variable age in the IAC group before and after univariate complete case method

This method is only exploitable when there is a small percentage of missing data. This method does not require any assumption in the distribution of the missing data, besides that the complete cases should be representative of the original population, which is difficult to prove.

**Single Value Imputation**

**Mean and Median Imputation**

Mean and median methods are very crude imputation techniques, which ignore the relationship between age and the other variables and introduce a heavy bias towards the mean/median values. These simple methods allow us to better understand the biasing effect, something that is obvious in the examples Fig. 13.6.



**Fig. 13.6** Histogram of variable age in the IAC group before (original) and after (imputed) mean for univariate imputation

## Linear Regression Imputation

The linear regression method imputes most of the data at the center of the distribution (example in Fig. 13.7). The extremities of the distribution are not well modeled and are easily ignored. This is due to two features of this technique: first, the assumption that the linear regression is a good fit to the data, and second, the assumption that the missing data lays over the regression line, bending the reality to fit the deterministic nature of the model. Compared to the mean/median imputation, the linear regression assumes a relation between the variables, however it overestimates this relation by assuming that the missing points are over the regression line. The model assumes that the percentage of variance explained is 100 %, thus it underestimates variability.

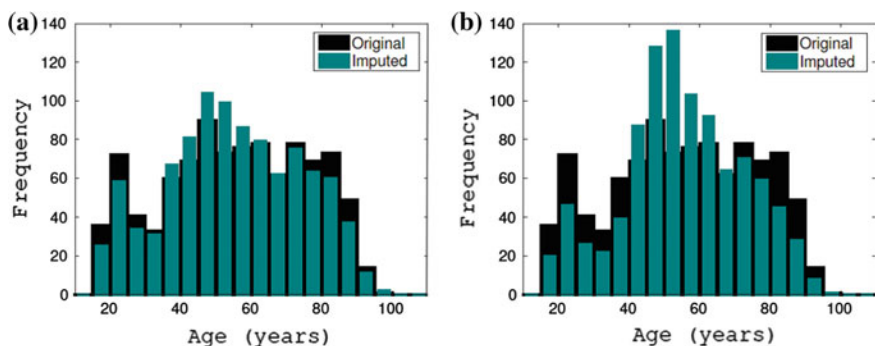
## Stochastic Linear Regression Imputation

The stochastic linear regression is an attempt to loosen the deterministic assumption of the linear regression. In this case, the distribution of the imputed data fits better the original data than previous methods (Fig. 13.8). This method can introduce impossible values, such as negative age. It is a first step to model the uncertainty present in the dataset that represents a trade-off between the precision of the values and the uncertainty introduced by the missing data.

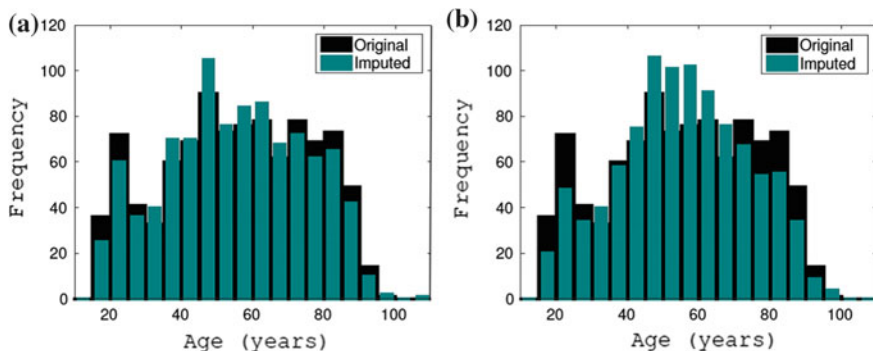
### *K-Nearest Neighbors*

We limit the demonstration to the case where  $k = 1$ . In the extreme case where all neighbors are used without weights, this method converges to the mean imputation.

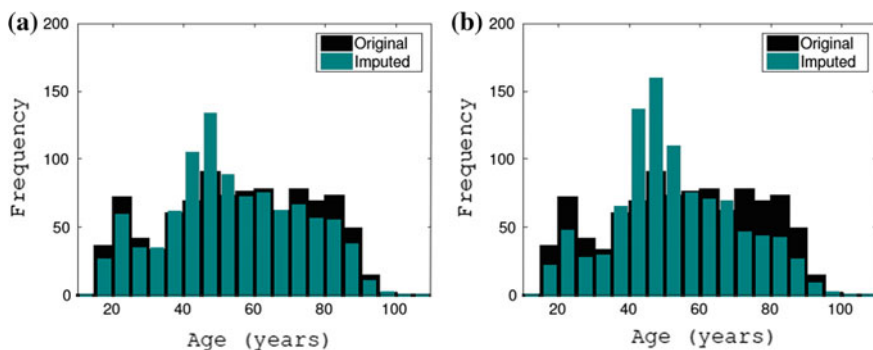
Figure 13.9 demonstrates that this method introduces in our particular dataset a huge bias towards the central value. The reason for this arises from the fact that



**Fig. 13.7** Histogram of the variable age in the IAC group before (original) and after (imputed) linear for univariate imputation



**Fig. 13.8** Histogram of variable age in the IAC group before (original) and after (imputed) stochastic linear for univariate imputation

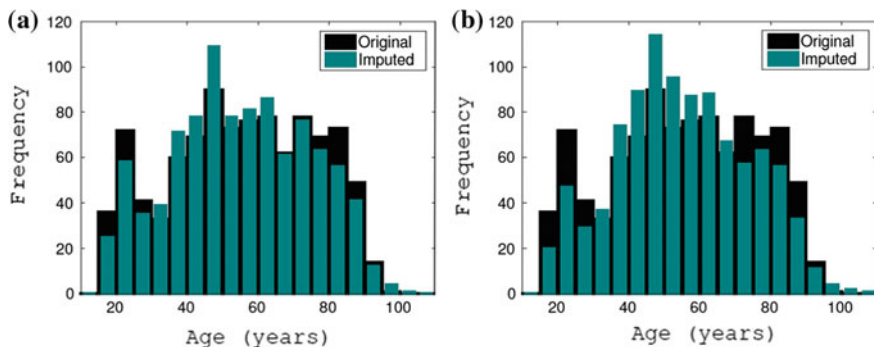


**Fig. 13.9** Histogram of variable age in the IAC group before (original) and after (imputed) KNN for univariate imputation

almost half of the variables are binary, which end up having a much higher weight on the distances than continuous variables (which are always less than 1, due to the unitary normalization performed in data pre-processing). Computations with kNN increase in quality with the number of observations in the dataset, and indeed this method is very powerful given the right conditions.

**Multiple Imputation**

Multiple imputation with linear regression and multivariate normal regression are extensions of the single imputation methods of the same name and use sampling to create multiple different datasets, that represent different possibilities of what might be the original dataset. These methods allow a better modeling of the uncertainty present in the missing values and are, usually, more solid in terms of statistical



**Fig. 13.10** Histogram of variable age in the IAC group before (original) and after (imputed) multiple imputation multivariate normal regression for univariate imputation

properties and results. We chose to work with 10 datasets, which were averaged so that the graphical representation would look similar to the previous methods.

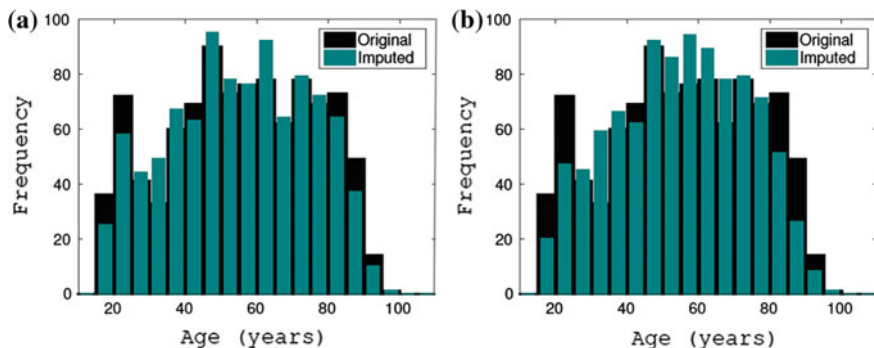
### Multivariate normal regression

Multiple imputation multivariate normal distribution gave more importance to the values of the center of the distribution (Fig. 13.10). The main assumption of this method is that the data follows a multivariate normal distribution, something that is not completely true for this dataset, which contains numerous binary variables. Nonetheless, even in the presence of categorical variables and distributions that are not strictly normal, it should perform reasonably well [10, 19]. The multiple imputation method enhances the modeling of uncertainty by adding a bootstrap sampling to the expectation maximization algorithm, giving raise to better predictions of the possible missing data by considering multiple possibilities of the original data. Obviously, when averaging the data for histogram representation, some of that richness is lost. Nonetheless, the quality of the regression is obvious when compared to the previous methods.

### Linear regression

The multiple imputation linear regression method uses all the variables except the target variable (age) to estimate the missing data of this last variable. The data is modelled using linear regression and Gibbs sampling. Figure 13.11 demonstrates that this represents by far the most accurate imputation method in this particular dataset.





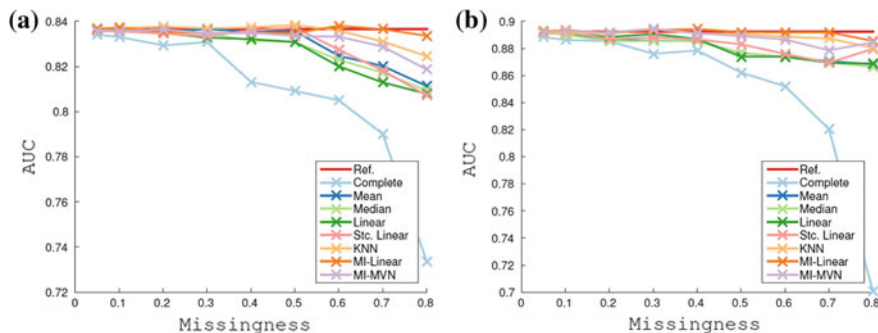
**Fig. 13.11** Histogram of variable age in the IAC group before (original) and after (imputed) multiple imputation generalized regression for univariate imputation

### 13.3.3 *Evaluating the Performance of Imputation Methods on Mortality Prediction*

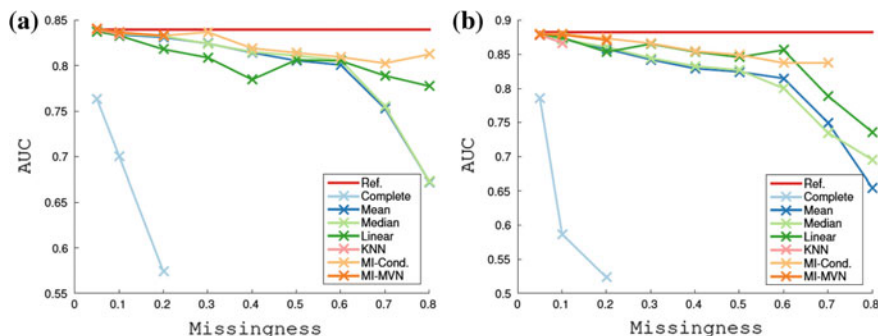
This test aims to assess the generalization capabilities of the models constructed using imputed data, and check their performance by comparing them to the original data. All the methods described previously were used to reconstruct a sample of both IAC and non-IAC datasets, with increasing proportions of missing data at random, first only on the variable age (univariate), then on all the variables in the dataset (multivariate). A logistic regression model was built on the reconstructed data and tested on a sample of the original data (that does not contain imputations or missing data).

The performance of the models is evaluated in terms of area under the receiver operating characteristic curve (AUC), accuracy (correct classification rate), sensitivity (true positive classification rate—TPR, also known as recall), specificity (true negative classification rate—TNR) and Cohen’s kappa. All the methods were compared against a reference logistic regression that was fitted with the original data without missingness. The results were averaged over a 10-fold cross validation and the AUC results are presented graphically.

The influence of one variable has a limited effect, even if age is the variable most correlated with mortality (Fig. 13.12). At most, the AUC decreased from 0.84 to 0.81 for IAC and from 0.90 to 0.87 for the non-IAC case, if we exclude the complete-case analysis method that performs poorly from the beginning. For lower values of missingness (less than 50 %), all the other models perform similarly. Among univariate techniques, the methods that performed the best on both datasets are the two multiple imputation methods, namely the linear regression and the multivariate normal distribution, and the one-nearest neighbors algorithm. In the case of univariate missingness, the nearest neighbors reveals to be a good estimator if several complete observations exist, as it is the case. With increasing of the



**Fig. 13.12** Mean AUC performance of the logistic regression models modelled with different imputation methods for different degrees of univariate missingness of the Age variable



**Fig. 13.13** Mean AUC of the logistic regression models for different degrees of multivariate missingness

missingness, the simpler methods introduced more bias in the modeling of the datasets.

The quality of the imputation methods was also evaluated in the presence of multivariate missingness with an uniform probability in all variables (Fig. 13.13). It has to be noted that obtaining results for more than 40 % of missingness in all the variables is quite infeasible in most cases, and there are no assurances of good performances with any of the methods. Some methods were not able to perform complete imputations over a certain degree of missingness (e.g. the complete-case analysis stopped having enough observations after 20 % of missingness).

Overall, and quite surprisingly, the methods had a reasonable performance even for 80 % of missingness in every variable. The reason behind this is that almost half of the variables are binary, and because of their relation with the output, reconstructing them from frequent values in each class is usually the best guess. The decrease in AUC was due to a decrease in the sensitivity, as the specificity values remained more or less unchanged with the increase in missingness. The method that performed the best overall in terms of AUC was the multiple imputation linear

regression. In IAC it achieved a minimum value of AUC of 0.81 at 70 % of missingness, corresponding to a reference AUC of 0.84 and in non-IAC it achieved an AUC of 0.85 at 70 % of missingness, close to the reference AUC of 0.89.

## 13.4 Conclusion

Missing data is a widespread problem in EHR due to the nature of medical information itself, the massive amounts of data collected, the heterogeneity of data standards and recording devices, data transfers and conversions, and finally Human errors and omissions. When dealing with the problem of missing data, just like in many other domains of data mining, there is no one-size-fits-all approach, and the data scientist should ultimately rely on robust evaluation tools when choosing an imputation method to handle missing values in a particular dataset.

### Take-Home Messages

- Always evaluate the reasons for missingness: is it MCAR/MAR/MNAR?
- What is the proportion of missing data per variable and per record?
- Multiple imputation approaches generally perform better than other methods.
- Evaluation tools must be used to tailor the imputation methods to a particular dataset.

**Open Access** This chapter is distributed under the terms of the Creative Commons Attribution-NonCommercial 4.0 International License (<http://creativecommons.org/licenses/by-nc/4.0/>), which permits any noncommercial use, duplication, adaptation, distribution and reproduction in any medium or format, as long as you give appropriate credit to the original author(s) and the source, a link is provided to the Creative Commons license and any changes made are indicated.

The images or other third party material in this chapter are included in the work's Creative Commons license, unless indicated otherwise in the credit line; if such material is not included in the work's Creative Commons license and the respective action is not permitted by statutory regulation, users will need to obtain permission from the license holder to duplicate, adapt or reproduce the material.

## References

1. Cismondi F, Fialho AS, Vieira SM, Reti SR, Sousa JMC, Finkelstein SN (2013) Missing data in medical databases: impute, delete or classify? *Artif Intell Med* 58(1):63–72
2. Peng CY, Harwell MR, Liou SM, Ehman LH (2006) Advances in missing data methods and implications for educational research
3. Peugh JL, Enders CK (2004) Missing data in educational research: a review of reporting practices and suggestions for improvement. *Rev Educ Res* 74(4):525–556
4. Young W, Weckman G, Holland W (2011) A survey of methodologies for the treatment of missing values within datasets: limitations and benefits. *Theor Issues Ergon Sci* 12(1):15–43

5. Alesh M (2009) The impact of missing data in a generalized integer-valued autoregression model for count data. *J Biopharm Stat* 19(6):1039–1054
6. Knol MJ, Janssen KJM, Donders ART, Egberts ACG, Heerdink ER, Grobbee DE, Moons KGM, Geerlings MI (2010) Unpredictable bias when using the missing indicator method or complete case analysis for missing confounder values: an empirical example. *J Clin Epidemiol* 63(7):728–736
7. Little RJA, Rubin DB (2002) Missing data in experiments. In: *Statistical analysis with missing data*. Wiley, pp 24–40
8. Jones MP (1996) Indicator and stratification methods for missing explanatory variables in multiple linear regression. *J Am Stat Assoc* 91(433):222–230
9. Little RJA (2016) *Statistical analysis with missing data*. Wiley, New York
10. Schafer JL (1999) Multiple imputation: a primer. *Stat Methods Med Res* 8(1):3–15
11. de Waal T, Pannekoek J, Scholtus S (2011) *Handbook of statistical data editing and imputation*. Wiley, New York
12. Roth PL (1994) Missing data: a conceptual review for applied psychologists. *Pers Psychol* 47(3):537–560
13. Hug CW (2009) *Detecting hazardous intensive care patient episodes using real-time mortality models*. Thesis, Massachusetts Institute of Technology
14. Wood AM, White IR, Thompson SG (2004) Are missing outcome data adequately handled? A review of published randomized controlled trials in major medical journals. *Clin Trials* 1(4):368–376
15. Enders CK (2010) *Applied missing data analysis*, 1st edn. The Guilford Press, New York
16. Rubin DB (1988) An overview of multiple imputation. In: *Proceedings of the survey research section, American Statistical Association*, pp 79–84
17. Saeed M, Villarroel M, Reisner AT, Clifford G, Lehman L-W, Moody G, Heldt T, Kyaw TH, Moody B, Mark RG (2011) Multiparameter intelligent monitoring in intensive care II (MIMIC-II): a public-access intensive care unit database. *Crit Care Med* 39(5):952–960
18. Scott DJ, Lee J, Silva I, Park S, Moody GB, Celi LA, Mark RG (2013) Accessing the public MIMIC-II intensive care relational database for clinical research. *BMC Med Inform Decis Mak* 13(1):9
19. Schafer JL, Olsen MK (1998) Multiple imputation for multivariate missing-data problems: a data analyst’s perspective. *Multivar Behav Res* 33(4):545–571

# Chapter 14

## Noise Versus Outliers

Cátia M. Salgado, Carlos Azevedo, Hugo Proença  
and Susana M. Vieira

### Learning Objectives

- What common methods for outlier detection are available.
- How to choose the most appropriate methods.
- How to assess the performance of an outlier detection method and how to compare different methods.

## 14.1 Introduction

An outlier is a data point which is different from the remaining data [1]. Outliers are also referred to as *abnormalities*, *discordants*, *deviants* and *anomalies* [2]. Whereas noise can be defined as mislabeled examples (class noise) or errors in the values of attributes (attribute noise), outlier is a broader concept that includes not only errors but also discordant data that may arise from the natural variation within the population or process. As such, outliers often contain interesting and useful information about the underlying system. These particularities have been exploited in fraud control, intrusion detection systems, web robot detection, weather forecasting, law enforcement and medical diagnosis [1], using in general methods of supervised outlier detection (see below).

Within the medical domain in general, the main sources of outliers are equipment malfunctions, human errors, anomalies arising from patient specific behaviors and natural variation within patients. Consider for instance an anomalous blood test result. Several reasons can explain the presence of outliers: severe pathological states, intake of drugs, food or alcohol, recent physical activity, stress, menstrual cycle, poor blood sample collection and/or handling. While some reasons may point to the existence of patient-specific characteristics discordant with the “average”

---

**Electronic supplementary material** The online version of this chapter (doi:[10.1007/978-3-319-43742-2\\_14](https://doi.org/10.1007/978-3-319-43742-2_14)) contains supplementary material, which is available to authorized users.

patient, in which case the observation being an outlier provides useful information, other reasons may point to human errors, and hence the observation should be considered for removal or correction. Therefore, it is crucial to consider the causes that may be responsible for outliers in a given dataset before proceeding to any type of action.

The consequences of not screening the data for outliers can be catastrophic. The negative effects of outliers can be summarized in: (1) increase in error variance and reduction in statistical power; (2) decrease in normality for the cases where outliers are non-randomly distributed; (3) model bias by corrupting the true relationship between exposure and outcome [3].

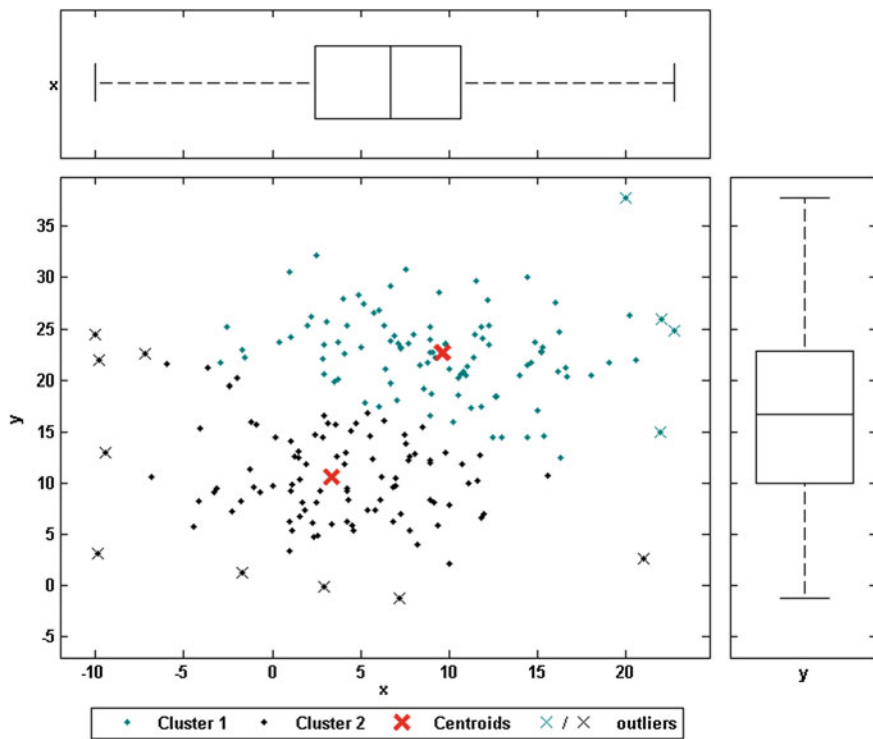
A good understanding of the data itself is required before choosing a model to detect outliers, and several factors influence the choice of an outlier identification method, including the type of data, its size and distribution, the availability of ground truth about the data, and the need for interpretability in a model [2]. For example, regression-based models are better suited for finding outliers in linearly correlated data, while clustering methods are advisable when the data is not linearly distributed along correlation planes. While this chapter provides a description of some of the most common methods for outlier detection, many others exist.

Evaluating the effectiveness of an outlier detection algorithm and comparing the different approaches is complex. Moreover, the ground-truth about outliers is often unavailable, as in the case of unsupervised scenarios, hampering the use of quantitative methods to assess the effectiveness of the algorithms in a rigorous way. The analyst is left with the alternative of qualitative and intuitive evaluation of results [2]. To overcome this difficulty, we will use in this chapter logistic regression models to investigate the performance of different outlier identification techniques in the medically relevant case study.

## 14.2 Part 1—Theoretical Concepts

Outlier identification methods can be classified into supervised and unsupervised methods, depending on whether prior information about the abnormalities in the data is available or not. The techniques can be further divided into univariable and multivariable methods, conditional on the number of variables considered in the dataset of interest.

The simplest form of outlier detection is extreme value analysis of unidimensional data. In this case, the core principle of discovering outliers is to determine the statistical tails of the underlying distribution and assume that either too large or too small values are outliers. In order to apply this type of technique to a multidimensional dataset, the analysis is performed one dimension at a time. In such a multivariable analysis, outliers are samples which have unusual combinations with other samples in the multidimensional space. It is possible to have outliers with reasonable marginal values (i.e. the value appears normal when confining oneself to one dimension), but due to linear or non-linear combinations of multiple attributes



**Fig. 14.1** Univariable (*boxplots*) versus multivariable (*scatter plot*) outlier investigation

these observations unveil unusual patterns in regards to the rest of the population under study.

To better understand this, the Fig. 14.1 provides a graphical example of a scenario where outliers are only visible in a 2-dimensional space. An inspection of the boxplots will reveal no outliers (no data point above and below 1.5 IQR (the interquartile range, refer to Chap. 15—Exploratory Data Analysis), a widely utilized outlier identification method), whereas a close observation of the natural clusters present in data will uncover irregular patterns. Outliers can be identified by visual inspection, highlighting data points that seem to be relatively out of the inherent 2-D data groups.

### 14.3 Statistical Methods

In the field of statistics, the data is assumed to follow a distribution model (e.g., normal distribution) and an instance is considered an outlier if it deviates significantly from the model [2, 4]. The use of normal distributions simplifies the analysis,

as most of the existing statistical tests, such as the Z-score, can be directly interpreted in terms of probabilities of significance. However, in many real world datasets the underlying distribution of the data is unknown or complex. Statistical tests still provide a good approximation of outlier scores, but results of the tests need to be interpreted carefully and cannot be expressed statistically [2]. The next sections describe some of the most widely used statistical tests for outliers identification.

### 14.3.1 Tukey's Method

Quartiles are the values that divide an array of numbers into quarters. The (IQR) is the distance between the lower (Q1) and upper (Q3) quartiles in the boxplot, that is  $IQR = Q3 - Q1$ . It can be used as a measure of how spread out the values are. Inner “fences” are located at a distance of  $1.5 IQR$  below Q1 and above Q3, and outer fences at a distance of  $3 IQR$  below Q1 and above Q3 [5]. A value between the inner and outer fences is a possible outlier, whereas a value falling outside the outer fences is a probable outlier. The removal of all possible and probable outliers is referred to as the Interquartile (IQ) method, while in Tukey's method only the probable outliers are discarded.

### 14.3.2 Z-Score

The Z-value test computes the number of standard deviations by which the data varies from the mean. It presents a reasonable criterion for the identification of outliers when the data is normally distributed. It is defined as:

$$z_i = \frac{x_i - \bar{x}}{s} \quad (14.1)$$

where  $\bar{x}$  and  $s$  denote the sample mean and standard deviation, respectively. In cases where mean and standard deviation of the distribution can be accurately estimated (or are available from domain knowledge), a good “rule of thumb” is to consider values with  $|z_i| \geq 3$  as outliers. Of note, this method is of limited value for small datasets, since the maximum z-score is at most  $n - 1/\sqrt{n}$  [6].

### 14.3.3 Modified Z-Score

The estimators used in the z-Score, the sample mean and sample standard deviation, can be affected by the extreme values present in the data. To avoid this problem, the



modified z-score uses the median  $\tilde{x}$  and the median absolute deviation (MAD) instead of the mean and standard deviation of the sample [7]:

$$M_i = \frac{0.6745(x_i - \tilde{x})}{MAD} \quad (14.2)$$

where

$$MAD = \text{median}\{|x_i - \tilde{x}|\} \quad (14.3)$$

The authors recommend using modified z-scores with  $|M_i| \geq 3.5$  as potential outliers. The assumption of normality of the data still holds.

### 14.3.4 Interquartile Range with Log-Normal Distribution

The statistical tests discussed previously are specifically based on the assumption that the data is fairly normally distributed. In the health care domain it is common to find skewed data, for instance in surgical procedure times or pulse oxymetry [8]. Refer to Chap. 15-Exploratory Data Analysis for a formal definition of skewness. If a variable follows a log-normal distribution then the logarithms of the observations follow a normal distribution. A reasonable approach then is to apply the  $\ln$  to the original data and they apply the tests intended to the “normalized” distributions. We refer to this method as the log-IQ.

### 14.3.5 Ordinary and Studentized Residuals

In a linear regression model, ordinary residuals are defined as the difference between the observed and predicted values. Data points with large residuals differ from the general regression trend and may represent outliers. The problem is that their magnitudes depend on their units of measurement, making it difficult to, for example, define a threshold at which a point is considered an outlier. Studentized residuals eliminate the units of measurement by dividing the residuals by an estimate of their standard deviation. One limitation of this approach is it assumes the regression model is correctly specified.

### 14.3.6 Cook’s Distance

In a linear regression model, Cook’s distance is used to estimate the influence of a data point on the regression. The principle of Cook’s distance is to measure the

effect of deleting a given observation. Data points with a large distance may represent outliers. For the  $i$ th point in the sample, Cook's distance is defined as:

$$D_i = \frac{\sum_{j=1}^n (\hat{y}_j \hat{y}_{j(i)})^2}{(k+1)s^2} \quad (14.4)$$

Where  $\hat{y}_{j(i)}$  is the prediction of  $y_j$  by the revised regression model when the  $i$ th point is removed from the sample, and  $s$  is the estimated root mean square error. Instinctively,  $D_i$  is a normalized measure of the influence of the point  $i$  on all predicted mean values  $\hat{y}_j$  with  $j = 1, \dots, n$ . Different cut-off values can be used for flagging highly influential points. Cook has suggested that a distance  $>1$  represents a simple operational guideline [9]. Others have suggested a threshold of  $4/n$ , with  $n$  representing the number of observations.

### 14.3.7 Mahalanobis Distance

This test is based on Wilks method designed to detect a single outlier from a normal multivariable sample. It approaches the maximum squared Mahalanobis Distance (MD) to an  $F$ -distribution function formulation, which is often more appropriate than a  $\chi^2$  distribution [10]. For a  $p$ -dimensional multivariate sample  $x_i$  ( $i = 1, \dots, n$ ), the Mahalanobis distance of the  $i$ th case is defined as:

$$MD_i = \sqrt{(x_i - t)^T C^{-1} (x_i - t)} \quad (14.5)$$

where  $t$  is the estimated multivariate location, which is usually the arithmetic mean, and  $C$  is the estimated covariance matrix, usually the sample covariance matrix.

Multivariate outliers can be simply defined as observations having a large squared Mahalanobis distance. In this work, the squared Mahalanobis distance is compared with quantiles of the  $F$ -distribution with  $p$  and  $p - 1$  degrees of freedom. Critical values are calculated using Bonferroni bounds.

## 14.4 Proximity Based Models

Proximity-based techniques are simple to implement and unlike statistical models they make no prior assumptions about the data distribution model. They are suitable for both supervised and unsupervised multivariable outlier detection [4].

Clustering is a type of proximity-based technique that starts by partitioning a  $N$ -dimensional dataset into  $c$  subgroups of samples (clusters) based on their similarity. Then, some measure of the fit of the data points to the different clusters is used in order to determine if the data points are outliers [2]. One challenge associated with

this type of technique is that it assumes specific shapes of clusters depending on the distance function used within the clustering algorithm. For example, in a 3-dimensional space, the Euclidean distance would consider spheres as equidistant, whereas the Mahalanobis distance would consider ellipsoids as equidistant (where the length of the ellipsoids in one axis is proportional to the variance of the data in that direction).

### ***14.4.1 k-Means***

The k-means algorithm is widely used in data mining due to its simplicity and scalability [11]. The difficulty associated with this algorithm is the need to determine  $k$ , the number of clusters, in advance. The algorithm minimizes the within-cluster sum of squares, the sum of distances between each point in a cluster and the cluster centroid. In k-means, the center of a group is the mean of measurements in the group. Metrics such as the Akaike Information Criterion or the Bayesian Information Criterion, which add a factor proportional to  $k$  to the cost function used during clustering, can help determine  $k$ . A  $k$  value which is too high will increase the cost function even if it reduces the within-cluster sum of squares [12, 13].

### ***14.4.2 k-Medoids***

Similarly to k-means, the k-medoids clustering algorithm partitions the dataset into groups so that it minimizes the sum of distances between a data point and its center. In contrast to the k-means algorithm, in k-medoids the cluster centers are members of the group. Consequently, if there is a region of outliers outside the area with higher density of points, the cluster center will not be pushed towards the outliers region, as in k-means. Thus, k-medoids is more robust towards outliers than k-means.

### ***14.4.3 Criteria for Outlier Detection***

After determining the position of the cluster center with either k-means or k-medoids, the criteria to classify an item as an outlier must be specified, and different options exist:

Criterion 1: The first criterion proposed to detect outliers is based on the Euclidean distance to the cluster centers  $C$ , such that points more distant to their center than the minimum interclusters distance are considered outliers:

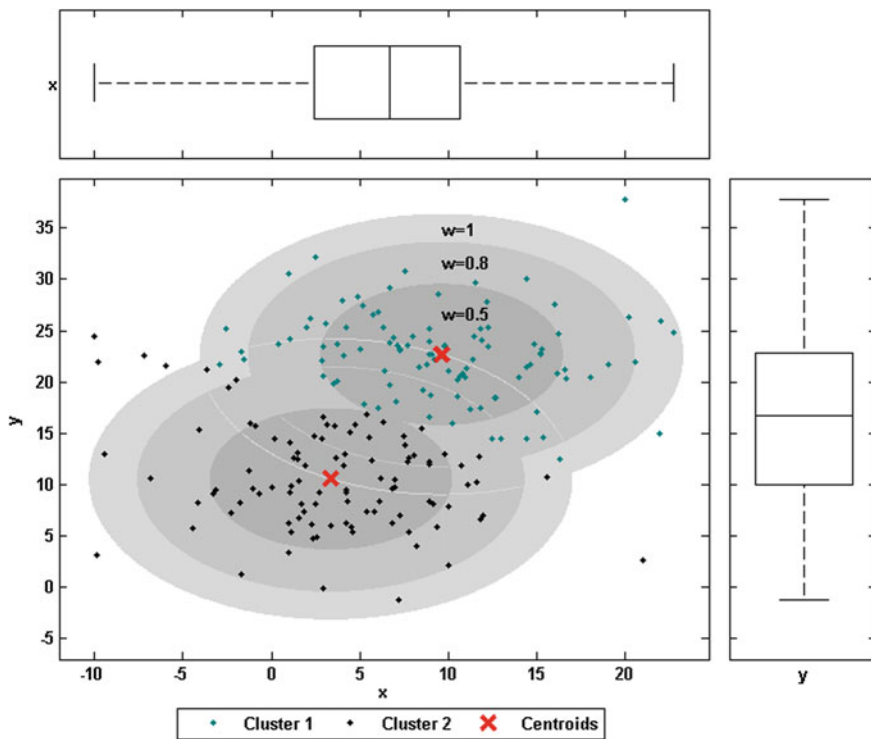


Fig. 14.2 Effect of different weights  $w$  in the detection of cluster-based outliers, using criterion 1

$$x \in C_k \text{ is outlier if } d(x, C_k) > \min_{k \neq j} \{ \delta(C_k, C_j) \} \times w \quad (14.6)$$

where  $d(x, C_k)$  is the Euclidean distance between point  $x$  and  $C_k$  center,  $\delta(C_k, C_j)$  is the distance between  $C_k$  and  $C_j$  centers and  $w = \{0.5, 0.7, 1, 1.2, 1.5, \dots\}$  is a weighting parameter that determines how aggressively the method will remove outliers.

Figure 14.2 provides a graphical example of the effect of varying values of  $w$  in the creation of boundaries for outlier detection. While small values of  $w$  aggressively remove outliers, as  $w$  increases the harder it is to identify them.

Criterion 2: In this criterion, we calculate the distance of each data point to its centroid (case of k-means) or medoid (case of k-medoids) [14]. If the ratio of the distance of the nearest point to the cluster center and these calculated distances are smaller than a certain threshold, than the point is considered an outlier. The threshold is defined by the user and should depend on the number of clusters selected, since the higher the number of clusters the closer are the points inside the cluster, i.e., the threshold should decrease with increasing  $c$ .

## 14.5 Supervised Outlier Detection

In many scenarios, previous knowledge about outliers may be available and can be used to label the data accordingly and to identify outliers of interest. The methods relying on previous examples of data outliers are referred to as supervised outlier detection methods, and involve training classification models which can later be used to identify outliers in the data. Supervised methods are often devised for anomaly detection in application domains where anomalies are considered occurrences of interest. Examples include fraud control, intrusion detection systems, web robot detection or medical diagnosis [1]. Hence, the labels represent what an analyst might be specifically looking for rather than what one might want to remove [2]. The key difference comparing to many other classification problems is the inherent unbalanced nature of data, since instances labeled as “abnormal” are present much less frequently than “normal” labeled instances. Interested readers can find further information about this topic in the textbook by Aggarwal, for instance [2].

## 14.6 Outlier Analysis Using Expert Knowledge

In univariate analyses, expert knowledge can be used to define thresholds of values that are normal, critical (life-threatening) or impossible because they fall outside permissible ranges or have no physical meaning [15]. Negative measurements of heart rate or body temperatures are examples of impossible values. It is very important to check the dataset for these types of outliers, as they originated undoubtedly from human error or equipment malfunction, and should be deleted or corrected.

## 14.7 Case Study: Identification of Outliers in the Indwelling Arterial Catheter (IAC) Study

In this section, various methods will be applied to identify outliers in two “real world” clinical datasets used in a study that investigated the effect of inserting an indwelling arterial catheter (IAC) in patients with respiratory failure. Two datasets are used, and include patients that received an IAC (IAC group) and patients that did not (non-IAC). The code used to generate the analyses and the figures is available in the GitHub repository for this book.

**Table 14.1** Normal, critical and impossible ranges for the selected variables, and maximum and minimum values present in the datasets

Variable	Reference value			Analyzed data		
	Normal range	Critical	Impossible	IAC	Non-IAC	Units
Age	–	–	<17 (adults)	15.2–99.1	15.2–97.5	Years
SOFA	–	–	<0 and >24	1–17	0–14	No units
WBC	3 9–10.7	$\geq 100$	<0	0.3–86.0	0 2–109.8	$\times 10^9$ cells/L
Hemoglobin	Male: 13.5–17.5	$\leq 6$ and $\geq 20$	<0	Male: 3 2–19.0	4.9–18.6	g/dL
	Female: 12–16			Female: 2.0–18.1		
Platelets	150–400	$\leq 40$ and $\geq 1000$	<0	7.0–680.0	9.0–988.0	$\times 10^9$ /L
Sodium	136–145	$\leq 120$ and $\geq 160$	<0	105 0–165.0	111.0–154.0	mmol/L
Potassium	3.5–5	$\leq 2.5$ and $\geq 6$	<0	1 9–9.8	1.9–8.3	mmol/L
TCO <sub>2</sub>	22–28	$\leq 10$ and $\geq 40$ [4]	<0	2.0–62.0	5.0–52.0	mmol/L
Chloride [29]	95–105	$\leq 70$ and $\geq 120$	<0 and $\geq 160$	81.0–133.0	78.0–127.0	mmol/L
BUN	7–18	$\geq 100$ [1]	<0	2.0–139.0	2.0–126.0	mg/dL
Creatinine	0.6–1.2	$\geq 10$	<0	0.2–12 5	0.0–18.3	mg/dL
PO <sub>2</sub>	75–105	$\leq 40$	<0	25 0–594.0	22.0–634.0	mmHg
PCO <sub>2</sub>	33–45	$\leq 20$ and $\geq 70$	<0	8.0–141.0	14.0–158.0	mmHg

## 14.8 Expert Knowledge Analysis

Table 14.1 provides maximum and minimum values for defining normal, critical and permissible ranges in some of the variables analyzed in the study, as well as maximum and minimum values present in the dataset.

## 14.9 Univariate Analysis

In this section, univariate outliers are identified for each variable within pre-defined classes (survivors and non-survivors), using the statistical methods described above.

Table 14.2 summarizes the number and percentage of outliers identified by each method in the Indwelling Arterial Catheter (IAC) and non-IAC groups. Overall, Tukey's and log-IQ are the most conservative methods, i.e., they identify the

**Table 14.2** Number and percentage of outliers identified by each method

	IAC									
	Class 0 (811 patients)					Class 1 (163 patients)				
	IQ	Tukey's	log-IQ	Z-score	Mod z-score	IQ	Tukey's	Log-IQ	Z-score	Mod z-score
Age	0 (0.0 %)	0 (0.0 %)	1 (0.1 %)	0 (0.0 %)	0 (0.0 %)	5 (0.6 %)	0 (0.0 %)	8 (1.0 %)	4 (0.5 %)	5 (0.6 %)
SOFA	13 (1.6 %)	0 (0.0 %)	6 (0.7 %)	2 (0.2 %)	20 (2.5 %)	<b>16 (2.0 %)</b>	3 (0.4 %)	8 (1.0 %)	1 (0.1 %)	5 (0.6 %)
WBC	20 (2.5 %)	3 (0.4 %)	21 (2.6 %)	5 (0.6 %)	10 (1.2 %)	6 (0.7 %)	1 (0.1 %)	5 (0.6 %)	1 (0.1 %)	3 (0.4 %)
Hemoglobin	8 (1.0 %)	1 (0.1 %)	13 (1.6 %)	5 (0.6 %)	4 (0.5 %)	0 (0.0 %)	0 (0.0 %)	0 (0.0 %)	0 (0.0 %)	0 (0.0 %)
Platelets	17 (2.1 %)	1 (0.1 %)	36 (4.4 %)	7 (0.9 %)	7 (0.9 %)	4 (0.5 %)	0 (0.0 %)	2 (0.2 %)	2 (0.2 %)	1 (0.1 %)
Sodium	30 (3.7 %)	8 (1.0 %)	30 (3.7 %)	10 (1.2 %)	26 (3.2 %)	8 (1.0 %)	1 (0.1 %)	8 (1.0 %)	2 (0.2 %)	2 (0.2 %)
Potassium	39 (4.8 %)	10 (1.2 %)	35 (4.3 %)	14 (1.7 %)	26 (3.2 %)	9 (1.1 %)	1 (0.1 %)	7 (0.9 %)	2 (0.2 %)	8 (1.0 %)
TCO <sub>2</sub>	24 (3.0 %)	4 (0.5 %)	31 (3.8 %)	13 (1.6 %)	13 (1.6 %)	9 (1.1 %)	1 (0.1 %)	6 (0.7 %)	2 (0.2 %)	2 (0.2 %)
Chloride	21 (2.6 %)	3 (0.4 %)	24 (3.0 %)	13 (1.6 %)	18 (2.2 %)	4 (0.5 %)	0 (0.0 %)	3 (0.4 %)	1 (0.1 %)	1 (0.1 %)
BUN	<b>72 (8.9 %)</b>	<b>37 (4.6 %)</b>	<b>48 (5.9 %)</b>	<b>20 (2.5 %)</b>	<b>60 (7.4 %)</b>	13 (1.6 %)	<b>9 (1.1 %)</b>	7 (0.9 %)	<b>5 (0.6 %)</b>	<b>13 (1.6 %)</b>
Creatinine	50 (6.2 %)	31 (3.8 %)	43 (5.3 %)	18 (2.2 %)	40 (4.9 %)	11 (1.4 %)	2 (0.2 %)	2 (0.2 %)	2 (0.2 %)	8 (1.0 %)
PO <sub>2</sub>	0 (0.0 %)	0 (0.0 %)	2 (0.2 %)	0 (0.0 %)	0 (0.0 %)	0 (0.0 %)	0 (0.0 %)	0 (0.0 %)	0 (0.0 %)	0 (0.0 %)
PCO <sub>2</sub>	53 (6.5 %)	22 (2.7 %)	<b>48 (5.9 %)</b>	19 (2.3 %)	37 (4.6 %)	11 (1.4 %)	4 (0.5 %)	<b>13 (1.6 %)</b>	4 (0.5 %)	9 (1.1 %)
Total patients	<b>220 (27.1 %)</b>	86(10.6 %)	210 (25.9 %)	91 (11.2 %)	165 (20.3 %)	<b>63 (7.8 %)</b>	20 (2.5 %)	47 (5.8 %)	23 (2.8 %)	43 (5.3 %)
	Non-IAC									
	Class 0 (524 patients)					Class 1 (83 patients)				
	IQ	Tukey's	log-IQ	Z-score	Mod z-score	IQ	Tukey's	Log-IQ	Z-score	Mod z-score
Age	0 (0.0 %)	0 (0.0 %)	0 (0.0 %)	0 (0.0 %)	0 (0.0 %)	1 (0.2 %)	0 (0.0 %)	3 (0.6 %)	1 (0.2 %)	1 (0.2 %)
SOFA	<b>51 (9.7 %)</b>	2 (0.4 %)	<b>48 (9.2 %)</b>	2 (0.4 %)	7 (1.3 %)	<b>9 (1.7 %)</b>	1 (0.2 %)	8 (1.5 %)	1 (0.2 %)	3 (0.6 %)
WBC	21 (4.0 %)	4 (0.8 %)	10 (1.9 %)	4 (0.11 %)	11 (2.1 %)	4 (0.8 %)	1 (0.2 %)	4 (0.8 %)	1 (0.2 %)	3 (0.6 %)
Hemoglobin	1 (0.4 %)	0 (0.0 %)	6 (1.1 %)	2 (0.4 %)	2 (0.4 %)	0 (0.0 %)	0 (0.0 %)	2 (0.4 %)	0 (0.0 %)	0 (0.0 %)

(continued)

**Table 14.2** (continued)

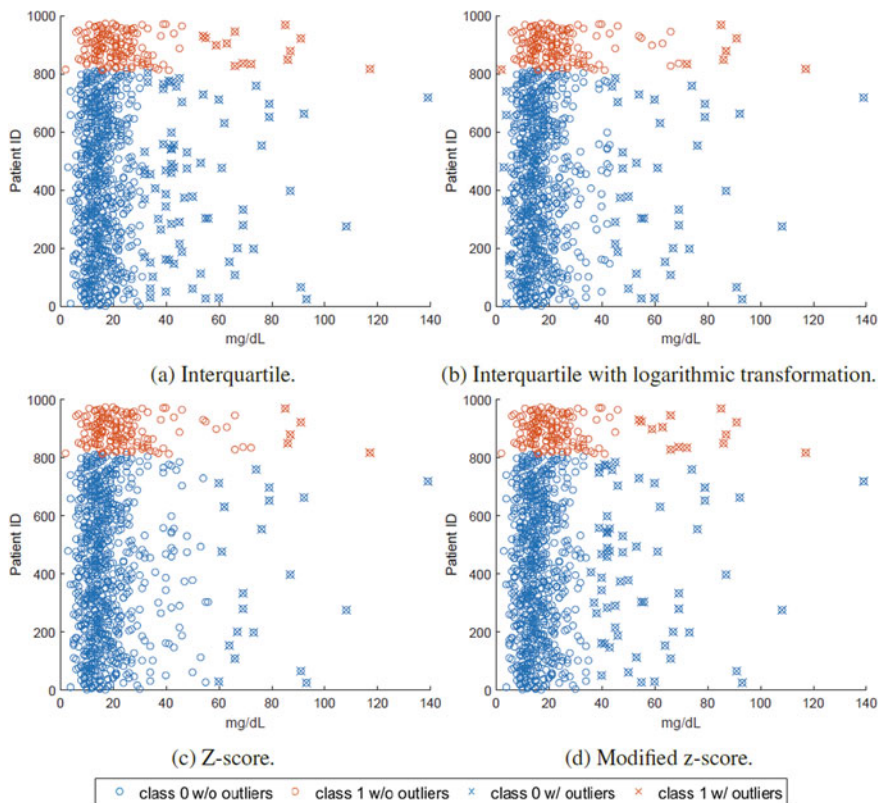
	Non-IAC						Class 1 (83 patients)					
	Class 0 (524 patients)						Class 1 (83 patients)					
	IQ	Tukey's	log-IQ	Z-score	Mod z-score	IQ	Tukey's	Log-IQ	Z-score	Mod z-score	Mod z-score	
Platelets	15 (2.9 %)	5 (1.0 %)	21 (4.0 %)	5 (1.0 %)	6 (1.1 %)	4 (0.8 %)	1 (0.2 %)	5 (1.0 %)	<b>2 (0.4 %)</b>	2 (0.4 %)	2 (0.4 %)	
Sodium	25 (4.8 %)	9 (1.7 %)	25 (4.11 %)	9 (1.7 %)	20 (3.11 %)	5 (1.0 %)	1 (0.2 %)	5 (1.0 %)	1 (0.2 %)	1 (0.2 %)	1 (0.2 %)	
Potassium	22 (4.2 %)	2 (0.4 %)	14 (2.7 %)	6 (1.1 %)	14 (2.7 %)	1 (0.2 %)	0 (0.0 %)	0 (0.0 %)	0 (0.0 %)	0 (0.0 %)	0 (0.0 %)	
TCO <sub>2</sub>	27 (5.2 %)	4 (0.8 %)	31 (5.9 %)	8 (1.5 %)	5 (1.0 %)	4 (0.8 %)	1 (0.2 %)	4 (0.8 %)	<b>2 (0.4 %)</b>	3 (0.6 %)	3 (0.6 %)	
Chloride	21 (4.0 %)	4 (0.8 %)	20 (3.11 %)	9 (1.7 %)	11 (2.1 %)	<b>9 (1.7 %)</b>	1 (0.2 %)	<b>9 (1.7 %)</b>	1 (0.2 %)	4 (0.8 %)	4 (0.8 %)	
BUN	35 (6.7 %)	<b>20 (3.8 %)</b>	27 (5.2 %)	<b>13 (2.5 %)</b>	<b>34 (6.5 %)</b>	6 (1.1 %)	2 (0.4 %)	2 (0.4 %)	<b>2 (0.4 %)</b>	6 (1.1 %)	6 (1.1 %)	
Creatinine	29 (5.5 %)	17 (3.2 %)	25 (4.8 %)	8 (1.5 %)	22 (4.2 %)	7 (1.3 %)	2 (0.4 %)	3 (0.6 %)	<b>2 (0.4 %)</b>	5 (1.0 %)	5 (1.0 %)	
PO <sub>2</sub>	0 (0.0 %)	0 (0.0 %)	0 (0.0 %)	0 (0.0 %)	0 (0.0 %)	1 (0.2 %)	0 (0.0 %)	0 (0.0 %)	0 (0.0 %)	3 (0.6 %)	3 (0.6 %)	
PCO <sub>2</sub>	34 (6.5 %)	11 (2.1 %)	33 (6.3 %)	10 (1.9 %)	28 (5.3 %)	8 (1.5 %)	<b>4 (0.8 %)</b>	6 (1.1 %)	<b>2 (0.4 %)</b>	<b>8 (1.5 %)</b>	<b>8 (1.5 %)</b>	
Total patients	<b>176 (33.6 %)</b>	59 (11.3 %)	172 (32.8 %)	56 (10.7 %)	111 (21.2 %)	<b>37 (7.1 %)</b>	11 (2.1 %)	29 (5.5 %)	11 (2.1 %)	28 (5.3 %)	28 (5.3 %)	

“Total patients” represents the number of patients identified when considering all variables together. The results in bold highlight the variable with the most outliers in each method, and also the method that removes more patients in total, in each class. Class 0: represents survivors, Class 1: non-survivors

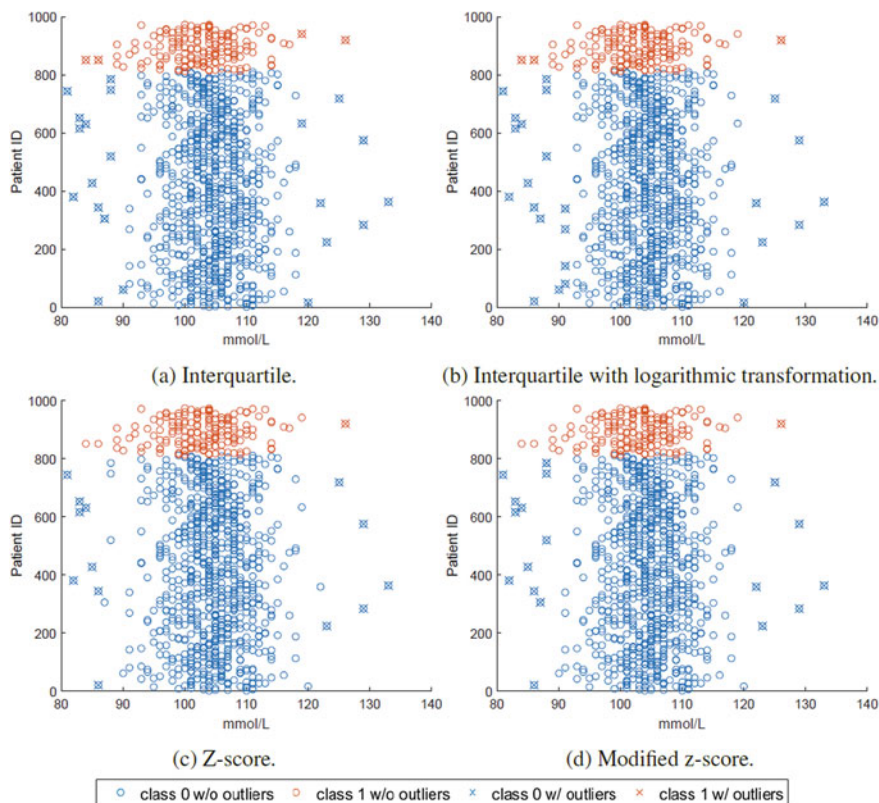


smallest number of points as outliers, whereas IQ identifies more outliers than any other method. With a few exceptions, the modified z-score identifies more outliers than the z-score.

A preliminary investigation of results showed that values falling within reference normal ranges (see Table 14.1) are never identified as outliers, whatever the method. On the other hand, critical values are often identified as such. Additional remarks can be made as in general (1) more outliers are identified in the variable BUN than in any other and (2) the ratio of number of outliers and total number of patients is smaller in the class 1 cohorts (non-survivors). As expected, for variables that approximate more to lognormal distribution than to a normal distribution, such as potassium, BUN and PCO<sub>2</sub>, the IQ method applied to the logarithmic transformation of data (log-IQ method) identifies less outliers than the IQ applied to the real data. Consider for instance the variable BUN, which follows approximately a lognormal distribution. Figure 14.3 shows a scatter of all data points and the identified outliers in the IAC group.



**Fig. 14.3** Outliers identified by statistical analysis for the variable BUN, in the IAC cohort. Class 0: survivors; Class 1: non survivors



**Fig. 14.4** Outliers identified by statistical analysis for the variable chloride, in the IAC cohort. Class 0: survivors; Class 1: non survivors

On the other hand, when the values follow approximately a normal distribution, as in the case of chloride (see Fig. 14.4), the IQ method identifies less outliers than log-IQ. Of note, the range of values considered outliers differs between classes, i.e., what is considered an outlier in class 0 is not necessarily an outlier in class 1. An example of this is values smaller than 90 mmol/L in the modified z-score.

Since this is a univariate analysis, the investigation of extreme values using expert knowledge is of interest. For chloride, normal values are in the range of 95–105 mmol/L, whereas values <70 or >120 mmol/L are considered critical, and concentrations above 160 mmol/L are physiologically impossible [15]. Figure 14.4 confirms that normal values are always kept, whatever the method. Importantly, some critical values are not identified in both z-score and modified z-score (especially in class 1). Thus, it seems that the methods identify outliers that should not be eliminated, as they likely represent actual values in extremely sick patients.

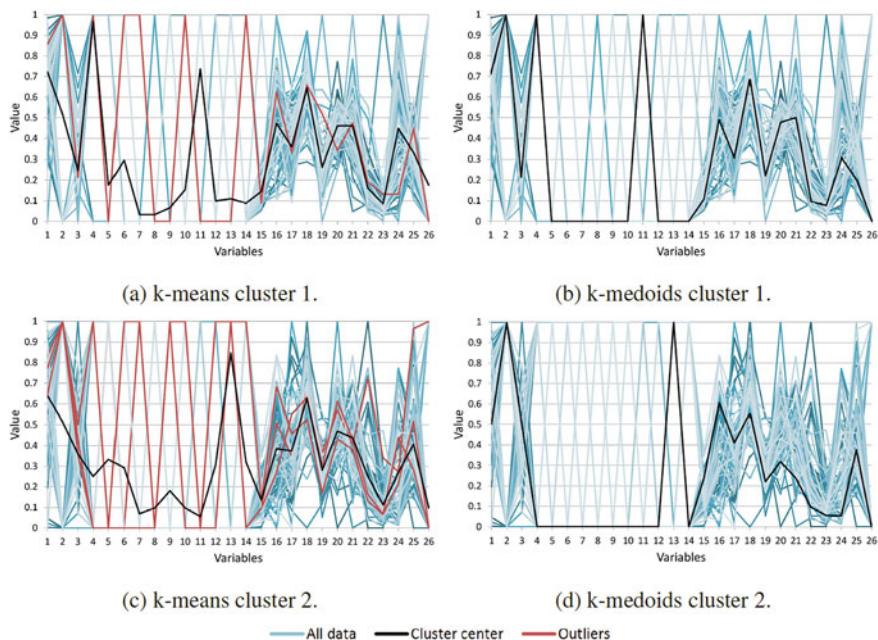
### 14.10 Multivariable Analysis

Using model based approaches, unusual combination of values for a number of variables can be identified. In this analysis we will be concerned with multivariable outliers for the complete set of variables in the datasets, including those that are binary. In order to investigate multivariable outliers in IAC and non-IAC patients, the Mahalanobis distance and cluster based approaches are tested within pre-defined classes. Table 14.3 shows the average results in terms of number of clusters  $c$  determined by the silhouette index, and the percentage of patients identified as

**Table 14.3** Multivariable outliers identified by k-means, k-medoids and Mahalanobis distance

	Criterion	Weight	$c$		% of outliers Class 0	
			Class 0	Class 1	Class 0	Class 1
<i>IAC</i>						
K-means, silhouette index	1	1.2	4 ± 3.1	2 ± 0.0	25.2 ± 7.4	20.9 ± 11.0
	1	1.5	3 ± 2.9	2 ± 0.0	7.9 ± 4.6	3.3 ± 5.9
	1	1.7	3 ± 2.6	2 ± 0.0	3.6 ± 2.5	0.4 ± 2.2
	1	2.0	4 ± 3.1	2 ± 0.0	1.0 ± 1.1	0.1 ± 0.3
K-means, $c = 2$	2	0.05	2 ± 0.0	2 ± 0.0	28.5 ± 4.8	21.4 ± 11.9
	2	0.06	2 ± 0.0	2 ± 0.0	9.3 ± 4.2	2.9 ± 5.2
K-medoids, silhouette index	1	1.2	4 ± 3.0	2 ± 0.0	4.1 ± 2.2	0.8 ± 3.1
	1	1.5	3 ± 2.6	2 ± 0.0	1.1 ± 1.0	0.1 ± 0.3
	1	1.7	3 ± 2.9	2 ± 0.0	0.2 ± 0.2	0.0 ± 0.0
	1	2.0	4 ± 3.0	2 ± 0.0	0.7 ± 0.4	0.0 ± 0.0
K-medoids, $c = 2$	2	0.01	2 ± 0.0	2 ± 0.0	34.6 ± 8.6	2.5 ± 0.0
	2	0.02	2 ± 0.0	2 ± 0.0	20.8 ± 6.1	0.0 ± 0.0
Mahalanobis	–	–	–	–	16.7 ± 5.5	0.0 ± 0.0
<i>Non-IAC</i>						
K-means, silhouette index	1	1.2	9 ± 1.8	7 ± 2.4	12.8 ± 4.1	13.0 ± 9.5
	1	1.5	9 ± 1.7	7 ± 2.5	2.8 ± 1.8	1.0 ± 1.7
	1	1.7	9 ± 1.8	7 ± 2.5	0.9 ± 1.2	0.0 ± 0.2
	1	2.0	9 ± 2.4	7 ± 2.5	0.2 ± 0.7	0.0 ± 0.0
K-means, $c = 2$	2	0.05	2 ± 0.0	2 ± 0.0	25.5 ± 4.5	41.0 ± 11.9
	2	0.06	2 ± 0.0	2 ± 0.0	10.6 ± 2.6	4.8 ± 7.2
K-medoids, silhouette index	1	1.2	9 ± 1.5	7 ± 2.5	3.8 ± 1.6	1.4 ± 1.6
	1	1.5	9 ± 2.0	7 ± 2.4	0.9 ± 1.9	0.0 ± 0.0
	1	1.7	9 ± 2.0	7 ± 2.4	0.3 ± 0.6	0.0 ± 0.0
	1	2.0	9 ± 1.3	7 ± 2.5	0.4 ± 0.9	0.0 ± 0.0
K-medoids, $c = 2$	2	0.01	2 ± 0.0	2 ± 0.0	19.7 ± 4.0	2.7 ± 8.8
	2	0.02	2 ± 0.0	2 ± 0.0	11.0 ± 2.8	1.0 ± 5.0
Mahalanobis	–	–	–	–	6.8 ± 2.6	0.8 ± 4.0

Results are presented as mean ± standard deviation



**Fig. 14.5** Outliers identified by clustering based approaches for patients that died after IAC. Criterion 1, based on interclusters distance, with  $c = 2$  and  $w = 1.5$  was used. K-medoids does not identify outliers, whereas k-means identifies 1 outlier in cluster 1 and 2 outliers in cluster 2

outliers. In order to account for variability, the tests were performed 100 times. The data was normalized for testing the cluster based approaches only.

Considering the scenario where two clusters are created for the complete IAC dataset separated by classes, we investigate outliers by looking at multivariable observations around cluster centers. Figure 14.5 shows an example of the outliers detected using k-means and k-medoids with the criterion 1 and weight equal to 1.5. For illustrative purposes, we present only the graphical results of patients that died in the IAC group (class 1). The x-axis represents each of the selected features (see Table 14.1) and the y-axis represents the corresponding values normalized between 0 and 1. K-medoids does not identify any outlier, whereas k-means identifies 1 outlier in the first cluster and 2 outliers in the second cluster. This difference can be attributed to the fact that the intercluster distance is smaller in k-medoids than in k-means.

The detection of outliers seems to be more influenced by binary features than by continuous features: red lines are, with some exceptions, fairly close to black lines for the continuous variables (1 to 2 and 15 to 25) and distant in the binary variables. A possible explanation is that clustering was essentially designed for multivariable continuous data; binary variables produce a maximum separation, since only two values exist, 0 and 1, with nothing between them.

## 14.11 Classification of Mortality in IAC and Non-IAC Patients

Logistic regression models were created to assess the effect of removing outliers using the different methods in the classification of mortality in IAC and non-IAC patients, following the same rationale as in Chap. 13-Missing Data. A 10-fold cross validation approach was used to assess the validity and robustness of the models. In each round, every outlier identification method was applied separately for each class of the training set, and the results were averaged over the rounds. Before cross-validation, the values were normalized between 0 and 1 using the min-max procedure. For the log-IQ method, the data was log-transformed before normalization, except for variables containing null values (binary variables in Table 14.1, SOFA and creatinine). We also investigate the scenario where only the 10 % worst examples detected by each statistical method within each class are considered, and the case where no outliers were removed (all data is used). In the clustering based approaches, the number of clusters  $c$  was chosen between 2 and 10 using the silhouette index method. We also show the case where  $c$  is fixed as 2. The weight of the clustering based approaches was adjusted according to the particularities of the method. Since a cluster center in k-medoids is a data point belonging to the dataset, the distance to its nearest neighbor is smaller than in the case of k-means, especially because a lot of binary variables are considered. For this reason, we chose higher values of  $w$  for k-means criterion 2.

The performance of the models is evaluated in terms of area under the receiver operating characteristic curve (AUC), accuracy (ACC, correct classification rate), sensitivity (true positive classification rate), and specificity (true negative classification rate). A specific test suggested by DeLong and DeLong can then test whether the results differ significantly [16].

The performance results for the IAC group are shown in Table 14.4, and the percentage of patients removed using each method in Table 14.5. For conciseness, the results for the non-IAC group are not shown. The best performance for IAC is  $AUC = 0.83$  and  $ACC = 0.78$  (highlighted in bold). The maximum sensitivity is 87 % and maximum specificity is 79 %, however these two do not occur simultaneously. Overall, the best AUC is obtained when all the data is used and when only a few outliers are removed. The worst performances are obtained using the z-score without trimming the results and k-means and k-medoids using  $c = 2$ , criterion 1 and weight 1.2. As for non-IAC, the best performance corresponds to  $AUC = 0.88$ ,  $ACC = 0.84$ , sensitivity = 0.85 and specificity = 0.85. Again, the best performance is achieved when all the data is used and in the cases where less outliers are removed. The worst performance by far is obtained when all outliers identified by the z-score are removed. Similarly to IAC, for k-means and k-medoids criterion 1, increasing values of weight provide better results.

**Table 14.4** IAC logistic regression results using 10-fold cross validation, after removal of outliers and using the original dataset

Statistical	Cutoff	AUC	ACC	Sensitivity	Specificity
IQ	–	0.81 ± 0.05	0.76 ± 0.05	0.71 ± 0.14	0.76 ± 0.06
	10	0.82 ± 0.06	0.77 ± 0.06	0.76 ± 0.11	0.77 ± 0.07
Tukey’s	–	0.82 ± 0.05	0.75 ± 0.06	0.76 ± 0.09	0.75 ± 0.06
	10	<b>0.83 ± 0.06</b>	0.78 ± 0.05	0.75 ± 0.10	0.78 ± 0.06
Log-IQ	–	0.82 ± 0.06	0.76 ± 0.05	0.74 ± 0.14	0.76 ± 0.06
	10	<b>0.83 ± 0.06</b>	<b>0.78 ± 0.04</b>	0.73 ± 0.10	0.79 ± 0.05
Z-score	–	0.78 ± 0.03	0.67 ± 0.06	0.85 ± 0.09	0.64 ± 0.08
	10	0.81 ± 0.07	0.75 ± 0.06	0.74 ± 0.13	0.75 ± 0.07
Modified z-score	–	0.82 ± 0.05	0.76 ± 0.05	0.77 ± 0.14	0.76 ± 0.05
	10	0.82 ± 0.06	0.77 ± 0.06	0.75 ± 0.10	0.77 ± 0.06
Mahalanobis	–	0.81 ± 0.08	0.75 ± 0.06	0.73 ± 0.10	0.76 ± 0.07
Cluster based	Weight	AUC	ACC	Sensitivity	Specificity
K-means silhouette criterion 1	1.2	0.81 ± 0.08	0.72 ± 0.05	0.80 ± 0.12	0.70 ± 0.06
	1.5	0.82 ± 0.05	0.76 ± 0.06	0.76 ± 0.11	0.76 ± 0.06
	1.7	<b>0.83 ± 0.06</b>	<b>0.78 ± 0.05</b>	0.77 ± 0.10	0.78 ± 0.06
	2	<b>0.83 ± 0.06</b>	<b>0.78 ± 0.05</b>	0.74 ± 0.09	0.78 ± 0.06
K-means c = 2 criterion 1	1.2	0.79 ± 0.08	0.66 ± 0.05	0.84 ± 0.10	0.63 ± 0.06
	1.5	0.82 ± 0.06	0.73 ± 0.06	0.79 ± 0.09	0.72 ± 0.07
	1.7	0.82 ± 0.06	0.75 ± 0.06	0.78 ± 0.08	0.75 ± 0.08
	2	<b>0.83 ± 0.07</b>	<b>0.78 ± 0.06</b>	0.76 ± 0.09	0.78 ± 0.06
K-means criterion 2	0.05	<b>0.83 ± 0.07</b>	0.77 ± 0.05	0.74 ± 0.09	0.78 ± 0.06
	0.06	<b>0.83 ± 0.06</b>	0.77 ± 0.06	0.75 ± 0.10	0.78 ± 0.06
K-medoids silhouette criterion 1	1.2	0.81 ± 0.04	0.68 ± 0.04	0.85 ± 0.09	0.64 ± 0.05
	1.5	<b>0.83 ± 0.05</b>	0.74 ± 0.04	0.80 ± 0.10	0.73 ± 0.06
	1.7	<b>0.83 ± 0.05</b>	0.75 ± 0.06	0.78 ± 0.10	0.74 ± 0.07
	2	<b>0.83 ± 0.06</b>	0.77 ± 0.05	0.77 ± 0.09	0.77 ± 0.06
K-medoids c = 2 criterion 1	1.2	0.78 ± 0.06	0.62 ± 0.07	0.87 ± 0.08	0.57 ± 0.07
	1.5	0.81 ± 0.06	0.70 ± 0.06	0.83 ± 0.10	0.68 ± 0.08
	1.7	0.82 ± 0.06	0.72 ± 0.06	0.80 ± 0.10	0.71 ± 0.08
	2	<b>0.83 ± 0.07</b>	0.76 ± 0.06	0.77 ± 0.10	0.75 ± 0.07
K-medoids criterion 2	0.01	<b>0.83 ± 0.07</b>	0.74 ± 0.07	0.77 ± 0.10	0.74 ± 0.08
	0.02	0.81 ± 0.06	0.67 ± 0.06	0.85 ± 0.09	0.63 ± 0.08
All data	–	<b>0.83 ± 0.06</b>	<b>0.78 ± 0.05</b>	0.76 ± 0.11	0.79 ± 0.06

Results are presented as mean ± standard deviation

**Table 14.5** Percentage of IAC patients removed by each method in the train set, during cross-validation

Statistical	Cutoff	Class 0	Class 1	Total	
IQ	–	23.1 ± 1.4	33.3 ± 1.9	24.8 ± 1.4	
	10	3.3 ± 0.2	5.2 ± 0.3	3.6 ± 0.2	
Tukey’s	–	8.7 ± 0.05	10.1 ± 1.1	9.0 ± 0.5	
	10	1.2 ± 0.1	1.3 ± 0.2	1.3 ± 0.1	
Log-IQ	–	22.8 ± 1.1	25.4 ± 2.0	23.2 ± 1.1	
	10	3.1 ± 0.2	3.7 ± 0.5	3.2 ± 0.1	
Z-score	–	35.0 ± 1.6	0.67 ± 0.06	32.6 ± 1.4	
	10	5.3 ± 0.2	2.9 ± 1.3	4.9 ± 0.3	
Modified z-score	–	18.3 ± 0.05	24.5 ± 1.3	19.4 ± 0.5	
	10	2.4 ± 0.1	3.5 ± 0.4	2.6 ± 0.1	
Mahalanobis	–	19.6 ± 9.6	17.4 ± 3.0	19.2 ± 8.1	
Cluster based		Weight	Class 0	Class 1	Total
K-means silhouette criterion 1	1.2	19.6 ± 9.6	17.4 ± 3.0	19.2 ± 8.1	
	1.5	6.1 ± 5.1	1.9 ± 0.5	5.4 ± 4.2	
	1.7	2.5 ± 2.6	0.3 ± 0.3	2.2 ± 2.2	
	2	0.7 ± 0.9	0.0 ± 0.0	0.6 ± 0.8	
K-means $c = 2$ criterion 1	1.2	29.7 ± 3.5	17.4 ± 3.0	27.6 ± 2.9	
	1.5	11.9 ± 3.0	1.9 ± 0.5	10.2 ± 2.5	
	1.7	5.5 ± 2.0	0.3 ± 0.3	4.7 ± 1.6	
	2	1.7 ± 0.8	0.0 ± 0.0	1.4 ± 0.7	
K-means criterion 2	0.05	0.3 ± 0.2	0.0 ± 0.0	0.3 ± 0.2	
	0.06	1.1 ± 0.5	0.0 ± 0.0	0.9 ± 0.4	
K-medoids silhouette criterion 1	1.2	25.0 ± 10.7	3.8 ± 2.0	21.5 ± 8.8	
	1.5	12.9 ± 7.4	0.0 ± 0.0	10.8 ± 6.2	
	1.7	9.5 ± 6.1	0.0 ± 0.0	7.9 ± 5.1	
	2	3.1 ± 2.3	0.0 ± 0.0	2.5 ± 1.9	
K-medoids $c = 2$ criterion 1	1.2	34.7 ± 0.7	3.8 ± 2.0	29.5 ± 0.7	
	1.5	19.6 ± 0.6	0.0 ± 0.0	16.3 ± 0.5	
	1.7	14.9 ± 1.1	0.0 ± 0.0	12.4 ± 0.9	
	2	5.1 ± 0.4	0.0 ± 0.0	4.2 ± 0.4	
K-medoids criterion 2	0.01	8.3 ± 2.1	0.0 ± 0.0	6.9 ± 1.7	
	0.02	28.9 ± 3.9	1.8 ± 3.8	24.4 ± 3.6	

Results are presented as mean ± standard deviation

## 14.12 Conclusions and Summary

The univariable outlier analysis provided in the case study showed that a large number of outliers were identified for each variable within the predefined classes, meaning that the removal of all the identified outliers would cause a large portion of

data to be excluded. For this reason, ranking the univariate outliers according to score values and discarding only those with highest scores provided better classification results.

Overall, none of the outlier removal techniques was able to improve the performance of a classification model. As it had been cleaned these results suggest that the dataset did not contain impossible values, extreme values are probably due to biological variation rather than experimental mistakes. Hence, the “outliers” in this study appear to contain useful information in their extreme values, and automatically excluding resulted in a loss of this information.

Some modeling methods already accommodate for outliers so they have minimal impact in the model, and can be tuned to be more or less sensitive to them. Thus, rather than excluding outliers from the dataset before the modeling step, an alternative strategy would be to use models that are robust to outliers, such as robust regression.

### Take Home Messages

1. Distinguishing outliers as useful or uninformative is not clear cut.
2. In certain contexts, outliers may represent extremely valuable information that must not be discarded.
3. Various methods exist and will identify possible or likely outliers, but the expert eye must prevail before deleting or correcting outliers.

**Open Access** This chapter is distributed under the terms of the Creative Commons Attribution-NonCommercial 4.0 International License (<http://creativecommons.org/licenses/by-nc/4.0/>), which permits any noncommercial use, duplication, adaptation, distribution and reproduction in any medium or format, as long as you give appropriate credit to the original author(s) and the source, a link is provided to the Creative Commons license and any changes made are indicated.

The images or other third party material in this chapter are included in the work’s Creative Commons license, unless indicated otherwise in the credit line; if such material is not included in the work’s Creative Commons license and the respective action is not permitted by statutory regulation, users will need to obtain permission from the license holder to duplicate, adapt or reproduce the material.

### Code Appendix

The code used in this chapter is available in the GitHub repository for this book: <https://github.com/MIT-LCP/critical-data-book>. Further information on the code is available from this website.



## References

1. Barnett V, Lewis T (1994) *Outliers in statistical data*, 3rd edn. Wiley, Chichester
2. Aggarwal CC (2013) *Outlier analysis*. Springer, New York
3. Osborne JW, Overbay A (2004) The power of outliers (and why researchers should always check for them). *Pract Assess Res Eval* 9(6):1–12
4. Hodge VJ, Austin J (2004) A survey of outlier detection methodologies. *Artif Intell Rev* 22(2):85–126
5. Tukey J (1977) *Exploratory data analysis*. Pearson
6. Shiffler RE (1988) Maximum Z scores and outliers. *Am Stat* 42(1):79–80
7. Iglewicz B, Hoaglin DC (1993) *How to detect and handle outliers*. ASQC Quality Press
8. Seo S (2006) A review and comparison of methods for detecting outliers in univariate data sets. 09 Aug 2006 [Online]. Available: <http://d-scholarship.pitt.edu/7948/>. Accessed 07-Feb-2016
9. Cook RD, Weisberg S (1982) *Residuals and influence in regression*. Chapman and Hall, New York
10. Penny KI (1996) Appropriate critical values when testing for a single multivariate outlier by using the Mahalanobis distance. *Appl Stat* 45(1):73–81
11. Macqueen J (1967) Some methods for classification and analysis of multivariate observations. Presented at the proceedings of 5th Berkeley symposium on mathematical statistics and probability, pp 281–297
12. Hu X, Xu L (2003) A comparative study of several cluster number selection criteria. In: Liu J, Cheung Y, Yin H (eds) *Intelligent data engineering and automated learning*. Springer, Berlin, pp 195–202
13. Jones RH (2011) Bayesian information criterion for longitudinal and clustered data. *Stat Med* 30(25):3050–3056
14. Cherednichenko S (2005) *Outlier detection in clustering*
15. Provan D (2010) *Oxford handbook of clinical and laboratory investigation*. OUP Oxford
16. DeLong ER, DeLong DM, Clarke-Pearson DL (1988) Comparing the areas under two or more correlated receiver operating characteristic curves: a nonparametric approach. *Biometrics* 44(3):837–845

# Chapter 15

## Exploratory Data Analysis

Matthieu Komorowski, Dominic C. Marshall, Justin D. Saliccioli  
and Yves Crutain

### Learning Objectives

- Why is EDA important during the initial exploration of a dataset?
- What are the most essential tools of graphical and non-graphical EDA?

### 15.1 Introduction

Exploratory data analysis (EDA) is an essential step in any research analysis. The primary aim with exploratory analysis is to examine the data for distribution, outliers and anomalies to direct specific testing of your hypothesis. It also provides tools for hypothesis generation by visualizing and understanding the data usually through graphical representation [1]. EDA aims to assist the natural patterns recognition of the analyst. Finally, feature selection techniques often fall into EDA. Since the seminal work of Tukey in 1977, EDA has gained a large following as the gold standard methodology to analyze a data set [2, 3]. According to Howard Seltman (Carnegie Mellon University), “loosely speaking, any method of looking at data that does not include formal statistical modeling and inference falls under the term exploratory data analysis” [4].

EDA is a fundamental early step after data collection (see Chap. 11) and pre-processing (see Chap. 12), where the data is simply visualized, plotted, manipulated, without any assumptions, in order to help assessing the quality of the data and building models. “Most EDA techniques are graphical in nature with a few quantitative techniques. The reason for the heavy reliance on graphics is that by its very nature the main role of EDA is to explore, and graphics gives the analysts unparalleled power to do so, while being ready to gain insight into the data. There are many ways to categorize the many EDA techniques” [5].

---

**Electronic supplementary material** The online version of this chapter (doi:[10.1007/978-3-319-43742-2\\_15](https://doi.org/10.1007/978-3-319-43742-2_15)) contains supplementary material, which is available to authorized users.

The interested reader will find further information in the textbooks of Hill and Lewicki [6] or the NIST/SEMATECH e-Handbook [1]. Relevant R packages are available on the CRAN website [7].

The objectives of EDA can be summarized as follows:

1. Maximize insight into the database/understand the database structure;
2. Visualize potential relationships (direction and magnitude) between exposure and outcome variables;
3. Detect outliers and anomalies (values that are significantly different from the other observations);
4. Develop parsimonious models (a predictive or explanatory model that performs with as few exposure variables as possible) or preliminary selection of appropriate models;
5. Extract and create clinically relevant variables.

EDA methods can be cross-classified as:

- Graphical or non-graphical methods
- Univariate (only one variable, exposure or outcome) or multivariate (several exposure variables alone or with an outcome variable) methods.

## 15.2 Part 1—Theoretical Concepts

### 15.2.1 Suggested EDA Techniques

Tables 15.1 and 15.2 suggest a few EDA techniques depending on the type of data and the objective of the analysis.

**Table 15.1** Suggested EDA techniques depending on the type of data

Type of data	Suggested EDA techniques
Categorical	Descriptive statistics
Univariate continuous	Line plot, Histograms
Bivariate continuous	2D scatter plots
2D arrays	Heatmap
Multivariate: trivariate	3D scatter plot or 2D scatter plot with a 3rd variable represented in different color, shape or size
Multiple groups	Side-by-side boxplot

**Table 15.2** Most useful EDA techniques depending on the objective

Objective	Suggested EDA techniques
Getting an idea of the distribution of a variable	Histogram
Finding outliers	Histogram, scatterplots, box-and-whisker plots
Quantify the relationship between two variables (one exposure and one outcome)	2D scatter plot +/-curve fitting Covariance and correlation
Visualize the relationship between two exposure variables and one outcome variable	Heatmap
Visualization of high-dimensional data	t-SNE or PCA + 2D/3D scatterplot

*t-SNE* t-distributed stochastic neighbor embedding, *PCA* Principal component analysis

**Table 15.3** Example of tabulation table

	Group count	Frequency (%)
Green ball	15	75
Red ball	5	25
Total	20	100

## 15.2.2 Non-graphical EDA

These non-graphical methods will provide insight into the characteristics and the distribution of the variable(s) of interest.

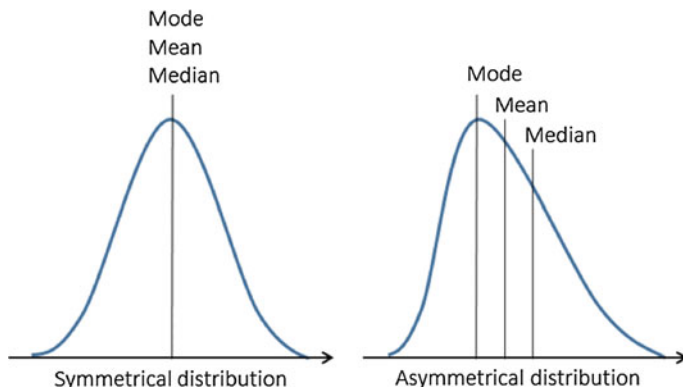
### *Univariate Non-graphical EDA*

#### *Tabulation of Categorical Data (Tabulation of the Frequency of Each Category)*

A simple univariate non-graphical EDA method for categorical variables is to build a table containing the count and the fraction (or frequency) of data of each category. An example of tabulation is shown in the case study (Table 15.3).

#### *Characteristics of Quantitative Data: Central Tendency, Spread, Shape of the Distribution (Skewness, Kurtosis)*

Sample statistics express the characteristics of a sample using a limited set of parameters. They are generally seen as estimates of the corresponding population parameters from which the sample comes from. These characteristics can express the central tendency of the data (arithmetic mean, median, mode), its spread (variance, standard deviation, interquartile range, maximum and minimum value) or some features of its distribution (skewness, kurtosis). Many of those characteristics can easily be seen qualitatively on a histogram (see below). Note that these characteristics can only be used for quantitative variables (not categorical).



**Fig. 15.1** Symmetrical versus asymmetrical (skewed) distribution, showing mode, mean and median

### Central tendency parameters

The arithmetic mean, or simply called the mean is the sum of all data divided by the number of values. The median is the middle value in a list containing all the values sorted. Because the median is affected little by extreme values and outliers, it is said to be more “robust” than the mean (Fig. 15.1).

### Variance

When calculated on the entirety of the data of a population (which rarely occurs), the variance  $\sigma^2$  is obtained by dividing the sum of squares by  $n$ , the size of the population.

The sample formula for the variance of observed data conventionally has  $n-1$  in the denominator instead of  $n$  to achieve the property of “unbiasedness”, which roughly means that when calculated for many different random samples from the same population, the average should match the corresponding population quantity (here  $\sigma^2$ ).  $s^2$  is an unbiased estimator of the population variance  $\sigma^2$ .

$$s^2 = \frac{\sum_{i=1}^n (x_i - \bar{x})^2}{(n - 1)} \quad (15.1)$$

The standard deviation is simply the square root of the variance. Therefore it has the same units as the original data, which helps make it more interpretable.

The sample standard deviation is usually represented by the symbol  $s$ . For a theoretical Gaussian distribution, mean plus or minus 1, 2 or 3 standard deviations holds 68.3, 95.4 and 99.7 % of the probability density, respectively.

### Interquartile range (IQR)

The IQR is calculated using the boundaries of data situated between the 1st and the 3rd quartiles. Please refer to the Chap. 13 “Noise versus Outliers” for further detail about the IQR.

$$IQR = Q_3 - Q_1 \quad (15.2)$$

In the same way that the median is more robust than the mean, the IQR is a more robust measure of spread than variance and standard deviation and should therefore be preferred for small or asymmetrical distributions.

#### Important rule:

- **Symmetrical distribution** (not necessarily normal) **and N > 30**: express results as mean  $\pm$  standard deviation.
- **Asymmetrical distribution or N < 30 or evidence for outliers**: use median  $\pm$  IQR, which are more robust.

### Skewness/kurtosis

Skewness is a measure of a distribution’s asymmetry. Kurtosis is a summary statistic communicating information about the tails (the smallest and largest values) of the distribution. Both quantities can be used as a means to communicate information about the distribution of the data when graphical methods cannot be used. More information about these quantities can be found in [9]).

### Summary

We provide as a reference some of the common functions in R language for generating summary statistics relating to measures of central tendency (Table 15.4).

#### *Testing the Distribution*

Several non-graphical methods exist to assess the normality of a data set (whether it was sampled from a normal distribution), like the Shapiro-Wilk test for example. Please refer to the function called “Distribution” in the GitHub repository for this book (see code appendix at the end of this Chapter).

**Table 15.4** Main R functions for basic measure of central tendencies and variability

Function	Description
summary(x)	General description of a vector
max(x)	Maximum value
mean(x)	Average or mean value
median(x)	Median value
min(x)	Smallest value
sd(x)	Standard deviation
var(x)	Variance, measure the spread or dispersion of the values
IQR(x)	Interquartile range

### Finding Outliers

Several statistical methods for outlier detection fall into EDA techniques, like Tukey’s method, Z-score, studentized residuals, etc [8]. Please refer to the Chap. 14 “Noise versus Outliers” for more detail about this topic.

### Multivariate Non-graphical EDA

#### Cross-Tabulation

Cross-tabulation represents the basic bivariate non-graphical EDA technique. It is an extension of tabulation that works for categorical data and quantitative data with only a few variables. For two variables, build a two-way table with column headings matching the levels of one variable and row headings matching the levels of the other variable, then fill in the counts of all subjects that share a pair of levels. The two variables may be both exposure, both outcome variables, or one of each.

#### Covariance and Correlation

Covariance and correlation measure the degree of the relationship between two random variables and express how much they change together (Fig. 15.2).

The covariance is computed as follows:

$$cov(x, y) = \frac{\sum_{i=1}^n (x_i - \bar{x})(y_i - \bar{y})}{n - 1} \quad (15.3)$$

where  $x$  and  $y$  are the variables,  $n$  the number of data points in the sample,  $\bar{x}$  the mean of the variable  $x$  and  $\bar{y}$  the mean of the variable  $y$ .

A positive covariance means the variables are positively related (they move together in the same direction), while a negative covariance means the variables are inversely related. A problem with covariance is that its value depends on the scale of the values of the random variables. The larger the values of  $x$  and  $y$ , the larger the

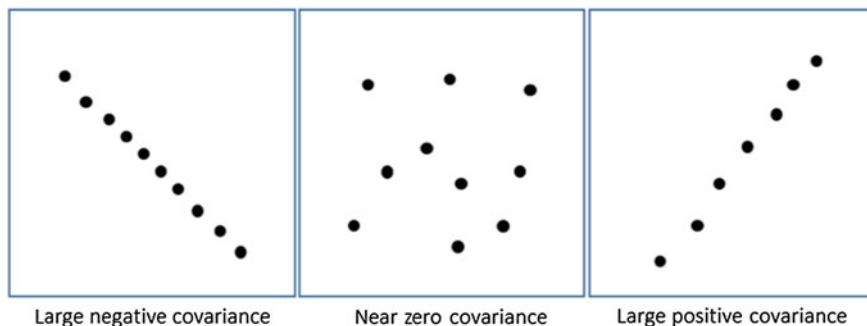


Fig. 15.2 Examples of covariance for three different data sets

covariance. It makes it impossible for example to compare covariances from data sets with different scales (e.g. pounds and inches). This issue can be fixed by dividing the covariance by the product of the standard deviation of each random variable, which gives Pearson’s correlation coefficient.

Correlation is therefore a scaled version of covariance, used to assess the linear relationship between two variables and is calculated using the formula below.

$$\text{Cor}(x, y) = \frac{\text{Cov}(x, y)}{s_x s_y} \quad (15.4)$$

where  $\text{Cov}(x, y)$  is the covariance between  $x$  and  $y$  and  $s_x, s_y$  are the sample standard deviations of  $x$  and  $y$ .

The significance of the correlation coefficient between two normally distributed variables can be evaluated using Fisher’s  $z$  transformation (see the `cor.test` function in R for more details). Other tests exist for measuring the non-parametric relationship between two variables, such as Spearman’s  $\rho$  or Kendall’s  $\tau$ .

### 15.2.3 Graphical EDA

#### *Univariate Graphical EDA*

##### *Histograms*

Histograms are among the most useful EDA techniques, and allow you to gain insight into your data, including distribution, central tendency, spread, modality and outliers.

Histograms are bar plots of counts versus subgroups of an exposure variable. Each bar represents the frequency (count) or proportion (count divided by total count) of cases for a range of values. The range of data for each bar is called a bin. Histograms give an immediate impression of the shape of the distribution (symmetrical, uni/multimodal, skewed, outliers...). The number of bins heavily influences the final aspect of the histogram; a good practice is to try different values, generally from 10 to 50. Some examples of histograms are shown below as well as in the case studies. Please refer to the function called “Density” in the GitHub repository for this book (see code appendix at the end of this Chapter) (Figs. 15.3 and 15.4).

Histograms enable to confirm that an operation on data was successful. For example, if you need to log-transform a data set, it is interesting to plot the histogram of the distribution of the data before and after the operation (Fig. 15.5).

Histograms are interesting for finding outliers. For example, pulse oximetry can be expressed in fractions (range between 0 and 1) or percentage, in medical records. Figure 15.6 is an example of a histogram showing the distribution of pulse oximetry, clearly showing the presence of outliers expressed in a fraction rather than as a percentage.



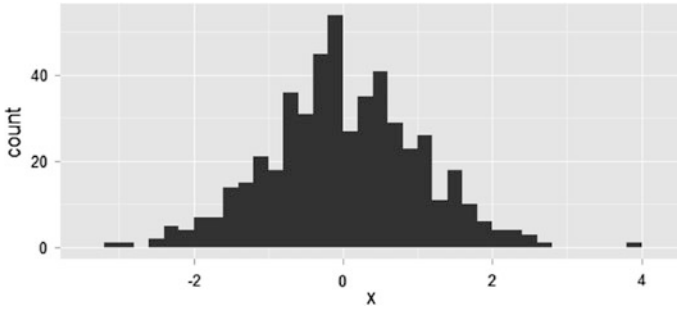


Fig. 15.3 Example of histogram

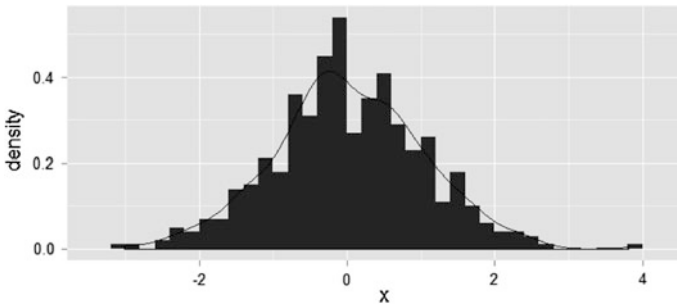


Fig. 15.4 Example of histogram with density estimate

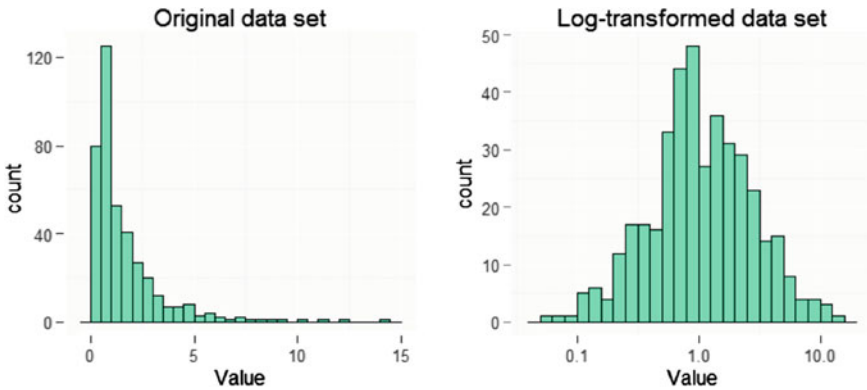
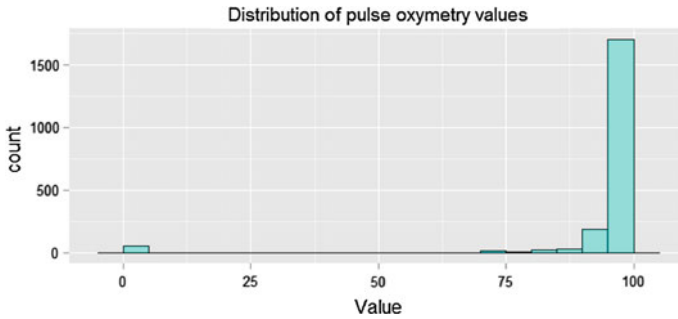


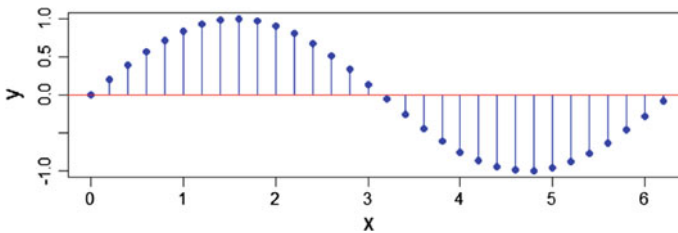
Fig. 15.5 Example of the effect of a log transformation on the distribution of the dataset

*Stem Plots*

Stem and leaf plots (also called stem plots) are a simple substitution for histograms. They show all data values and the shape of the distribution. For an example, Please refer to the function called “Stem Plot” in the GitHub repository for this book (see code appendix at the end of this Chapter) (Fig. 15.7).



**Fig. 15.6** Distribution of pulse oximetry



**Fig. 15.7** Example of stem plot

### *Boxplots*

Boxplots are interesting for representing information about the central tendency, symmetry, skew and outliers, but they can hide some aspects of the data such as multimodality. Boxplots are an excellent EDA technique because they rely on robust statistics like median and IQR.

Figure 15.8 shows an annotated boxplot which explains how it is constructed. The central rectangle is limited by  $Q1$  and  $Q3$ , with the middle line representing the median of the data. The whiskers are drawn, in each direction, to the most extreme point that is less than 1.5 IQR beyond the corresponding hinge. Values beyond 1.5 IQR are considered outliers.

The “outliers” identified by a boxplot, which could be called “boxplot outliers” are defined as any points more than 1.5 IQRs above  $Q3$  or more than 1.5 IQRs below  $Q1$ . This does not by itself indicate a problem with those data points. Boxplots are an exploratory technique, and you should consider designation as a boxplot outlier as just a suggestion that the points might be mistakes or otherwise unusual. Also, points not designated as boxplot outliers may also be mistakes. It is also important to realize that the number of boxplot outliers depends strongly on the size of the sample. In fact, for data that is perfectly normally distributed, we expect 0.70 % (about 1 in 140 cases) to be “boxplot outliers”, with approximately half in either direction.

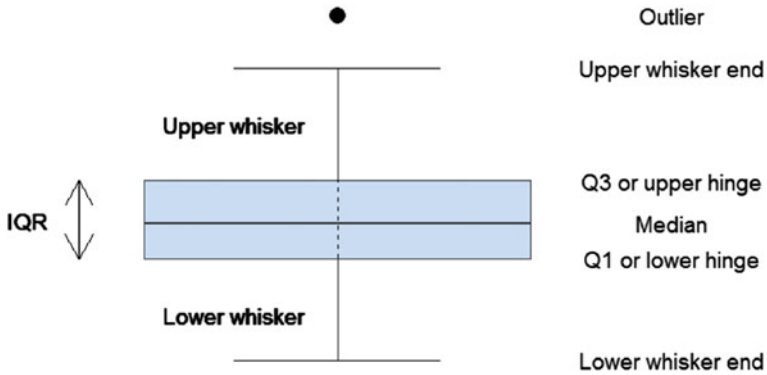


Fig. 15.8 Example of boxplot with annotations

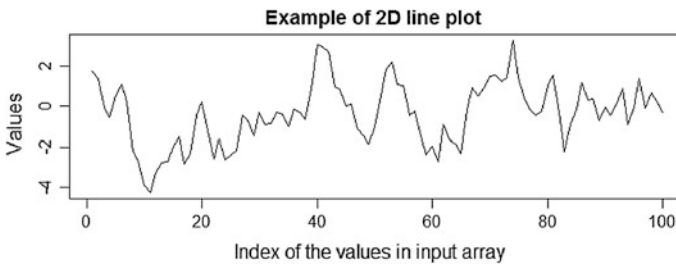


Fig. 15.9 Example of 2D line plot

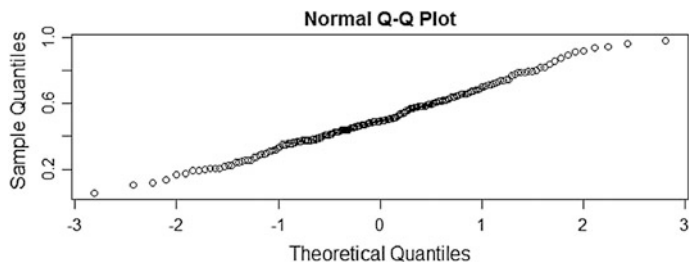
### 2D Line Plot

2D line plots represent graphically the values of an array on the y-axis, at regular intervals on the x-axis (Fig. 15.9).

### Probability Plots (*Quantile-Normal Plot/QN Plot, Quantile-Quantile Plot/QQ Plot*)

Probability plots are a graphical test for assessing if some data follows a particular distribution. They are most often used for testing the normality of a data set, as many statistical tests have the assumption that the exposure variables are approximately normally distributed. These plots are also used to examine residuals in models that rely on the assumption of normality of the residuals (ANOVA or regression analysis for example).

The interpretation of a QN plot is visual (Fig. 15.10): either the points fall randomly around the line (data set normally distributed) or they follow a curved pattern instead of following the line (non-normality). QN plots are also useful to identify skewness, kurtosis, fat tails, outliers, bimodality etc.



**Fig. 15.10** Example of QQ plot

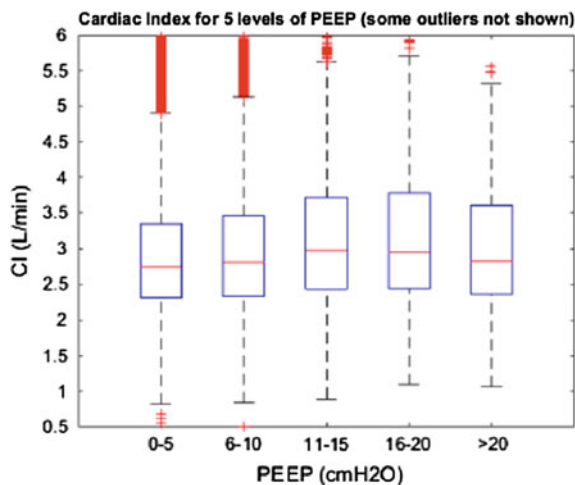
Besides the probability plots, there are many quantitative statistical tests (not graphical) for testing for normality, such as Pearson  $\chi^2$ , Shapiro-Wilk, and Kolmogorov-Smirnov.

Deviation of the observed distribution from normal makes many powerful statistical tools useless. Note that some data sets can be transformed to a more normal distribution, in particular with log-transformation and square-root transformations. If a data set is severely skewed, another option is to discretize its values into a finite set.

### ***Multivariate Graphical EDA***

#### *Side-by-Side Boxplots*

Representing several boxplots side by side allows easy comparison of the characteristics of several groups of data (example Fig. 15.11). An example of such boxplot is shown in the case study.



**Fig. 15.11** Side-by-side boxplot showing the cardiac index for five levels of Positive end-expiratory pressure (PEEP)

### Scatterplots

Scatterplots are built using two continuous, ordinal or discrete quantitative variables (Fig. 15.12). Each data point's coordinate corresponds to a variable. They can be complexified to up to five dimensions using other variables by differentiating the data points' size, shape or color.

Scatterplots can also be used to represent high-dimensional data in 2 or 3D (Fig. 15.13), using T-distributed stochastic neighbor embedding (t-SNE) or principal component analysis (PCA). t-SNE and PCA are dimension reduction features used to reduce complex data set in two (t-SNE) or more (PCA) dimensions.

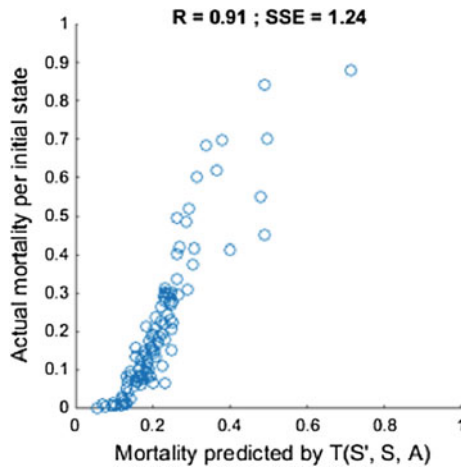


Fig. 15.12 Scatterplot showing an example of actual mortality per rate of predicted mortality

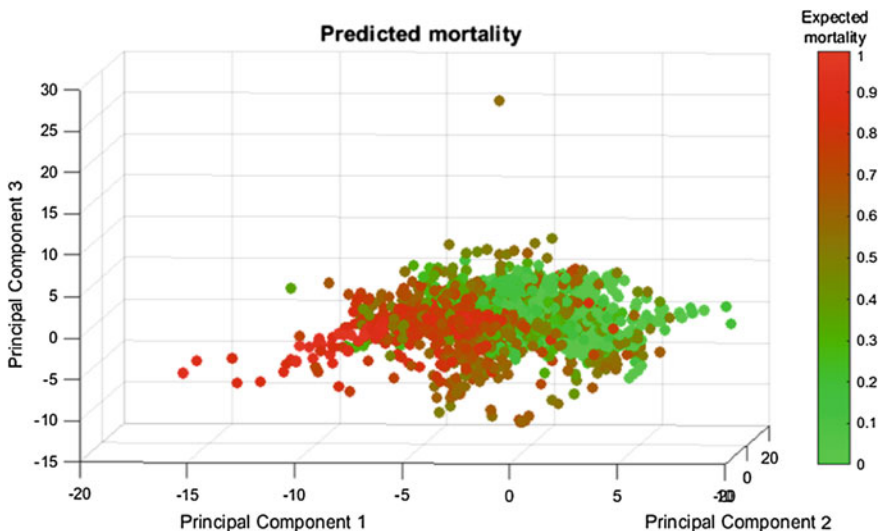


Fig. 15.13 3D representation of the first three dimension of a PCA

For binary variables (e.g. 28-day mortality vs. SOFA score), 2D scatterplots are not very helpful (Fig. 15.14, left). By dividing the data set in groups (in our example: one group per SOFA point), and plotting the average value of the outcome in each group, scatterplots become a very powerful tool, capable for example to identify a relationship between a variable and an outcome (Fig. 15.14, right).

*Curve Fitting*

Curve fitting is one way to quantify the relationship between two variables or the change in values over time (Fig. 15.15). The most common method for curve fitting relies on minimizing the sum of squared errors (SSE) between the data and the

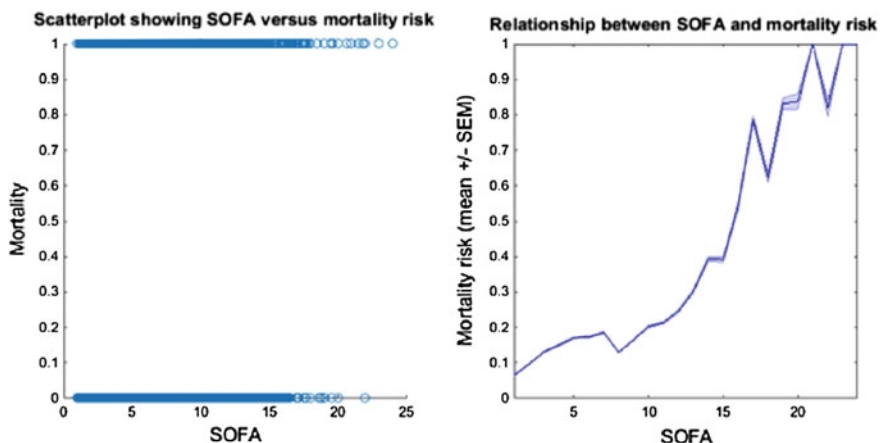


Fig. 15.14 Graphs of SOFA versus mortality risk

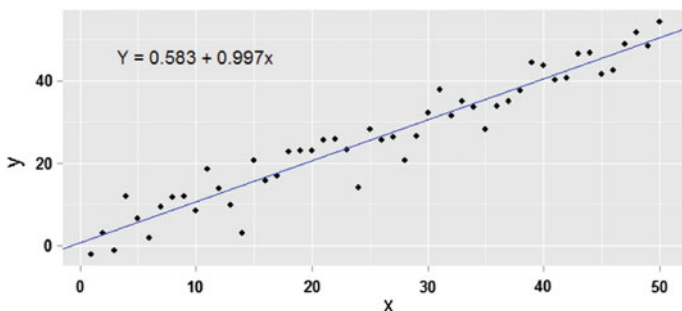


Fig. 15.15 Example of linear regression

fitted function. Please refer to the “Linear Fit” function to create linear regression slopes in R.

### More Complicated Relationships

Many real life phenomena are not adequately explained by a straight-line relationship. An always increasing set of methods and algorithms exist to deal with that issue. Among the most common:

- Adding transformed explanatory variables, for example, adding  $x^2$  or  $x^3$  to the model.
- Using other algorithms to handle more complex relationships between variables (e.g., generalized additive models, spline regression, support vector machines, etc.).

### Heat Maps and 3D Surface Plots

Heat maps are simply a 2D grid built from a 2D array, whose color depends on the value of each cell. The data set must correspond to a 2D array whose cells contain the values of the outcome variable. This technique is useful when you want to represent the change of an outcome variable (e.g. length of stay) as a function of two other variables (e.g. age and SOFA score).

The color mapping can be customized (e.g. rainbow or grayscale). Interestingly, the Matlab function *imagesc* scales the data to the full colormap range. Their 3D equivalent is mesh plots or surface plots (Fig. 15.16).

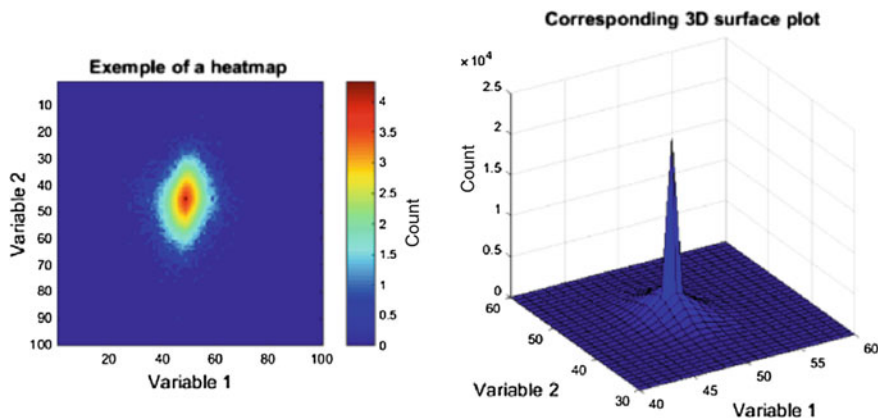


Fig. 15.16 Heat map (*left*) and surface plot (*right*)

## 15.3 Part 2—Case Study

This case study refers to the research that evaluated the effect of the placement of indwelling arterial catheters (IACs) in hemodynamically stable patients with respiratory failure in intensive care, from the MIMIC-II database.

For this case study, several aspects of EDA were used:

- The categorical data was first tabulated.
- Summary statistics were then generated to describe the variables of interest.
- Graphical EDA was used to generate histograms to visualize the data of interest.

### 15.3.1 Non-graphical EDA

#### *Tabulation*

To analyze, visualize and test for association or independence of categorical variables, they must first be tabulated. When generating tables, any missing data will be counted in a separate “NA” (“Not Available”) category. Please refer to the Chap. 13 “Missing Data” for approaches in managing this problem. There are several methods for creating frequency or contingency tables in R, such as for example, tabulating outcome variables for mortality, as demonstrated in the case study. Refer to the “Tabulate” function found in the GitHub repository for this book (see code appendix at the end of this Chapter) for details on how to compute frequencies of outcomes for different variables.

#### *Statistical Tests*

Multiple statistical tests are available in R and we refer the reader to the Chap. 16 “Data Analysis” for additional information on use of relevant tests in R. For examples of a simple Chi-square...” as “For examples of a simple Chi-squared test, please refer to the “Chi-squared” function found in the GitHub repository for this book (see code appendix at the end of this Chapter). In our example, the hypothesis of independence between expiration in ICU and IAC is accepted ( $p > 0.05$ ). On the contrary, the dependence link between day-28 mortality and IAC is rejected.

#### *Summary statistics*

Summary statistics as described above include, frequency, mean, median, mode, range, interquartile range, maximum and minimum values. An extract of summary statistics of patient demographics, vital signs, laboratory results and comorbidities, is shown in Table 6. Please refer to the function called “EDA Summary” in the



**Table 15.5** Comparison between the two study cohorts (subsample of variables only)

Variables	Entire Cohort (N = 1776)		
	Non-IAC	IAC	<i>p</i> -value
Size	984 (55.4 %)	792 (44.6 %)	NA
Age (year)	51 (35–72)	56 (40–73)	0.009
Gender (female)	344 (43.5 %)	406 (41.3 %)	0.4
Weight (kg)	76 (65–90)	78 (67–90)	0.08
SOFA score	5 (4–6)	6 (5–8)	<0.0001
<i>Co-morbidities</i>			
CHF	97 (12.5 %)	116 (11.8 %)	0.7
...	...	...	...
<i>Lab tests</i>			
WBC	10.6 (7.8–14.3)	11.8 (8.5–15.9)	<0.0001
Hemoglobin (g/dL)	13 (11.3–14.4)	12.6 (11–14.1)	0.003
...	...	...	...

GitHub repository for this book (see code appendix at the end of this Chapter) (Table 15.5).

When separate cohorts are generated based on a common variable, in this case the presence of an indwelling arterial catheter, summary statistics are presented for each cohort.

It is important to identify any differences in subject baseline characteristics. The benefits of this are two-fold: first it is useful to identify potentially confounding variables that contribute to an outcome in addition to the predictor (exposure) variable. For example, if mortality is the outcome variable then differences in severity of illness between cohorts may wholly or partially account for any variance in mortality. Identifying these variables is important as it is possible to attempt to control for these using adjustment methods such as multivariable logistic regression. Secondly, it may allow the identification of variables that are associated with the predictor variable enriching our understanding of the phenomenon we are observing.

The analytical extension of identifying any differences using medians, means and data visualization is to test for statistically significant differences in any given subject characteristic using for example Wilcoxon-Rank sum test. Refer to Chap. 16 for further details in hypothesis testing.

### 15.3.2 Graphical EDA

Graphical representation of the dataset of interest is the principle feature of exploratory analysis.

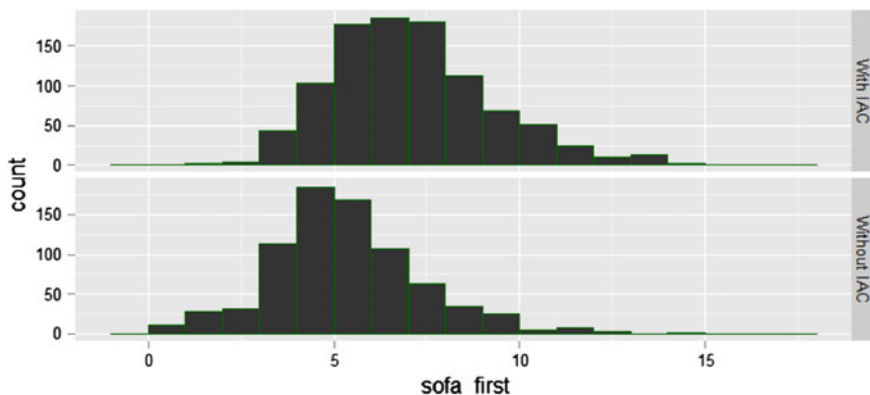


Fig. 15.17 histograms of SOFA scores by intra-arterial catheter status

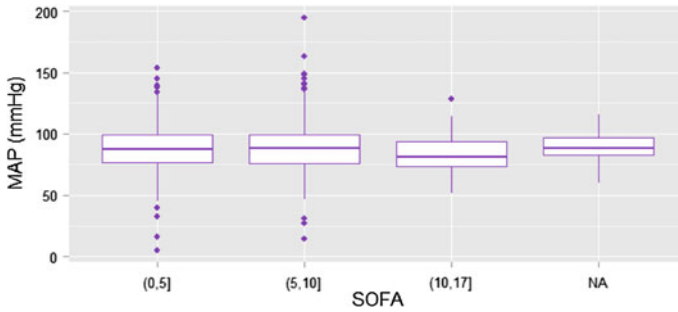
### Histograms

Histograms are considered the backbone of EDA for continuous data. They can be used to help the researcher understand continuous variables and provide key information such as their distribution. Outlined in *noise and outliers*, the histogram allows the researcher to visualize where the bulk of the data points are placed between the maximum and minimum values. Histograms can also allow a visual comparison of a variable between cohorts. For example, to compare severity of illness between patient cohorts, histograms of SOFA score can be plotted side by side (Fig. 15.17). An example of this is given in the code for this chapter using the “side-by-side histogram” function (see code appendix at the end of this Chapter).

### Boxplot and ANOVA

Outside of the scope of this case study, the user may be interested in analysis of variance. When performing EDA and effective way to visualize this is through the use of boxplot. For example, to explore differences in blood pressure based on severity of illness subjects could be categorized by severity of illness with blood pressure values at baseline plotted (Fig. 15.18). Please refer to the function called “Box Plot” in the GitHub repository for this book (see code appendix at the end of this Chapter).

The box plot shows a few outliers which may be interesting to explore individually, and that people with a high SOFA score (>10) tend to have a lower blood pressure than people with a lower SOFA score.



**Fig. 15.18** Side-by-side boxplot of MAP for different levels of severity at admission

## 15.4 Conclusion

In summary, EDA is an essential step in many types of research but is of particular use when analyzing electronic health care records. The tools described in this chapter should allow the researcher to better understand the features of a dataset and also to generate novel hypotheses.

### Take Home Messages

1. Always start by exploring a dataset with an open mind for discovery.
2. EDA allows to better apprehend the features and possible issues of a dataset.
3. EDA is a key step in generating research hypothesis.

**Open Access** This chapter is distributed under the terms of the Creative Commons Attribution-NonCommercial 4.0 International License (<http://creativecommons.org/licenses/by-nc/4.0/>), which permits any noncommercial use, duplication, adaptation, distribution and reproduction in any medium or format, as long as you give appropriate credit to the original author(s) and the source, a link is provided to the Creative Commons license and any changes made are indicated.

The images or other third party material in this chapter are included in the work's Creative Commons license, unless indicated otherwise in the credit line; if such material is not included in the work's Creative Commons license and the respective action is not permitted by statutory regulation, users will need to obtain permission from the license holder to duplicate, adapt or reproduce the material.

## Code Appendix

The code used in this chapter is available in the GitHub repository for this book: <https://github.com/MIT-LCP/critical-data-book>. Further information on the code is available from this website.

## References

1. Natrella M (2010) NIST/SEMATECH e-Handbook of Statistical Methods. NIST/SEMATECH
2. Mosteller F, Tukey JW (1977) Data analysis and regression. Addison-Wesley Pub. Co., Boston
3. Tukey J (1977) Exploratory data analysis. Pearson, London
4. Seltman HJ (2012) Experimental design and analysis. Online <http://www.stat.cmu.edu/~hseltman/309/Book/Book.pdf>
5. Kaski, Samuel (1997) "Data exploration using self-organizing maps." *Acta polytechnica scandinavica: Mathematics, computing and management in engineering series no. 82. 1997.*
6. Hill T, Lewicki P (2006) Statistics: methods and applications: a comprehensive reference for science, industry, and data mining. StatSoft, Inc., Tulsa
7. CRAN (2016) The Comprehensive R archive network—packages. Contributed Packages, 10 Jan 2016 [Online]. Available: <https://cran.r-project.org/web/packages/>. Accessed: 10 Jan 2016
8. Grubbs F (1969) Procedures for detecting outlying observations in samples. *Technometrics* 11(1)
9. Joanes DN, Gill CA (1998) Comparing measures of sample skewness and kurtosis. *The Statistician* 47:183–189.

# Chapter 16

## Data Analysis

Jesse D. Raffa, Marzyeh Ghassemi, Tristan Naumann,  
Mengling Feng and Douglas Hsu

### Learning Objectives

- Understand how the study objective and data types determine the type of data analysis.
- Understand the basics of the three most common analysis techniques used in the studies involving health data.
- Execute a case study to fulfil the study objective, and interpret the results.

## 16.1 Introduction to Data Analysis

### 16.1.1 Introduction

This chapter presents an overview of data analysis for health data. We give a brief introduction to some of the most common methods for data analysis of health care data, focusing on choosing appropriate methodology for different types of study objectives, and on presentation and the interpretation of data analysis generated from health data. We will provide an overview of three very powerful analysis methods: linear regression, logistic regression and Cox proportional hazards models, which provide the foundation for most data analysis conducted in clinical studies.

#### *Chapter Goals*

By the time you complete this chapter you should be able to:

1. Understand how different study objectives will influence the type of data analysis (Sect. 16.1)
2. Be able to carry out three different types of data analysis that are common for health data (Sects. 16.2–16.4).
3. Present and interpret the results of these analyses types (Sects. 16.2–16.4)

4. Understand the limitations and assumptions underlying the different types of analyses (Sects. 16.2–16.4).
5. Replicate an analysis from a case study using some of the methods learned in the chapter (Sect. 16.5)

### ***Outline***

This chapter is composed of five sections. First, in this section we will cover identifying data types and study objectives. These topics will enable us to pick an appropriate analysis method among linear (Sect. 16.2) or logistic (Sect. 16.3) regression, and survival analysis (Sect. 16.4), which comprise the next three sections. Following that, we will use what we learned on a case study using real data from Medical Information Mart for Intensive Care II (MIMIC-II), briefly discuss model building and finally, summarize what we have learned (Sect. 16.5)

## ***16.1.2 Identifying Data Types and Study Objectives***

In this section we will examine how different study objectives and data types affect the approaches one takes for data analysis. Understanding the data structure and study objective is likely the most important aspect to choosing an appropriate analysis technique.

### ***Study Objectives***

Identifying the study objective is an extremely important aspect of planning data analysis for health data. A vague or poorly described objective often leads to a poorly executed analysis. The study objective should clearly identify the study population, the outcome of interest, the covariate(s) of interest, the relevant time points of the study, and what you would like to do with these items. Investing time to make the objective very specific and clear often will save time in the long run.

An example of a clearly stated study objective would be:

To estimate the reduction in 28 day mortality associated with vasopressor use during the first three days from admission to the MICU in MIMIC II.

An example of a vague and difficult to execute study objective may be:

To predict mortality in ICU patients.

While both may be trying to accomplish the same goal, the first gives a much clearer path for the data scientist to perform the necessary analysis, as it identifies the study population (those admitted to the MICU in MIMIC II), outcome (28 day mortality), covariate of interest (vasopressor use in the first three days of the MICU admission), relevant time points (28 days for the outcome, within the first three days for the covariate). The objective does not need to be overly complicated, and

it's often convenient to specify primary and secondary objectives, rather than an overly complex single objective.

### ***Data Types***

After specifying a clear study objective, the next step is to determine the types of data one is dealing with. The first distinction is between outcomes and covariates. Outcomes are what the study aims to investigate, improve or affect. In the above example of a clearly stated objective, our outcome is 28 day mortality. Outcomes are also sometimes referred to as response or dependent variables. Covariates are the variables you would like to study for their effect on the outcome, or believe may have some nuisance effect on the outcome you would like to control for. Covariates also go by several different names, including: features, predictors, independent variables and explanatory variables. In our example objective, the primary covariate of interest is vasopressor use, but other covariates may also be important in affecting 28 day mortality, including age, gender, and so on.

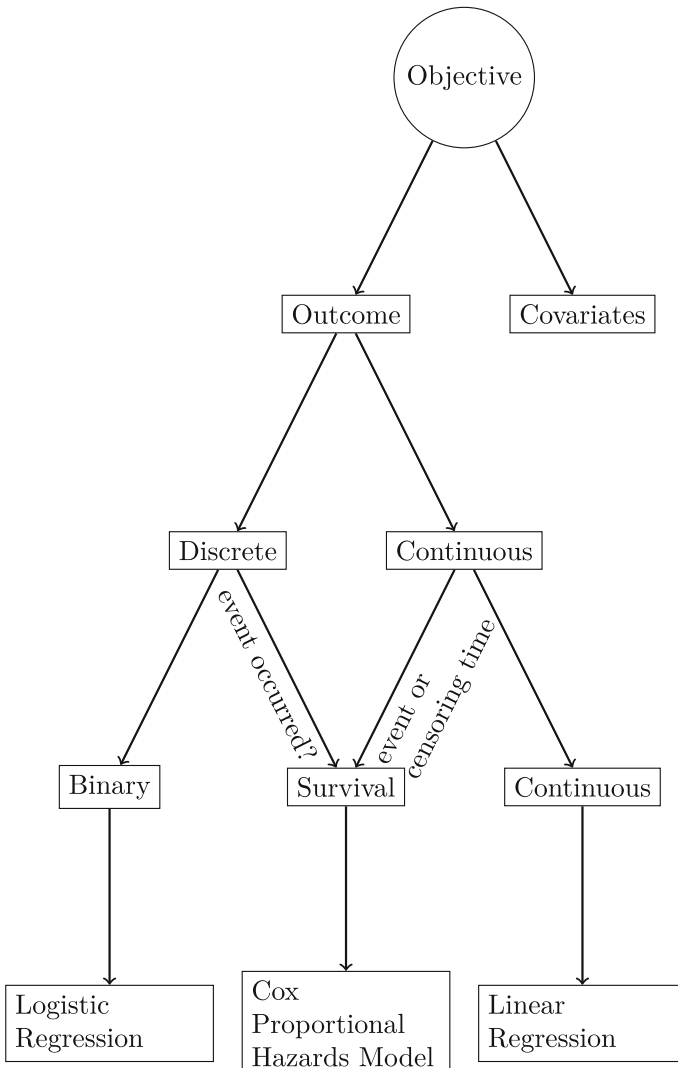
Once you have identified the study outcomes and covariates, determining the data types of the outcomes will often be critical in choosing an appropriate analysis technique. Data types can generally be identified as either continuous or discrete. Continuous variables are those which can plausibly take on any numeric (real number) value, although this requirement is often not explicitly met. This contrasts with discrete data, which usually takes on only a few values. For instance, gender can take on two values: male or female. This is a *binary* variable as it takes on two values. More discussion on data types can be found in Chap. 11.

There is a special type of data which can be considered simultaneously as continuous and discrete types, as it has two components. This frequently occurs in time to event data for outcomes like mortality, where both the occurrence of death and the length of survival are of interest. In this case, the discrete component is if the event (e.g., death) occurred during the observation period, and the continuous component is the time at which death occurred. The time at which the death occurred is not always available: in this case the time of the last observation is used, and the data is partially *censored*. We discuss censoring in more detail later in Sect. 16.4.

Figure 16.1 outlines the typical process by which you can identify outcomes from covariates, and determine which type of data type your outcome is. For each of the types of outcomes we highlighted—continuous, binary and survival, there are a set of analysis methods that are most common for use in health data—linear regression, logistic regression and Cox proportional hazards models, respectively.

### ***Other Important Considerations***

The discussion thus far has given a basic outline of how to choose an analysis method for a given study objective. Some caution is merited as this discussion has been rather brief and while it covers some of the most frequently used methods for analyzing health data, it is certainly not exhaustive. There are many situations where this framework and subsequent discussion will break down and other methods will be necessary. In particular, we highlight the following situations:



**Fig. 16.1** Flow diagram of simplified process for choosing an analysis method based on the study objective and outcome data types

1. When the data is not patient level data, such as aggregated data (totals) instead of individual level data.
2. When patients contribute more than one observation (i.e., outcome) to the dataset.

In these cases, other techniques should be used.



### 16.1.3 Case Study Data

We will be using a case study [1] to explore data analysis approaches in health data. The case study data originates from a study examining the effect of indwelling arterial catheters (IAC) on 28 day mortality in the intensive care unit (ICU) in patients who were mechanically ventilated during the first day of ICU admission. The data comes from MIMIC II v2.6. At this point you are ready to do data analysis (the data extraction and cleaning has already been completed) and we will be using a comma separated (.csv) file generated after this process, which you can load directly off of PhysioNet [2, 3]:

```
url <- "http://physionet.org/physiobank/database/mimic2-iaccd/full_cohort_data.csv";
dat <- read.csv(url)
# Or download the csv file from:
# http://physionet.org/physiobank/database/mimic2-iaccd/full_cohort_data.csv
# Type: dat <- read.csv(file.choose())
# And navigate to the file you downloaded (likely in your download directory)
```

The header of this file with the variable names can be accessed using the `names` function in R.

```
names(dat)
```

```
## [1] "aline_flg"          "icu_los_day"        "hospital_los_day"
## [4] "age"               "gender_num"        "weight_first"
## [7] "bmi"              "sapsi_first"       "sofa_first"
## [10] "service_unit"     "service_num"       "day_icu_intime"
## [13] "day_icu_intime_num" "hour_icu_intime"   "hosp_exp_flg"
## [16] "icu_exp_flg"      "day_28_flg"        "mort_day_censored"
## [19] "censor_flg"      "sepsis_flg"        "chf_flg"
## [22] "afib_flg"        "renal_flg"         "liver_flg"
## [25] "copd_flg"        "cad_flg"           "stroke_flg"
## [28] "mal_flg"         "resp_flg"          "map_1st"
## [31] "hr_1st"          "temp_1st"          "spo2_1st"
## [34] "abg_count"       "wbc_first"         "hgb_first"
## [37] "platelet_first"  "sodium_first"      "potassium_first"
## [40] "tco2_first"     "chloride_first"    "bun_first"
## [43] "creatinine_first" "po2_first"         "pco2_first"
## [46] "iv_day_1"
```

There are 46 variables listed. The primary focus of the study was on the effect that IAC placement (`aline_flg`) has on 28 day mortality (`day_28_flg`). After we have covered the basics, we will identify a research objective and an appropriate analysis technique, and execute an abbreviated analysis to illustrate how to use these techniques to address real scientific questions. Before we do this, we need to cover the basic techniques, and we will introduce three powerful data analysis methods frequently used in the analysis of health data. We will use examples from

the case study dataset to introduce these concepts, and will return to the the question of the effect of IAC has on mortality towards the end of thischapter.

## 16.2 Linear Regression

### 16.2.1 Section Goals

In this section, the reader will learn the fundamentals of linear regression, and how to present and interpret such an analysis.

### 16.2.2 Introduction

Linear regression provides the foundation for many types of analyses we perform on health data. In the simplest scenario, we try to relate one continuous outcome,  $y$ , to a single continuous covariate,  $x$ , by trying to find values for  $\beta_0$  and  $\beta_1$  so that the following equation:

$$y = \beta_0 + \beta_1 \times x$$

fits the data ‘optimally’.<sup>1</sup> We call these optimal values:  $\hat{\beta}_0$  and  $\hat{\beta}_1$  to distinguish them from the true values of  $\beta_0$  and  $\beta_1$  which are often unknowable. In Fig. 16.2, we see a scatter plot of TCO2 ( $y$ : outcome) levels versus PCO2 ( $x$ : covariate) levels. We can clearly see that as PCO2 levels increase, the TCO2 levels also increase. This would suggest that we may be able to fit a linear regression model which predicts TCO2 from PCO2.

It is always a good idea to visualize the data when you can, which allows one to assess if the subsequent analysis corresponds to what you could see with your eyes. In this case, a scatter plot can be produced using the `plot` function:

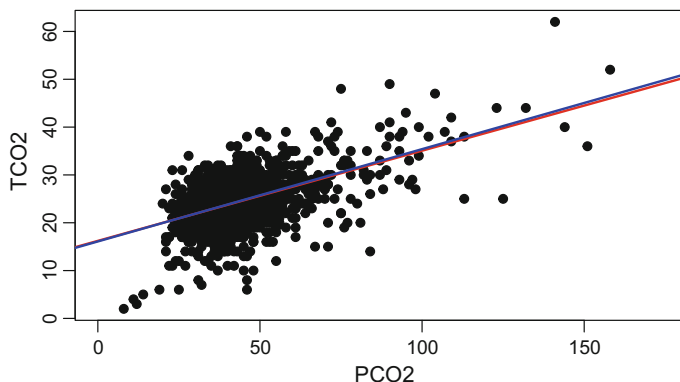
```
plot(dat$pco2_first, dat$tc02_first, xlab="PCO2", ylab="TCO2", pch=19, xlim=c(0,175))
```

which produces the scattered points in Fig. 16.2.

Finding the best fit line for the scatter plot in Fig. 16.2 in R is relatively straightforward:

---

<sup>1</sup>Exactly what optimally means is beyond the scope of this chapter, but for those who are interested, we are trying to find values of  $\beta_0$  and  $\beta_1$  which minimize the squared distance between the fitted line and the observed data point, summed over all data points. This quantity is known as sum of squares error, or when divided by the number of observations is known as the mean squared error.



**Fig. 16.2** Scatterplot of PCO2 (x-axis) and TCO2 (y-axis) along with linear regression estimates from the quadratic model (`co2.quad.lm`) and linear only model (`co2.lm`)

```
co2.lm <- lm(tco2_first ~ pco2_first, data=dat)
```

Dissecting this command from left to right. The `co2.lm <-` part assigns the right part of the command to a new variable or object called `co2.lm` which contains information relevant to our linear regression model. The right side of this command runs the `lm` function in R. `lm` is a powerful function in R that fits linear models. As with any command in R, you can find additional help information by running `?lm` from the R command prompt. The basic `lm` command has two parts. The first is the formula which has the general syntax `outcome ~ covariates`. Here, our outcome variable is called `tco2_first` and we are just fitting one covariate, `pco2_first`, so our formula is `tco2_first ~ pco2_first`. The second argument is separated by a comma and is specifying the data frame to use. In our case, the data frame is called `dat`, so we pass `data = dat`, noting that both `tco2_first` and `pco2_first` are columns in the dataframe `dat`. The overall procedure of specifying a model formula (`tco2_first ~ pco2_first`), a data frame (`data = dat`) and passing it an appropriate R function (`lm`) will be used throughout this chapter, and is the foundation for many types of statistical modeling in R.

We would like to see some information about the model we just fit, and often a good way of doing this is to run the `summary` command on the object we created:

```
summary(co2.lm)

##
## Call:
## lm(formula = tco2_first ~ pco2_first, data = dat)
##
## Residuals:
##      Min       1Q   Median       3Q      Max
## -18.8852  -2.5080   0.1891   2.8077  19.2005
##
## Coefficients:
##              Estimate Std. Error t value Pr(>|t|)
## (Intercept) 16.210859   0.359676   45.07  <2e-16 ***
## pco2_first   0.188572   0.007886   23.91  <2e-16 ***
## ---
## Signif. codes:  0 '***' 0.001 '**' 0.01 '*' 0.05 '.' 0.1 ' ' 1
##
## Residual standard error: 4.395 on 1588 degrees of freedom
## (186 observations deleted due to missingness)
## Multiple R-squared:  0.2647, Adjusted R-squared:  0.2643
## F-statistic: 571.8 on 1 and 1588 DF,  p-value: < 2.2e-16
```

This outputs information about the `lm` object we created in the previous step. The first part recalls the model we fit, which is useful when we have fit many models, and are trying to compare them. The second part lists some summary information about what are called residuals—an important topic for validating modeling assumptions covered in [8]. Next lists the coefficient estimates—these are the  $\hat{\beta}_0$ , (Intercept), and  $\hat{\beta}_1$ , `pco2_first`, parameters in the best fit line we are trying to estimate. This output is telling us that the best fit equation for the data is:

$$\text{tco2\_first} = 16.21 + 0.189 \times \text{pco2\_first}.$$

These two quantities have important interpretations. The estimated intercept ( $\hat{\beta}_0$ ) tells us what TCO2 level we would predict for an individual with a PCO2 level of 0. This is the mathematical interpretation, and often this quantity has limited practical use. The estimated slope ( $\hat{\beta}_1$ ) on the other hand can be interpreted as how quickly the predicted value of TCO2 goes up for every unit increase in PCO2. In this case, we estimate that TCO2 goes up about 0.189 mmol/L for every 1 mm Hg increase in PCO2. Each coefficient estimate has a corresponding Std. Error (standard error). This is a measure of how certain we are about the estimate. If the standard error is large relative to the coefficient then we are less certain about our estimate. Many things can affect the standard error, including the study sample size. The next column in this table is the `t value`, which is simply the coefficient estimate divided by the standard error. This is followed by `Pr(>|t|)` which is also known as the *p*-value. The last two quantities are relevant to an area of statistics called hypothesis testing which we will cover briefly now.

### ***Hypothesis Testing***

Hypothesis testing in statistics is fundamentally about evaluating two competing hypotheses. One hypothesis, called the *null hypothesis* is setup as a straw man (a sham argument set up to be defeated), and is the hypothesis you would like to provide evidence *against*. In the analysis methods we will discuss in this chapter, this is almost always  $\beta_k = 0$ , and it is often written as  $H_0 : \beta_k = 0$ . The alternative (second) hypothesis is commonly assumed to be  $\beta_k \neq 0$ , and will often be written as  $H_A : \beta_k \neq 0$ . A statistical significance level,  $\alpha$ , should be established before any analysis is performed. This value is known as the Type I error, and is the probability of rejecting the null hypothesis when the null hypothesis is true, i.e. of incorrectly concluding that the null hypothesis is false. In our case, it is the probability that we falsely conclude that the coefficient is non-zero, when the coefficient is actually zero. It is common to set the Type I error at 0.05.

After specifying the null and alternative hypotheses, along with the significance level, hypotheses can be tested by computing a  $p$ -value. The actual computation of  $p$ -values is beyond the scope of this chapter, but we will cover the interpretation and provide some intuition.  $P$ -values are the probability of observing data as extreme or more extreme than what was seen, assuming the null hypothesis is *true*. The null hypothesis is  $\beta_k = 0$ , so when would this be unlikely? It is probably unlikely when we estimate  $\beta_k$  to be rather large. However, how large is large enough? This would likely depend on how certain we are about the estimate of  $\beta_k$ . If we were very certain,  $\hat{\beta}_k$  likely would not have to be very large, but if we are less certain, then we might not think it to be unlikely for even very large values of  $\hat{\beta}_k$ . A  $p$ -value balances both of these aspects, and computes a single number. We reject the null hypothesis when the  $p$ -value is smaller than the significance level,  $\alpha$ .

Returning to our fit model, we see that the  $p$ -value for both coefficients are tiny ( $<2e-16$ ), and we would reject both null hypotheses, concluding that neither coefficient is likely zero. What do these two hypotheses mean at a practical level? The intercept being zero,  $\beta_0 = 0$  would imply the best fit line goes through the origin [ the (x, y) point (0, 0)], and we would reject this hypothesis. The slope being zero would mean that the best fit line would be a flat horizontal line, and did not increase as PCO2 increases. Clearly there is a relationship between TCO2 and PCO2, so we would also reject this hypothesis. In summary, we would conclude that we need both an intercept and a slope in the model. A next obvious question would be, could the relationship be more complicated than a straight line? We will examine this next.

### ***16.2.3 Model Selection***

Model selection are techniques related to selecting the best model from a list (perhaps rather large list) of candidate models. We will cover some basics here, as

more complicated techniques will be covered in a later chapter. In the simplest case, we have two models, and we want to know which one we should use.

We will begin by examining if the relationship between TCO2 and PCO2 is more complicated than the model we fit in the previous section. If you recall, we fit a model where we considered a linear `pco2_first` term:  $\text{tco2\_first} = \beta_0 + \beta_1 \times \text{pco2\_first}$ . One may wonder if including a quadratic term would fit the data better, i.e. whether:

$$\text{tco2\_first} = \beta_0 + \beta_1 \times \text{pco2\_first} + \beta_2 \times \text{pco2\_first}^2,$$

is a better model. One way to evaluate this is by testing the null hypothesis:  $\beta_2 = 0$ . We do this by fitting the above model, and looking at the output. Adding a quadratic term (or any other function) is quite easy using the `lm` function. It is best practice to enclose any of these functions in the `I()` function to make sure they get evaluated as you intended. The `I()` forces the formula to evaluate what is passed to it as is, as the `^` operator has a different use in formulas in R (see `?formula` for further details). Fitting this model, and running the `summary` function for the model:

```
co2.quad.lm <- lm(tco2_first ~ pco2_first + I(pco2_first^2),data=dat)
summary(co2.quad.lm)$coef

##              Estimate Std. Error t value Pr(>|t|)
## (Intercept)  16.0916260327 0.7713394026 20.8619266 1.309513e-85
## pco2_first    0.1930281243 0.0266927962  7.2314689 7.401248e-13
## I(pco2_first^2) -0.0000356873 0.0002042135 -0.1747548 8.612946e-01
```

You will note that we have abbreviated the output from the `summary` function by appending `$coef` to the `summary` function: this tells R we would like information about the coefficients only. Looking first at the estimates, we see the best fit line is estimated as:

$$\text{tco2\_first} = 160.09 + 0.19 \times \text{pco2\_first} + 0.00004 \times \text{pco2\_first}^2.$$

We can add both best fit lines to Fig. 16.2 using the `abline` function:

```
abline(co2.lm,col='red')
abline(co2.quad.lm,col='blue')
```

and one can see that the red (linear term only) and blue (linear and quadratic terms) fits are nearly identical. This corresponds with the relatively small coefficient estimate for the `I(pco2_first^2)` term. The  $p$ -value for this coefficient is about 0.86, and at the 0.05 significance level we would likely conclude that a quadratic

term is not necessary in our model to fit the data, as the linear term only model fits the data nearly as well.

### *Statistical Interactions and Testing Nested Models*

We have concluded that a linear (straight line) model fit the data quite well, but thus far we have restricted our exploration to just one variable at a time. When we include other variables, we may wonder if the same straight line is true for all patients. For example, could the relationship between PCO<sub>2</sub> and TCO<sub>2</sub> be different among men and women? We could subset the data into a data frame for men and a data frame for women, and then fit separate regressions for each gender. Another more efficient way to accomplish this is by fitting both genders in a single model, and including gender as a covariate. For example, we may fit:

$$\text{tco2\_first} = \beta_0 + \beta_1 \times \text{pco2\_first} + \beta_2 \times \text{gender\_num}.$$

The variable `gender_num` takes on values 0 for women and 1 for men, and for men the model is:

$$\text{tco2\_first} = \underbrace{(\beta_0 + \beta_2)}_{\text{intercept}} + \beta_1 \times \text{pco2\_first},$$

and in women:

$$\text{tco2\_first} = \beta_0 + \beta_1 \times \text{pco2\_first}.$$

As one can see these models have the same slope, but different intercepts (the distance between the slopes is  $\beta_2$ ). In other words, the lines fit for men and women will be parallel and be separated by a distance of  $\beta_2$  for all values of `pco2_first`. This isn't exactly what we would like, as the slopes may also be different. To allow for this, we need to discuss the idea of an interaction between two variables. An interaction is essentially the product of two covariates. In this case, which we will call the interaction model, we would be fitting:

$$\text{tco2\_first} = \beta_0 + \beta_1 \times \text{pco2\_first} + \beta_2 \times \text{gender\_num} + \beta_3 \times \underbrace{\text{gender\_num} \times \text{pco2\_first}}_{\text{interaction term}}.$$

Again, separating the cases for men:

$$\text{tco2\_first} = \underbrace{(\beta_0 + \beta_2)}_{\text{intercept}} + \underbrace{(\beta_1 + \beta_3)}_{\text{slope}} \times \text{pco2\_first},$$

and women:

$$\text{tco2\_first} = \underbrace{(\beta_0)}_{\text{intercept}} + \underbrace{(\beta_1)}_{\text{slope}} \times \text{pco2\_first}.$$

Now men and women have different intercepts *and* slopes.

Fitting these models in R is relatively straightforward. Although not absolutely required in this particular circumstance, it is wise to make sure that R handles data types in the correct way by ensuring our variables are of the right class. In this particular case, men are coded as 1 and women as 0 (a discrete binary covariate) but R thinks this is numeric (continuous) data:

```
class(dat$gender_num)
```

```
## [1] "integer"
```

Leaving this unaltered, will not affect the analysis in this instance, but it can be problematic when dealing with other types of data such as categorical data with several categories (e.g., ethnicity). Also, by setting the data to the right type, the output R generates can also be more informative. We can set the `gender_num` variable to the class `factor` by using the `as.factor` function.

```
dat$gender_num <- as.factor(dat$gender_num)
```

Here we have just overwritten the old variable in the `dat` data frame with a new copy which is of class

```
factor:
```

```
class(dat$gender_num)
```

```
## [1] "factor"
```

Now that we have the gender variable correctly encoded, we can fit the models we discussed above. First the model with gender as a covariate, but no interaction. We can do this by simply adding the variable `gender_num` to the previous formula for our `co2.lm` model fit.



```
co2.gender.lm <- lm(tco2_first ~ pco2_first + gender_num,data=dat)
summary(co2.gender.lm)$coef
```

```
##           Estimate Std. Error  t value    Pr(>|t|)
## (Intercept) 16.3043942 0.377712532 43.1661457 6.337240e-270
## pco2_first   0.1888542 0.007894741 23.9215128 3.015777e-108
## gender_num1 -0.1816540 0.223738366 -0.8119036 4.169687e-01
```

This output is very similar to what we had before, but now there's a `gender_num` term as well. The 1 is present in the first column after `gender_num`, and it tells us who this coefficient is relevant to (subjects with 1 for the `gender_num` – men). This is always relative to the baseline group, and in this case this is women.

The estimate is negative, meaning that the line fit for males will be below the line for females. Plotting this fit curve in Fig. 16.3:

```
plot(dat$pco2_first, dat$tco2_first, col = dat$gender_num, xlab = "PCO2", ylab = "TCO2",
      xlim = c(0, 40), type = "n", ylim = c(15, 25))
abline(a = c(coef(co2.gender.lm)[1]), b = coef(co2.gender.lm)[2])
abline(a = coef(co2.gender.lm)[1] + coef(co2.gender.lm)[3], b = coef(co2.gender.lm)[2],
      col = "red")
```

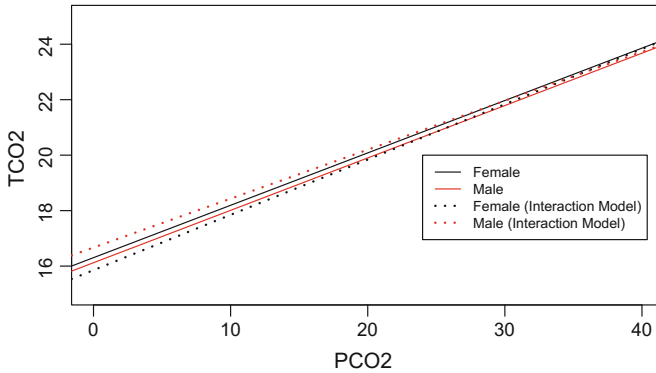
we see that the lines are parallel, but almost indistinguishable. In fact, this plot has been cropped in order to see any difference at all. From the estimate from the `summary` output above, the difference between the two lines is  $-0.182$  mmol/L, which is quite small, so perhaps this isn't too surprising. We can also see in the above `summary` output that the  $p$ -value is about 0.42, and we would likely *not* reject the null hypothesis that the true value of the `gender_num` coefficient is zero.

And now moving on to the model with an interaction between `pco2_first` and `gender_num`. To add an interaction between two variables use the `*` operator within a model formula. By default, R will add all of the main effects (variables contained in the interaction) to the model as well, so simply adding `pco2_first*gender_num` will add effects for `pco2_first` and `gender_num` in addition to the interaction between them to the model fit.

```
co2.gender.interaction.lm <- lm(tco2_first ~ pco2_first*gender_num,data=dat)
summary(co2.gender.interaction.lm)$coef
```

```
##           Estimate Std. Error  t value    Pr(>|t|)
## (Intercept) 15.85443226 0.48869107 32.442648 1.591490e-177
## pco2_first   0.19939518 0.01072876 18.585105 6.559901e-70
## gender_num1  0.81437833 0.72225677  1.127547 2.596819e-01
## pco2_first:gender_num1 -0.02297002 0.01583758 -1.450348 1.471591e-01
```

The estimated coefficients are  $\hat{\beta}_0$ ,  $\hat{\beta}_1$ ,  $\hat{\beta}_2$  and  $\hat{\beta}_3$ , respectively, and we can determine the best fit lines for men:



**Fig. 16.3** Regression fits of PCO<sub>2</sub> on TCO<sub>2</sub> with gender (*black* female; *red* male; *solid* no interaction; *dotted* with interaction). *Note* Both axes are cropped for illustration purposes

$$\begin{aligned} \text{tco2\_first} &= (15.85 + 0.81) + (0.20 - 0.023) \times \text{pco2\_first} \\ &= 16.67 + 0.18 \times \text{pco2\_first}, \end{aligned}$$

and for women:

$$\text{tco2\_first} = 15.85 + 0.20 \times \text{pco2\_first}.$$

Based on this, the men's intercept should be higher, but their slope should be not as steep, relative to the women. Let's check this and add the new model fits as dotted lines and add a legend to Fig. 16.3.

```
abline(a = coef(co2.gender.interaction.lm)[1], b = coef(co2.gender.interaction.lm)[2],
       lty = 3, lwd = 2)
abline(a = coef(co2.gender.interaction.lm)[1] + coef(co2.gender.interaction.lm)[3],
       b = coef(co2.gender.interaction.lm)[2] + coef(co2.gender.interaction.lm)[4],
       col = "red", lty = 3, lwd = 2)
legend(24, 20, lty = c(1, 1, 3, 3), lwd = c(1, 1, 2, 2), col = c("black", "red",
"black", "red"), c("Female", "Male", "Female (Interaction Model)", "Male (Interaction Model)"))
```

We can see that the fits generated from this plot are a little different than the one generated for a model without the interaction. The biggest difference is that the dotted lines are no longer parallel. This has some serious implications, particularly when it comes to interpreting our result. First note that the estimated coefficient for the `gender_num` variable is now positive. This means that at `pco2_first = 0`, men (red) have higher `tco2_first` levels than women (black). If you recall in the previous model fit, women had higher levels of `tco2_first` at all levels of `pco2_first`. At some point around `pco2_first = 35` this changes and women (black) have higher `tco2_first` levels than men (red). This means that the effect of `gender_num` may vary as you change the level of `pco2_first`, and is why interactions are often referred to as effect modification in the epidemiological

literature. The effect need not change signs (i.e., the lines do not need to cross) over the observed range of values for an interaction to be present.

The question remains, is the variable `gender_num` important? We looked at this briefly when we examined the `t value` column in the no interaction model which included `gender_num`. What if we wanted to test (simultaneously) the null hypothesis:  $\beta_2$  and  $\beta_3 = 0$ . There is a useful test known as the F-test which can help us in this exact scenario where we want to look at if we should use a larger model (more covariates) or use a smaller model (fewer covariates). The F-test applies only to *nested models*—the larger model *must* contain each covariate that is used in the smaller model, and the smaller model *cannot* contain covariates which are not in the larger model. The interaction model and the model with gender are nested models since all the covariates in the model with gender are also in the larger interaction model. An example of a non-nested model would be the quadratic model and the interaction model: the smaller (quadratic) model has a term (`pco2_first2`) which is not in the larger (interaction) model. An F-test would not be appropriate for this latter case.

To perform an F-test, first fit the two models you wish to consider, and then run the `anova` command passing the two model objects.

```
anova(co2.lm,co2.gender.interaction.lm)

## Analysis of Variance Table
##
## Model 1: tco2_first ~ pco2_first
## Model 2: tco2_first ~ pco2_first * gender_num
##   Res.Df  RSS Df Sum of Sq    F Pr(>F)
## 1    1588 30674
## 2    1586 30621   2    53.349 1.3816 0.2515
```

As you can see, the `anova` command first lists the models it is considering. Much of the rest of the information is beyond the scope of this chapter, but we will highlight the reported F-test *p*-value (`Pr(>F)`), which in this case is 0.2515. In nested models, the null hypothesis is that all coefficients in the larger model and not in the smaller model are zero. In the case we are testing, our null hypothesis is  $\beta_2$  and  $\beta_3 = 0$ . Since the *p*-value exceeds the typically used significance level ( $\alpha = 0.05$ ), we would not reject the null hypothesis, and likely say the smaller model explains the data just as well as the larger model. If these were the only models we were considering, we would use the smaller model as our final model and report the final model in our results. We will now discuss what exactly you should report and how you can interpret the results.

### 16.2.4 Reporting and Interpreting Linear Regression

We will briefly discuss how to communicate a linear regression analysis. In general, before you present the results, some discussion of how you got the results should be done. It is a good idea to report: whether you transformed the outcome or any covariates in anyway (e.g., by taking the logarithm), what covariates you considered and how you chose the covariates which were in the model you reported. In our above example, we did not transform the outcome (TCO2), we considered PCO2 both as a linear and quadratic term, and we considered gender on its own and as an interaction term with PCO2. We first evaluated whether a quadratic term should be included in the model by using a t-test, after which we considered a model with gender and a gender-PCO2 interaction, and performed model selection with an F-test. Our final model involved only a linear PCO2 term and an intercept.

When reporting your results, it's a good idea to report three aspects for each covariate. Firstly, you should always report the coefficient estimate. The coefficient estimate allows the reader to assess the magnitude of the effect. There are many circumstances where a result may be statistically significant, but practically meaningless. Secondly, alongside your estimate you should always report some measure of uncertainty or precision. For linear regression, the standard error (Std. Error column in the R output) can be reported. We will cover another method called a confidence interval later on in this section. Lastly, reporting a  $p$ -value for each of the coefficients is also a good idea. An example of appropriate presentation of our final model would be something similar to: TCO2 increased 0.18 (SE: 0.008,  $p$ -value <0.001) units per unit increase of PCO2. You will note we reported  $p$ -value <0.001, when in fact it is smaller than this. It is common to report very small  $p$ -values as <0.001 or <0.0001 instead of using a large number of decimal places. While sometimes it's simply reported whether  $p < 0.05$  or not (i.e., if the result is statistically significant or not), this practice should be avoided.

Often it's a good idea to also discuss how well the overall model fit. There are several ways to accomplish this, but reporting a unitless quantity known as  $R^2$  (pronounced r-squared) is often done. Looking back to the output R provided for our chosen final model, we can find the value of  $R^2$  for this model under Multiple R-squared: 0.2647. This quantity is a proportion (a number between 0 and 1), and describes how much of the total variability in the data is explained by the model. An  $R^2$  of 1 indicates a perfect fit, where 0 explains no variability in the data. What exactly constitutes a 'good'  $R^2$  depends on subject matter and how it will be used. Another way to describe the fit in your model is through the residual standard error. This is also in the `lm` output when using the `summary` function. This roughly estimates square-root of the average squared distance between the model fit and the data. While it is in the same units as the outcome, it is in general more difficult to interpret than  $R^2$ . It should be noted that for evaluating prediction error, these values are likely too optimistic when applied to new data, and a better estimate of the error should be evaluated by other methods (e.g., cross-validation), which will be covered in another chapter and elsewhere [4, 5].

### ***Interpreting the Results***

Interpreting the results is an important component to any data analysis. We have already covered interpreting the intercept, which is the prediction for the outcome when all covariates are set at zero. This quantity is not of direct interest in most studies. If one does want to interpret it, subtracting the mean from each of the model's covariates will make it more interpretable—the expected value of the outcome when all covariates are set to the study's averages.

The coefficient estimates for the covariates are in general the quantities most of scientific interest. When the covariate is binary (e.g., `gender_num`), the coefficient represents the difference between one level of the covariate (1) relative to the other level (0), while holding any other covariates in the model constant. Although we won't cover it until the next section, extending discrete covariates to the case when they have more than two levels (e.g., ethnicity or `service_unit`) is quite similar, with the noted exception that it's important to reference the baseline group (i.e., what is the effect relative to). We will return to this topic later on in the chapter. Lastly, when the covariate is continuous the interpretation is the expected change in the outcome as a result of increasing the covariate in question by one unit, while holding all other covariates fixed. This interpretation is actually universal for any non-intercept coefficient, including for binary and other discrete data, but relies more heavily on understanding how R is coding these covariates with dummy variables.

We examined statistical interactions briefly, and this topic can be very difficult to interpret. It is often advisable, when possible, to represent the interaction graphically, as we did in Fig. 16.3.

### ***Confidence and Prediction Intervals***

As mentioned above, one method to quantify the uncertainty around coefficient estimates is by reporting the standard error. Another commonly used method is to report a confidence interval, most commonly a 95 % confidence interval. A 95 % confidence interval for  $\beta$  is an interval for which if the data were collected repeatedly, about 95 % of the *intervals* would contain the *true value* of the parameter,  $\beta$ , assuming the modeling assumptions are correct.

To get 95 % confidence intervals of coefficients, R has a `confint` function, which you pass an `lm` object to. It will then output 2.5 and 97.5 % confidence interval limits for each coefficient.

```
confint(co2.lm)

##              2.5 %      97.5 %
## (Intercept) 15.5053693 16.9163494
## pco2_first  0.1731033  0.2040403
```

The 95 % confidence interval for `pco2_first` is about 0.17–0.20, which may be slightly more informative than reporting the standard error. Often people will look at if the confidence interval includes zero (no effect). Since it does not, and in

fact since the interval is quite narrow and not very close to zero, this provides some additional evidence of its importance. There is a well known link between hypothesis testing and confidence intervals which we will not get into detail here.

When plotting the data with the model fit, similar to Fig. 16.2, it is a good idea to include some sort of assessment of uncertainty as well. To do this in R, we will first create a data frame with PCO2 levels which we would like to predict. In this case, we would like to predict the outcome (TCO2) over the range of observed covariate (PCO2) values. We do this by creating a data frame, where the variable names in the data frame must match the covariates used in the model. In our case, we have only one covariate (`pco2_first`), and we predict the outcome over the range of covariate values we observed determined by the `min` and `max` functions.

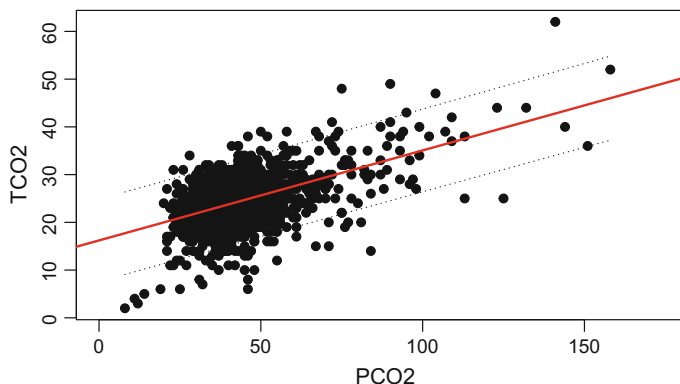
```
grid.pred <- data.frame(pco2_first=seq.int(from=min(dat$pco2_first,na.rm=T),
                                          to=max(dat$pco2_first,na.rm=T)));
```

Then, by using the `predict` function, we can predict TCO2 levels at these PCO2 values. The `predict` function has three arguments: the model we have constructed (in this case, using `lm`), `newdata`, and `interval`. The `newdata` argument allows you to pass any data frame with the same covariates as the model fit, which is why we created `grid.pred` above. Lastly, the `interval` argument is optional, and allows for the inclusion of any confidence or prediction intervals. We want to illustrate a prediction interval which incorporates both uncertainty about the model coefficients, in addition to the uncertainty generated by the data generating process, so we will pass `interval = "prediction"`.

```
preds <- predict(co2.lm,newdata=grid.pred,interval = "prediction")
preds[1:2,]
```

```
##      fit      lwr      upr
## 1 17.71943 9.078647 26.36022
## 2 17.90801 9.268186 26.54783
```

We have printed out the first two rows of our predictions, `preds`, which are the model's predictions for PCO2 at 8 and 9. We can see that our predictions (`fit`) are about 0.18 apart, which make sense given our estimate of the slope (0.18). We also see that our 95 % prediction intervals are very wide, spanning about 9 (`lwr`) to 26 (`upr`). This indicates that, despite coming up with a model which is very statistically significant, we still have a lot of uncertainty about the predictions generated from such a model. It is a good idea to capture this quality when plotting how well your model fits by adding the interval lines as dotted lines. Let's plot our final model fit, `co2.lm`, along with the scatterplot and prediction interval in Fig. 16.4.



**Fig. 16.4** Scatterplot of PCO<sub>2</sub> (x-axis) and TCO<sub>2</sub> (y-axis) along with linear regression estimates from the linear only model (`co2.lm`). The *dotted line* represents 95 % prediction intervals for the model

```
plot(dat$pco2_first,dat$tco2_first,xlab="PCO2",ylab="TCO2",pch=19,xlim=c(0,175))
co2.lm <- lm(tco2_first ~ pco2_first,data=dat)
abline(co2.lm,col='red',lwd=2)
lines(grid.pred$pco2_first,preds[,2],lty=3)
lines(grid.pred$pco2_first,preds[,3],lty=3)
```

### 16.2.5 Caveats and Conclusions

Linear regression is an extremely powerful tool for doing data analysis on continuous outcomes. Despite this, there are several aspects to be aware of when performing this type of analysis.

1. Hypothesis testing and the interval generation are reliant on modelling assumptions. Doing diagnostic plots is a critical component when conducting data analysis. There is subsequent discussion on this elsewhere in the book, and we will refer you to [6–8] for more information about this important topic.
2. Outliers can be problematic when fitting models. When there are outliers in the covariates, it's often easiest to turn a numeric variable into a categorical one (2 or more groups cut along values of the covariate). Removing outliers should be avoided when possible, as they often tell you a lot of information about the data generating process. In other cases, they may identify problems for the extraction process. For instance, a subset of the data may use different units for the same covariate (e.g., inches and centimeters for height), and thus the data needs to be converted to common units. Methods robust to outliers are available in R, a brief introduction of how to get started with some of the functions in R is available [7].

3. Be concerned about missing data. R reports information about missing data in the `summary` output. For our model fit `co2.lm`, we had 186 observations with missing `pco2_first` observations. R will leave these observations out of the analysis, and fit on the remaining non-missing observations. Always check the output to ensure you have as many observations as you think that you are supposed to. When many observations have missing data and you try to build a model with a large number of coefficients, you may be fitting the model on only a handful of observations.
4. Assess potential multi-collinearity. Co-linearity can occur when two or more covariates are highly correlated. For instance, if blood pressure on the left and right arms were simultaneously measured, and both used as covariates in the model. In this case, consider taking the sum, average or difference (whichever is most useful in the particular case) to craft a single covariate. Co-linearity can also occur when a categorical variable has been improperly generated. For instance, defining groups along the PCO2 covariate of 0–25, 5–26, 26–50, >50 may cause linear regression to encounter some difficulties as the first and second groups are nearly identical (usually these types of situations are programming errors). Identifying covariates which may be colinear is a key part of the exploratory analysis stage, where they can often (but not always) be seen by plotting the data.
5. Check to see if outcomes are dependent. This most commonly occurs when one patient contributes multiple observations (outcomes). There are alternative methods for dealing with this situation [9], but it is beyond the scope of this chapter.

These concerns should not discourage you from using linear regression. It is extremely powerful and reasonably robust to some of the problems discussed above, depending on the situation. Frequently a continuous outcome is converted to a binary outcome, and often there is no compelling reason this is done. By discretizing the outcome you may be losing information about which patients may benefit or be harmed most by a therapy, since a binary outcome may treat patients who had very different outcomes on the continuous scale as the same. The overall framework we took in linear regression will closely mirror the way in which we approach the other analysis techniques we discuss later in this chapter.

## 16.3 Logistic Regression

### 16.3.1 Section Goals

In this section, the reader will learn the fundamentals of logistic regression, and how to present and interpret such an analysis.



## 16.3.2 Introduction

In Sect. 16.2 we covered a very useful methodology for modeling quantitative or continuous outcomes. We of course know though that health outcomes come in all different kinds of data types. In fact, the health outcomes we often care about most—cured/not cured, alive/dead, are discrete binary outcomes. It would be ideal if we could extend the same general framework for continuous outcomes to these binary outcomes. Logistic regression allows us to incorporate much of what we learned in the previous section and apply the same principles to binary outcomes.

When dealing with binary data, we would like to be able to model the probability of a type of outcome given one or more covariates. One might ask, why not just simply use linear regression? There are several reasons why this is generally a bad idea. Probabilities need to be somewhere between zero and one, and there is nothing in linear regression to constrain the estimated probabilities to this interval. This would mean that you could have an estimated probability 2, or even a negative probability! This is one unattractive property of such a method (there are others), and although it is sometimes used, the availability of good software such as R allows us to perform better analyses easily and efficiently. Before introducing such software, we should introduce the analysis of small contingency tables.

### 16.3.3 $2 \times 2$ Tables

Contingency tables are the best way to start to think about binary data. A contingency table cross-tabulates the outcome across two or more levels of a covariate. Let's begin by creating a new variable (`age.cat`) which dichotomizes age into two age categories:  $\leq 55$  and  $> 55$ . Note, because we are making age a discrete variable, we also change the data type to a factor. This is similar to what we did for the `gender_num` variable when discussing linear regression in the previous section. We can get a breakdown of the new variable using the `table` function.

```
dat$age.cat <- as.factor(ifelse(dat$age<=55, "<=55", ">55"))
table(dat$age.cat)
```

```
##
## <=55 >55
## 923 853
```

We would like to see how 28 day mortality is distributed among the age categories. We can do so by constructing a contingency table, or in this case what is commonly referred to as a  $2 \times 2$  table.

```
table(dat$age.cat, dat$day_28_flg)
```

```
##
##           0  1
## <=55 883  40
## >55  610 243
```

From the above table, you can see that 40 patients in the young group ( $\leq 55$ ) died within 28 days, while 243 in the older group died. These correspond to  $P(\text{die}|\text{age} \leq 55) = 0.043$  or 4.3 % and  $P(\text{die}|\text{age} > 55) = 0.284$  or 28.4 %, where the “|” can be interpreted as “given” or “for those who have.” This difference is quite marked, and we know that age is an important factor in mortality, so this is not surprising.

The odds of an event happening is a positive number and can be calculated from the probability of an event,  $p$ , by the following formula

$$\text{Odds} = \frac{p}{1-p}.$$

An event with an odds of zero never happens, and an event with a very large odds ( $>100$ ) is very likely to happen. Here, the odds of dying within 28 days in the young group is  $0.043/(1 - 0.043) = 0.045$ , and in the older group is  $0.284/(1 - 0.284) = 0.40$ . It is convenient to represent these two figures as a ratio, and the choice of what goes in the numerator and the denominator is somewhat arbitrary. In this case, we will choose to put the older group’s odds on the numerator and the younger in the denominator, and it’s important to make it clear which group is in the numerator and denominator in general. In this case the *Odds ratio* is  $0.40/0.045 = 8.79$ , which indicates a very strong association between age and death, and means that the odds of dying in the older group is nearly 9 fold higher than when compared to the younger group. There is a convenient shortcut for doing odds ratio calculation by making an X on a  $2 \times 2$  table and multiplying top left by bottom right, then dividing it by the product of bottom left and top right. In this case  $\frac{883 \times 243}{610 \times 40} = 8.79$ .

Now let us look at a slightly different case—when the covariate takes on more than two values. Such a variable is the `service_unit`. Let’s see how the deaths are distributed among the different units:

```
deathbyservice <- table(dat$service_unit, dat$day_28_flg)
deathbyservice
```

```
##
##           0  1
## FICU  59  3
## MICU 605 127
## SICU 829 153
```

we can get frequencies of these service units by applying the `prop.table` function to our cross-tabulated table.

```
dbys.proptable <- prop.table(deathbyservice,1)
dbys.proptable
```

```
##
##           0           1
## FICU 0.9516129 0.0483871
## MICU 0.8265027 0.1734973
## SICU 0.8441955 0.1558045
```

It appears as though the FICU may have a lower rate of death than either the MICU or SICU. To compute an odds ratios, first compute the odds:

```
dbys.proptable[, "1"]/dbys.proptable[, "0"]
```

```
##      FICU      MICU      SICU
## 0.05084746 0.20991736 0.18455971
```

and then we need to pick which of FICU, MICU or SICU will serve as the reference or baseline group. This is the group which the other two groups will be compared to. Again the choice is arbitrary, but should be dictated by the study objective. If this were a clinical trial with two drug arms and a placebo arm, it would be foolish to use one of the treatments as the reference group, particularly if you wanted to compare the efficacy of the treatments. In this particular case, there is no clear reference group, but since the FICU is so much smaller than the other two units, we will use it as the reference group. Computing the odds ratio for MICU and SICU we get 4.13 and 3.63, respectively. These are also very strong associations, meaning that the odds of dying in the SICU and MICU are around 4 times higher than in the FICU, but relatively similar.

Contingency tables and  $2 \times 2$  tables in particular are the building blocks of working with binary data, and it's often a good way to begin looking at the data.

### 16.3.4 *Introducing Logistic Regression*

While contingency tables are a fundamental way of looking at binary data, they are somewhat limited. What happens when the covariate of interest is continuous? We could of course create categories from the covariate by establishing cut points, but we may still miss some important aspect of the relationship between the covariate and the outcome by not choosing the right cut points. Also, what happens when we know that a nuisance covariate is related to both the outcome and the covariate of interest. This type of nuisance variable is called a confounder and occurs frequently

in observational data, and although there are ways of accounting for confounding in contingency tables, they become more difficult to use when there are more than one present.

Logistic regression is a way of addressing both of these issues, among many others. If you recall, using linear regression is problematic because it is prone to estimating probabilities outside of the  $[0, 1]$  range. Logistic regression has no such problem per se, because it uses a link function known as the logit function which maps probabilities in the interval  $[0, 1]$  to a real number  $(-\infty, \infty)$ . This is important for many practical and technical reasons. The logit of  $p_x$  (i.e. the probability of an event for certain covariate values  $x$ ) is related to the covariates in the following way

$$\text{logit}(p_x) = \log(\text{Odds}_x) = \log\left(\frac{p_x}{1 - p_x}\right) = \beta_0 + \beta_1 \times x.$$

It is worth pointing out here that  $\log$  here, and in most places in statistics is referring to the natural logarithm, sometimes denoted  $\ln$ .

The first covariate we were considering, `age.cat` was also a binary variable, where it takes on values 1 when the `age > 55` and 0 when `age ≤ 55`. So plugging these values in, first for the young group ( $x = 0$ ):

$$\text{logit}(p_{x=0}) = \log(\text{Odds}_{x=0}) = \log\left(\frac{p_{x=0}}{1 - p_{x=0}}\right) = \beta_0 + \beta_1 \times 0 = \beta_0,$$

and then for the older group ( $x = 1$ ):

$$\text{logit}(p_{x=1}) = \log(\text{Odds}_{x=1}) = \log\left(\frac{p_{x=1}}{1 - p_{x=1}}\right) = \beta_0 + \beta_1 \times 1 = \beta_0 + \beta_1.$$

If we subtract the two cases  $\text{logit}(p_{x=1}) - \text{logit}(p_{x=0}) = \log(\text{Odds}_{x=1}) - \log(\text{Odds}_{x=0})$ , and we notice that this quantity is equal to  $\beta_1$ . If you recall the properties of logarithms, that the difference of two logs is the log of their ratio, so  $\log(\text{Odds}_{x=1}) - \log(\text{Odds}_{x=0}) = \log(\text{Odds}_{x=1}/\text{Odds}_{x=0})$ , which may be looking familiar. This is the log ratio of the odds or the *log odds ratio* in the  $x = 1$  group relative to the  $x = 0$  group. Hence, we can estimate odds ratios using logistic regression by exponentiating the coefficients of the model (the intercept notwithstanding, which we will get to in a moment).

Let's fit this model, and see how this works using a real example. We fit logistic regression very similarly to how we fit linear regression models, with a few exceptions. First, we will use a new function called `glm`, which is a very powerful function in R which allow one to fit a class of models known as generalized linear models or GLMs [10]. The `glm` function works in much the same way the `lm` function does. We need to specify a formula of the form: `outcome ~ covariates`, specify what dataset to use (in our case the `dat` data frame), and then specify the family. For logistic regression `family = 'binomial'` will be our choice. You can run the `summary` function, just like you did for `lm` and it produces output very similar to what `lm` did.

```

age.glm <- glm(day_28_flg ~ age.cat,data=dat,family="binomial")
summary(age.glm)

##
## Call:
## glm(formula = day_28_flg ~ age.cat, family = "binomial", data = dat)
##
## Deviance Residuals:
##      Min       1Q   Median       3Q      Max
## -0.8189 -0.8189 -0.2977 -0.2977  2.5055
##
## Coefficients:
##              Estimate Std. Error z value Pr(>|z|)
## (Intercept)  -3.0944     0.1616  -19.14  <2e-16 ***
## age.cat>55    2.1740     0.1785   12.18  <2e-16 ***
## ---
## Signif. codes:  0 '***' 0.001 '**' 0.01 '*' 0.05 '.' 0.1 ' ' 1
##
## (Dispersion parameter for binomial family taken to be 1)
##
##      Null deviance: 1557.9  on 1775  degrees of freedom
## Residual deviance: 1348.7  on 1774  degrees of freedom
## AIC: 1352.7
##
## Number of Fisher Scoring iterations: 5

```

As you can see, we get a coefficients table that is similar to the `lm` table we used earlier. Instead of a  $t$  value, we get a  $z$  value, but this can be interpreted similarly. The rightmost column is a  $p$ -value, for testing the null hypothesis  $\beta = 0$ . If you recall, the non-intercept coefficients are log-odds ratios, so testing if they are zero is equivalent to testing if the odds ratios are one. If an odds ratio is one the odds are equal in the numerator group and denominator group, indicating the probabilities of the outcome are equal in each group. So, assessing if the coefficients are zero will be an important aspect of doing this type of analysis.

Looking more closely at the coefficients. The intercept is  $-3.09$  and the `age.cat` coefficient is  $2.17$ . The coefficient for `age.cat` is the log odds ratio for the  $2 \times 2$  table we previously did the analysis on. When we exponentiate  $2.17$ , we get  $\exp(2.17) = 8.79$ . This corresponds with the estimate using the  $2 \times 2$  table. For completeness, let's look at the other coefficient, the intercept. If you recall,  $\log(\text{Odds}_{x=0}) = \beta_0$ , so  $\beta_0$  is the log odds of the outcome in the younger group. Exponentiating again,  $\exp(-3.09) = 0.045$ , and this corresponds with the previous analysis we did. Similarly,  $\log(\text{Odds}_{x=1}) = \beta_0 + \beta_1$ , and the estimated odds of 28 day death in the older group is  $\exp(-3.09 + 2.17) = 0.4$ , as was found above. Converting estimated odds into a probability can be done directly using the `plogis` function, but we will cover a more powerful and easier way of doing this later on in the section.

### ***Beyond a Single Binary Covariate***

While the above analysis is useful for illustration, it does not readily demonstrate anything we could not do with our  $2 \times 2$  table example above. Logistic regression allows us to extend the basic idea to at least two very relevant areas. The first is the

case where we have more than one covariate of interest. Perhaps we have a confounder, we are concerned about, and want to adjust for it. Alternatively, maybe there are two covariates of interest. Secondly, it allows use to use covariates as continuous quantities, instead of discretizing them into categories. For example, instead of dividing age up into exhaustive strata (as we did very simply by just dividing the patients into two groups,  $\leq 55$  and  $> 55$ ), we could instead use age as a continuous covariate.

First, having more than one covariate is simple. For example, if we wanted to add `service_unit` to our previous model, we could just add it as we did when using the `lm` function for linear regression. Here we specify `~day_28_flg age.cat + service_unit` and run the `summary` function.

```
ageunit.glm <- glm(day_28_flg ~ age.cat + service_unit,data=dat,family="binomial")
summary(ageunit.glm)$coef
```

```
##              Estimate Std. Error  z value    Pr(>|z|)
## (Intercept)  -4.209013  0.6222758 -6.763903 1.343230e-11
## age.cat>55    2.161142  0.1787575 12.089800 1.195779e-33
## service_unitMICU 1.178865  0.6151757  1.916307 5.532607e-02
## service_unitSICU 1.123442  0.6135095  1.831173 6.707466e-02
```

A coefficient table is produced, and now we have four estimated coefficients. The same two, `(Intercept)` and `age.cat` which were estimated in the unadjusted model, but also we have `service_unitMICU` and `service_unitSICU` which correspond to the log odds ratios for the MICU and SICU relative to the FICU. Taking the exponential of these will result in an odds ratio for each variable, adjusted for the other variables in the model. In this case the adjusted odds ratios for Age  $> 55$ , MICU and SICU are 8.68, 3.25, and 3.08, respectively. We would conclude that there is an almost 9-fold increase in the odds of 28 day mortality for those in the  $>55$  year age group relative to the younger  $\leq 55$  group while holding service unit constant. This adjustment becomes important in many scenarios where groups of patients may be more or less likely to receive treatment, but also more or less likely to have better outcomes, where one effect is confounded by possibly many others. Such is almost always the case with observational data, and this is why logistic regression is such a powerful data analysis tool in this setting.

Another case we would like to be able to deal with is when we have a continuous covariate we would like to include in the model. One can always break the continuous covariate into mutually exclusive categories by selecting `break` or `cut` points, but selecting the number and location of these points can be arbitrary, and in many cases unnecessary or inefficient. Recall that in logistic regression we are fitting a model:

$$\text{logit}(p_x) = \log(\text{Odds}_x) = \log\left(\frac{p_x}{1-p_x}\right) = \beta_0 + \beta_1 \times x,$$

but now assume  $x$  is continuous. Imagine a hypothetical scenario where you know  $\beta_0$  and  $\beta_1$  and have a group of 50 year olds, and a group of 51 year olds. The difference in the log Odds between the two groups is:

$$\begin{aligned} \log(\text{Odds}_{51}) - \log(\text{Odds}_{50}) &= (\beta_0 + \beta_1 \times 51) - (\beta_0 + \beta_1 \times 50) = \beta_1(51 - 50) \\ &= \beta_1. \end{aligned}$$

Hence, the odds ratio for 51 year olds versus 50 year olds is  $\exp(\beta_1)$ . This is actually true for any group of patients which are 1 year apart, and this gives a useful way to interpret and use these estimated coefficients for continuous covariates. Let's work with an example. Again fitting the 28 day mortality outcome as a function of age, but treating age as it was originally recorded in the dataset, a continuous variable called `age`.

```
agects.glm <- glm(day_28_flg ~ age, data=dat, family="binomial")
summary(agects.glm)$coef
```

```
##           Estimate Std. Error z value Pr(>|z|)
## (Intercept) -5.77800634  0.320774776  -18.01266  1.550034e-72
## age          0.06523274  0.004469569   14.59486  3.028256e-48
```

We see the estimated coefficient is 0.07 and still very statistically significant. Exponentiating the log odds ratio for age, we get an estimated odds ratio of 1.07, which is per 1 year increase in age. What if the age difference of interest is ten years instead of one year? There are at least two ways of doing this. One is to replace `age` with  $\mathbb{I}(\text{age}/10)$ , which uses a new covariate which is `age` divided by ten. The second is to use the `agects.glm` estimated log odds ratio, and multiple by ten prior to exponentiating. They will yield equivalent estimates of 1.92, but it is now per 10 year increases in age. This is useful when the estimated odds ratios (or log odds ratios) are close to one (or zero). When this is done, one unit of the covariate is 10 years, so the generic interpretation of the coefficients remains the same, but the units (per 10 years instead of per 1 year) changes.

This of course assumes that the form of our equation relating the log odds of the outcome to the covariate is correct. In cases where odds of the outcome decreases and increases as a function of the covariate, it is possible to estimate a relatively small effect of the linear covariate, when the outcome may be strongly affected by the covariate, but not in the way the model is specified. Assessing the linearity of the log odds of the outcome and some discretized form of the covariate can be done graphically. For instance, we can break `age` into 5 groups, and estimate the log odds of 28 day mortality in each group. Plotting these quantities in Fig. 16.5 (left), we can see in this particular case, `age` is indeed strongly related to the odds of the outcome. Further, expressing `age` linearly appears like it would be a good

approximation. If on the other hand, 28 day mortality has more of a “U”-shaped curve, we may falsely conclude that no relationship between age and mortality exists, when the relationship may be rather strong. Such may be the case when looking at the the log odds of mortality by the first temperature (`temp_1st`) in Fig. 16.5 (right).

### 16.3.5 Hypothesis Testing and Model Selection

Just as in the case for linear regression, there is a way to test hypotheses for logistic regression. It follows much of the same framework, with the null hypothesis being  $\beta = 0$ . If you recall, this is the log odds ratio, and testing if it is zero is equivalent to a test for the odds ratio being equal to one. In this chapter, we focus on how to conduct such a test in R.

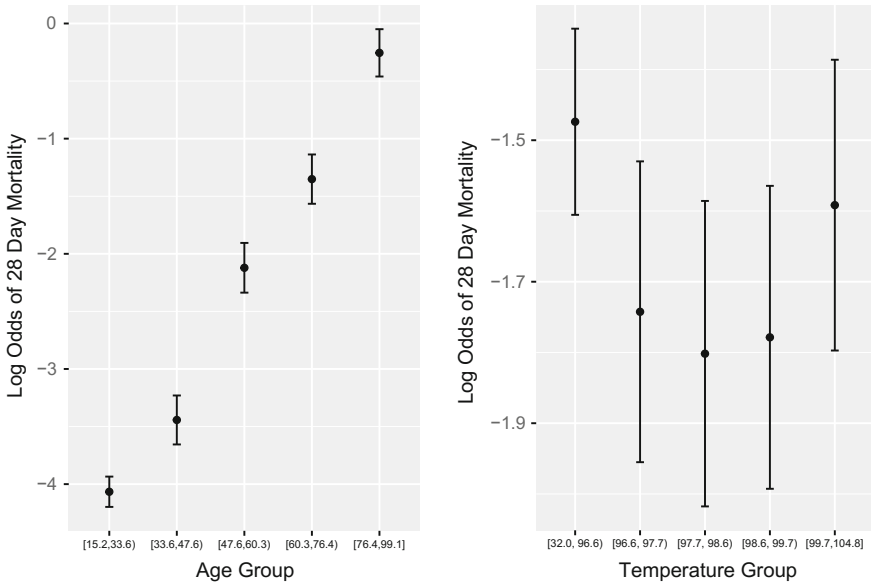
As was the case when using `lm`, we first fit the two competing models, a larger (alternative model), and a smaller (null model). Provided that the models are nested, we can again use the `anova` function, passing the smaller model, then the larger model. Here our larger model is the one which contained `service_unit` and `age.cat`, and the smaller only contains `age.cat`, so they are nested. We are then testing if the log odds ratios for the two coefficients associated with `service_unit` are zero. Let’s call these coefficients  $\beta_{MICU}$  and  $\beta_{SICU}$ . To test if  $\beta_{MICU}$  and  $\beta_{SICU} = 0$ , we can use the `anova` function, where this time we will specify the type of test, in this case set the `test` parameter to “Chisq”.

```
anova(age.glm,ageunit.glm,test="Chisq")

## Analysis of Deviance Table
##
## Model 1: day_28_flg ~ age.cat
## Model 2: day_28_flg ~ age.cat + service_unit
##   Resid. Df Resid. Dev Df Deviance Pr(>Chi)
## 1      1774      1348.7
## 2      1772      1343.8  2    4.9315  0.08495 .
## ---
## Signif. codes:  0 '***' 0.001 '**' 0.01 '*' 0.05 '.' 0.1 ' ' 1
```

Here the output of the `anova` function when applied to `glm` objects looks similar to the output generated when used on `lm` objects. A couple good practices to get in a habit are to first make sure the two competing models are correctly specified. Here we are testing `~ age.cat` versus `age.cat + service_unit`. Next, the difference between the residual degrees of freedom (`Resid. Df`) in the two models tell us how many more parameters the larger model has when compared





**Fig. 16.5** Plot of log-odds of mortality for each of the five age and temperature groups. *Error bars* represent 95 % confidence intervals for the log odds

to the smaller model. Here we see  $1774 - 1772 = 2$  which means that there are two more coefficients estimated in the larger model than the smaller one, which corresponds with the output from the `summary` table above. Next looking at the  $p$ -value ( $\Pr(>\text{Chi})$ ), we see a test for  $\beta_{MICU}$  and  $\beta_{SICU} = 0$  has a  $p$ -value of around 0.08. At the typical 0.05 significance level, we would not reject the null, and use the simpler model without the service unit. In logistic regression, this is a common way of testing whether a categorical covariate should be retained in the model, as it can be difficult to assess using the  $z$  value in the `summary` table, particularly when one is very statistically significant, and one is not.

### 16.3.6 Confidence Intervals

Generating confidence intervals for either the log-odds ratios or the odds ratios are relatively straightforward. To get the log-odds ratios and respective confidence intervals for the `ageunit.glm` model which includes both age and service unit.

```
ageunit.glm$coef
##      (Intercept)      age.cat>55 service_unitMICU service_unitSICU
##      -4.209013         2.161142         1.178865         1.123442
confint(ageunit.glm)
##              2.5 %      97.5 %
## (Intercept) -5.66202924 -3.139732
## age.cat>55  1.82211403  2.524682
## service_unitMICU 0.12291680 2.620797
## service_unitSICU 0.07182767 2.563132
```

Here the coefficient estimates and confidence intervals are presented in much the same way as for a linear regression. In logistic regression, it is often convenient to exponentiate these quantities to get it on a more interpretable scale.

```
exp(ageunit.glm$coef[-1])
##      age.cat>55 service_unitMICU service_unitSICU
##      8.681049         3.250684         3.075423
exp(confint(ageunit.glm)[-1,])
##              2.5 %      97.5 %
## age.cat>55  6.18492 12.48693
## service_unitMICU 1.13079 13.74668
## service_unitSICU 1.07447 12.97640
```

Similar to linear regression, we will look at if the confidence intervals for the log odds ratios include zero. This is equivalent to seeing if the intervals for the odds ratios include 1. Since the odds ratios are more directly interpretable it is often more convenient to report them instead of the coefficients on the log odds ratio scale.

### 16.3.7 Prediction

Once you have decided on your final model, you may want to generate predictions from your model. Such a task may occur when doing a propensity score analysis (Chap. 25) or creating tools for clinical decision support. In the logistic regression setting this involves attempting to estimate the probability of the outcome given the characteristics (covariates) of a patient. This quantity is often denoted  $P(\text{outcome}|X)$ . This is relatively easy to accomplish in R using the `predict` function. One must pass a dataset with all the variables contained in the model. Let's assume that we decided to include the `service_unit` in our final model, and want to generate predictions from this based on a new set of patients. Let's first

create a new data frame called `newdat` using the `expand.grid` function which computes all combinations of the values of variables passed to it.

```
newdat <- expand.grid(age.cat=c("<=55",">55"),service_unit=c("FICU","MICU","SICU"))
newdat$pred <- predict(ageunit.glm,newdata=newdat,type="response")
newdat
```

```
##  age.cat service_unit      pred
##  1    <=55      FICU 0.01464341
##  2    >55      FICU 0.11426771
##  3    <=55      MICU 0.04608233
##  4    >55      MICU 0.29546130
##  5    <=55      SICU 0.04370639
##  6    >55      SICU 0.28405645
```

We followed this by adding a `pred` column to our new data frame by using the `predict` function. The `predict` function for logistic regression works similar to when we used it for linear regression, but this time we also specify `type = "response"` which ensures the quantities computed are what we need,  $P(\text{outcome}|X)$ . Outputting this new object shows our predicted probability of 28 day mortality for six hypothetical patients. Two in each of the service units, where one is in the younger group and another in the older group. We see that our lowest prediction is for the youngest patients in the FICU, while the patients with highest risk of 28 day mortality are the older group in the MICU, but the predicted probability is not all that much higher than the same age patients in the SICU.

To do predictions on a different dataset, just replace the `newdata` argument with the other dataset. We could, for instance, pass `newdata = dat` and receive predictions for the dataset we built the model on. As was the case with linear regression, evaluating the predictive performance of our model on data used to build the model will generally be too optimistic as to how well it would perform *in the real world*. How to get a better sense of the accuracy of such models is covered in Chap. 17.

### 16.3.8 Presenting and Interpreting Logistic Regression Analysis

In general, presenting the results from a logistic regression model will follow quite closely to what was done in the linear regression setting. Results should always be put in context, including what variables were considered and which variables were in the final model. Reporting the results should always include some form of the coefficient estimate, a measure of uncertainty and likely a  $p$ -value. In medical and epidemiological journals, coefficients are usually exponentiated so that they are no longer on the log scale, and reported as odds ratios. Frequently, multivariable analyses (analysis with more than one covariate) is distinguished from univariate

analyses (one covariate) by denoting the estimated odds ratios as adjusted odds ratios (AOR).

For the `age.glm` model, an example of what could be reported is:

Mortality at 28 days was much higher in the older ( $> 55$  years) group than the younger group ( $\leq 55$  years), with rates of 28.5 and 4.3 %, respectively (OR = 8.79, 95 % CI: 6.27-12.64,  $p < 0.001$ ).

When treating age as a continuous covariate in the `agects.glm` model we could report:

Mortality at 28 days was associated with older age (OR = 1.07 per year increase, 95 % CI: 1.06-1.08,  $p < 0.001$ ).

And for the case with more than one covariate, (`ageunit.glm`) an example of what could be reported:

Older age ( $> 55$  versus  $\leq 55$  years) was independently associated with 28 day mortality (AOR = 8.68, 95 % CI: 6.18-12.49,  $p < 0.001$ ) after adjusting for service unit.

### 16.3.9 *Caveats and Conclusions*

As was the case with linear regression, logistic regression is an extremely powerful tool for data analysis of health data. Although the study outcomes in each approach are different, the framework and way of thinking of the problem have similarities. Likewise, many of the problems encountered in linear regression are also of concern in logistic regression. Outliers, missing data, colinearity and dependent/correlated outcomes are all problems for logistic regression as well, and can be dealt with in a similar fashion. Modelling assumptions are as well, and we briefly touched on this when discussing whether it was appropriate to use age as a continuous covariate in our models. Although continuous covariates are frequently modeled in this way, it is important to ensure if the relationship between the log odds of the outcome is indeed linear with the covariate. In cases where the data has been divided into too many subgroups (or the study may be simply too small), you may encounter a level of a discrete variable where none (or very few) of one of the outcomes occurred. For example, if we had an additional `service_unit` with 50 patients, all of whom lived. In such a case, the estimated odds ratios and subsequent confidence intervals or hypothesis testing may not be appropriate to use. In such a case, collapsing the discrete covariate into fewer categories will often help return the analysis into a manageable form. For our hypothetical new service unit, creating a new group of it and FICU would be a possible solution. Sometimes a covariate is so strongly related to the outcome, and this is no longer possible, and the only solution may be to report this finding, and remove these patients.

Overall, logistic regression is a very valuable tool in modelling binary and categorical data. Although we did not cover this latter case, a similar framework is

available for discrete data which is ordered or has more than one category (see `?multinom` in the `nnet` package in R for details about multinomial logistic regression). This and other topics such as assessing model fit, and using logistic regression in more complicated study designs are discussed in [11].

## 16.4 Survival Analysis

### 16.4.1 Section Goals

In this section, the reader will learn the fundamentals of survival analysis, and how to present and interpret such an analysis.

### 16.4.2 Introduction

As you will note that in the previous section on logistic regression, we specifically looked at the mortality outcome at 28 days. This was deliberate, and illustrates a limitation of using logistic regression for this type of outcome. For example, in the previous analysis, someone who died on day 29 was treated identically as someone who went on to live for 80+ years. You may wonder, why not just simply treat the survival time as a continuous variable, and perform linear regression analysis on this outcome? There are several reasons, but the primary reason is that you likely won't be able to wait around for the lifetime for each study participant. It is likely in your study only a fraction of your subjects will die before you're ready to publish your results.

While we often focus on mortality this can occur for many other outcomes, including times to patient relapse, re-hospitalization, reinfection, etc. In each of these types of outcomes, it is presumed the patients are at risk of the outcome until the event happens, or until they are *censored*. Censoring can happen for a variety of different reasons, but indicates the event was not observed during the observation time. In this sense, survival or more generally time-to-event data is a bivariate outcome incorporating the observation or study time in which the patient was observed and whether the event happened during the period of observation. The particular case we will be most interested is *right censoring* (subjects are observed only up to a point in time, and we don't know what happens beyond this point), but there is also *left censoring* (we only know the event happened before some time point) and *interval censoring* (events happen inside some time window). Right censoring is generally the most common type, but it is important to understand how the data was collected to make sure that it is indeed right censored.

Establishing a common time origin (i.e., a place to start counting time) is often easy to identify (e.g., admission to the ICU, enrollment in a study, administration of

a drug, etc.), but in other scenarios it may not be (e.g., perhaps interest lies in survival time since disease onset, but patients are only followed from the time of disease diagnosis). For a good treatment on this topic and other issues, see Chap. 3 of [12].

With this additional complexity in the data (relative to logistic and linear regression), there are additional technical aspects and assumptions to the data analysis approaches. In general, each approach attempts to compare groups or identify covariates which modify the survival rates among the patients studied.

Overall survival analysis is a complex and fascinating area of study, and we will only touch briefly on two types of analysis here. We largely ignore the technical details of these approaches focusing on general principles and intuition instead. Before we begin doing any survival analysis, we need to load the `survival` package in R, which we can do by running:

```
library(survival);
```

Normally, you can skip the next step, but since this dataset was used to analyze the data in a slightly different way, we need to correct the observation times for a subset of the subjects in the dataset.

```
dat$mort_day_censored[dat$censor_flg==1] <- 731;
```

### 16.4.3 Kaplan-Meier Survival Curves

Now that we have the technical issues sorted out, we can begin by visualizing the data. Just as the  $2 \times 2$  table is a fundamental step in the analysis of binary data, the fundamental step for survival data is often plotting what is known as a Kaplan-Meier survival function [13]. The *survival function* is a function of time, and is the probability of surviving at least that amount of time. For example, if there was 80 % survival at one year, the survival function at one year is 0.8. Survival functions normally start at `time = 0`, where the survivor function is 1 (or 100 % – everyone is alive), and can only stay the same or decrease. If it were to increase as time progressed, that would mean people were coming back to life! Kaplan-Meier plots are one of the most widely used plots in medical research.

Before plotting the Kaplan-Meier plot, we need to setup a `survfit` object. This object has a familiar form, but differs slightly from the previous methodologies we covered. Specifying a formula for survival outcomes is somewhat more complicated, since as we noted, survival data has two components. We do this by creating a `Surv` object in R. This will be our survival outcome for subsequent analysis.

```
datSurv <- Surv(dat$mort_day_censored,dat$cancel_flg==0)
datSurv[101:105]

## [1] 236.08 731.00+ 731.00+ 731.00+ 2.00
```

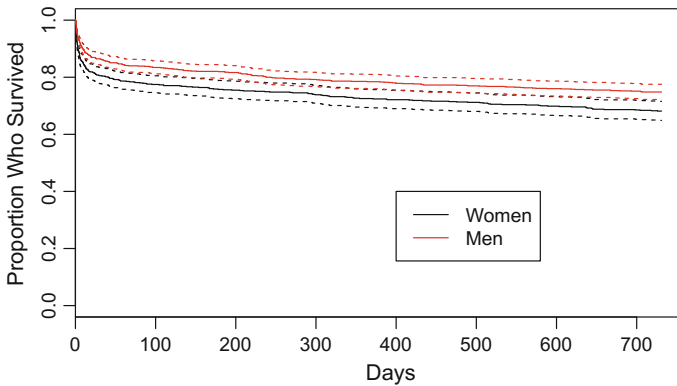
The first step setups a new kind of R object useful for survival data. The `Surv` function normally takes two arguments: a vector of times, and some kind of indicator for which patients had an event (death in our case). In our case, the vector of death and censoring times are the `mort_day_censored`, and deaths are coded with a zero in the `cancel_flg` variable (hence we identify the events where `cancel_flg == 0`). The last step prints out 5 entries of the new object (observations 101 to 105). We can see there are three entries of `731.00+`. The `+` indicates that this observation is censored. The other entries are not censored, indicating deaths at those times.

Fitting a Kaplan-Meier curve is quite easy after doing this, but requires two steps. The first specifies a formula similar to how we accomplished this for linear and logistic regression, but now using the `survfit` function. We want to ‘fit’ by gender (`gender_num`), so the formula is, `datSurv ~ gender_num`. We can then `plot` the newly created object, but we pass some additional arguments to the plot function which include 95 % confidence intervals for the survival functions (`conf.int = TRUE`), and includes a x- and y- axis label (`xlab` and `ylab`). Lastly we add a legend, coding black for the women and red for the men. This plot is in Fig. 16.6.

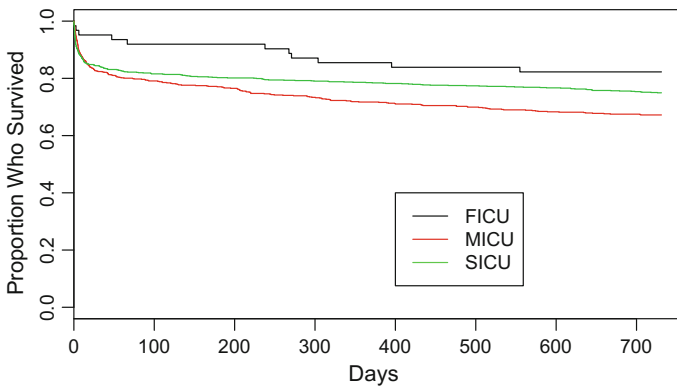
```
gender.surv <- survfit(datSurv~gender_num,data=dat)
plot(gender.surv,col=1:2,conf.int = TRUE,xlab="Days",ylab="Proportion Who Survived")
legend(400,0.4,col=c("black","red"),lty=1,c("Women","Men"))
```

In Fig. 16.6, there appears to be a difference between the survival function between the two gender groups, with again the male group (red) dying at slightly slower rate than the female group (black). We have included 95 % point-wise confidence bands for the survival function estimate, which assesses how much certain we are about the estimated survivorship at each point in time. We can do the same for `service_unit`, but since it has three groups, we need to change the color argument and legend to ensure the plot is properly labelled. This plot is in Fig. 16.7.

```
unit.surv <- survfit(datSurv~service_unit,data=dat)
plot(unit.surv,col=1:3,conf.int = FALSE,xlab="Days",ylab="Proportion Who Survived")
legend(400,0.4,col=c("black","red","green"),lty=1,c("PICU","MICU","SICU"))
```



**Fig. 16.6** Kaplan-Meier plot of the estimated survivor function stratified by gender



**Fig. 16.7** Kaplan-Meier plot of the estimated survivor function stratified by service unit

#### 16.4.4 Cox Proportional Hazards Models

Kaplan-Meier curves are a good first step in examining time to event data before proceeding with any more complex statistical model. Time to event outcomes are in general more complex than the other types of outcomes we have examined thus far. There are several different modelling approaches, each of which has some advantages and limitations. The most popular approach for health data is likely the Cox Proportional Hazards Model [14], which is also sometimes called the Cox model or Cox Regression. As the name implies this method models something called the hazard function. We will not dwell on the technical details, but attempt to provide some intuition. The hazard function is a function of time (hours, days, years) and is approximately the instantaneous probability of the event occurring (i.e., chance the event is happening in some very small time window) given the event has not



already happened. It is frequently used to study mortality, sometimes going by the name force of mortality or instantaneous death rate, and can be interpreted simply as the risk of death at a particular time, given that the person has survived up until that point. The “proportional” part of Cox’s model assumes that the way covariates effect the hazard function for different types of patients is through a proportionality assumption relative to the baseline hazard function. For illustration, consider a simple case where two treatments are given, for treatment 0 (e.g., the placebo) we determine the hazard function is  $h_0(t)$ , and for treatment 1 we determine the hazard function is  $h_1(t)$ , where  $t$  is time. The proportional hazards assumption is that:

$$h_1(t) = HR \times h_0(t).$$

It’s easy to see that  $HR = h_1(t)/h_0(t)$ . This quantity is often called the hazard ratio, and if for example it is two, this would mean that the risk of death in the treatment 1 group was twice as high as the risk of death in the treatment zero group. We will note, that  $HR$  is *not* a function of time, meaning that the risk of death is *always* twice as high in the first group when compared to the second group. This assumption means that if the proportional hazards assumption is valid we need only know the hazard function from group 0, and the hazard ratio to know the hazard function for group 1. Estimation of the hazard function under this model is often considered a nuisance, as the primary focus is on the hazard ratio, and this is key to being able to fit and interpret these models. For a more technical treatment of this topic, we refer you to [12, 15–17].

As was the case with logistic regression, we will model the log of the hazard ratio instead of the hazard ratio itself. This allows us to use the familiar framework we have used thus far for modeling other types of health data. Like logistic regression, when the  $\log(HR)$  is zero, the  $HR$  is one, meaning the risk between the groups is the same. Furthermore, this extends to multiple covariate models or continuous covariates in the same manner as logistic regression.

Fitting Cox regression models in R will follow the familiar pattern we have seen in the previous cases of linear and logistic regressions. The `coxph` function (from the `survival` package) is the fitting function for Cox models, and it continues the general pattern of passing a model formula (`outcome ~ covariate`), and the dataset you would like to use. In our case, let’s continue our example of using gender (`gender_num`) to model the `datSurv` outcome we created, and running the `summary` function to see what information is outputted.

```

gender.coxph <- coxph(datSurv ~ gender_num,data=dat)
summary(gender.coxph)

## Call:
## coxph(formula = datSurv ~ gender_num, data = dat)
##
## n= 1775, number of events= 497
## (1 observation deleted due to missingness)
##
##          coef exp(coef) se(coef)      z Pr(>|z|)
## gender_num -0.29094  0.74756  0.08978 -3.24  0.00119 **
## ---
## Signif. codes:  0 '***' 0.001 '**' 0.01 '*' 0.05 '.' 0.1 ' ' 1
##
##          exp(coef) exp(-coef) lower .95 upper .95
## gender_num    0.7476      1.338    0.6269    0.8914
##
## Concordance= 0.537 (se = 0.011 )
## Rsquare= 0.006 (max possible= 0.983 )
## Likelihood ratio test= 10.43 on 1 df,  p=0.001243
## Wald test              = 10.5 on 1 df,  p=0.001193
## Score (logrank) test = 10.58 on 1 df,  p=0.001146

```

The coefficients table has the familiar format, which we've seen before. The `coef` for `gender_num` is about  $-0.29$ , and this is the estimate of our log-hazard ratio. As discussed, taking the exponential of this gives the hazard ratio (HR), which the summary output computes in the next column (`exp(coef)`). Here, the HR is estimated at 0.75, indicating that men have about a 25 % reduction in the hazards of death, under the proportional hazards assumption.

The next column in the coefficient table has the standard error for the log hazard ratio, followed by the  $z$  score and  $p$ -value ( $\Pr(>|z|)$ ), which is very similar to what we saw in the case of logistic regression. Here we see the  $p$ -value is quite small, and we would reject the null hypothesis that the hazard functions are the same between men and women. This is consistent with the exploratory figures we produced using Kaplan-Meier curves in the previous section. For `coxph`, the `summary` function also conveniently outputs the confidence interval of the HR a few lines down, and here our estimate of the HR is 0.75 (95 % CI: 0.63–0.89,  $p = 0.001$ ). This is how the HR would typically be reported.

Using more than one covariate works the same as our other analysis techniques. Adding a co-morbidity to the model such as atrial fibrillation (`afib_flg`) can be done as you would do for logistic regression.

```

genderafib.coxph <- coxph(datSurv~gender_num + afib_flg,data=dat)
summary(genderafib.coxph)$coef

##          coef exp(coef) se(coef)      z Pr(>|z|)
## gender_num -0.2591201  0.7717304  0.08987143 -2.883231  0.003936189
## afib_flg    1.3443975  3.8358747  0.10200099  13.180239  0.000000000

```

Here again male gender is associated with reduced time to death, while atrial fibrillation increases the hazard of death by almost four-fold. Both are statistically significant in the summary output, and we know from before that we can test a large number of other types of statistical hypotheses using the `anova` function. Again we pass `anova` the smaller (`gender_num` only) and larger (`gender_num` and `afib_flg`) nested models.

```
anova(gender.coxph,genderafib.coxph)

## Analysis of Deviance Table
## Cox model: response is datSurv
## Model 1: ~ gender_num
## Model 2: ~ gender_num + afib_flg
##   loglik   Chisq Df P(>|Chi|)
## 1 -3636.1
## 2 -3567.4 137.37  1 < 2.2e-16 ***
## ---
## Signif. codes:  0 '***' 0.001 '**' 0.01 '*' 0.05 '.' 0.1 ' ' 1
```

As expected, atrial fibrillation is very statistically significant, and therefore we would like to keep it in the model.

Cox regression also allows one to use covariates which change over time. This would allow one to incorporate changes in treatment, disease severity, etc. within the same patient without need for any different methodology. The major challenge to do this is mainly in the construction of the dataset, which is discussed in some of the references at the end of this chapter. Some care is required when the time dependent covariate is only measure periodically, as the method requires that it be known at every event time for the entire cohort of patients, and not just those relevant to the patient in question. This is more practical for changes in treatment which may be recorded with some precision, particularly in a database like MIMIC II, and less so for laboratory results which may be measured at the resolution of hours, days or weeks. Interpolating between lab values or carrying the last observation forward has been shown to introduce several types of problems.

### 16.4.5 Caveats and Conclusions

We will conclude this brief overview of survival analysis, but acknowledge we have only scratched the surface. There are many topics we have not covered or we have only briefly touched on.

Survival analysis is distinguished from other forms of analyses covered in this Chapter, as it allows the data to be censored. As was the case for the other approaches we considered, there are modeling assumptions. For instance, it is important that the censoring is not informative of the survival time. For example, if censoring occurs when treatment is withdrawn *because* the patient is too sick to

continue therapy, this would be an example of informative censoring. The validity of all methods discussed in this section are then invalid. Care should be taken to make sure you understand the censoring mechanism as to avoid any false inferences drawn.

Assessment of the proportional hazards assumption is an important part of any Cox regression analysis. We refer you to the references (particularly [17] and see `?cox.zph`) at the end of this chapter for strategies and alternatives for when the proportional hazards assumption breaks down. In some circumstances, the proportional hazards assumption is not valid, and alternative approaches can be used. As is always the case, when outcomes are dependent (e.g., one patient may contribute more than one observation), the methods discussed in this section should not be used directly. Generally the standard error estimates will be too small, and  $p$ -values will be incorrect. The concerns in logistic regression regarding outliers, co-linearity, missing data, and covariates with sparse outcomes apply here as well, as do the concerns about model misspecification for continuous covariates.

Survival analysis is a powerful analysis technique which is extremely relevant for health studies. We have only given a brief overview of the subject, and would encourage you to further explore these methods.

## 16.5 Case Study and Summary

### 16.5.1 Section Goals

In this section, we will work through a case study, and discuss the data analysis components which should be included in an original research article suitable for a clinical journal. We will also discuss some approaches for model and feature selection.

### 16.5.2 Introduction

We will now use what we learned in the previous sections to examine if indwelling arterial catheters (IAC) have any effect on patient mortality. As reiterated throughout, clearly identifying a study objective is important for a smooth data analysis. In our case, we'd like to estimate the effect of IAC on mortality, but acknowledge a few potential problem areas. First, the groups who receive IAC and those who don't are likely different in many respects, and many of these differences likely also have some effect on mortality. Second, we would like to be able to limit ourselves on mortality events which occur in close proximity to the ICU admission. The dataset includes 28 day mortality, so that would seem to be in close proximity to the ICU admission. As for the first issue, we also have many

covariates which capture some of the features we may be concerned with, including severity of illness (`sapsi_first` and `sofa_first`), age (`age`), patient gender (`gender_num`) and co-morbidities (`chf_flg`, `afib_flg`, `renal_flg`, etc.).

With all these in mind, we should have a good start on determining our study objective. In our case, it might be,

To estimate the effect that administration of IAC during an ICU admission has on 28 day mortality in patients within the MIMIC II study who received mechanical ventilation, while adjusting for age, gender, severity of illness and comorbidities.

For now, this describes our outcome and covariates quite well. One of the first things that is often done is to describe our population by computing summary statistics of all or a subset of variables collected in the study. This description allows the reader to understand how well the study would generalize to other populations. We have made available an R package on GitHub that will allow one to construct preliminary forms of such a table quite quickly. To install the R package, first install and load the `devtools` package:

```
install.packages("devtools")
library(devtools)
```

and then install and load our package by using the `install_github` function.

```
install_github("jraffa/MIMICbook")
library(MIMICbook);
```

Before we do any in depth analysis, let's make sure we are using the original dataset, first by removing and then reloading the `dat` data frame. In order to ensure our research is reproducible, it's a good idea to make sure the entire process of doing the analysis is documented. By starting from the original copy of the dataset, we are able to present precisely what methods we used in an analysis.

```
rm(dat)
dat <- read.csv(url)
```

As mentioned before, recoding binary encoded variables (ones which are 0s and 1s) to the R data class `factor` can sometimes make interpreting the R output easier. The following piece of code cycles through all the columns in `dat` and converts any binary variables to a `factor`.

```

# Identify which columns are binary coded
bincols <- colMeans((dat == 1 | dat == 0), na.rm = T) == 1
for (i in 1:length(bincols)) {
  # Turn the binary columns into a factor
  if (bincols[i]) {
    dat[[i]] <- as.factor(dat[[i]])
  }
}

```

We are now ready to generate a summary of the patient characteristics in our study. The `MIMICbook` package has a `produce.table1` function. This generates a summary table of the data frame you pass to it, using an appropriate summary for continuous variables (average and standard deviation) and categorical variables (number and percentages) for each variable. In its most simple form, `produce.table1` can be passed a data frame as an argument, which we do (passing it the `dat` data frame). This output is not very nice, and we can make it look nicer by using a powerful R package called `knitr`, which provides many tools to assist in performing reproducible research. You can find out more about `knitr` (which can be installed using `install.packages("knitr")`), by running `?knitr` on the R console after loading it. We will be using the `kable` command, which will take our `tab1` variable—a summary table we generated using the `produce.table1` function, and make it look a little nicer.

```

tab1 <- produce.table1(dat);
library(knitr);
kable(tab1, caption = "Overall patient characteristics")

```

The row descriptors are not very informative, and what we have produced would not be usable for final publication, but it suits our purposes for now. `knitr` allows one to output such tables in HTML, LaTeX or even a Word document, which you can edit and make the table more informative. The results are contained in [Table 16.1](#).

A couple things we may notice from the baseline characteristics are:

1. Some variables have a lot of missing observations (e.g., `bmi`, `po2_first`, `iv_day_1`).
2. None of the patients have sepsis.

Both of these points are important, and illustrates why it is always a good idea to perform basic descriptive analyses before beginning any modeling. The missing data is primarily related to weight/BMI, or lab values. For the purpose of this chapter, we are going to ignore both of these classes of variables. While we would likely want to adjust for some of these covariates in a final version of the paper, and [Chap. 11](#) gives some useful techniques for dealing with such a situation, we are going to focus on the set of covariates we had identified in our study objective, which do not include these variables. The issue related to sepsis is also of note.

**Table 16.1** Overall patient characteristics

	Average (SD), or N (%)
aline_flg==1	984 (55.4 %)
icu_los_day	3.3 (3.4)
hospital_los_day	8.1 (8.2)
age	54.4 (21.1)
gender_num==1	1025 (57.7 %) [Missing: 1]
weight_first	80.1 (22.5) [Missing: 110]
bmi	27.8 (8.2) [Missing: 466]
sapsi_first	14.1 (4.1) [Missing: 85]
sofa_first	5.8 (2.3) [Missing: 6]
service_unit==SICU	982 (55.3 %)
service_num==1	982 (55.3 %)
day_icu_intime==Saturday	278 (15.7 %)
day_icu_intime_num	4.1 (2)
hour_icu_intime	10.6 (7.9)
hosp_exp_flg==0	1532 (86.3 %)
icu_exp_flg==0	1606 (90.4 %)
day_28_flg ==0	1493 (84.1 %)
mort_day_censored	614.3 (403.1)
cancel_flg==1	1279 (72 %)
sepsis_flg==0	1776 (100 %)
chf_flg==0	1563 (88 %)
afib_flg==0	1569 (88.3 %)
renal_flg==0	1716 (96.6 %)
liver_flg==0	1677 (94.4 %)
copd_flg==0	1619 (91.2 %)
cad_flg==0	1653 (93.1 %)
stroke_flg==0	1554 (87.5 %)
mal_flg==0	1520 (85.6 %)
resp_flg==0	1211 (68.2 %)
map_1st	88.2 (17.6)
hr_1st	87.9 (18.8)
temp_1st	97.8 (4.5) [Missing: 3]
spo2_1st	98.4 (5.5)
abg_count	6 (8.7)
wbc_first	12.3 (6.6) [Missing: 8]
hgb_first	12.6 (2.2) [Missing: 8]
platelet_first	246.1 (99.9) [Missing: 8]
sodium_first	139.6 (4.7) [Missing: 5]
potassium_first	4.1 (0.8) [Missing: 5]
tco2_first	24.4 (5) [Missing: 5]
chloride_first	103.8 (5.7) [Missing: 5]

(continued)

**Table 16.1** (continued)

	Average (SD), or N (%)
<code>aline_flg==1</code>	984 (55.4 %)
<code>bun_first</code>	19.3 (14.4) [Missing: 5]
<code>creatinine_first</code>	1.1 (1.1) [Missing: 6]
<code>po2_first</code>	227.6 (144.9) [Missing: 186]
<code>pco2_first</code>	43.4 (14) [Missing: 186]
<code>iv_day_1</code>	1622.9 (1677.1) [Missing: 143]

Sepsis certainly would contribute to higher rates of mortality when compared to patients without sepsis, but since we do not have any patients with sepsis, we cannot and do not need to adjust for this covariate per se. What we do need to do is acknowledge this fact by revising our study objective. We originally identified our population as patients within MIMIC, but because this is a subset of MIMIC—those without sepsis, we should revise the study objective to:

To estimate the effect that administration of IAC during an ICU admission has on 28 day mortality in patients without sepsis who received mechanical ventilation within MIMIC II, while adjusting for age, gender, severity of illness and comorbidities.

We will also *not* want to include the `sepsis_flg` variable as a covariate in any of our models, as there are no patients with sepsis within this study to estimate the effect of sepsis. Now that we have examined the basic overall characteristics of the patients, we can begin the next steps in the analysis.

The next steps will vary slightly, but it is often useful to put yourself in the shoes of a peer reviewer. What problems will a reviewer likely find with your study and how can you address them? Usually, the reviewer will want to see how the population differs for different values of the covariate of interest. In our case study, if the treated group (IAC) differed substantially from the untreated group (no IAC), then this may account for any effect we demonstrate. We can do this by summarizing the two groups in a similar fashion as was done for Table 16.1. We can reuse the `produce.table1` function, but we pass it the two groups separately by splitting the `dat` data frame into two using the `split` function (by the `aline_flg` variable), later combining them into one table using `cbind` to yield Table 16.2. It's important to ensure that the same reference groups are used across the two study groups, and that's what the `labels` argument is used for (see `?produce.table1` for more details).

```
datby.aline <- split(dat, dat$aline_flg)
reftable <- produce.table1(datby.aline[[1]])
tab2 <- cbind(produce.table1(datby.aline[[1]], labels = attr(reftable, "labels")),
             produce.table1(datby.aline[[2]], labels = attr(reftable, "labels")))
colnames(tab2) <- paste0("Average (SD), or N (%)", c("No-IAC", "IAC"))
kable(tab2, caption = "Patient characteristics stratified by IAC administration")
```



**Table 16.2** Patient characteristics stratified by IAC administration

	Average (SD), or N (%), No-IAC	Average (SD), or N (%), IAC
aline_flg==0	792 (100 %)	0 (0 %)
icu_los_day	2.1 (1.9)	4.3 (3.9)
hospital_los_day	5.4 (5.4)	10.3 (9.3)
age	53 (21.7)	55.5 (20.5)
gender_num==1	447 (56.5 %) [Missing: 1]	578 (58.7 %)
weight_first	79.2 (22.6) [Missing: 71]	80.7 (22.4) [Missing: 39]
bmi	28 (9.1) [Missing: 220]	27.7 (7.5) [Missing: 246]
sapsi_first	12.7 (3.8) [Missing: 70]	15.2 (4) [Missing: 15]
sofa_first	4.8 (2.1) [Missing: 4]	6.6 (2.2) [Missing: 2]
service_unit==MICU	480 (60.6 %)	252 (25.6 %)
service_num==0	504 (63.6 %)	290 (29.5 %)
day_icu_intime==Saturday	138 (17.4 %)	140 (14.2 %)
day_icu_intime_num	4 (2)	4.1 (2)
hour_icu_intime	9.9 (7.7)	11 .2 (8. 1)
hosp_exp_flg==0	702 (88.6 %)	830 (84.3 %)
icu_exp_flg==0	734 (92.7 %)	872 (88.6 %)
day_28_flg==0	679 (85.7 %)	814 (82.7 %)
mort_day_censored	619.1 (388.3)	610.5 (414.8)
sensor_flg==1	579 (73.1 %)	700 (71.1 %)
sepsis_flg==0	792 (100 %)	984 (100 %)
chf_flg==0	695 (87.8 %)	868 (88.2 %)
afib_flg==0	710 (89.6 %)	859 (87.3 %)
renal_flg==0	764 (96.5 %)	952 (96.7 %)
liver_flg==0	754 (95.2 %)	923 (93.8 %)
copd_flg==0	711 (89.8 %)	908 (92.3 %)
cad_flg==0	741 (93.6 %)	912 (92.7 %)
stroke_flg==0	722 (91.2 %)	832 (84.6 %)
mal_flg=0	700 (88.4 %)	820 (83.3 %)
resp_flg==0	514 (64.9 %)	697 (70.8 %)
map_1st	87.5 (15.9)	88.9 (18.8)
hr_st	88.4 (18.8)	87.5 (18.7)
temp_1st	97.9 (3.8) [Missing: 3]	97.7 (5.1)
spo2_1st	98.4 (5.7)	98.5 (5.4)
abg_count	1.4 (1.6)	9.7 (10.2)
wbc_first	11.7 (6.5) [Missing: 6]	12.8 (6.6) [Missing: 2]
hgb_first	12.7 (2.2) [Missing: 6]	12.4 (2.2) [Missing: 2]
platelet_first	254.3 (104.5) [Missing: 6]	239.5 (95.6) [Missing: 2]
sodium_first	139.8 (4.8) [Missing: 3]	139.4 (4.7) [Missing: 2]
potassium_first	4.1 (0.8) [Missing: 3]	4.1 (0.8) [Missing: 2]

(continued)

**Table 16.2** (continued)

	Average (SD), or N (%), No-IAC	Average (SD), or N (%), IAC
tco2_first	24.7 (4.9) [Missing: 3]	24.2 (5.1) [Missing: 2]
chloride_first	103.3 (5.4) [Missing: 3]	104.3 (5.9) [Missing: 2]
bun_first	18.9 (14.5) [Missing: 3]	19.6 (14.3) [Missing: 2]
creatinine_first	1.1 (1.2) [Missing: 4]	1.1 (1) [Missing: 2]
po2_first	223.8 (152.9) [Missing: 178]	230.1 (139.6) [Missing: 8]
pco2_first	44.9 (15.9) [Missing: 178]	42.5 (12.5) [Missing: 8]
iv_day_1	[1364.2 (1406.8) Missing: 110]	1808.4 (1825) [Missing: 33]

As you can see in Table 16.2, the IAC group differs in many respects to the non-IAC group. Patients who were given IAC tended to have higher severity of illness at baseline (`sapsi_first` and `sofa_first`), slightly older, less likely to be from the MICU, and have slightly different co-morbidity profiles when compared to the non-IAC group.

Next, we can see how the covariates are distributed among the different outcomes (death within 28 days versus alive at 28 days). This will give us an idea of which covariates may be important for affecting the outcome. The code to generate this is nearly identical to that used to produce Table 16.2, but instead, we replace `aline_flg` with `day_28_flg` (the outcome) to get Table 16.3.

```
datby.28daymort <- split(dat, dat$day_28_flg)
reftablemort <- produce.table1(datby.28daymort[[1]])
tab3 <- cbind(produce.table1(datby.28daymort[[1]], labels = attr(reftablemort,
  "labels")), produce.table1(datby.28daymort[[2]], labels = attr(reftablemort,
  "labels")))
colnames(tab3) <- paste0("Average (SD), or N (%)", c("Alive", "Dead"))
kable(tab3, caption = "Patient characteristics stratified by 28 day mortality")
```

As can be seen in Table 16.3, those patients who died within 28 days differ in many ways with those who did not. Those who died had higher SAPS and SOFA scores, were on average older, and had different co-morbidity profiles.

### 16.5.3 Logistic Regression Analysis

In Table 16.3, we see that of the 984 subjects receiving IAC, 170 (17.2 %) died within 28 days, whereas 113 of 792 (14.2 %) died in the no-IAC group. In a univariate analysis we can assess if the lower rate of mortality is statistically significant, by fitting a single covariate `aline_flg` logistic regression.

**Table 16.3** Patient characteristics stratified by 28 day mortality

	Average (SD), or N (%), alive	Average (SD), or N (%), dead
aline_flg==1	814 (54.5 %)	170 (60.1 %)
icu_los_day	3.2 (3.2)	4 (4)
hospital_los_day	8.4 (8.4)	6.4 (6.4)
age	50.8 (20.1)	73.3 (15.3)
gender_num==1	886 (59.4 %) [Missing: 1]	139 (49.1 %)
weight_first	81.4 (22.7) [Missing: 77]	72.4 (19.9) [Missing: 33]
bmi	28.2 (8.3) [Missing: 392]	26 (7.2) [Missing: 74]
sapsi_first	13.6 (3.9) [Missing: 51]	17.3 (3.8) [Missing: 34]
sofa_first	5.7 (2.3) [Missing: 3]	6.6 (2.4) [Missing: 3]
service_unit==SICU	829 (55.5 %)	153 (54.1 %)
service_num==1	829 (55.5 %)	153 (54.1 %)
day_icu_intime==Saturday	235 (15.7 %)	43 (15.2 %)
day_icu_intime_num	4 (2)	4.1 (2)
hour_icu_intime	10.5 (7.9)	11 (8)
hosp_exp_flg==0	1490 (99.8 %)	42 (14.8 %)
icu_exp_flg==0	1493 (100 %)	113 (39.9 %)
day_28_flg==0	1493 (100 %)	0 (0 %)
mort_day_censored	729.6 (331.4)	6.1 (6.4)
cancel_flg==1	1279 (85.7 %)	0 (0 %)
sepsis_flg==0	1493 (100 %)	283 (100 %)
chf_flg==0	1348 (90.3 %)	215 (76 %)
afib_flg==0	1372 (91.9 %)	197 (69.6 %)
renal_flg==0	1447 (96.9 %)	269 (95.1 %)
liver_flg==0	1413 (94.6 %)	264 (93.3 %)
copd_flg==0	1377 (92.2 %)	242 (85.5 %)
cad_flg==0	1403 (94 %)	250 (88.3 %)
stroke_flg==0	1386 (92.8 %)	168 (59.4 %)
mal_flg==0	1294 (86.7 %)	226 (79.9 %)
resp_flg==0	1056 (70.7 %)	155 (54.8 %)
map_1st	88.2 (17.5)	88.3 (17.9)
hr_1st	88.3 (18.4)	85.8 (20.6)
temp_1st	97.8 (4.6) [Missing: 1]	97.7 (4.5) [Missing: 2]
spo2_1st	98.6 (5)	97.8 (7.6)
abg_count	5.7 (7.7)	7.5 (12.5)
wbc_first	12.2 (6.4) [Missing: 6]	12.7 (7.5) [Missing: 2]
hgb_first	12.7 (2.2) [Missing: 6]	11.9 (2.1) [Missing: 2]

(continued)

**Table 16.3** (continued)

	Average (SD), or N (%), alive	Average (SD), or N (%), dead
platelet_first	246.8 (97.3) [Missing: 6]	242.1 (112.6) [Missing: 2]
sodium_first	139.6 (4.6) [Missing: 4]	139.1 (5.4) [Missing: 1]
potassium_first	4.1 (0.8) [Missing: 4]	4.2 (0.9) [Missing: 1]
tco2_first	24.3 (4.8) [Missing: 4]	25 (5.8) [Missing: 1]
chloride_first	104.1 (5.6) [Missing: 4]	102.6 (6.4) [Missing: 1]
bun_first	18 (12.9) [Missing: 4]	26.2 (19) [Missing: 1]
creatinine_first	1.1 (1.1) [Missing: 5]	1.2 (0.9) [Missing: 1]
po2_first	231.3 (146.3) [Missing: 153]	207.9 (135.8) [Missing: 33]
pco2_first	43.3 (12.9) [Missing: 153]	43.8 (18.6) [Missing: 33]
iv_day_1	1694.2 (1709.5) [Missing: 127]	1258 (1449.4) [Missing: 16]

```
uvr.glm <- glm(day_28_flg ~ aline_flg,data=dat,family="binomial")
exp(uvr.glm$coef[-1])
```

```
## aline_flg1
## 1.254919
```

```
exp(confint(uvr.glm)[-1,]);
```

```
## 2.5 % 97.5 %
## 0.9701035 1.6285165
```

Those who received IAC had over a 25 % increase in odds of 28 day mortality when compared to those who did not receive IAC. The confidence interval includes one, so we would expect the  $p$ -value would be  $>0.05$ . Running the summary function, we see that this is the case.

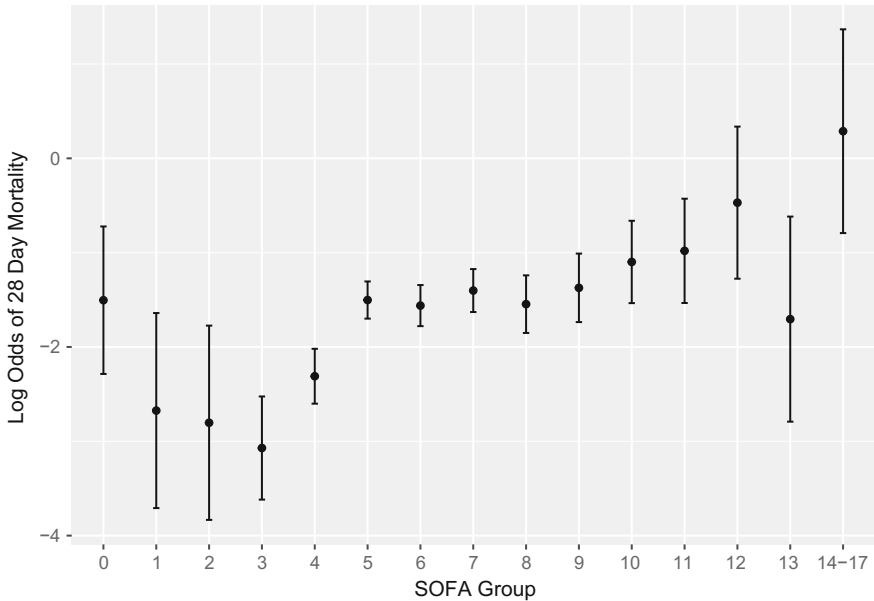
```
##           Estimate Std. Error   z value    Pr(>|z|)
## (Intercept) -1.7932333  0.1015988 -17.650149 1.014880e-69
## aline_flg1  0.2270714  0.1320347  1.719786 8.547142e-02
```

Indeed, the  $p$ -value for `aline_flg` is about 0.09. As we saw in Table 16.2, there are likely several important covariates that differed among those who received IAC and those who did not. These may serve as confounders, and the possible association we observed in the univariate analysis may be stronger, non-existent or in the opposite direction (i.e., IAC having lower rates of mortality) depending on the situation. Our next step would be to adjust for these confounders. This is an

exercise in what is known as model building, and there are several ways people do this in the literature. A common approach is to fit all univariate models (one covariate at a time, as we did with `aline_flg`, but separately for each covariate and without `aline_flg`), and perform a hypothesis test on each model. Any variables which had statistical significance under the univariate models would then be included in a multivariable model. Another approach begins with the model we just fit (`uvr.glm` which only has `aline_flg` as a covariate), and then sequentially adds variables one at a time. This approach is often called *step-wise forward selection*. We will make a choice to do *step-wise backwards selection*, which is as it sounds—the opposite direction of step-wise forward selection. Model selection is a challenging task in data analysis, and there are many other methods [18] we couldn't possibly describe in full detail here. As an overall philosophy, it is important to outline and describe the process by which you will do model selection before you actually do it and stick with the process.

In our stepwise backwards elimination procedure, we are going to fit a model containing IAC (`aline_flg`), age (`age`), gender, (`gender_num`), disease severity (`sapsi_first` and `sofa_first`), service type (`service_unit`), and comorbidities (`chf_flg`, `afib_flg`, `renal_flg`, `liver_flg`, `copd_flg`, `cad_flg`, `stroke_flg`, `mal_flg` and `resp_flg`). This is often called the *full model*, and is fit below (`mva.full.glm`). From the full model, we will proceed by eliminating one variable at a time, until we are left with a model with only statistically significant covariates. Because `aline_flg` is the covariate of interest, it will remain in the model regardless of its statistical significance. At each step we need to come up with a criteria to choose which variable we will eliminate. There are several ways of doing this, but one way we can make this decision is performing a hypothesis test for each covariate, and choosing to eliminate the covariate with the largest  $p$ -value, unless all  $p$ -values are  $<0.05$  or the largest  $p$ -value is `aline_flg`, in which case we would stop or eliminate the next largest  $p$ -value, respectively.

Most of the covariates are binary or categorical in nature, and we've already converted them to factors. The disease severity scores (SAPS and SOFA) are continuous. We could add them as we did age, but this assumes a linear trend in the odds of death as these scores change. This may or may not be appropriate (see Fig. 16.8). Indeed, when we plot the log odds of 28 day death by SOFA score, we note that while the log odds of death generally increase as the SOFA score increases the relationship may not be linear (Fig. 16.8).



**Fig. 16.8** Plot of log-odds of mortality for each of the SOFA groups. *Error bars* represent 95 % confidence intervals for the log odds

What can be done in this situation is to turn a continuous covariate into a discrete one. A quick way of doing this is using the `cut2` function in the `Hmisc` package.<sup>2</sup> Applying `cut2(sofa_first, g = 5)` turns the `sofa_first` variable into five approximately equal sized groups by SOFA score. For illustration, SOFA breaks down into the following sized groups by SOFA scores:

```
library(Hmisc)
table(cut2(dat$sofa_first, g=5))

##
## [0, 5)      5      6 [7, 9) [9,17]
##      523    346    294    391    216
```

with not quite equal groups, due to the already discretized nature of SOFA to begin with. We will treat both SAPS and SOFA in this way in order to avoid any model misspecification that may occur as a result of assuming a linear relationship.

Returning to fitting the full model, we use these new disease severity scores, along with the other covariates we identified to include in the full model.

<sup>2</sup>You may need to install `Hmisc`, which can be done by running `install.packages('Hmisc')` from the R command prompt.

```
mva.full.glm <- glm(day_28_flg ~ aline_flg + age + gender_num + cut2(sapsi_first,
  g = 5) + cut2(sofa_first, g = 5) + service_unit + chf_flg + afib_flg + renal_flg +
  liver_flg + copd_flg + cad_flg + stroke_flg + mal_flg + resp_flg, data = dat,
  family = "binomial")
summary(mva.full.glm)
```

```
##
## Call:
## glm(formula = day_28_flg ~ aline_flg + age + gender_num + cut2(sapsi_first,
##   g = 5) + cut2(sofa_first, g = 5) + service_unit + chf_flg +
##   afib_flg + renal_flg + liver_flg + copd_flg + cad_flg + stroke_flg +
##   mal_flg + resp_flg, family = "binomial", data = dat)
##
## Deviance Residuals:
##   Min       1Q   Median       3Q      Max
## -2.2912  -0.4710  -0.2330  -0.1104   2.9640
##
## Coefficients:
##              Estimate Std. Error z value Pr(>|z|)
## (Intercept)    -7.61471    0.86262  -8.827 < 2e-16 ***
## aline_flg1      0.01085    0.20443   0.053 0.957679
## age             0.04020    0.00627   6.412 1.44e-10 ***
## gender_num1    0.16214    0.17296   0.937 0.348527
## cut2(sapsi_first, g = 5)[12,14) 0.36961    0.40348   0.916 0.359637
## cut2(sapsi_first, g = 5)[14,16) 1.01794    0.36214   2.811 0.004940 **
## cut2(sapsi_first, g = 5)[16,19) 0.92803    0.36794   2.522 0.011662 *
## cut2(sapsi_first, g = 5)[19,32] 1.77615    0.37446   4.743 2.10e-06 ***
## cut2(sofa_first, g = 5)5         0.49761    0.30267   1.644 0.100159
## cut2(sofa_first, g = 5)6         0.58530    0.30300   1.932 0.053396 .
## cut2(sofa_first, g = 5)[7, 9)   0.68011    0.29439   2.310 0.020876 *
## cut2(sofa_first, g = 5)[9,17]   0.75134    0.34062   2.206 0.027397 *
## service_unitMICU                 1.08086    0.67839   1.593 0.111100
## service_unitSICU                 0.64257    0.67144   0.957 0.338562
## chf_flg1                          0.23350    0.23381   0.999 0.317962
## afib_flg1                         0.52408    0.21122   2.481 0.013092 *
## renal_flg1                       -0.76796    0.40904  -1.877 0.060452 .
## liver_flg1                        0.47238    0.34032   1.388 0.165125
## copd_flg1                         0.23440    0.24631   0.952 0.341287
## cad_flg1                          -0.25674    0.28823  -0.891 0.373065
## stroke_flg1                       2.04301    0.21966   9.301 < 2e-16 ***
## mal_flg1                          0.49319    0.20897   2.360 0.018274 *
## resp_flg1                         0.69330    0.19166   3.617 0.000298 ***
## ---
## Signif. codes:  0 '***' 0.001 '**' 0.01 '*' 0.05 '.' 0.1 ' ' 1
##
## (Dispersion parameter for binomial family taken to be 1)
##
##   Null deviance: 1400.58  on 1683  degrees of freedom
## Residual deviance: 954.39  on 1661  degrees of freedom
## (92 observations deleted due to missingness)
## AIC: 1000.4
##
## Number of Fisher Scoring iterations: 6
```

The summary output show that some of the covariates are very statistically significant, while others may be expendable. Ideally, we would like as simple of a model as possible that can explain as much of the variation in the outcome as

possible. We will attempt to remove our first covariate by the procedure we outlined above. For each of the variables we consider removing, we could fit a logistic regression model without that covariate, and then test it against the current model. R has a useful function that automates this process for us, called `drop1`. We pass to `drop1` our logistic regression object (`mva.full.glm`) and the type of test you would like to do. If you recall from the logistic regression section, we used `test = "Chisq"`, and this is what we will pass the `drop1` function as well.

```
drop1(mva.full.glm,test="Chisq")

## Single term deletions
##
## Model:
## day_28_flg ~ aline_flg + age + gender_num + cut2(sapsi_first,
##   g = 5) + cut2(sofa_first, g = 5) + service_unit + chf_flg +
##   afib_flg + renal_flg + liver_flg + copd_flg + cad_flg + stroke_flg +
##   mal_flg + resp_flg
##
##           Df Deviance      AIC      LRT Pr(>Chi)
## <none>
##           954.39 1000.39
## aline_flg      1   954.39  998.39  0.003 0.9576771
## age            1 1000.60 1044.60 46.210 1.063e-11 ***
## gender_num     1   955.27  999.27  0.883 0.3475044
## cut2(sapsi_first, g = 5) 4   989.69 1027.69 35.304 4.023e-07 ***
## cut2(sofa_first, g = 5) 4   960.95  998.95  6.558 0.1611514
## service_unit   2   960.11 1002.11  5.716 0.0573820 .
## chf_flg        1   955.38  999.38  0.990 0.3196816
## afib_flg       1   960.47 1004.47  6.080 0.0136708 *
## renal_flg      1   958.20 1002.20  3.814 0.0508182 .
## liver_flg      1   956.23 1000.23  1.839 0.1750410
## copd_flg       1   955.28  999.28  0.893 0.3445691
## cad_flg        1   955.20  999.20  0.811 0.3678829
## stroke_flg     1 1045.22 1089.22 90.831 < 2.2e-16 ***
## mal_flg        1   959.80 1003.80  5.410 0.0200201 *
## resp_flg       1   967.57 1011.57 13.177 0.0002834 ***
## ---
## Signif. codes:  0 '***' 0.001 '**' 0.01 '*' 0.05 '.' 0.1 ' ' 1
```

As you see from the output, each covariate is listed, along with a  $p$ -value ( $\text{Pr}(> \text{Chi})$ ). Each row represents a hypothesis test with the bigger (alternative model) being the full model (`mva.full.glm`), and each null being the full model without the row's covariate. The  $p$ -values here should match those output if you were to do this exact test with `anova`. As we can see from the listed  $p$ -values, `aline_flg` has the largest  $p$ -value, but we stipulated in our model selection plan that we would retain this covariate as it's our covariate of interest. We will then go to the next largest  $p$ -value which is the `cad_flg` variable (coronary artery disease). We will update our model, and repeat the backwards elimination step on the updated model. We could just cut and paste the `mva.full.glm` command and remove `+ cad_flg`, but an easier way less prone to errors is to use the `update`



command. The `update` function can take a `glm` or `lm` object, and alter one of the covariates. To do a backwards elimination, the second argument is `~. - variable`. The `~.` part indicates keep the outcome and the rest of the variables the same, and the `- variable` indicates to fit the model without the variable called `variable`. Hence, to fit a new model from the full model, but without the `cad_flg` variable, we would run:

```
mva.tmp.glm <- update(mva.full.glm, ~/. - cad_flg)
```

We then repeat the `drop1` step:

```
drop1(mva.tmp.glm, test="Chisq")
```

```
## Single term deletions
##
## Model:
## day_28_flg ~ aline_flg + age + gender_num + cut2(sapsi_first,
##   g = 5) + cut2(sofa_first, g = 5) + service_unit + chf_flg +
##   afib_flg + renal_flg + liver_flg + copd_flg + stroke_flg +
##   mal_flg + resp_flg
##
##           Df Deviance      AIC      LRT  Pr(>Chi)
## <none>          955.20  999.20
## aline_flg       1   955.20  997.20  0.002 0.9674503
## age             1 1000.92 1042.92 45.715 1.368e-11 ***
## gender_num      1   955.98  997.98  0.784 0.3760520
## cut2(sapsi_first, g = 5) 4   990.38 1026.38 35.180 4.266e-07 ***
## cut2(sofa_first, g = 5) 4   961.75  997.75  6.552 0.1615399
## service_unit    2   960.98 1000.98  5.782 0.0555160 .
## chf_flg         1   955.92  997.92  0.719 0.3965762
## afib_flg        1   961.32 1003.32  6.115 0.0134006 *
## renal_flg       1   959.97 1001.97  4.774 0.0288966 *
## liver_flg       1   957.06  999.06  1.862 0.1723427
## copd_flg        1   956.02  998.02  0.824 0.3640764
## stroke_flg      1 1045.73 1087.73 90.526 < 2.2e-16 ***
## mal_flg         1   960.64 1002.64  5.435 0.0197326 *
## resp_flg        1   968.84 1010.84 13.638 0.0002217 ***
## ---
## Signif. codes:  0 '***' 0.001 '**' 0.01 '*' 0.05 '.' 0.1 ' ' 1
```

and see that `aline_flg` still has the largest  $p$ -value, but `chf_flg` has the second largest, so we'll choose to remove it next. To update the new model, and run another elimination step, we would run:

```

mva.tmp.glm2 <- update(mva.tmp.glm, ~. - chf_flg)
drop1(mva.tmp.glm2,test="Chisq")

## Single term deletions
##
## Model:
## day_28_flg ~ aline_flg + age + gender_num + cut2(sapsi_first,
##   g = 5) + cut2(sofa_first, g = 5) + service_unit + afib_flg +
##   renal_flg + liver_flg + copd_flg + stroke_flg + mal_flg +
##   resp_flg
##
##           Df Deviance      AIC      LRT Pr(>Chi)
## <none>           955.92  997.92
## aline_flg       1   955.93  995.93   0.016 0.9003547
## age             1 1005.90 1045.90 49.976 1.556e-12 ***
## gender_num      1   956.65  996.65   0.734 0.3916088
## cut2(sapsi_first, g = 5) 4   991.04 1025.04 35.121 4.387e-07 ***
## cut2(sofa_first, g = 5) 4   962.39  996.39   6.467 0.1669071
## service_unit    2   962.45 1000.45   6.529 0.0382253 *
## afib_flg        1   963.01 1003.01   7.090 0.0077512 **
## renal_flg       1   960.24 1000.24   4.321 0.0376445 *
## liver_flg       1   957.70  997.70   1.780 0.1821692
## copd_flg        1   956.95  996.95   1.035 0.3088774
## stroke_flg      1 1045.73 1085.73 89.808 < 2.2e-16 ***
## mal_flg         1   961.15 1001.15   5.231 0.0221921 *
## resp_flg        1   970.13 1010.13 14.214 0.0001632 ***
## ---
## Signif. codes:  0 '***' 0.001 '**' 0.01 '*' 0.05 '.' 0.1 ' ' 1

```

where again `aline_flg` has the largest  $p$ -value, and `gender_num` has the second largest. We continue, eliminating `gender_num`, `copd_flg`, `liver_flg`, `cut2(sofa_first, g = 5)`, `renal_flg`, and `service_unit`, in that order (results omitted). The table produced by `drop1` from our final model is as follows:

```

drop1(mva.tmp.glm8,test="Chisq")

## Single term deletions
##
## Model:
## day_28_flg ~ aline_flg + age + cut2(sapsi_first, g = 5) + afib_flg +
##   stroke_flg + mal_flg + resp_flg
##
##           Df Deviance      AIC      LRT Pr(>Chi)
## <none>           989.10 1011.1
## aline_flg       1   989.10 1009.1   0.001 0.977380
## age             1 1037.65 1057.7 48.556 3.209e-12 ***
## cut2(sapsi_first, g = 5) 4 1037.88 1051.9 48.788 6.465e-10 ***
## afib_flg        1   995.60 1015.6   6.502 0.010777 *
## stroke_flg      1 1078.58 1098.6 89.485 < 2.2e-16 ***
## mal_flg         1   997.37 1017.4   8.274 0.004021 **
## resp_flg        1 1022.30 1042.3 33.200 8.317e-09 ***
## ---
## Signif. codes:  0 '***' 0.001 '**' 0.01 '*' 0.05 '.' 0.1 ' ' 1

```

All variables are statistically significant at the 0.05 significance level. Looking at the summary output, we see that `aline_flg` is not statistically significant ( $p = 0.98$ ), but all other terms are statistically significant, with the exception of the `cut2(sapsi_first, g = 5)` [12,14], which suggest that the second to

lowest SAPS group may not be statistically significantly different than the baseline (lowest SAPS group).

```
mva.final.glm <- mva.tmp.glm8;
summary(mva.final.glm)

##
## Call:
## glm(formula = day_28_flg ~ aline_flg + age + cut2(sapsi_first,
##   g = 5) + afib_flg + stroke_flg + mal_flg + resp_flg, family = "binomial",
##   data = dat)
##
## Deviance Residuals:
##   Min       1Q   Median       3Q      Max
## -2.3025  -0.4928  -0.2433  -0.1289   3.1103
##
## Coefficients:
##              Estimate Std. Error z value Pr(>|z|)
## (Intercept)    -6.081944   0.445625  -13.648 < 2e-16 ***
## aline_flg1      0.005078   0.179090   0.028  0.97738
## age            0.037205   0.005644   6.592 4.33e-11 ***
## cut2(sapsi_first, g = 5) [12,14] 0.302084   0.391502   0.772  0.44035
## cut2(sapsi_first, g = 5) [14,16] 1.127302   0.344670   3.271  0.00107 **
## cut2(sapsi_first, g = 5) [16,19] 1.030901   0.347842   2.964  0.00304 **
## cut2(sapsi_first, g = 5) [19,32] 1.883738   0.347311   5.424 5.84e-08 ***
## afib_flg1      0.522664   0.203485   2.569  0.01021 *
## stroke_flg1    1.870553   0.199980   9.354 < 2e-16 ***
## mal_flg1       0.592458   0.202297   2.929  0.00340 **
## resp_flg1      0.976808   0.171629   5.691 1.26e-08 ***
## ---
## Signif. codes:  0 '***' 0.001 '**' 0.01 '*' 0.05 '.' 0.1 ' ' 1
##
## (Dispersion parameter for binomial family taken to be 1)
##
##   Null deviance: 1413.4  on 1690  degrees of freedom
## Residual deviance:  989.1  on 1680  degrees of freedom
##   (85 observations deleted due to missingness)
## AIC: 1011.1
##
## Number of Fisher Scoring iterations: 6
```

We would call this model our final model, and would present it in a table similar to Table 16.4. Since the effect of IAC was of particular focus, we will highlight it by saying that it is not associated with 28 day mortality with an estimated adjusted odds ratio of 1.01 (95 % CI: 0.71–1.43,  $p = 0.98$ ). We may conclude that after adjusting for the other potential confounders found in Table 16.4, we do not find any statistically significant impact of using IAC on mortality.

### 16.5.4 Conclusion and Summary

This brief overview of the modeling techniques for health data has provided you with the foundation to perform the most common types of analyses in health studies. We have cited how important having a clear study objective before

**Table 16.4** Multivariable logistic regression analysis for mortality at 28 days outcome (final model)

Covariate	AOR	Lower 95 % CI	Upper 95 % CI	p-value
IAC	1.01	0.71	1.43	0.977
Age (per year increase)	1.04	1.03	1.05	<0.001
SAPSI [12–14]* (relative to SAPSI <2)	1.35	0.63	2.97	0.440
SAPSI [14–16]*	3.09	1.61	6.28	0.001
SAPSI [16–19]*	2.80	1.45	5.74	0.003
SAPSI [19–32]*	6.58	3.42	13.46	<0.001
Atrial fibrillation	1.69	1.13	2.51	0.010
Stroke	6.49	4.40	9.64	<0.001
Malignancy	1.81	1.21	2.68	0.003
Non-COPD respiratory disease	2.66	1.90	3.73	<0.001

conducting data analysis is, as it identifies all the important aspects you need to plan and execute your analysis. In particular by identifying the outcome, you should be able to determine what analysis methodology would be most appropriate. Often you will find that you will be using multiple analysis techniques for different study objectives within the same study. Table 16.5 summarizes some of the important aspects of each analysis approach.

Fortunately, R’s framework for conducting these analyses is very similar across the different types of techniques, and this framework will often extend more generally to other more complex models (including machine learning algorithms) and data structures (including dependent/correlated data such as longitudinal data).

**Table 16.5** Summary of different methods

	Linear regression	Logistic regression	Cox proportional hazards model
Outcome data type	Continuous	Binary	Time to an event (possibly censored)
Useful preliminary analysis	Scatterplot	Contingency and 2 × 2 tables	Kaplan-Meier survivor function estimate
Presentation Output	Coefficient	Odds Ratio	Hazard ratio
R output	Coefficient	Log Odds ratio	Log hazard ratio
Presentation Interpretation	An estimate of the expected change in the outcome per one unit increase in the covariate, while keeping all other covariates constant	An estimate of the fold change in the odds of the outcome per unit increase in the covariate, while keeping all other covariates constant	An estimate of the fold change in the hazards of the outcome per unit increase in the covariate, while keeping all other covariates constant

We have highlighted some areas of concern that careful attention should be paid to including missing data, colinearity, model misspecification, and outliers. Some of these items will be looked at more closely in Chap. 17.

**Open Access** This chapter is distributed under the terms of the Creative Commons Attribution-NonCommercial 4.0 International License (<http://creativecommons.org/licenses/by-nc/4.0/>), which permits any noncommercial use, duplication, adaptation, distribution and reproduction in any medium or format, as long as you give appropriate credit to the original author(s) and the source, a link is provided to the Creative Commons license and any changes made are indicated.

The images or other third party material in this chapter are included in the work's Creative Commons license, unless indicated otherwise in the credit line; if such material is not included in the work's Creative Commons license and the respective action is not permitted by statutory regulation, users will need to obtain permission from the license holder to duplicate, adapt or reproduce the material.

## References

1. Hsu DJ, Feng M, Kothari R, Zhou H, Chen KP, Celi LA (2015) The association between indwelling arterial catheters and mortality in hemodynamically stable patients with respiratory failure: a propensity score analysis. *CHEST J* 148(6):1470–1476
2. Goldberger AL, Amaral LA, Glass L, Hausdorff JM, Ivanov PC, Mark RG, Mietus JE, Moody GB, Peng C-K, Stanley HE (2000) Physiobank, physiobank, and physionet components of a new research resource for complex physiologic signals. *Circulation* 101(23):e215–e220
3. Indwelling arterial catheter clinical data from the MIMIC II database (2016) Available <http://physionet.org/physiobank/database/mimic2-iaccd/>. Accessed: 02 Jun 2016
4. Friedman J, Hastie T, Tibshirani R (2009) The elements of statistical learning: data mining, inference, and prediction. Springer series in statistics
5. James G, Witten D, Hastie T, Tibshirani R (2013) An introduction to statistical learning, vol 112. Springer, Berlin
6. Harrell F (2015) Regression modeling strategies: with applications to linear models, logistic and ordinal regression, and survival analysis. Springer, Berlin
7. Venables WN, Ripley BD (2013) Modern applied statistics with S-plus. Springer Science & Business Media
8. Weisberg S (2005) Applied linear regression, vol 528. Wiley, New York
9. Diggle P, Heagerty P, Liang KY, Zeger S (2013) Analysis of longitudinal data. OUP Oxford
10. McCullagh P, Nelder JA (1989) Generalized linear models, vol 37. CRC press, Boca Raton
11. Hosmer DW, Lemeshow S (2004) Applied logistic regression. Wiley, New York
12. Kleinbaum DG, Klein M (2006) Survival analysis: a self-learning text. Springer Science & Business Media
13. Kaplan EL, Meier P (1958) Nonparametric estimation from incomplete observations. *J Am Stat Assoc* 53(282):457–481
14. Cox DR (1972) Regression models and life-tables. *J R Stat Soc Ser B (Methodol)* 34(2):187–220
15. Collett D (2015) Modelling survival data in medical research. CRC press, Boca Raton
16. Kalbfleisch JD, Prentice RL (2011) The statistical analysis of failure time data, vol 360. Wiley, New York
17. Therneau TM, Grambsch PM (2000) Modeling survival data: extending the Cox model. Springer Science & Business Media
18. Dash M, Liu H (1997) Feature selection for classification. *Intel Data Anal* 1(3):131–156

# Chapter 17

## Sensitivity Analysis and Model Validation

Justin D. Saliccioli, Yves Crutain, Matthieu Komorowski  
and Dominic C. Marshall

### Learning Objectives

- Appreciate that all models possess inherent limitations for generalizability.
- Understand the assumptions for making causal inferences from available data.
- Check model fit and performance.

### 17.1 Introduction

Imagine that you have now finished the primary analyses of your current research and have been able to reject the null hypothesis. Even after your chosen methods have been applied and robust models generated, some doubts may remain. *“How confident are you in the results? How much will the results change if your basic data is slightly wrong? Will that have a minor impact on your results? Or will it give a completely different outcome?”* Causal inference is often limited by the assumptions made in study design and analysis and this is particularly pronounced when working with observational health data. An important approach for any investigator is to avoid relying on any single analytical approach to assess the hypothesis and as such, a critical next step is to test the assumptions made in the analysis.

Sensitivity Analysis and Model Validation are linked in that they are both attempts to assess the appropriateness of a particular model specification and to appreciate the strength of the conclusions being drawn from such a model. Whereas model validation is useful for assessing the model fit within a specific research dataset, sensitivity analysis is particularly useful in gaining confidence in the results of the primary analysis and is important in situations where a model is likely to be used in a future research investigation or in clinical practice. Herein, we discuss

concepts relating to the assessment of model fit and outline broadly the steps relating to cross and external validation with direct application to the arterial line project. We will discuss briefly a few of the common reasons why models fail validity testing and the potential implications of such failure.

## 17.2 Part 1—Theoretical Concepts

### 17.2.1 Bias and Variance

In statistics and machine learning, the bias–variance trade-off (or dilemma) is the problem of simultaneously minimizing two sources of error that prevent supervised learning algorithms from generalizing beyond their training set. A model with high bias fails to accurately estimate the data. For example, a linear regression model would have high bias when trying to model a quadratic relationship—no matter how the parameters are set (as shown in Fig. 17.1). Variance, on the other hand, relates to the stability of your model in response to new training examples. An algorithm that fits the training data very well but generalizes poorly to new examples (showing over-fitting) is said to have high variance.

Some common strategies for dealing with bias and variance are outlined below.

- High bias:
  - Adding features (predictors) tends to decrease bias, at the expense of introducing additional variance.
  - Adding training examples will not fix high bias, because the underlying model will still not be able to approximate the correct function.
- High variance:
  - Reducing model complexity can help decrease variance. Dimensionality reduction and feature selection are two examples of methods to decrease model parameters and thus reduce variance (parameter selection is discussed below).
  - A larger training set tends to decrease variance.



**Fig. 17.1** Comparison between bias and variance in model development

### 17.2.2 *Common Evaluation Tools*

A variety of statistical techniques exist to quantitatively assess the performance of statistical models. These techniques are important, but generally beyond the scope of this textbook. We will, however, briefly mention two of the most common techniques: the  $R^2$  value used for regressions and the Receiver Operating Characteristic (ROC) curve used for binary classifier (dichotomous outcome).

The  $R^2$  value is a summary statistic representing the proportion of total variance in the outcome variable that is captured by the model. The  $R^2$  has a range from 0 to 1 where values close to 0 reflect situations where the model does not appreciably summarise variation in the outcome of interest and values close to 1 indicate that the model captures nearly all of the variation in the outcome of interest. High  $R^2$  values means that a high proportion of the variance is explained by the regression model. In R programming, the  $R^2$  is computed when the linear regression function is used. For an example of R-code to produce the  $R^2$  value please refer to the “ $R^2$ ” function.

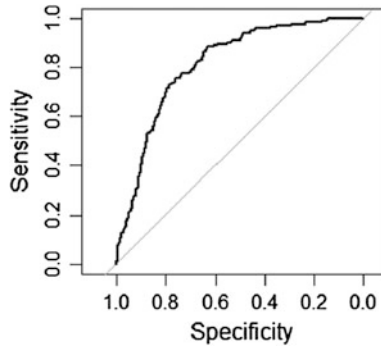
The  $R^2$  value is an overall measure of strength of association between the model and the outcome and does not reflect the contribution of any single independent predictor variable. Further, while we may expect intuitively that there is a proportional relationship between the number of predictor variables and the overall model  $R^2$ , in practice, adding predictors does not necessarily increase  $R^2$  in new data. It is possible for an individual predictor to decrease the  $R^2$  depending on how this variable interacts with the other parameters in the model.

For the purpose of this discussion we expect the reader to be familiar with the computation and utility of the values of sensitivity and specificity. In situations such as developing a new diagnostic test, investigators may define a single threshold value to classify a test result as positive. When dealing with a dichotomous outcome, the Receiver Operating Characteristic (ROC) curve is a more complete description of a model’s ability to classify outcomes. The ROC curve is a common method to show the relationship between the sensitivity of a classification model and its false positive rate (1 - specificity). The resultant Area Under the Curve of the ROC reflects the prediction estimate of the model, can take values from 0.5 to 1 with values of 0.5 implying near random chance in outcomes and values nearer to 1 reflecting greater prediction. For an example of ROC curves in R, please refer to the “ROC” function in the accompanying code. For further reading on the ROC curve, see for example the article by Fawcett [1] (Fig. 17.2).

### 17.2.3 *Sensitivity Analysis*

Sensitivity analysis involves a series of methods to quantify how the uncertainty in the output of a model is related to the uncertainty in its inputs. In other words, sensitivity analysis assesses how “sensitive” the model is to fluctuations in the parameters and data on which it is built. The results of sensitivity analysis can have





**Fig. 17.2** Example of receiver operator characteristic (ROC) curve which may be used to assess the ability of a model to discriminate between dichotomous outcomes

important implications at many stages of the modeling process, including for identifying errors in the model itself, informing the calibration of model parameters, and exploring more broadly the relationship between the inputs and outputs of the model.

The principles of a sensitivity analysis are: (a) to allow the investigator to quantify the uncertainty in a model, (b) to test the model of interest using a secondary experimental design, and (c) using the results of the secondary experimental design to calculate the overall sensitivity of the model of interest. The justification for sensitivity analysis is that a model will always perform better (i.e. over-perform) when tested on the dataset from which it was derived. Sub-group analysis is a common variation of sensitivity analysis [2].

#### 17.2.4 Validation

As discussed in Chap. 16—Data Analysis validation is used to confirm that the model of interest will perform similarly under modified testing conditions. As such, it is the primary responsibility of the investigator to assess the suitability of model fit to the data. This may be accomplished with a variety of methodological approaches and for a more detailed discussion of model fit diagnostics the reader is referred to other sources [3]. Although it is beyond the scope of this textbook to discuss validation in detail, the general theory is to select a model based on two principles: model parsimony and clinical relevance. A number of pre-defined model selection algorithm-based approaches including Forward selection, Backward, and Stepwise selection, but also lasso and genetic algorithms, available in common statistical packages. Please refer to Chap. 16 for further information about model selection.

Cross validation is a technique used to assess the predictive ability of a regression model. The approach has been discussed in detail previously [4]. The concept of cross-validation relies on the principle that a large enough dataset can

split into two or more (not necessarily equally sized) sub-groups, the first being used to derive the model and the additional data set(s) reserved for model testing and validation. To avoid losing information by training the model only on a subset of available data, a variant called k-fold cross validation exist (not discussed here).

External validation is defined as testing the model on a sample of subjects taken from a population different than the original cohort. External validation is usually a more robust approach for testing the derived model in that the maximum amount of information has been used from the initial dataset to derive a model and an entirely independent dataset is used subsequently to verify the suitability of the model of interest. Although external validation is the most rigorous and an essential validation method, finding a suitably similar albeit entirely independent cohort for external validation is challenging and is often unavailable for researchers. However, with the increasing amount of healthcare data being captured electronically it is likely that researchers will also have increasing capacity for external validation.

### **17.3 Case Study: Examples of Validation and Sensitivity Analysis**

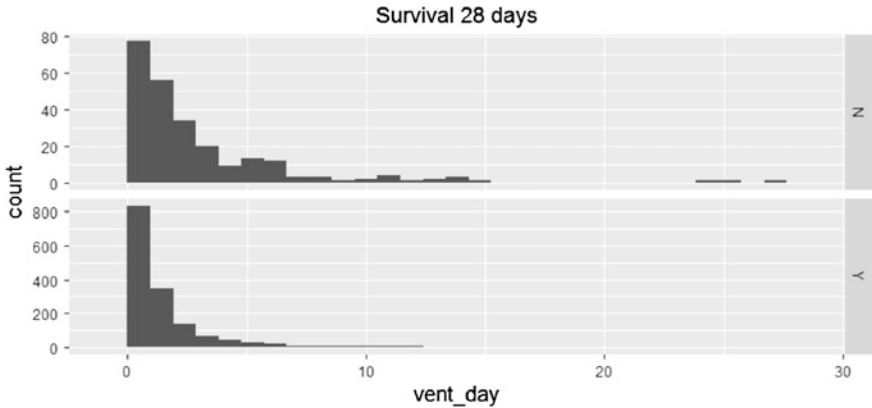
This case study used the dataset produced for the “IAC study”, which evaluated the impact of inserting an arterial line in intensive care patients with respiratory failure. Three different sensitivity analyses were performed:

1. Test the effects of varying the inclusion criteria of time to mechanical ventilation and mortality;
2. Test the effects of changes in caliper level for propensity matching on association between arterial catheter insertion and the mortality;
3. Hosmer-Lemeshow Goodness-of-Fit test to assess the overall fit of the data to the model of interest.

A number of R packages from CRAN, were used to conduct these analyses: Multivariate and Propensity Score Matching [5], analysis of complex survey samples [6], ggplot2 for generating graphics [7], pROC for ROC curves [8] and Twang for weighting and analyzing non-equivalent groups [9].

#### ***17.3.1 Analysis 1: Varying the Inclusion Criteria of Time to Mechanical Ventilation***

The first sensitivity analysis evaluates the effect of varying the inclusion criteria of time to mechanical ventilation and mortality. Mechanical ventilation is one of the more common invasive interventions performed in the ICU and the timing of intervention may serve as a surrogate for the severity of critical illness, as we might



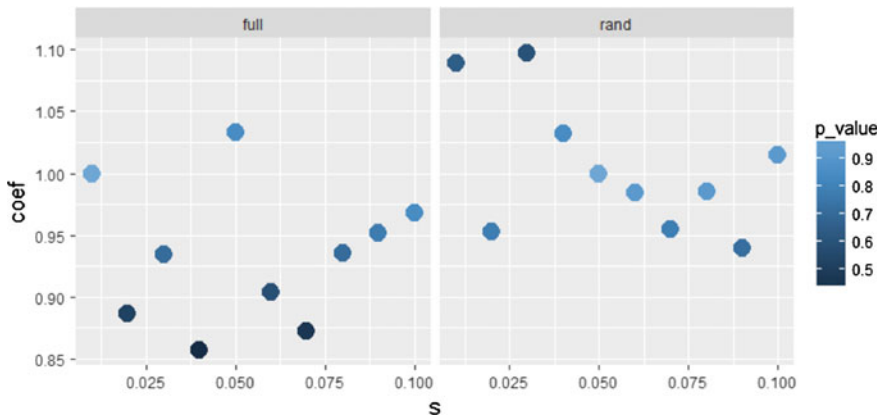
**Fig. 17.3** Simple sensitivity analysis to compare outcomes between groups by varying the inclusion criteria. Modification of the inclusion criteria for subjects entered into the model is a common sensitivity analysis

expect patients with worse illness to require assisted ventilation earlier in the course of intensive care. As such, mechanical ventilation along with indwelling arterial catheter (IAC), another invasive intervention, may both be related to the outcome of interest, 28-day mortality. An example of R-code to inspect the distribution across groups of patients by ventilation status is provided in the “Cohort” function, in the accompanying R functions document (Fig. 17.3).

By modifying the time of first assisted mechanical ventilation we may also obtain important information about the effect of the primary exposure on the outcome. An example of R-code for this analysis is provided in the “Ventilation” function.

### ***17.3.2 Analysis 2: Changing the Caliper Level for Propensity Matching***

The second sensitivity analysis performed tests the impact of different caliper levels for propensity matching on the association between arterial catheter and the mortality. In this study, the propensity score matches a subject who did not received an arterial catheter with a subject who did. The matching algorithm creates a pair of two independent subjects whose propensity scores are the most similar. However, the investigator is responsible for setting a maximum reasonable difference in propensity score which would allow the matching algorithm to generate a suitable match; this maximum reasonable difference is also known as the propensity score ‘caliper’. The choice of caliper for the propensity score match will directly influence the variance bias trade-off such that a wider caliper will result in matching of subjects which are more dissimilar with respect to likelihood of treatment. An



**Fig. 17.4** A sensitivity analysis to assess the effect of modifying the propensity score caliper level

example of the R-code to produce a sensitivity analysis for varying the propensity score caliper level is provided in the accompanying R functions document as the “Caliper” function.

The Fig. 17.4 displays the effect of adjustments of the caliper level on the propensity score. The full model shows a lower coefficient due to the presence of additional variables.

### 17.3.3 Analysis 3: Hosmer-Lemeshow Test

The Hosmer-Lemeshow Goodness-of-Fit test may be used to assess the overall fit of the data to the model of interest [10]. For this test, the subjects are grouped according to a percentile of risk (usually deciles). A Pearson Chi square statistic is generated to compare observed subject grouping with the expected risk according to the model. An example of the R-code to conduct this test is provided in the accompanying R functions document as the “HL” function.

### 17.3.4 Implications for a ‘Failing’ Model

In the favorable situation of a robust model, each sensitivity analysis and validation technique supports the model as an appropriate summary of the data. However, in some situations, the chosen validation method or sensitivity analysis reveals an inadequate fit of the model for the data such that the model fails to accurately predict the outcome of interest. A ‘failing’ model may be the result of a number of different factors. Occasionally, it is possible to modify the model derivation

procedure in order to claim a better fit on the data. In the situations where modifying the model does not allow to achieve an acceptable level of error, however, it is good practice to renounce the investigation and re-start with an assessment of the a priori assumptions, in an attempt to develop a different model.

## 17.4 Conclusion

The analysis of observational health data carries the inherent limitation of unmeasured confounding. After model development and primary analysis, an important step is to confirm a model's performance with a series of confirmatory tests to verify a valid model. While validation may be used to check that the model is an appropriate fit for the data and is likely to perform similarly in other cohorts, sensitivity analysis may be used to interrogate inherent assumptions of the primary analysis. When performed adequately these additional steps help improve the robustness of the overall analysis and aid the investigator in making meaningful inferences from observational health data.

### Take Home Messages

1. Validation and sensitivity analyses test the robustness of the model assumptions and are a key step in the modeling process;
2. The key principle of these analyses is to vary the model assumptions and observe how the model responds;
3. Failing the validation and sensitivity analyses might require the researcher to start with a new model.

**Open Access** This chapter is distributed under the terms of the Creative Commons Attribution-NonCommercial 4.0 International License (<http://creativecommons.org/licenses/by-nc/4.0/>), which permits any noncommercial use, duplication, adaptation, distribution and reproduction in any medium or format, as long as you give appropriate credit to the original author(s) and the source, a link is provided to the Creative Commons license and any changes made are indicated.

The images or other third party material in this chapter are included in the work's Creative Commons license, unless indicated otherwise in the credit line; if such material is not included in the work's Creative Commons license and the respective action is not permitted by statutory regulation, users will need to obtain permission from the license holder to duplicate, adapt or reproduce the material.

## Code Appendix

The code used in this chapter is available in the GitHub repository for this book: <https://github.com/MIT-LCP/critical-data-book>. Further information on the code is available from this website.

## References

1. Fawcett T (2006) An introduction to ROC analysis. *Pattern Recogn Lett* 27(8):861–874
2. Brookes ST, Whitely E, Egger M, Smith GD, Mulheran PA, Peters TJ (2004) Subgroup analyses in randomized trials: risks of subgroup-specific analyses; power and sample size for the interaction test. *J Clin Epidemiol* 57(3):229–236
3. Pregibon D (1981) Logistic regression diagnostics. *Ann Stat* 9(4):705–724
4. Picard RR, Cook RD (1984) Cross-validation of regression models. *J Am Stat Assoc* 79(387):575–583
5. Sekhon JS (2011) Multivariate and propensity score matching software with automated balance optimization: the matching package for R. *J Stat Softw* 42(i07)
6. Lumley T (2004) Analysis of complex survey samples. *J Stat Softw* 09(i08)
7. Wickham H (2009) *ggplot2*. Springer, New York
8. Robin X, Turck N, Hainard A, Tiberti N, Lisacek F, Sanchez J-C, Müller M (2011) pROC: an open-source package for R and S + to analyze and compare ROC curves. *BMC Bioinf* 12:77
9. Ridgeway G, Mccaffrey D, Morral A, Burgette L, Griffin BA (2006) Twang: toolkit for weighting and analysis of nonequivalent groups. R package version 1.4-9.3. In: R Foundation for Statistical Computing, 2006. (<http://www.cran.r-project.org>). Accessed 2015
10. Hosmer DW, Lemeshow S (1980) Goodness of fit tests for the multiple logistic regression model. *Commun Stat Theory Methods* 9(10):1043–1069

# Part III

## Case Studies Using MIMIC

### Introduction

This section presents twelve case studies of secondary analyses of electronic health records (EHRs). The case studies exhibit a wide range of research topics and methodologies, making them of interest to a wide range of researchers. They are written primarily for the beginner, although the experienced researcher will also benefit much from the detailed explanations offered by experts in the field. The case studies provide an opportunity to thoroughly engage with high-level research studies, since they are accompanied by both publicly available data and analytical code. This section should not be approached as a continuous narrative. Rather, each case study can be read independently. Indeed, it is advisable to begin with those which lie closest to your interests. An overview of the research areas and methodologies of the case studies is now provided.

The case studies are ordered according to their research areas. The first two case studies concern system-level analyses, beginning with an analysis of the trends in clinical practice with regard to mechanical ventilation (Chap. 18). This is followed by an investigation into the effect of caring for critically-ill patients in “non-target ICUs”, otherwise known as boarding, on mortality (Chap. 19). The next three case studies focus on mortality prediction using a plethora of inputs such as demographics, vital signs and laboratory test results (Chaps. 20–22). Two case studies investigate the effectiveness of a clinical intervention, with assessments of clinical effectiveness (Chap. 23) and cost effectiveness (Chap. 24). A study of the relationship between blood pressure and the risk of Acute Kidney Injury is presented, illustrating the physiological insights that can be gained by analysis of EHRs (Chap. 25). Two case studies are then presented on monitoring techniques: an investigation into the estimation of respiratory rate, a key physiological parameter, from routinely acquired physiological signals (Chap. 26); and a detailed study of the potential for false alarm reduction using machine learning classification techniques (Chap. 27). Finally two studies consider particular aspects of research methodology, focusing on patient cohort identification (Chap. 28) and mathematical techniques for selection of hyperparameters (Chap. 29).

A plethora of methodologies are demonstrated in the case studies. The machine learning techniques used include: regression, support vector machines, decision trees (Chap. 21), random forest classification (Chap. 27), Markov models (Chap. 24), and a Super Learner algorithm to fuse multiple techniques (Chap. 20). Other analytical approaches include instrumental variable analysis (Chap. 19), propensity score matching (Chap. 23), case-control and case-crossover designs (Chap. 25), signal processing (Chaps. 26 and 27), and natural language processing (Chap. 28).

The aim of this section is to provide readers with examples of secondary EHR analyses to empower them in their own research. We hope that the clinical relevance of the investigations will inspire researchers to realize the full potential of EHRs for the benefit of the patients of tomorrow. The detailed descriptions of study methodologies are intended to provide an understanding of the nuances of EHR analyses. Finally, a range of tools are available to underpin novel investigations: both the data and the analytical code used in this Section are publicly available. Further details of these tools are provided in the accompanying GitHub repository: <https://github.com/MIT-LCP/critical-data-book>.



# Chapter 18

## Trend Analysis: Evolution of Tidal Volume Over Time for Patients Receiving Invasive Mechanical Ventilation

Anuj Mehta, Franck DERNONCOURT and Allan Walkey

### Learning Objectives

Learn the importance of trend analysis

- To understand epidemiological changes in health and delivery of healthcare.
- To assess the implementation of new evidence into clinical practice.
- Assess real world effectiveness of discoveries (interrupted time series design; difference in differences, regression discontinuity).

Learn methods of performing trend analysis

- Cochrane-Armitage test for trend.
- Differences Logistic/linear regression analysis with time as an independent variable.

Addressing changes in aspects of the study population over time with relation to the main dependent and independent variables

- Adjustment/confounding.
- Interaction of covariates with time and outcomes.

Refining the research question

- Addressing limitations in the data.

### 18.1 Introduction

Healthcare is a dynamic field that is constantly evolving in response to changes in disease epidemiology, population demographics, and new discoveries. Epidemiologic changes in disease prevalence and outcomes have important implications for determining healthcare resource allocation. For example, identifying trends that show increasing utilization of invasive mechanical ventilation may

suggest local or societal needs for more intensive care unit beds, critical care nurses and physicians, and mechanical ventilators. Additionally, changes in healthcare outcomes over time can provide insight into the adoption of new scientific knowledge and identify targets for quality improvement where implementation of evidence has been slow or where results from tightly-controlled trials are not realized in the “real world”. Trend analyses utilize statistical methods in an attempt to quantify changes to better understand the evolution of health and healthcare delivery.

To highlight the uses of trend analysis, we present a study evaluating how scientific evidence supporting treatment of one condition may be generalized by healthcare professionals to other conditions in which the treatment is untested. We investigated adoption of evidence supporting lower tidal volumes during mechanical ventilation for patients admitted to the medical intensive care unit (MICU) compared to the cardiac care unit (CCU).

Critically ill patients can develop severe difficulty breathing and may require the assistance of a breathing machine (ventilator) through a process called invasive mechanical ventilation. Patients may require invasive mechanical ventilation for a wide variety of conditions such as pneumonia, asthma, and heart failure. In some cases, the lungs fall victim to massive inflammation triggered by severe systemic diseases such as infection, trauma, or aspiration. The inflammation leads to leakage of fluid into the lungs (pulmonary edema) in a condition called the acute respiratory distress syndrome (ARDS). ARDS is defined by four criteria [1]:

1. Acute in nature
2. Bilateral infiltrates on chest x-ray
3. Not caused by heart failure (as heart failure can also cause pulmonary edema)
4. Severe hypoxia defined by the partial pressure of arterial oxygen to fraction of inspired oxygen (P/F) ratio

Regardless of the cause of respiratory failure, many patients receiving invasive mechanical ventilation develop ARDS.

Mechanical Ventilators are most often set to deliver one volume of air for each breath (i.e. tidal volume). Too much air delivered during each breath can cause over-stretch and injury to already impaired lungs, resulting in yet further damage by the systemic release of inflammatory chemicals. In the setting of ARDS, large tidal volumes cause already inflamed lungs to release more inflammatory chemicals that can cause further lung damage but also damage to other organs. Based on the theory that lower tidal volumes may act to protect the lungs and other organs by decreasing lung over-distention and release of inflammatory chemicals during invasive mechanical ventilation, a landmark study demonstrated that use of lower tidal volumes for patients receiving invasive mechanical ventilation with ARDS resulted in an absolute mortality reduction of 8.8 % [2]. Since then, several studies have demonstrated improvements in mortality over time for patients with ARDS [3–6] as well as a reduction in the tidal volumes used in all patients in MICUs [3, 7].

Because the definition of ARDS strictly excludes patients with heart failure, patients with heart failure have been excluded from studies evaluating effects and

epidemiology of tidal volume reduction. In order to fill current knowledge gaps regarding tidal volume selection among patients with heart failure, we sought to use trend analysis to explore temporal changes in tidal volumes among patients with heart failure as compared to patients with ARDS. In order to address difficulties with identifying the indication for mechanical ventilation in electronic health records, we adjusted our analytic plan to focus on trends in tidal volume selection in CCUs (where heart failure is the most common cause of invasive mechanical ventilation) as compared to MICUs (where most patients with ARDS receive care).

## 18.2 Study Dataset

In this case study we used the Medical Information Mart for Intensive Care II (MIMIC-II) database version 3 [8], which contains de-identified, granular patient-level information for 48,018 patients across 57,995 ICU hospitalizations at a single academic center from 2002 to 2011. The MIMIC II Clinical Database is a relational database that contains individual values for a variety of patient variables such as lab results, vital signs, and billing codes.

## 18.3 Study Pre-processing

We identified patients in MIMIC-II who received invasive mechanical ventilation. We excluded patients <18 years of age; pediatric critical care practices and the physiology of pediatric patients differ from adult patients. While we initially sought to compare patients with ARDS to patients with heart failure, accurate identification of specific indications for mechanical ventilation in electronic health records was difficult and subject to misclassification. Thus, we selected patients admitted to the MICU as a surrogate for patients with ARDS [3, 7] and patients admitted to the CCU as a surrogate for patients with heart failure. We excluded patients whose initial ICU service was a surgical ICU as the majority of patients would likely have been receiving invasive mechanical ventilation for routine post-operative care. For patients who were admitted to multiple different intensive care units (ICU) during a single hospitalization, we based inclusion/exclusion criteria on the initial ICU admission. We further excluded patients who had missing data on tidal volume.

## 18.4 Study Methods

Our primary outcome was average tidal volume ordered by clinicians during assist-control ventilation. We used the Cochran-Armitage test for trends to evaluate changes over time in the percentage of patients in each unit who required

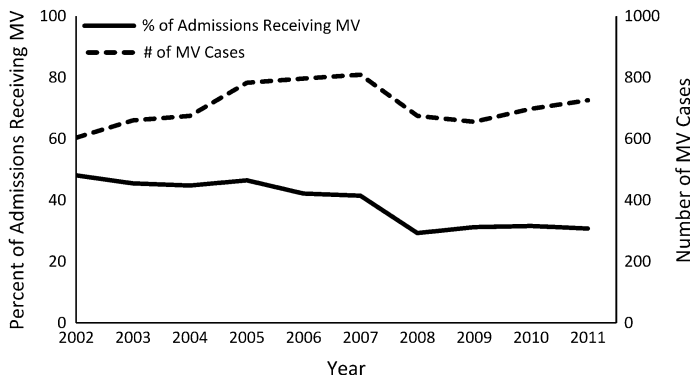
invasive mechanical ventilation. We calculated the average tidal volume for the entire period of assisted invasive mechanical ventilation for each patient and then calculated the average of tidal volumes for the MICU and CCU each year. In order to assess for a temporal trend in tidal volume, we performed multivariable linear regression (see Sect. 5.2 in Chap. 5 on Data Analysis for details) stratified by ICU type. Analyses for trends in tidal volume change over time included a dependent (outcome) variable of tidal volume and independent variable (exposure) of time (year of intensive care admission). Year of admission is a common time variable chosen for trend analysis. Smaller sample sizes can result in large amounts of noise and fluctuations when analyzing shorter time frames such as ‘month’. We chose multivariable linear regression because tidal volume is a continuous variable and because regression techniques allowed for adjustment of effect estimates for possible confounders of the relationship between time and tidal volume. We adjusted for patient age and gender as both could affect tidal volume selection. To determine differences in tidal volume trends between the MICU and CCU, we included an interaction term between time and patient location in regression models. In order to determine if variability in average tidal volumes had changed over time, we compared the coefficient of variation (standard deviation normalized to the sample mean) at the beginning of the study to the end of the study, in each unit [9]. All testing was done at an alpha level = 0.05.

All studies were deemed exempt by the Institutional Review Boards of Boston Medical Center and Beth Israel Deaconess. All statistical testing was performed with SAS 9.4 (Cary, NC).

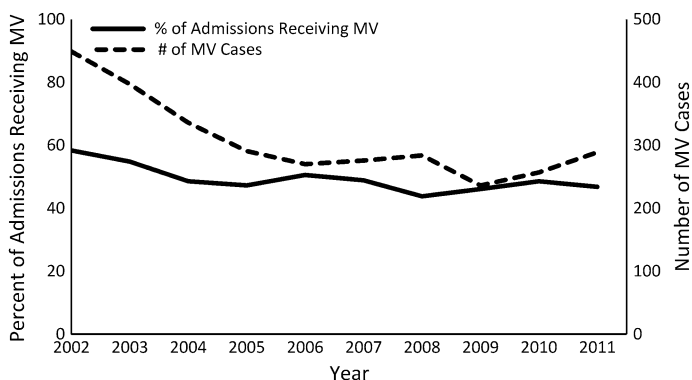
## 18.5 Study Analysis

We identified 7083 patients receiving invasive mechanical ventilation in the MICU and 3085 patients in the CCU from 2002 to 2011. The number of patients receiving invasive mechanical ventilation in the MICU fluctuated during the study period, but the net change was consistent with a 20.2 % increase in mechanical ventilation between 2002 and 2011. The percentage of MICU patients who received invasive mechanical ventilation decreased from 48.1 % in 2002 to 30.8 % in 2011 ( $p < 0.0001$  for trend) (Fig. 18.1). Thus, the driver of increasing mechanical ventilation utilization was a rising MICU census rather than a greater likelihood of using mechanical ventilation among MICU patients. In contrast to trends in the MICU, mechanical ventilation in the CCU declined by 35.6 %, with trends driven by a lower CCU census and a reduction in the proportion of patients receiving invasive mechanical ventilation decreased (from 58.4 % in 2002 to 46.8 % in 2011) ( $p < 0.0001$  for trend) (Fig. 18.2).

Average tidal volumes in the CCU decreased by 24.4 % over the study period, from 661 mL (SD = 132 mL) in 2002 to 500 mL (SD = 59) in 2011 ( $p < 0.0001$ ).

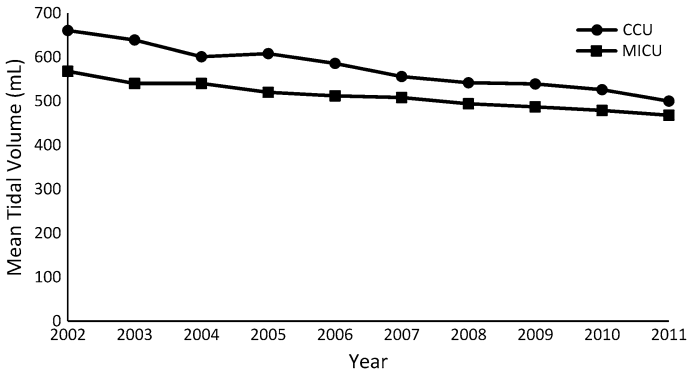


**Fig. 18.1** Percent of all admissions (*left y-axis*) and number of cases (*right y-axis*) receiving invasive mechanical ventilation in the MICU. *MV*—invasive mechanical ventilation, *MICU*—medical intensive care unit



**Fig. 18.2** Percent of all admissions (*left y-axis*) and number of cases (*right y-axis*) receiving invasive mechanical ventilation in the CCU. *MV*—invasive mechanical ventilation, *CCU*—cardiac care unit

Tidal volume in the MICU decreased by 17.6 %, from 568 mL (SD = 121 mL) in 2002 to 468 mL (SD = 65 mL) in 2011 ( $p < 0.0001$ ) (Fig. 18.3). During each year of the study period, the CCU used higher tidal volumes than the MICU ( $p < 0.0001$  for comparison between units for each year). After adjusting for age and gender, tidal volume in the CCU decreased by an average of 18 mL per year (95 % CI 16–19 mL,  $p < 0.0001$ ) while tidal volumes in the MICU decreased by 11 mL per year (95 % CI 10–11,  $p < 0.0001$ ). The decrease in tidal volume in the CCU was greater than the decrease in the MICU ( $p_{\text{interaction}} < 0.0001$ ). Additionally, the coefficient of variation decreased in both units during the study period (MICU: 20.0 % in 2002 to 11.8 % in 2011,  $p < 0.0001$ ; CCU: 21.3 % in 2002 to 13.9 % in 2011,  $p < 0.0001$ ).



**Fig. 18.3** Average tidal volume in the MICU and CCU per year. For each year, the average tidal volume was higher in the CCU,  $p < 0.0001$  for comparison for each year. The decrease (slope) of the change in tidal volume was greater for the CCU,  $p < 0.001$ . *MICU*—medical intensive care unit. *CCU*—cardiac care unit

## 18.6 Study Conclusions

While there is strong evidence indicating survival benefits for lower tidal volumes in patients with non-cardiogenic pulmonary edema (ARDS) [2] there is little evidence for its use in patients with cardiogenic pulmonary edema (heart failure). Using the MIMIC-II database, we identified a decrease in rates of invasive mechanical ventilation in both the MICU and CCU, despite an increase in the actual number of invasive mechanical ventilation cases in the MICU. Tidal volumes decreased in both ICUs over the course of the study period. Interestingly, tidal volumes decreased at a faster rate in the CCU as compared to the MICU, with tidal volumes nearly equivalent in the MICU and CCU by 2011. The more rapid rate of tidal volume decline in the CCU occurred despite little evidence supporting use of low tidal volumes for patients with cardiogenic pulmonary edema or heart failure. In addition to declining tidal volumes, variability in tidal volume selection also declined over time, demonstrating an evolving tendency towards greater uniformity in tidal volume selection. Our findings demonstrate a generalization of the evidence for ARDS towards the treatment of patients previously excluded from studies investigating tidal volumes during mechanical ventilation.

## 18.7 Next Steps

Our analysis has several limitations. First, many factors affect tidal volume choice in ICUs including patient height, respiratory drive, and acid/base status. If these unmeasured factors were to have changed over time in our study population, they would be potential confounders of our observation that tidal volumes have been set

lower over time. Including covariates related to these factors in the regression analysis could reduce possible confounding. For the purposes of this case study, we limited our covariates to demographic characteristics, but others could be added to the model in future analyses. Second, our primary outcome variable is mean tidal volume. We did not look at changes in tidal volumes during a patient's hospitalization, an analysis that may also be performed in future studies. Third, tidal volumes are generally normalized to the ideal body weight, as normal lung size correlates with ideal body weight. We did not have ideal body weights available in MIMIC-II.

The next step from this study would be determine associations between changes in tidal volume and changes in clinical outcomes. Studies attempting to assess the association of changing tidal volumes with clinical outcomes would need to be vigilant to measure multiple potentially confounding variables that may have been co-linear secular trends along with decreasing tidal volumes. Additionally, we used patients admitted to the MICU as a surrogate for patients with ARDS and to the CCU as a surrogate for patients with heart failure. In future studies we would hope to refine our search algorithms within EHR databases to be able to identify patients with ARDS and heart failure with minimal risk of misclassification bias. The strengths of EHR databases such as MIMIC-II lie in their unique granularity, providing a wealth of opportunities to measure clinical details such as pharmacy data, laboratory results, physician notes (via natural language processing), etc., that allow a greater ability to attenuate confounding.

## 18.8 Connections

Trend analyses assess health care changes over time. In our case study we used linear regression techniques to determine the association of time on a continuous variable (tidal volume). Regression methods allow researchers to account for confounding variables that may have changed over time along with exposures and outcomes of interest. However linear regression techniques are limited to data that have a linear relationship. For non-linear data, transformation techniques (e.g. log-transformation) can be used to convert a nonlinear distribution to a more linear relationship, higher-order polynomial regression, or spline regression may be used; alternatively Poisson regression may be used for count data.

Other techniques should be used for categorical outcomes. The Cochran-Armitage test for trends is a modified Pearson chi-squared test that allows for ordering of one of the variables (i.e. a time variable). Additionally multivariable logistic regression tools allow for trend analysis for categorical data with the potential for addition of possible confounders as covariates.

These analytic techniques can be applied broadly beyond our case study. The fundamental aspect of trend analyses stems from the fact that the main independent/exposure variable is time. With this concept, numerous conditions and treatments can be studied to see how their utilization changes over time such as

subgroups of patients receiving invasive mechanical ventilation [10], patients with tracheostomy [11], etc. Trend analysis is important to evaluate how well clinical trial findings have penetrated usual care by assessing changes in trends with relationship to new research findings or new guidelines. Additionally, trend analyses are critical for quality assessment in determining if certain interventions or process have significantly changed outcomes. As with all statistics, one must understand the assumptions involved in the types of tests being performed and ensure that the data meet those criteria.

**Open Access** This chapter is distributed under the terms of the Creative Commons Attribution-NonCommercial 4.0 International License (<http://creativecommons.org/licenses/by-nc/4.0/>), which permits any noncommercial use, duplication, adaptation, distribution and reproduction in any medium or format, as long as you give appropriate credit to the original author(s) and the source, a link is provided to the Creative Commons license and any changes made are indicated.

The images or other third party material in this chapter are included in the work's Creative Commons license, unless indicated otherwise in the credit line; if such material is not included in the work's Creative Commons license and the respective action is not permitted by statutory regulation, users will need to obtain permission from the license holder to duplicate, adapt or reproduce the material.

## Code Appendix

The code used in this case study is available from the GitHub repository accompanying this book: <https://github.com/MIT-LCP/critical-data-book>. Further information on the code is available from this website.

## References

1. The ARDS Definition Task Force (2012) Acute respiratory distress syndrome: the Berlin definition. *JAMA* 307(23):2526–2533
2. Amato MB, Barbas CS, Medeiros DM, Laffey JG, Engelberts D, Kavanagh BP (2000) Ventilation with lower tidal volumes as compared with traditional tidal volumes for acute lung injury and the acute respiratory distress syndrome. The acute respiratory distress syndrome network. *N Engl J Med* 342(18):1301–1308
3. Esteban A, Frutos-Vivar F, Muriel A et al (2013) Evolution of mortality over time in patients receiving mechanical ventilation. *Am J Respir Crit Care Med* 188(2):220
4. Rubenfeld GD, Caldwell E, Peabody E et al (2005) Incidence and outcomes of acute lung injury. *N Engl J Med* 353(16):1685–1693
5. Erickson SE, Martin GS, Davis JL et al (2009) Recent trends in acute lung injury mortality: 1996–2005. *Crit Care Med* 37(5):1574–1579
6. Zambon M, Vincent JL (2008) Mortality rates for patients with acute lung injury/ARDS have decreased over time. *Chest* 133(5):1120–1127
7. Esteban A, Ferguson ND, Meade MO et al (2008) Evolution of mechanical ventilation in response to clinical research. *Am J Respir Crit Care Med* 177(2):170–177



8. Scott DJ, Lee J, Silva I et al (2013) Accessing the public MIMIC-II intensive care relational database for clinical research. *BMC Med Inform Decis Mak* 13:9. doi:10.1186/1472-6947-13-9
9. United States Forest Service (2015) A likelihood ratio test of the equality of the coefficients of variation of k normally distributed populations. <http://www1.fpl.fs.fed.us/covtestk.html>. 28 July 2015
10. Mehta AB, Syeda SN, Wiener RS et al (2015) Epidemiological trends in invasive mechanical ventilation in the United States: a population-based study. *J Crit Care* 30(6):1217–1221
11. Mehta AB, Syeda SN, Bajpayee L et al (2015) Trends in tracheostomy for mechanically ventilated patients in the United States, 1993–2012. *Am J Respir Crit Care Med* 192(4):446–454

# Chapter 19

## Instrumental Variable Analysis of Electronic Health Records

Nicolás Della Penna, Jennifer P. Stevens and Robert Stretch

### Learning Objectives

In this case study we illustrate how to

- Estimate causal effects of a potential intervention when there is an instrumental variable available.
- Identify appropriate model classes with which to estimate effects using instrumental variables.
- Examine potential sources of treatment effect heterogeneity.

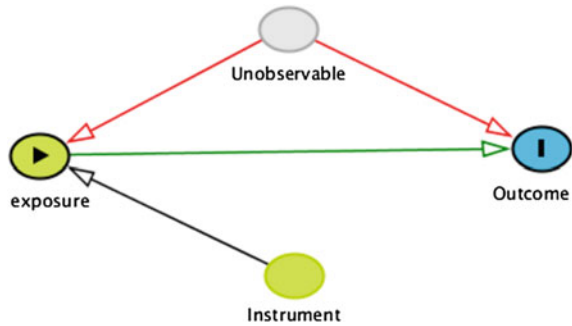
## 19.1 Introduction

The goal of observational research is to identify the causal effects of exposures or treatments on clinical outcomes of interest. The availability of data derived from electronic health records (EHRs) has improved the feasibility of large-scale observational studies. However, both treatments and patient characteristics (covariates) affect outcomes. Since in general the two are dependent, it is not accurate to simply compare the outcomes of those receiving different treatments to decide which treatment is more effective. While regression analysis can account for the variation in those covariates that can be observed, estimates remain biased if there are unobservable covariates that affect treatment propensity and outcomes.

Idealized randomized controlled experiments overcome the problem of unobserved covariates by virtue of them being randomly distributed in a balanced manner between the treatment and control groups as the sample size becomes large. In practice, however, such experiments are affected by participant non-compliance. Instrumental variable techniques, which use treatment assignment as the instrument and actual treatment taken as the endogenous variables (those that result from choices that may be affected by unobservables), are useful in this setting.

Instrumental variable analyses (IVAs) attempt to exploit “natural experiments”—sources of unintentional but effective randomization of subjects to

**Fig. 19.1** Instrumental variable analyses employ instruments that affect the likelihood of the exposure but do not otherwise affect the outcome



different treatments. To take advantage of such natural experiments, subjects must find themselves in a situation in which some observable characteristic makes them more likely to receive a specified treatment, but does not otherwise affect the outcome of interest, and is independent of unobservable covariates (see Fig. 19.1). The estimation then relies on using only the variation caused by this observable characteristic, called an *instrument* or *instrumental variable (IV)*, to identify the effect.

There are three key considerations in the selection of appropriate controls and valid instruments:

1. **Control variables should be pre-treatment characteristics of the patients or providers:** One should not control for outcomes or decisions that occur after the treatment, even if they are not the outcome of interest, as this would bias results. Drawing the causal model and analyzing the paths provides a principled way of understanding the underlying assumptions that are being made. Web-based software [1] is available to facilitate this.
2. **The instrument must be correlated with the treatment and explain a substantial portion of the variation in the treatment:** The less variation in the treatment that the instrument explains (the “weaker” the instrument), the higher the variance of the estimates obtained. This higher variance may deny any benefits from bias reduction.
3. **The instrument must be independent of the outcome through any mechanism other than the treatment:** This remains one of the greatest challenges of employing IVAs accurately in medical data, as identifying instruments that have no relationship with any unobservable clinical variation beyond the treatment is difficult.

To illustrate these concepts we propose using an IVA to estimate the effect on intensive care unit (ICU) mortality of receiving care in a “non-target” ICU, defined as a unit that has a different specialty focus than the ICU to which patients would have been assigned in the absence of capacity constraints. For example, patients being cared for by a medical ICU team ideally care for their patients in a defined

geographic area designated as the medical ICU (MICU), but when no beds are available in that unit a patient may instead be assigned to an unoccupied bed in a non-target ICU such as a surgical ICU (SICU). In this study, we define those patients assigned beds in non-target ICUs as *boarders*.

Although the physicians of the MICU team retain responsibility for the care of boarders, most other staff involved in the patient's care (e.g. nurses, respiratory therapists, physical therapists) will change as a result of boarding status. This is because these staff are assigned to a specific geographically-defined ICU such as the SICU. As a result, boarders are typically cared for by nurses and other staff who possess expertise more appropriate for managing surgical patients than medical patients. Additionally, since physicians and nurses who work in different ICUs may not be as familiar with each other's clinical practices, communication difficulties can arise. Lastly, there are also greater geographic distances between boarders and their physicians compared to non-boarders. This can contribute to delays in care and impairment of a physician's level of situational awareness. It therefore seems reasonable to hypothesize that boarding may negatively impact upon clinical outcomes, including survival.

## 19.2 Methods

### 19.2.1 Dataset

The Medical Information Mart for Intensive Care (MIMIC-III) database contains clinical and administrative data on over 60,000 ICU stays at Beth Israel Deaconess Medical Center (BIDMC) between 2001 and 2012. It includes operational-level data on bed assignments and service transfers, as well as ICD-9-CM diagnoses and several mortality measures (ICU stay mortality, hospital mortality, and survival duration up to one year).

### 19.2.2 Methodology

#### *Cohort Selection*

We included all adult subjects, aged 18 years or older, cared for by the MICU at any point during their admission. The study period was defined as June, 2002 through December, 2012. In order to ensure independence of observations only the last ICU admission for each subject was included in the analysis.

Exclusion criteria included subjects whose primary hospital team at any point during their admission was non-medical (i.e. surgical or cardiac), as this might imply a specific reason aside from capacity constraints for a patient to be a boarder

in a non-medical ICU (for example, a postoperative subject in the surgical ICU being transferred from the surgical ICU team to the medical ICU team for persistent respiratory failure).

The final study population included 8442 subjects, of whom 1881 (22 %) were exposed to the effects of boarding.

### ***Statistical Approach***

A naive estimate of the effect of boarding on mortality would compare the outcomes of patients who were boarders to those who were not. However, the decision to board a patient is not random. It takes into account the level of severity of a given patient's condition, as well as how that compares with the severity levels of other incoming patients also in need of an ICU bed. It is likely that much of the information that informs this decision is unobservable. As a consequence, if we conducted this study as a simple regression analysis we would obtain biased estimates of the effect of boarding.

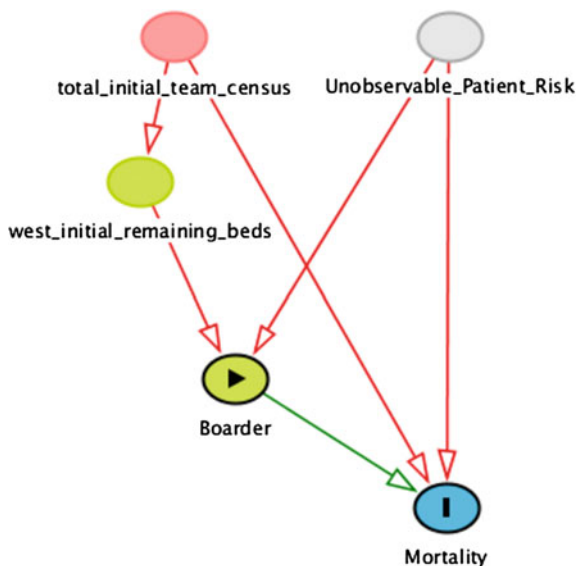
For example, assume that boarding *increases* mortality, but also that ICU staff preferentially select *less* severely ill patients to be boarders. In this hypothetical scenario, the *observed* association between boarding and mortality could appear protective if the negative effect of boarding on mortality is smaller than the positive effect on observed mortality of selecting healthier patients. While one may, and should, control for patients' severity of illness and pre-existing health levels, it is not usually possible to observe these with the same granularity and accuracy as the hospital staff who decide whether the patient will become a boarder. As a result, boarders may still be healthier than non-boarders even after conditioning on a measure of severity of illness.

An IVA is an attractive approach in this situation. In this study, we focus on MICU patients. We propose that the number of remaining available beds in the western campus MICU at time of patient intake (*west\_initial\_remaining\_beds*) may serve as a valid instrument for boarding status. It is important to note that *west\_initial\_remaining\_beds* does not include beds that are available outside of the MICU (i.e. beds to which boarders can be assigned). The boarder status of the patient is the *causal variable* and the *outcome* is death during ICU stay (Fig. 19.2).

The Oxford Acute Severity of Illness Score (OASIS) is employed to help account for residual differences between the health status of boarders and non-boarders at the time of their intake into the ICU. OASIS is an ICU scoring system that has been shown to have non-inferior performance characteristics relative to APACHE (Acute Physiology and Chronic Health Evaluation), MPM (Mortality Probability Model), and SAPS (Simplified Acute Physiology Score) [2]. We preferentially use OASIS for severity of illness adjustment because its scores can be more accurately reconstructed in MIMIC-III in a retrospective manner than the aforementioned alternatives.

At times when hospital load is high, the total number of patients being cared for by the ICU team (*west\_initial\_team\_census*) is likely to be high, and

**Fig. 19.2** Simplified causal diagram illustrating confounding of the relationship between boarding and mortality due to unobservable heterogeneity in patient risk, and potential conditional instrument *west\_initial\_remaining\_beds*. The diagram can be manipulated at <http://dagitty.net/dags.html?id=AVKMi0>



*west\_initial\_remaining\_beds* is likely to be low. Furthermore, it is plausible that higher values of *west\_initial\_team\_census* might affect mortality as a relatively fixed quantity of ICU resources (e.g. physicians) is stretched across a greater number of patients.

At first it may be unclear why there is imperfect correlation between *west\_initial\_team\_census* and *west\_initial\_remaining\_beds*, as one might anticipate that the number of remaining beds is simply inversely proportional to the total number of patients being cared for by the ICU team. The source of variation between these variables is two-fold. The primary driver is the stochastic pattern of ICU discharges. It is improbable that all boarders will be discharged prior to any of the non-boarders. Discharging a non-boarder while other patients remain as boarders creates a situation where the total team census may continue to be higher than the bed capacity of the MICU, yet the number of available beds in the MICU becomes non-zero. The second, smaller source of variation is occupancy of MICU beds by patients being cared for by other ICU teams (e.g. a SICU patient boarding in the MICU).

Using *west\_initial\_remaining\_beds* as an instrument is therefore valid, but we must control for *west\_initial\_team\_census*. To check that *west\_initial\_remaining\_beds* is correlated to the propensity of patients to board, we fit a generalized additive model with a logistic link function.

Once a natural experiment has been identified and the validity of the instrumental variable confirmed, an IVA can be conducted to estimate the causal effect of the treatment. The standard in the econometrics literature has been to use a two-step ordinary least squares (OLS) regression. There are two important limitations to this approach in biomedical settings. Firstly, it requires continuous treatment and outcome variables, both of which tend to be discrete or binary in medical applications.

Secondly, it requires knowledge of the functional form of the underlying relationships such that the data can be transformed to make the relationships linear in the parameters of the estimated model. This is often beyond what is known in the biomedical field.

Several approaches have been developed to address these limitations. Probit models are part of a family of generalized linear models (GLM) that is well suited to working with discrete data, thereby addressing the first aforementioned limitation. Furthermore, use of a basis expansion may allow the functional form to be approximated flexibly using penalized splines, substantially relaxing the second limitation related to knowledge of functional forms. At least one statistical package, *SemiParBIVProbit* for R, combines these two approaches in an accessible implementation.

In addition to the probit model, we used the *survival* package for R to estimate a non-instrumental Cox proportional hazards model as a robustness check. In order to minimize selection bias in this non-instrumental model, we used a subset of the dataset in which it is intuitive that selective pressures would be reduced or non-existent: *west\_initial\_remaining\_beds* equal to zero (all patients must board irrespective of their severity of illness) or *west\_initial\_remaining\_beds* greater than or equal to three (no imminent capacity constraint exerting pressure on physicians to board patients). The linear assumptions of the Cox models are strong and not justified *a priori*, therefore in order to test for potential nonlinearities in the instrumental model we used the *Vuong and Clarke* tests of the *SemiParBIVProbit* package.

All of our models included controls for patient age, gender, OASIS and Elixhauser comorbidity scores, length of hospital stay prior to ICU admission, and calendar year. In addition to controlling for the *west\_initial\_team\_census*, we also controlled for the total number of boarders under the care of the MICU team.

### 19.2.3 Pre-processing

We used a software package called *Chatto-Transform* [3] that connects to a local PostgreSQL instance of MIMIC-III and simplifies the process of importing table data into an interactive *Jupyter* notebook [4]. Python 3 and the *Pandas* library [5] were used for data extraction and analysis (see code supplement).

The publicly available version of MIMIC-III applies random time-shifts to records to help prevent subjects from being identified. After institutional review board approval, we obtained the exact dates and bed assignments for each subject's ICU stay and used this to reconstruct the entire hospital ICU census.

The *services* table in MIMIC-III documents the specific service (e.g. medicine, general surgery, cardiology) responsible for a patient at a given moment in time. The service providing MICU care is classified as 'medicine'. Therefore general medicine patients who are initially admitted to a ward and later require a MICU bed will still only have one entry per admission in this table, provided that they are not transferred to the care of a different service. We consider a refined copy of the

*services* table (*med\_service\_only*) that retains only those rows pertaining to patients cared for exclusively by the medicine service during their stay. The resulting table therefore has only one row per hospital admission.

The *transfers* table documents every change in a patient's location during their hospital admission, including exact bed assignments and timestamp data. A new table *df* can be created by performing a left join between *transfers* and *med\_service\_only*. In the resulting table, rows pertaining to the population of interest (i.e. medicine patients who incurred a MICU stay at some point during their admission) will have data corresponding to both the left (*transfers*) and right (*med\_service\_only*) tables. Rows pertaining to all other patients will only have data from the *transfers* table. We further subdivide this table into *inboarders* (which contains rows pertaining to non-MICU patients occupying beds in the MICU) and *df5* (which contains rows pertaining to our population of interest).

Looping through each row in *df5*, we identify rows in *inboarders* that represent a MICU bed occupied by a non-MICU patient at the time a MICU patient began their ICU stay. We also determine whether the new MICU patient was assigned a bed outside the geographic confines of the MICU, in which case they were classified as a boarder. Lastly, a count of the total number of patients being cared for by the MICU team is generated and added to each row of *df5*. These variables allow for calculation of the number of remaining MICU beds through the formula:

$$\text{Remaining Beds} = (\text{MICU Capacity} - \text{No. of Inboarders}) - (\text{Team Census} - \text{No. of Boarders})$$

*Death during ICU stay* was determined *a priori* to be our primary outcome of interest. We identified a number of instances in the dataset where death occurred within minutes or hours of discharge from the ICU. This was most likely due to combination of expected deaths (subjects transitioned to comfort-focused care who were transferred out of the ICU shortly prior to death), unexpected deaths, and minor time discrepancies inherent to large datasets that include administrative details. Prior to data analysis it was decided that our preferred definition of *death during ICU stay* would include those within 24 h of leaving the ICU.

### 19.3 Results

Looking at the fitted models, we observe an increase in mortality from boarding across the different specifications. In the semiparametric bivariate probit model, using the *west\_initial\_remaining\_beds* as an instrument, the estimated causal [6] average risk ratio is 1.44 (95 % interval: 1.17, 1.79). In the non-instrumental Cox proportional hazards model we observe a similar estimate of 1.34 (1.06, 1.70).

Often treatments result in different effects of different patients, thus it is sensible to think of average treatment effects (ATE). Instrumental variable analyses, however, restrict the estimation to the variation in the data that is attributable to the



instrument. That is, the effect they estimate is the *local* effect on those patients whose treatment is affected by the instrument. This is termed the Local Average Treatment Effect (LATE), and is what is estimated by an IVA when there is heterogeneity in treatment effects.

## 19.4 Next Steps

Much of the existing medical literature utilizing IVAs has addressed policy questions as opposed to the effect of medical treatments. This has been driven by the interest in such questions by health care economists, as well as the greater availability and suitability of administrative—rather than clinical—data within the medical field. In contrast, the growing adoption and increasing sophistication of EHRs now presents us with an opportunity to investigate the effects of medical treatments through their provision of a rich source of observable variables and potential instruments. Examples include measurable variation in the number and characteristics of hospital staff, as well as load levels that cause spillover between units and thus are exogenous to a particular patient in a given unit. There is also a large body of literature that has explored Mendelian randomization as a source of instruments, however these usually create limited variation therefore instrument weakness is a substantial concern.

Aside from serving as candidate instruments or controls, some variables easily extracted from EHRs may be useful for checking the plausibility of a proposed pseudo-randomization process: if an instrument is truly randomizing patients with respect to a treatment then we would expect a balanced distribution of a wide range of observable variables (e.g. patient demographics). This is akin to tables that compare the baseline characteristics between groups in the results of randomized controlled trial. Estimating causal effects from natural experiments is an important part of the econometrics literature. For an influential practitioners reference, see *Mostly Harmless Econometrics* [7]. A excellent counterpoint can be found in part III of Shalizi [8].

Instrumental variables are powerful tools in the identification of causal relationships, but it is critical to remain mindful of potential sources of confounding. Garabedian et al. reviewed the studies published in the medical literature using IVAs and found that the four most commonly used instrument categories—distance to facility, regional variation, facility variation, and physician variation—all suffered from “potential unadjusted instrument–outcome confounders ... including patient race, socioeconomic status, clinical risk factors, health status, and urban or rural residency; facility and procedure volume; and co-occurring treatments” [9].

## 19.5 Conclusions

This case study demonstrates the steps involved in the identification and validation of an instrumental variable. It also illustrates the process of conducting an IVA to estimate effect sizes and infer causal relationships from observational data.

The results of our study support the hypothesis that boarding of critically ill patients has deleterious effects on ICU survival. We recommend that institutions take steps to minimize boarding among ICU patients and that further studies be undertaken to more precisely characterize the effect size. Better understanding of the mediators through which boarding influences mortality is also important, and may help to identify groups of patients who are able to board without detrimental effects, and those for whom boarding should be particularly avoided.

**Open Access** This chapter is distributed under the terms of the Creative Commons Attribution-NonCommercial 4.0 International License (<http://creativecommons.org/licenses/by-nc/4.0/>), which permits any noncommercial use, duplication, adaptation, distribution and reproduction in any medium or format, as long as you give appropriate credit to the original author(s) and the source, a link is provided to the Creative Commons license and any changes made are indicated.

The images or other third party material in this chapter are included in the work's Creative Commons license, unless indicated otherwise in the credit line; if such material is not included in the work's Creative Commons license and the respective action is not permitted by statutory regulation, users will need to obtain permission from the license holder to duplicate, adapt or reproduce the material.

## Code Appendix

The code used in this case study is available from the GitHub repository accompanying this book: <https://github.com/MIT-LCP/critical-data-book>. Further information on the code is available from this website.

## References

1. Textor J, Hardt J, Knüppel S (2011) DAGitty: a graphical tool for analyzing causal diagrams. *Epidemiology* 22(5):745
2. Johnson AEW, Kramer AA, Clifford GD (2013) A new severity of illness scale using a subset of acute physiology and chronic health evaluation data elements shows comparable predictive accuracy. *Crit Care Med* 41(7):1711–1718
3. Spitz D, Spencer D (2015) Chatto-transform
4. Jupyter Team, “Project Jupyter.”
5. PyData Development Team (2015) Pandas data analysis library
6. Marra G, Giampiero M, Rosalba R (2011) Estimation of a semiparametric recursive bivariate probit model in the presence of endogeneity. *Can J Stat* 39(2):259–279

7. Angrist JD, Pischke J-S (2008) Mostly harmless econometrics: an empiricist's companion. Princeton University Press, Princeton
8. Shalizi CR (2016) Advanced data analysis from an elementary point of view, 18 Jan 2016
9. Garabedian LF, Chu P, Toh S, Zaslavsky AM, Soumerai SB (2014) Potential bias of instrumental variable analyses for observational comparative effectiveness research. *Ann Intern Med* 161(2):131–138

# Chapter 20

## Mortality Prediction in the ICU Based on MIMIC-II Results from the Super ICU Learner Algorithm (SICULA) Project

Romain Pirracchio

### Learning Objectives

In this chapter, we illustrate the use of MIMIC II clinical data, non-parametric prediction algorithm, ensemble machine learning, and the Super Learner algorithm.

### 20.1 Introduction

Predicting mortality in patients hospitalized in intensive care units (ICU) is crucial for assessing severity of illness and adjudicating the value of novel treatments, interventions and health care policies. Several severity scores have been developed with the objective of predicting hospital mortality from baseline patient characteristics, defined as measurements obtained within the first 24 h after ICU admission. The first scores proposed, APACHE [1] (Acute Physiology and Chronic Health Evaluation), APACHE II [2], and SAPS [3] (Simplified Acute Physiology Score), relied upon subjective methods for variable importance measure, namely by prompting a panel of experts to select and assign weights to variables according to perceived relevance for mortality prediction. Further scores, such as the SAPS II [4] were subsequently developed using statistical modeling techniques [4–7]. To this day, the SAPS II [4] and APACHE II [2] scores remain the most widely used in clinical practice. However, since first being published, they have been modified several times in order to improve their predictive performance [6–11]. Despite these extensions of SAPS, predicted hospital mortality remains generally overestimated [8, 9, 12–14]. As an illustration, Poole et al. [9] compared the SAPS II and the SAPS3 performance in a cohort of more than 28,000 admissions to 10 different Italian ICUs. They concluded that both scores provided unreliable predictions, but unexpectedly the newer SAPS 3 turned out to overpredict mortality more than the

older SAPS II. Consistently, Nassar et al. [8] assessed the performance of the APACHE IV, the SAPS 3 and the Mortality Probability Model III [MPM(0)-III] in a population admitted at 3 medical-surgical Brazilian intensive care units and found that all models showed poor calibration, while discrimination was very good for all of them.

Most ICU severity scores rely on a logistic regression model. Such models impose stringent constraints on the relationship between explanatory variables and risk of death. For instance, main term logistic regression relies on the assumption of a linear and additive relationship between the outcome and its predictors. Given the complexity of the processes underlying death in ICU patients, this assumption might be unrealistic.

Given that the true relationship between risk of mortality in the ICU and explanatory variables is unknown, we expect that prediction can be improved by using an automated nonparametric algorithm to estimate risk of death without requiring any specification about the shape of the underlying relationship. Indeed, nonparametric algorithms offer the great advantage of not relying on any assumption about the underlying distribution, which make them more suited to fit such complex data. Some studies have evaluated the benefit of nonparametric approaches, namely based on neural networks or data-mining, to predict hospital mortality in ICU patients [15–20]. These studies unanimously concluded that nonparametric methods might perform at least as well as standard logistic regression in predicting ICU mortality.

Recently, the *Super Learner* was developed as a nonparametric technique for selecting an optimal regression algorithm among a given set of candidate algorithms provided by the user [21]. The *Super Learner* ranks the algorithms according to their prediction performance, and then builds an aggregate algorithm obtained as the optimal weighted combination of the candidate algorithms. Theoretical results have demonstrated that the *Super Learner* performs no worse than the optimal choice among the provided library of candidate algorithms, at least in large samples. It capitalizes on the richness of the library it builds upon and generally offers gains over any specific candidate algorithm in terms of flexibility to accurately fit the data.

The primary aim of this study was to develop a scoring procedure for ICU patients based on the *Super Learner* using data from the Medical Information Mart for Intensive Care II (MIMIC-II) study [22–24], and to determine whether it results in improved mortality prediction relative to the SAPS II, the APACHE II and the SOFA scores. Complete results of this study have been published in 2015 in the *Lancet Respiratory Medicine* [25]. We also wished to develop an easily-accessible user-friendly web implementation of our scoring procedure, even despite the complexity of our approach (<http://webapps.biostat.berkeley.edu:8080/sicula/>).

## 20.2 Dataset and Pre-processing

### 20.2.1 Data Collection and Patients Characteristics

The MIMIC-II study [22–24] includes all patients admitted to an ICU at the Beth Israel Deaconess Medical Center (BIDMC) in Boston, MA since 2001. For the sake of the present study, only data from MIMIC-II version 26 (2001–2008) on adult ICU patients were included. Patients younger than 16 years were not included. For patients with multiple admission, we only considered the first ICU stay. A total of 24,508 patients were included in this study.

### 20.2.2 Patient Inclusion and Measures

Two categories of data were collected: clinical data, aggregated from ICU information systems and hospital archives, and high-resolution physiologic data (waveforms and time series of derived physiologic measurements), recorded on bedside monitors. Clinical data were obtained from the CareVue Clinical Information System (Philips Healthcare, Andover, Massachusetts) deployed in all study ICUs, and from hospital electronic archives. The data included time-stamped nurse-verified physiologic measurements (e.g., hourly documentation of heart rate, arterial blood pressure, pulmonary artery pressure), nurses' and respiratory therapists' progress notes, continuous intravenous (IV) drip medications, fluid balances, patient demographics, interpretations of imaging studies, physician orders, discharge summaries, and ICD-9 codes. Comprehensive diagnostic laboratory results (e.g., blood chemistry, complete blood counts, arterial blood gases, microbiology results) were obtained from the patient's entire hospital stay including periods outside the ICU. In the present study, we focused exclusively on outcome variables (specifically, ICU and hospital mortality) and variables included in the SAPS II [4] and SOFA scores [26].

We first took an inventory of all available recorded characteristics required to evaluate the different scores considered. Raw data from the MIMIC II database version 26 were then extracted. We decided to use only R functions (without any SQL routines) as most of our researchers only have R package knowledge. Each table within each patient datafile were checked for the different characteristics and extracted. Finally, we created a global CSV file including all data and easily manipulable with R.

Baseline variables and outcomes are summarized in Table 20.1.

**Table 20.1** Baseline characteristics and outcome measures

	Overall population (n = 24,508)	Dead at hospital discharge (n = 3002)	Alive at hospital discharge (n = 21,506)
Age	65 [51–77]	74 [59–83]	64 [50–76]
Gender (female)	13,838 (56.5 %)	1607 (53.5 %)	12,231 (56.9 %)
First SAPS	13 [10–17]	18 [14–22]	13 [9–17]
First SAPS II	38 [27–51]	53 [43–64]	36 [27–49]
First SOFA	5 [2–8]	8 [5–12]	5 [2–8]
Origin			
Medical	2453 (10 %)	240 (8 %)	2213 (10.3 %)
Trauma	7703 (31.4 %)	1055 (35.1 %)	6648 (30.9 %)
Emergency surgery	10,803 (44.1 %)	1583 (52.7 %)	9220 (42.9 %)
Scheduled surgery	3549 (14.5 %)	124 (4.1 %)	3425 (15.9 %)
Site			
MICU	7488 (30.6 %)	1265 (42.1 %)	6223 (28.9 %)
MSICU	2686 (11 %)	347 (11.6 %)	2339 (10.9 %)
CCU	5285 (21.6 %)	633 (21.1 %)	4652 (21.6 %)
CSRU	8100 (33.1 %)	664 (22.1 %)	7436 (34.6 %)
TSICU	949 (3.9 %)	93 (3.1 %)	856 (4 %)
HR (bpm)	87 [75–100]	92 [78–109]	86 [75–99]
MAP (mmHg)	81 [70–94]	78 [65–94]	82 [71–94]
RR (cpm)	14 [12–20]	18 [14–23]	14 [12–18]
Na (mmol/l)	139 [136–141]	138 [135–141]	139 [136–141]
K (mmol/l)	4.2 [3.8–4.6]	4.2 [3.8–4.8]	4.2 [3.8–4.6]
HCO <sub>3</sub> (mmol/l)	26 [22–28]	24 [20–28]	26 [23–28]
WBC (10 <sup>3</sup> /mm <sup>3</sup> )	10.3 [7.5–14.4]	11.6 [7.9–16.9]	10.2 [7.4–14.1]
P/F ratio	281 [130–447]	174 [90–352]	312 [145–461]
Ht (%)	34.7 [30.4–39]	33.8 [29.8–38]	34.8 [30.5–39.1]
Urea (mmol/l)	20 [14–31]	28 [18–46]	19 [13–29]
Bilirubine (mg/dl)	0.6 [0.4–1]	0.7 [0.4–1.5]	0.6 [0.4–0.9]
Hospital LOS (days)	8 [4–14]	9 [4–17]	8 [4–14]
ICU death (%)	1978 (8.1 %)	1978 (65.9 %)	–
Hospital death (%)	3002 (12.2 %)	–	–

Continuous variables are presented as median [InterQuartile Range]; binary or categorical variables as count (%)

## 20.3 Methods

### 20.3.1 Prediction Algorithms

The primary outcome measure was hospital mortality. A total of 1978 deaths occurred in ICU (estimated mortality rate: 8.1 %, 95 %CI: 7.7–8.4), and 1024 additional deaths were observed after ICU discharge, resulting in an estimated hospital mortality rate of 12.2 % (95 %CI: 11.8–12.7).

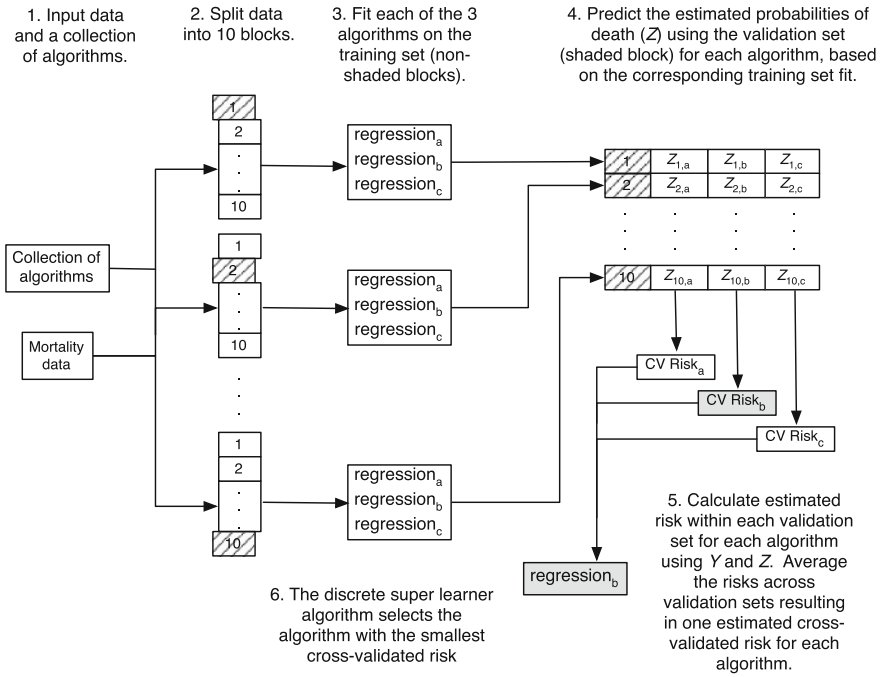
The data recorded within the first 24 h following ICU admission were used to compute two of the most widely used severity scores, namely the SAPS II [4] and SOFA [26] scores. Individual mortality prediction for the SAPS II score was calculated as defined by its authors [4]:

$$\log \left[ \frac{\text{pr}(\text{death})}{1 - \text{pr}(\text{death})} \right] = -7.7631 + 0.0737 * \text{SAPSII} + 0.9971 * \log(1 + \text{SAPSII})$$

In addition, we developed a new version of the SAPS II score, by fitting to our data a main-term logistic regression model using the same explanatory variables as those used in the original SAPS II score [4]: age, heart rate, systolic blood pressure, body temperature Glasgow Coma Scale, mechanical ventilation, PaO<sub>2</sub>, FiO<sub>2</sub>, urine output, BUN (blood urea nitrogen), blood sodium, potassium, bicarbonates, bilirubin, white blood cells, chronic disease (AIDS, metastatic cancer, hematologic malignancy) and type of admission (elective surgery, medical, unscheduled surgery). The same procedure was used to build a new version of the APACHE II score [2]. Finally, because the SOFA score [26] is widely used in clinical practice as a proxy for outcome prediction, it was also computed for all subjects. Mortality prediction based on the SOFA score was obtained by regressing hospital mortality on the SOFA score using a main-term logistic regression. These two algorithms for mortality prediction were compared to our *Super Learner*-based proposal.

The *Super Learner* has been proposed as a method for selecting via cross-validation the optimal regression algorithm among all weighted combinations of a set of given candidate algorithms, henceforth referred to as the library [21, 27, 28] (Fig. 20.1). To implement the *Super Learner*, a user must provide a customized collection of various data-fitting algorithms. The *Super Learner* then estimates the risk associated to each algorithm in the provided collection using cross-validation. One round of cross-validation involves partitioning a sample of data into complementary subsets, performing the analysis on one subset (called the *training set*), and validating the analysis on the other subset (called the *validation set* or *testing set*). To reduce variability, multiple rounds of cross-validation are performed using different partitions, and the validation results are averaged over the rounds. From this estimation of the risk associated with each candidate algorithm, the *Super Learner* builds an aggregate algorithm obtained as the optimal weighted combination of the candidate algorithms. Theoretical results suggest that to optimize the performance of the





**Fig. 20.1** Super learner algorithm. From van der Laan, targeted learning 2011 (with permission) [41]

resulting algorithm, the inputted library should include as many sensible algorithms as possible.

In this study, the library size was limited to 12 algorithms (list available in the Appendix) for computational reasons. Among these 12 algorithms, some were parametric such as logistic regression of affiliated methods classically used for ICU scoring systems, and some non-parametric i.e. methods that fit the data without any assumption concerning the underlying data distribution. In the present study, we chose the library to include most of parametric (including regression models with various combinations of main and interaction terms as well as splines, and fitted using maximum likelihood with or without penalization) and nonparametric algorithm, previously evaluated for the prediction of mortality in critically ill patients in the literature. The main term logistic regression is the parametric algorithm that has been used for constructing both the SAPS II and APACHE II scores. This algorithm was included in the SL library so that revised fits of the SAPS II score based on the current data also competed against other algorithms.

Comparison of the 12 algorithms relied on 10-fold cross-validation. The data are first split into 10 mutually exclusive and exhaustive blocks of approximately equal size. Each algorithm is fitted on a the 9 blocks corresponding to the training set and then this fit used to predict mortality for all patients in the remaining block used a

validation set. The squared errors between predicted and observed outcomes are averaged. The performance of each algorithm is evaluated in this manner. This procedure is repeated exactly 10 times, with a different block used as validation set every time. Performance measures are aggregated over all 10 iterations, yielding a cross-validated estimate of the mean-squared error (CV-MSE) for each algorithm. A crucial aspect of this approach is that for each iteration not a single patient appears in both the training and validation sets. The potential for overfitting, wherein the fit of an algorithm is overly tailored to the available data at the expense of performance on future data, is thereby mitigated, as overfitting is more likely to occur when training and validation sets intersect.

Candidate algorithms were ranked according to their CV-MSE and the algorithm with least CV-MSE was identified. This algorithm was then refitted using all available data, leading to a prediction rule referred to as the *Discrete Super Learner*. Subsequently, the prediction rule consisting of the CV-MSE-minimizing weighted convex combination of all candidate algorithms was also computed and refitted on all data. This is what we refer to as the *Super Learner* combination algorithm [28].

The data used in fitting our prediction algorithm included the 17 variables used in the SAPS II score: 13 physiological variables (age, Glasgow coma scale, systolic blood pressure, heart rate, body temperature, PaO<sub>2</sub>/FiO<sub>2</sub> ratio, urinary output, serum urea nitrogen level, white blood cells count, serum bicarbonate level, sodium level, potassium level and bilirubin level), type of admission (scheduled surgical, unscheduled surgical, or medical), and three underlying disease variables (acquired immunodeficiency syndrome, metastatic cancer, and hematologic malignancy derived from ICD-9 discharge codes). Two sets of predictions based on the *Super Learner* were produced: the first based on the 17 variables as they appear in the SAPS II score (SL1), and the second, on the original, untransformed variables (SL2).

### 20.3.2 Performance Metrics

A key objective of this study was to compare the predictive performance of scores based on the *Super Learner* to that of the SAPS II and SOFA scores. This comparison hinged on a variety of measures of predictive performance, described below.

1. A mortality prediction algorithm is said to have adequate discrimination if it tends to assign higher severity scores to patients that died in the hospital compared to those that did not. We evaluated discrimination using the cross-validated area under the receiver-operating characteristic curve (AUROC), reported with corresponding 95 % confidence interval (95 % CI). Discrimination can be graphically illustrated using the receiver-operating (ROC) curves. Additional tools for assessing discrimination include boxplots of predicted probabilities of death for survivors and non-survivors, and

corresponding discrimination slopes, defined as the difference between the mean predicted risks in survivors and non-survivors. All these are provided below.

2. A mortality prediction algorithm is said to be adequately calibrated if predicted and observed probabilities of death coincide rather well. We assessed calibration using the Cox calibration test [9, 29, 30]. Because of its numerous shortcomings, including poor performance in large samples, the more conventional Hosmer-Lemeshow statistic was avoided [31, 32]. Under perfect calibration, a prediction algorithm will satisfy the logistic regression equation ‘observed log-odds of death =  $\alpha + \beta \cdot$  predicted log-odds of death’ with  $\alpha = 0$ . To implement the Cox calibration test, a logistic regression is performed to estimate  $\alpha$  and  $\beta$ ; these estimates suggest the degree of deviation from ideal calibration. The null hypothesis  $(\alpha, \beta) = (0, 1)$  is tested formally using a U-statistic [33].
3. Summary reclassification measures, including the Continuous Net Reclassification Index (cNRI) and the Integrated Discrimination Improvement (IDI), are relative metrics which have been devised to overcome the limitations of usual discrimination and calibration measures [34–36]. The cNRI comparing severity score A to score B is defined as twice the difference between the proportion of non-survivors and of survivors, respectively, deemed more severe according to score A rather than score B. The IDI comparing severity score A to score B is the average difference in score A between survivors and non-survivors minus the average difference in score B between survivors and non-survivors. Positive values of the cNRI and IDI indicate that score A has better discriminative ability than score B, whereas negative values indicate the opposite. We computed the reclassification tables and associated summary measures to compare each *Super Learner* proposal to the original SAPS II score and each of the revised fits of the SAPS II and APACHE II scores.

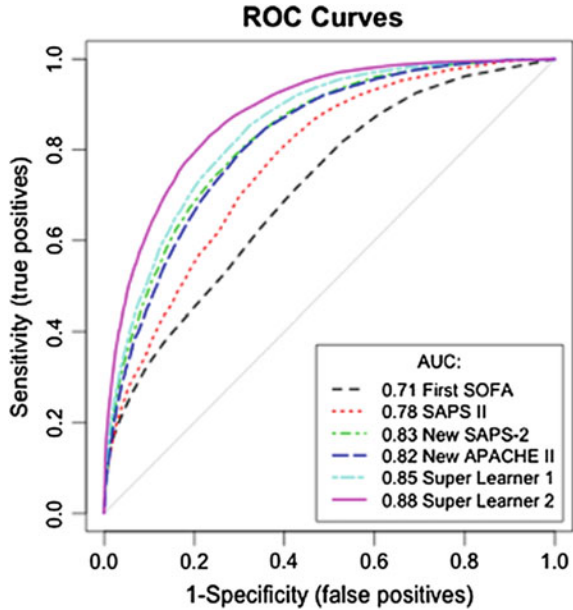
All analyses were performed using statistical software R version 2.15.2 for Mac OS X (The R Foundation for Statistical Computing, Vienna, Austria; specific packages: cvAUC, Super Learner and ROCR). Relevant R codes are provided in Appendix.

## 20.4 Analysis

### 20.4.1 Discrimination

The ROC curves for hospital mortality prediction are provided below (Fig. 20.2). The cross-validated AUROC was 0.71 (95 %CI: 0.70–0.72) for the SOFA score, and 0.78 (95 %CI: 0.77–0.78) for the SAPS II score. When refitting the SAPS II score on our data, the AUROC reached 0.83 (95 %CI: 0.82–0.83); this is similar to the results obtained with the revised fit of the APACHE II, which led to an AUROC of 0.82 (95 %CI: 0.81–0.83). The two *Super Learner* (SL1 and SL2) prediction models substantially outperformed the SAPS II and the SOFA score. The AUROC

**Fig. 20.2** Receiver-operating characteristics curves. Super learner 1: super learner with categorized variables; super learner 2: super learner with non-transformed variables



was 0.85 (95 %CI: 0.84–0.85) for SL1, and 0.88 (95 %CI: 0.87–0.89) for SL2, revealing a clear advantage of the Super Learner-based prediction algorithms over both the SOFA and SAPS II scores.

Discrimination was also evaluated by comparing differences between the predicted probabilities of death among the survivors and the non-survivors using each prediction algorithm. The discrimination slope equaled 0.09 for the SOFA score, 0.26 for the SAPS II score, 0.21 for SL1, and 0.26 for SL2.

### 20.4.2 Calibration

Calibration plots (Fig. 20.3) indicate a lack of fit for the SAPS II score. The estimated values of  $\alpha$  and  $\beta$  were of  $-1.51$  and  $0.72$  respectively ( $U$  statistic = 0.25,  $p < 0.0001$ ). The calibration properties were markedly improved by refitting the SAPS II score:  $\alpha < 0.0001$  and  $\beta = 1$  ( $U < 0.0001$ ,  $p = 1.00$ ). The prediction based on the SOFA and the APACHE II scores exhibited excellent calibration properties, as reflected by  $\alpha < 0.0001$  and  $\beta = 1$  ( $U < 0.0001$ ,  $p = 1.00$ ). For the Super Learner-based predictions, despite  $U$ -statistics significantly different from zero, the estimates of  $\alpha$  and  $\beta$  were close to the null values: SL1: 0.14 and 1.04, respectively ( $U = 0.0007$ ,  $p = 0.0001$ ); SL2: 0.24 and 1.25, respectively ( $U = 0.006$ ,  $p < 0.0001$ ).

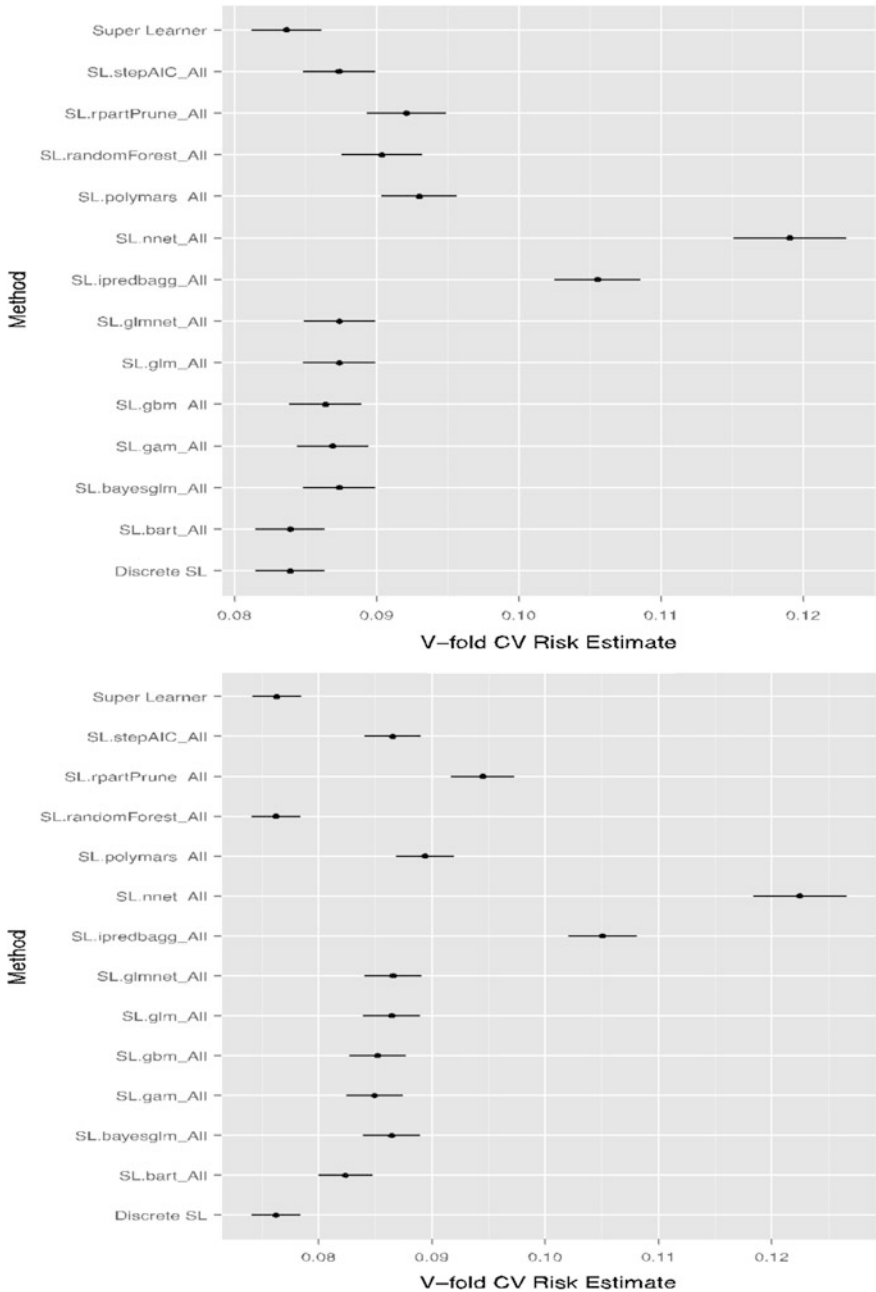


Fig. 20.3 Calibration and discrimination plots for SAPS 2 (upper panel) and SL1 (lower panel)

### 20.4.3 *Super Learner Library*

The performance of the 12 candidate algorithms, the Discrete *Super Learner* and the *Super Learner* combination algorithms, as evaluated by CV-MSE and CV-AUROC, are illustrated in Fig. 20.4.

As suggested by theory, when using either categorized variables (SL1) or untransformed variables (SL2), the *Super Learner* combination algorithm achieved the same performance as the best of all 12 candidates, with an average CV-MSE of 0.084 (SE = 0.001) and an average AUROC of 0.85 (95 %CI: 0.84–0.85) for SL1 [best single algorithm: Bayesian Additive Regression Trees, with CV-MSE = 0.084 and AUROC = 0.84 (95 %CI: 0.84, 0.85)]. For the SL2, the average CV-MSE was of 0.076 (SE = 0.001) and the average AUROC of 0.88 (95 %CI: 0.87–0.89) [best single algorithm: Random Forests, with CV-MSE = 0.076 and AUROC = 0.88 (95 %CI: 0.87–0.89)]. In both cases (SL1 and SL2), the *Super Learner* outperformed the main term logistic regression used to develop the SAPS II or the APACHE II score [main term logistic regression: CV-MSE = 0.087 (SE = 0.001) and AUROC = 0.83 (95 %CI: 0.82–0.83)].

### 20.4.4 *Reclassification Tables*

The reclassification *tables involving the SAPS II score in its original and its actualized versions, the revised APACHE II score, and the SL1 and SL2 scores* are provided in Table 20.2. When compared to the classification provided by the original SAPS II, the actualized SAPS II or the revised APACHE II score, the *Super Learner*-based scores resulted in a downgrade of a large majority of patients to a lower risk stratum. This was especially the case for patients with a predicted probability of death above 0.5.

We computed the cNRI and the IDI considering each *Super Learner* proposal (score A) as the updated model and the original SAPS II, the new SAPS II and the new APACHE II scores (score B) as the initial model. In this case, positive values of the cNRI and IDI would indicate that score A has better discriminative ability than score B, whereas negative values indicate the opposite. For SL1, both the cNRI (cNRI = 0.088 (95 %CI: 0.050, 0.126),  $p < 0.0001$ ) and IDI (IDI =  $-0.048$  (95 %CI:  $-0.055, -0.041$ ),  $p < 0.0001$ ) were significantly different from zero. For SL2, the cNRI was significantly different from zero (cNRI = 0.247 (95 %CI: 0.209, 0.285),  $p < 0.0001$ ), while the IDI was close to zero (IDI =  $-0.001$  (95 %CI:  $-0.010, -0.008$ ),  $p = 0.80$ ). When compared to the classification provided by the actualized SAPS II, the cNRI and IDI were significantly different from zero for both SL1 and SL2: cNRI = 0.295 (95 %CI: 0.257, 0.333),  $p < 0.0001$  and IDI = 0.012 (95 %CI: 0.008, 0.017),  $p < 0.0001$  for SL1; cNRI = 0.528 (95 %CI: 0.415, 0.565),  $p < 0.0001$  and IDI = 0.060 (95 %CI: 0.054, 0.065),  $p < 0.0001$  for SL2. When compared to the actualized APACHE II score, the cNRI and IDI were also

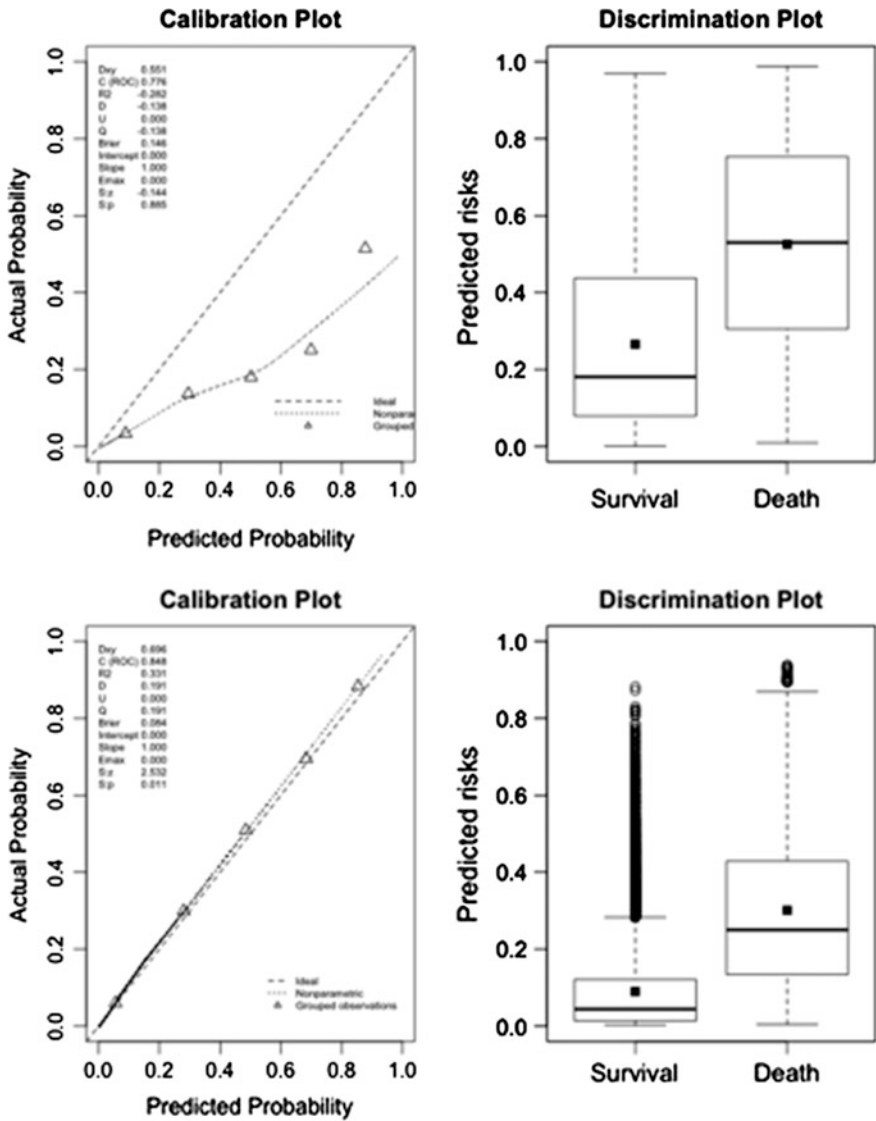


Fig. 20.4 Cross-validated mean-squared error for the super learner and the 12 candidate algorithms included in the library. Upper panel concerns the super learner with categorized variables (super learner 1): mean squared error (MSE) associated with each candidate algorithm (*top figure*)—receiver operating curves (ROC) for each candidate algorithm (*bottom figure*); lower panel concerns the super learner with non-transformed variables (super learner 2): mean squared error (MSE) associated with each candidate algorithm (*top figure*)—receiver operating curves (ROC) for each candidate algorithm (*bottom figure*)

**Table 20.2** Reclassification tables

	Updated model				
	0-0.25	0.25-0.5	0.5-0.75	0.75-1	% Reclassified
<i>Super learner 1</i>					
Initial model: original SAPS II					
0-0.25	13,341	134	3	0	1 %
0.25-0.5	4529	723	50	0	86 %
0.5-0.75	2703	1090	174	2	96 %
0.75-1	444	705	473	137	92 %
<i>Super learner 2</i>					
Initial model: original SAPS II					
0-0.25	12,932	490	55	1	4 %
0.25-0.5	4062	1087	142	11	79 %
0.5-0.75	2531	1165	258	15	93 %
0.75-1	485	775	448	51	97 %
<i>Super learner 1</i>					
Initial model: new SAPS II					
0-0.25	20,104	884	30	2	4 %
0.25-0.5	894	1426	238	9	44 %
0.5-0.75	18	328	361	62	53 %
0.75-1	1	14	71	66	57 %
<i>Super learner 2</i>					
Initial model: new SAPS II					
0-0.25	19,221	1667	124	8	9 %
0.25-0.5	765	1478	318	6	42 %
0.5-0.75	24	346	367	32	52 %
0.75-1	0	26	94	32	79 %
<i>Super learner 1</i>					
Initial model: new APACHE II					
0-0.25	19,659	1140	107	6	6 %
0.25-0.5	1262	1195	296	34	57 %
0.5-0.75	89	298	264	71	63 %
0.75-1	7	19	33	28	68 %
<i>Super learner 2</i>					
Initial model: new APACHE II					
0-0.25	18,930	1764	200	18	9 %
0.25-0.5	1028	1395	345	19	50 %

(continued)



**Table 20.2** (continued)

	Updated model				
	0–0.25	0.25–0.5	0.5–0.75	0.75–1	% Reclassified
0.5–0.75	50	333	309	30	57 %
0.75–1	2	25	49	11	87 %

Super learner 1: super learner with categorized variables; super learner 2: super learner with non-transformed variables

significantly different from zero for both SL1 and SL2: cNRI = 0.336 (95 %CI: 0.298, 0.374),  $p < 0.0001$  and IDI = 0.029 (95 %CI: 0.023, 0.035),  $p < 0.0001$  for SL1; cNRI = 0.561 (95 %CI: 0.524, 0.598),  $p < 0.0001$  and IDI = 0.076 (95 %CI: 0.069, 0.082) for SL2. When compared either to the new SAPS II or the new APACHE II score, both Super Learner proposals resulted in a large proportion of patients reclassified, especially from high predicted probability strata to lower ones.

## 20.5 Discussion

The new scores based on the *Super Learner* improve the prediction of hospital mortality in this sample, both in terms of discrimination and calibration, as compared to the SAPS II or the APACHE II scoring systems. The Super Learner severity score based on untransformed variables, also referred to as SL2 or SICULA, is available online through a web application. An ancillary important result is that the MIMIC-II database can easily and reliably serve to develop new severity score for ICU patients.

Our results illustrate the crucial advantage of the Super Learner that can include as many candidate algorithms as inputted by investigators, including algorithms reflecting available scientific knowledge, and in fact borrows strength from diversity in its library. Indeed, established theory indicates that in large samples the *Super Learner* performs at least as well as the (unknown) optimal choice among the library of candidate algorithms [28]. This is illustrated by comparing the CV-MSE associated with each algorithm included in the library: SL1 achieves similar performance as BART, which is the best candidate in the case, while SL2 achieves similar performance as random forest, which outperformed all other candidates in this case. Hence, the *Super Learner* offers a more flexible alternative to other nonparametric methods.

Given the similarity in calibration of the two Super Learner-based scores (SL1 and SL2), we recommend using the Super Learner with untransformed explanatory variables (SL2) in view of its greater discrimination. When considering risk reclassification, the two Super Learner prediction algorithms had similar cNRI, but SL2 clearly had a better IDI. It should be emphasized that, when considering the IDI, the SL1 seemed to perform worse than the SAPS II score. Nonetheless, the IDI must be used carefully since it suffers from similar drawbacks as the AUROC: it

summarizes prediction characteristics uniformly over all possible classification thresholds even though many of these are unacceptable and would never be considered in practice [37].

## 20.6 What Are the Next Steps?

The SICULA should be compared to more recent severity scores. Nonetheless, such scores (e.g., SAPS 3 and APACHE III) have been reported to face the same drawbacks as SAPS II [9, 12, 38]. Moreover, those scores remain the most widely used scores in practice [39]. Despite the fact that MIMIC II encompasses data from multiple ICUs, the sample still comes from a single hospital and thus needs further external validation. However, the patients included in the MIMIC-II cohort seem representative of the overall ICU patient population, as reflected by a hospital mortality rate in the MIMIC-II cohort that is similar to the one reported for ICU patients during the same time period [40]. Consequently, our score can be reasonably expected to exhibit, in other samples, performance characteristics similar to those reported here, at least in samples drawn from similar patient populations. A large representation in our sample of CCU or CSRU patients, who often have lower severity scores than medical or surgical ICU patients, may have limited our score's applicability to more critically ill patients. Finally, a key assumption justifying this study was that the poor calibration associated with current severity scores derives from the use of insufficiently flexible statistical models rather than an inappropriate selection of variables included in the model. For this reason and for the sake of providing a fair comparison of our novel score with the SAPS II score, we included the same explanatory variables as used in SAPS II. Expanding the set of explanatory variables used could potentially result in a score with even better predictive performance. In the future, expanding the number of explanatory variables will probably further improve the predictive performances of the score.

## 20.7 Conclusions

Thanks to a large collection of potential predictors and a sufficient sample size, MIMIC II dataset offers a unique opportunity to develop and validate new severity scores. In this population, the prediction of hospital mortality based on the Super Learner achieves significantly improved performance, both in terms of calibration and discrimination, as compared to conventional severity scores. The SICULA prediction algorithm is a promising alternative that could prove valuable in clinical practice and for research purposes. Externally validating results of this study in different populations (especially population outside the U.S.), providing regular

update of the SICULA fit and assessing the potential benefit of including additional variables in the score remain important future challenges that are to be faced in the second stage of the SICULA project.

**Open Access** This chapter is distributed under the terms of the Creative Commons Attribution-NonCommercial 4.0 International License (<http://creativecommons.org/licenses/by-nc/4.0/>), which permits any noncommercial use, duplication, adaptation, distribution and reproduction in any medium or format, as long as you give appropriate credit to the original author(s) and the source, a link is provided to the Creative Commons license and any changes made are indicated.

The images or other third party material in this chapter are included in the work's Creative Commons license, unless indicated otherwise in the credit line; if such material is not included in the work's Creative Commons license and the respective action is not permitted by statutory regulation, users will need to obtain permission from the license holder to duplicate, adapt or reproduce the material.

## Code Appendix

This case study used code from the Super Learner Library, implemented in R. Further details and code are available from the GitHub repository accompanying this book: <https://github.com/MIT-LCP/critical-data-book>. The following algorithms are included in the Super Learner Library.

Parametric algorithms:

- Logistic regression: standard logistic regression, including only main terms for each covariate and including interaction terms [42] (SL.glm),
- Stepwise regression: logistic regression using a variable selection procedure based on the Akaike Information Criteria [43] (SL.stepAIC),
- Generalized additive model [43] (SL.gam);,
- Generalized linear model with penalized maximum likelihood [44] (SL.glmnet),
- Multivariate adaptive polynomial spline regression [44] (SL.polymars),
- Bayesian generalized linear model [45] (SL.bayesglm).

Non parametric algorithms:

- Random Forest [46] (SL.randomForest),
- Neural Networks [47] (SL.nnet),
- Bagging classification trees [48] (SL.ipredbagg),
- Generalized boosted regression model [49] (SL.gbm),
- Pruned Recursive Partitioning and Regression Trees [50] (SL.rpartPrune),
- Bayesian Additive Regression Trees [51] (SL.bart).

## References

1. Knaus WA, Zimmerman JE, Wagner DP, Draper EA, Lawrence DE (1981) APACHE-acute physiology and chronic health evaluation: a physiologically based classification system. *Crit Care Med* 9(8):591–597
2. Knaus WA, Draper EA, Wagner DP, Zimmerman JE (1985) APACHE II: a severity of disease classification system. *Crit Care Med* 13(10):818–829
3. Le Gall JR, Loirat P, Alperovitch A, Glaser P, Granthil C, Mathieu D, Mercier P, Thomas R, Villers D (1984) A simplified acute physiology score for ICU patients. *Crit Care Med* 12(11):975–977
4. Le Gall JR, Lemeshow S, Saulnier F (1993) A new simplified acute physiology score (SAPS II) based on a European/North American multicenter study. *JAMA* 270(24):2957–2963
5. Lemeshow S, Teres D, Klar J, Avrunin JS, Gehlbach SH, Rapoport J (1993) Mortality probability models (MPM II) based on an international cohort of intensive care unit patients. *JAMA* 270(20):2478–2486
6. Knaus WA, Wagner DP, Draper EA, Zimmerman JE, Bergner M, Bastos PG, Sirio CA, Murphy DJ, Lotring T, Damiano A (1991) The APACHE III prognostic system. Risk prediction of hospital mortality for critically ill hospitalized adults. *Chest* 100(6):1619–1636
7. Le Gall JR, Neumann A, Hemery F, Bleriot JP, Fulgencio JP, Garrigues B, Gouzes C, Lepage E, Moine P, Villers D (2005) Mortality prediction using SAPS II: an update for French intensive care units. *Crit Care* 9(6):R645–R652
8. Nassar AP, Jr, Mocelin AO, Nunes ALB, Giannini FP, Brauer L, Andrade FM, Dias CA (2012) Caution when using prognostic models: a prospective comparison of 3 recent prognostic models. *J Crit Care* 27(4), 423.e1–423.e7
9. Poole D, Rossi C, Latronico N, Rossi G, Finazzi S, Bertolini G (2012) Comparison between SAPS II and SAPS 3 in predicting hospital mortality in a cohort of 103 Italian ICUs. Is new always better? *Intensive Care Med* 38(8):1280–1288
10. Metnitz B, Schaden E, Moreno R, Le Gall J-R, Bauer P, Metnitz PGH (2009) Austrian validation and customization of the SAPS 3 admission score. *Intensive Care Med* 35(4):616–622
11. Moreno RP, Metnitz PGH, Almeida E, Jordan B, Bauer P, Campos RA, Iapichino G, Edbrooke D, Capuzzo M, Le Gall J-R (2005) SAPS 3—From evaluation of the patient to evaluation of the intensive care unit. Part 2: development of a prognostic model for hospital mortality at ICU admission. *Intensive Care Med* 31(10):1345–1355
12. Beck DH, Smith GB, Pappachan JV, Millar B (2003) External validation of the SAPS II, APACHE II and APACHE III prognostic models in South England: a multicentre study. *Intensive Care Med* 29(2):249–256
13. Aegerter P, Boumendil A, Retbi A, Minvielle E, Dervaux B, Guidet B (2005) SAPS II revisited. *Intensive Care Med* 31(3):416–423
14. Ledoux D, Canivet J-L, Preiser J-C, Lefrancq J, Damas P (2008) SAPS 3 admission score: an external validation in a general intensive care population. *Intensive Care Med* 34(10):1873–1877
15. Dybowski R, Weller P, Chang R, Gant V (1996) Prediction of outcome in critically ill patients using artificial neural network synthesised by genetic algorithm. *Lancet* 347(9009):1146–1150
16. Clermont G, Angus DC, DiRusso SM, Griffin M, Linde-Zwirble WT (2001) Predicting hospital mortality for patients in the intensive care unit: a comparison of artificial neural networks with logistic regression models. *Crit Care Med* 29(2):291–296
17. Ribas VJ, López JC, Ruiz-Sanmartin A, Ruiz-Rodríguez JC, Rello J, Wojdel A, Vellido A (2011) Severe sepsis mortality prediction with relevance vector machines. *Conf Proc IEEE Eng Med Biol Soc* 2011:100–103
18. Kim S, Kim W, Park RW (2011) A comparison of intensive care unit mortality prediction models through the use of data mining techniques. *Health Inform Res* 17(4):232–243

19. Foltran F, Berchialla P, Giunta F, Malacarne P, Merletti F, Gregori D (2010) Using VLAD scores to have a look insight ICU performance: towards a modelling of the errors. *J Eval Clin Pract* 16(5):968–975
20. Gortzis LG, Sakellariopoulos F, Ilias I, Stamoulis K, Dimopoulou I (2008) Predicting ICU survival: a meta-level approach. *BMC Health Serv Res* 8:157–164
21. Dudoit S, Van Der Laan MJ (2003) Asymptotics of cross-validated risk estimation in estimator selection and performance assessment. *Statistical Methodology* 2(2):131–154
22. Lee J, Scott DJ, Villarroel M, Clifford GD, Saeed M, Mark RG (2011) Open-access MIMIC-II database for intensive care research. *Conf Proc IEEE Eng Med Biol Soc* 2011:8315–8318
23. Saeed M, Villarroel M, Reisner AT, Clifford G, Lehman L-W, Moody G, Heldt T, Kyaw TH, Moody B, Mark RG (2011) Multiparameter intelligent monitoring in intensive care II: a public-access intensive care unit database. *Crit Care Med* 39(5):952–960
24. Goldberger AL, Amaral LA, Glass L, Hausdorff JM, Ivanov PC, Mark RG, Mietus JE, Moody GB, Peng CK, Stanley HE (2000) PhysioBank, PhysioToolkit, and PhysioNet: components of a new research resource for complex physiologic signals. *Circulation* 101(23):E215–E220
25. Pirracchio R, Petersen ML, Carone M, Rigon MR, Chevret S, van der Laan MJ (2015) Mortality prediction in intensive care units with the super ICU learner algorithm (SICULA): a population-based study. *Lancet Respir Med* 3(1)
26. Vincent JL, Moreno R, Takala J, Willatts S, De Mendonça A, Bruining H, Reinhart CK, Suter PM, Thijs LG (1996) The SOFA (Sepsis-related Organ Failure Assessment) score to describe organ dysfunction/failure. On behalf of the working group on sepsis-related problems of the European Society of Intensive Care Medicine. *Intensive Care Med* 22(7):707–710
27. Van Der Laan MJ, Dudoit S (2003) Unified cross-validation methodology for selection among estimators and a general cross-validated adaptive epsilon-net estimator: finite sample oracle inequalities and examples. U.C. Berkeley Division of Biostatistics Working Paper Series, Working Paper, no 130, pp 1–103
28. van der Laan MJ, Polley EC, Hubbard AE (2007) Super learner. *Stat Appl Genet Mol Biol* 6:25
29. Cox DR (1958) Two further applications of a model for binary regression. *Biometrika* 45(3/4):562–565
30. Harrison DA, Brady AR, Parry GJ, Carpenter JR, Rowan K (2006) Recalibration of risk prediction models in a large multicenter cohort of admissions to adult, general critical care units in the United Kingdom. *Crit Care Med* 34(5):1378–1388
31. Kramer AA, Zimmerman JE (2007) Assessing the calibration of mortality benchmarks in critical care: the Hosmer-Lemeshow test revisited. *Crit Care Med* 35(9):2052–2056
32. Bertolini G, D’Amico R, Nardi D, Tinazzi A, Apolone G (2000) One model, several results: the paradox of the Hosmer-Lemeshow goodness-of-fit test for the logistic regression model. *J Epidemiol Biostat* 5(4):251–253
33. Miller ME, Hui SL, Tierney WM (1991) Validation techniques for logistic regression models. *Stat Med* 10(8):1213–1226
34. Cook NR (2007) Use and misuse of the receiver operating characteristic curve in risk prediction. *Circulation* 115(7):928–935
35. Cook NR (2008) Statistical evaluation of prognostic versus diagnostic models: beyond the ROC curve. *Clin Chem* 54(1):17–23
36. Pencina MJ, D’Agostino RB, Sr, D’Agostino RB, Jr, Vasan RS (2008) Evaluating the added predictive ability of a new marker: from area under the ROC curve to reclassification and beyond. *Stat Med* 27(2):157–172; discussion 207–212, Jan 2008
37. Greenland S (2008) The need for reorientation toward cost-effective prediction: comments on ‘Evaluating the added predictive ability of a new marker: From area under the ROC curve to reclassification and beyond’ by M. J. Pencina et al., *Statistics in Medicine* 10.1002/sim.2929. *Stat Med* 27(2):199–206

38. Sakr Y, Krauss C, Amaral ACKB, Réa-Neto A, Specht M, Reinhart K, Marx G (2008) Comparison of the performance of SAPS II, SAPS 3, APACHE II, and their customized prognostic models in a surgical intensive care unit. *Br J Anaesth* 101(6):798–803
39. Rosenberg AL (2002) Recent innovations in intensive care unit risk-prediction models. *Curr Opin Crit Care* 8(4):321–330
40. Zimmerman JE, Kramer AA, Knaus WA (2013) Changes in hospital mortality for United States intensive care unit admissions from 1988 to 2012. *Crit Care* 17(2):R81
41. Van der Laan MJ, Rose S (2011) Targeted learning: causal inference for observational and experimental data. Springer, Berlin
42. McCullagh P, Nelder JA (1989) Generalized linear models, vol 37. Chapman & Hall/CRC
43. Venables WN, Ripley BD (2002) Modern applied statistics with S. Springer, Berlin
44. Friedman JH (1991) Multivariate adaptive regression splines. *Ann Stat* 1–67
45. Gelman A, Jakulin A, Pittau MG, Su YS (2008) A weakly informative default prior distribution for logistic and other regression models. *Ann Appl Stat* 1360–1383
46. Breiman L (2001) Random forests. *Mach Learn* 45(1):5–32
47. Ripley BD (2008) Pattern recognition and neural networks. Cambridge university press, Cambridge
48. Breiman L (1996) Bagging predictors. *Mach Learn* 24(2):123–140
49. Elith J, Leathwick JR, Hastie T (2008) A working guide to boosted regression trees. *J Anim Ecol* 77(4):802–813
50. Breiman L, Friedman J, Olshen R, Stone C (1984) Classification and regression trees. Chapman & Hall, New York
51. Chipman HA, George EI, McCulloch RE (2010) BART: Bayesian additive regression trees. *Ann Appl Stat* 4(1):266–298

# Chapter 21

## Mortality Prediction in the ICU

Joon Lee, Joel A. Dubin and David M. Maslove

### Learning Objectives

Build and evaluate mortality prediction models.

1. Learn how to extract predictor variables from MIMIC-II.
2. Learn how to build logistic regression, support vector machine, and decision tree models for mortality prediction.
3. Learn how to utilize adaptive boosting to improve the predictive performance of a weak learner.
4. Learn how to train and evaluate predictive models using cross-validation.

### 21.1 Introduction

Patients admitted to the ICU suffer from critical illness or injury and are at high risk of dying. ICU mortality rates differ widely depending on the underlying disease process, with death rates as low as 1 in 20 for patients admitted following elective surgery, and as high as 1 in 4 for patients with respiratory diseases [1]. The risk of death can be approximated by evaluating the severity of a patient's illness as determined by important physiologic, clinical, and demographic determinants.

In clinical practice, estimates of mortality risk can be useful in triage and resource allocation, in determining appropriate levels of care, and even in discussions with patients and their families around expected outcomes. Estimates of mortality risk are, however, based on studying aggregate data from large, heterogeneous groups of patients, and as such their validity in the context of any single patient encounter cannot be assured. This shortcoming can be mitigated by

personalized mortality risk estimation, which is well discussed in [2, 3], but is not a subject of the present study.

Perhaps even more noteworthy uses of mortality prediction in the ICU are in the areas of health research and administration, which often involve looking at cohorts of critically ill patients. Traditionally, such population-level studies have been more widely accepted as applications of mortality prediction given the cohort-based derivation of prediction models. In this context, mortality prediction is used to compare the average severity of illness between groups of critically ill patients (for example, between patients in different ICUs, hospitals, or health care systems) and between groups of patients enrolled in clinical trials. Predicted mortality can be compared with observed mortality rates for the purpose of benchmarking and performance evaluation of ICUs and health systems.

A number of severity of illness (SOI) scores have been introduced in the ICU to predict outcomes including death. These include the APACHE scores [4], the Simplified Acute Physiology Score (SAPS) [5], the Mortality Probability Model (MPM) [6], and the Sequential Organ Failure Assessment (SOFA) score [7]. These scoring systems perform well, with areas under the receiver operator characteristic (ROC) curves (AUROCs) typically between 0.8 and 0.9 [5, 6, 8]. Current research is exploring ways to leverage the enhanced completeness and expressivity of modern electronic medical records (EMRs) in order to improve prediction accuracy. In particular, the granular nature (i.e., a rich set of clinical variables recorded in high temporal resolution) of EMRs can lead to creating a personalized predictive model for a given patient by identifying and utilizing data from similar patients.

## 21.2 Study Dataset

This case study aimed to create mortality prediction models using the first ICU admissions from all adult patients in MIMIC-II version 2.6. In the *icustay\_detail* table, adult patients in MIMIC-II can be identified by *icustay\_age\_group*='adult', whereas the first ICU admission of each patient can be selected by *subject\_icustay\_seq*=1. In addition, all ICU stays with a null *icustay\_id* were excluded, since *icustay\_id* was used to find the data in other tables that correspond to the included ICU stays. A total of 24,581 ICU admissions in MIMIC-II met these inclusion criteria.

The following demographic/administrative variables were extracted to be used as predictors: age at ICU admission, gender, admission type (elective, urgent, emergency), and first ICU service type of the ICU admission. Furthermore, the first measurement in the ICU of the following vital signs and lab tests was each extracted as a predictor: heart rate, mean and systolic blood pressure (invasive and noninvasive measurements combined), body temperature, SpO<sub>2</sub>, respiratory rate, creatinine, potassium, sodium, chloride, bicarbonate, hematocrit, white blood cell count, glucose, magnesium, calcium, phosphorus, and lactate. Although the very



first measurements in the ICU were extracted, the exact measurement time with respect to the ICU admission time would have varied between patients. Also, this approach to variable-by-variable data extraction does not ensure concurrent measurements within patient. For the vast majority of the ICU admissions in MIMIC-II, however, measurements of these common clinical variables were obtained at the beginning of the ICU admission, or at most within the first 24 h.

As the patient outcome to be predicted, mortality at 30 days post-discharge from the hospital was extracted. In MIMIC-II, this binary outcome variable can be obtained by comparing the date of death (found in the *d\_patients* table) and the hospital discharge date (found in the *icustay\_detail* table). If our focus were on a greater time period to post-discharge death, we would have extracted mortality date in an attempt to predict survival time.

### 21.3 Pre-processing

Some of the extracted variables require further processing before they can be used for predictive modeling. In MIMIC-II, some ages are unrealistically large ( $\sim 200$  years), as they were intentionally inserted to mask the actual ages of those patients who were 90 years or older and still alive (according to the latest social security death index data), which is protected health information. For these patients, the median of such masked ages (namely, 91.4) was substituted. Furthermore, regarding ICU service type, FICU (Finard ICU; this is a term specific to Beth Israel Deaconess Medical Center where MIMIC-II data were collected) was converted to MICU (medical ICU) since there are only a small number of FICU admissions in MIMIC-II and FICU is nothing more than a special MICU.

There are abundant missing data in MIMIC-II. Although there are ways to make use of ICU admissions with incomplete data (e.g., imputation), this case study simply excluded cases with incomplete data since missing data is discussed in depth in [insert reference to Missing Data Chapter, Part 2]. After exclusion of cases with incomplete data, only 9269 ICU admissions remained. This still is a sufficient sample size to conduct the present case study, but approaches such as imputation and/or exclusion of variables with frequent missing data should be considered if a larger patient sample size is required.

With default settings in R, numeric variables are normally imported correctly with proper handling of missing data (flagged as NA), but special care may be needed for importing categorical variables. In order to avoid the empty field being imported as a category on its own, this case study (1) imported the categorical variables as strings, (2) converted all empty fields to NA, and then (3) converted the categorical variables to factors. This case study includes the following categorical variables: gender, admission type, ICU service type, and 30-day mortality.

## 21.4 Methods

The following predictive models were employed: logistic regression (LR), support vector machine (SVM), and decision tree (DT). These models were chosen due to their widespread use in machine learning. Although the reader should refer to appropriate chapters in Part 2 to learn more about these models, a brief description of each model is provided here.

LR is a model that can learn the mathematical relationship, within a restricted framework using a logistic function, between a set of covariates (i.e., predictor variables in this case study) and a binary outcome variable (i.e., mortality in this case study). Once this relationship is learned, the model can make a prediction for a new case given the predictor values from the new case. LR is very widely used in health research thanks to its easy interpretability.

SVMs are similar to LR in the sense that it can classify (or predict) a given case in terms of the outcome, but they do so by coming up with an optimal decision boundary in the data space where the dimensions are the covariates and all available data points are plotted. In other words, SVMs attempt to draw a decision boundary that puts as many negative (survived) cases as possible on one side of the boundary and as many positive (expired) cases as possible on the other side.

Lastly, DTs have a tree-like structure that consists of decision nodes in a hierarchy. Each decision node leads to two branches depending on the value of a particular covariate (e.g., age >65 or not). Each case follows appropriate branches until it reaches a terminal leaf node which is associated with a particular outcome. DT learning algorithms automatically learn an optimal decision tree structure given a set of data.

We also attempted to improve the predictive performance of the DT by applying adaptive boosting, i.e., AdaBoost [9]. AdaBoost can effectively improve a weak predictive model by building an ensemble of models that progressively focus more on the cases that are inaccurately predicted by the previous model. In other words, AdaBoost allowed us to build a series of DTs where the ones built later were experts on more challenging cases. In AdaBoost, the final prediction is the average of the predictions from the individual models.

In order to run the provided R code, the following R packages should be installed via `install.packages()`: *e1071*, *ada*, *rpart*, and *ROCR*. The training functions for LR, SVM, and DT are `glm()`, `svm()`, and `rpart()`, respectively. For all models, default parameter settings were used.

For training and testing, 10-fold cross-validation was utilized. Under such a scheme, the ICU admissions included in the case study were randomly partitioned into 10 similarly sized groups (a.k.a. folds). The procedure rotated through the 10 folds to train predictive models based on 9 folds (training data) and test them on the remaining fold (test data), until each fold is utilized as test data.

Predictive performance was measured using AUROC which is a widely used performance metric for binary classification. For each predictive model, the

AUROC was calculated for each fold of the cross-validation. In the provided R code, the `comp.auc()` function is called to calculate the AUROC given a set of predicted probabilities from a model and the corresponding actual mortality data.

## 21.5 Analysis

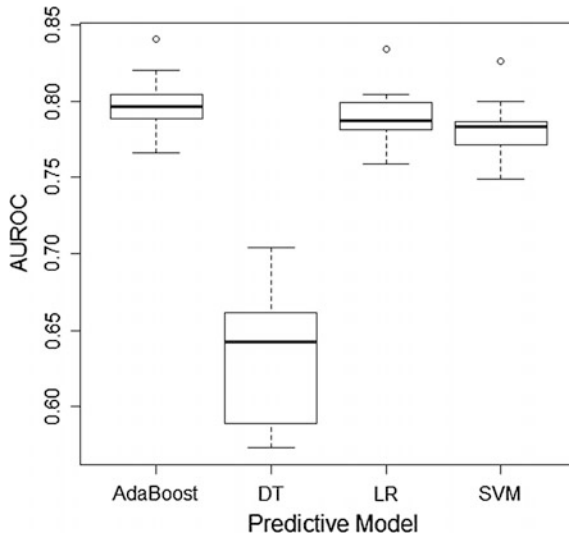
The following were the AUROCs of the predictive models (shown in mean [standard deviation]): LR—0.790 [0.015]; SVM—0.782 [0.014]; DT—0.616 [0.049]; AdaBoost—0.801 [0.013]. Hence, in terms of mean AUROC, AdaBoost resulted in the best performance, while DT was clearly the worst predictive model. DT was only moderately better than random guessing (which would correspond to an AUROC of 0.5) and as a result can be considered a weak learner. Note that AdaBoost was able to substantially improve DT, which is consistent with its known ability to effectively improve weak learners. Because of the random data partitioning of cross-validation, slightly different results will be produced every time the provided R code is run. Using `set.seed()` in R can seed the random number generation in `sample()` and make the results reproducible, but this was not used in this case study for a more robust evaluation of the results.

As a comparison, a previous study [2] reported mean AUROCs of 0.658 (95 % confidence interval (CI): [0.648,0.668]) and 0.633 (95 % CI: [0.624,0.642]) for SAPS I and SOFA, respectively, for predicting 30-day mortality for 17,152 adult ICU stays in MIMIC-II, despite that the analyzed patient cohort was a bit different from the one in this case study. More advanced SOI scores such as APACHE IV would have achieved a comparable or better performance than the predictive models investigated in this case study (only SAPS I and SOFA are available in MIMIC-II), but it should be noted that those advanced SOI scores tend to use a much more comprehensive set of predictors than the ones used in this case study.

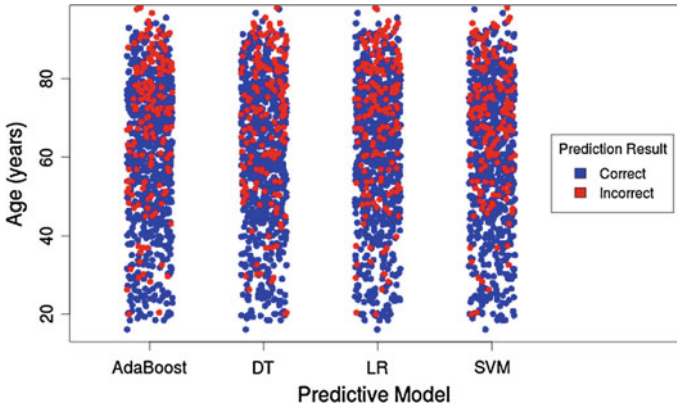
## 21.6 Visualization

Figure 21.1 shows the performances of the predictive models in a boxplot. It is visually apparent that AdaBoost, LR, and SVM resulted in similar performance, while DT yielded not only the worst performance but also the largest variability in AUROC, which sheds light on its sensitivity to the random data partitioning in cross-validation.

Figure 21.2 is an interesting visualization of the prediction results, where each circle represents a patient and the color of the circle indicates the prediction result (correct or incorrect) of the patient. Random horizontal jitter was added to each point (this simply means that a small random shift was applied to the x-value of each point) to reduce overlap with other points. Prediction results from only one of the ten cross-validation folds are shown, with a threshold of 0.5 (arbitrarily selected;



**Fig. 21.1** A box and whisker plot showing mortality prediction performances of several predictive models from 10-fold cross-validation. *AUROC* Area under the receiver operating characteristic curve; *DT* Decision tree; *LR* Logistic regression; *SVM* Support vector machine



**Fig. 21.2** Prediction results for individual patients as a function of age, stratified by predictive model. Results from only one of the ten cross-validation folds are plotted here

the reader may be interested in studying how this threshold affects this figure) applied to the estimated mortality risks from the predictive models (by calling the *th.pred()* function in the R code). Figure 21.2 shows the prediction results as a function of age, but the variable on the y-axis can easily be changed to some other variable of interest (e.g., heart rate, creatinine). One observation that is clear in Fig. 21.2 but not in Fig. 21.1 is that predictive accuracy is higher for younger

patients (e.g., <40 years) than for older patients, across all predictive models. This is most likely due to the fact that mortality rate is much lower among younger patients than older patients, and predictive models can achieve a high accuracy by biasing towards predicting low mortality risks (however, this would lead to a low sensitivity). Hence, it is important to note that although Fig. 21.2 conveys a sense of overall accuracy, it does not reveal sensitivity, specificity, positive predictive value, or negative predictive value.

## 21.7 Conclusions

Using clinical and demographic data from the MIMIC II database, this case study used machine learning algorithms to classify patients as alive or dead at 30 days after hospital discharge. Results were comparable to those obtained by the most up to date SOI scores currently in use. Unlike these scores, however, the learning algorithms used did not have access to specific diagnoses and procedures, which can add considerable predictive power. An advantage of using only clinical and demographic data, however, is that they are more routinely available and as a result predictive models based on them can be used more widely. Moreover, our algorithms were applied to an undifferentiated population of critically ill patients, rather than tailored to specific groups such as those following cardiovascular surgery (i.e., cardiac surgery recovery unit (CSRU) patients), which has also been shown to enhance predictive performance [3]. The success of prediction seen in this case study likely reflects the power of the learning algorithms used, as well as the utility of both the size and granularity of the database studied.

One useful prospect that leverages the dynamic nature of EMR data is the potential to update training data and prediction models as the most recent clinical data become available. This would theoretically lead to equally dynamic scoring systems that generate more accurate predictions by reflecting current practices. A trade-off becomes apparent between the use of the most current data, which is likely to be the most representative, and the inclusion of older data as well, which may be less relevant but provides greater statistical power.

## 21.8 Next Steps

Although AUROCs near 0.8 represent good performance, the fact that LR, SVM, and AdaBoost resulted in similar performance may imply that performance could be limited by the predictor variables rather than model selection. A meaningful future study could further investigate predictor selection or different representations of the same variables (e.g., temporal patterns rather than measurements at a specific time point; see the Hyperparameter Selection chapter of Part 3).

Since the default parameter settings were used for the LR, SVM, DT, and AdaBoost, another reasonable next step is to investigate how changing the parameters affect predictive performance. Please refer to R Help or appropriate R package documentation to learn more about the model parameters.

To improve predictive performance, we have previously considered a personalized mortality prediction approach where only the data from patients that are similar to an index patient (for whom prediction is to be made) are used for training customized predictive models [2]. Using a particular cosine-similarity-based patient similarity metric and LR, the maximum AUROC this study reported was 0.83. In light of this promising result, the reader is invited to pursue similar personalized approaches with new patient similarity metrics.

Bayesian methods [10] offer another prediction paradigm that may be worth investigating. Bayesian methods strike a balance between subject-matter expertise (for mortality prediction in the ICU, this would correspond to clinical expertise regarding mortality risk) and empirical evidence in the clinical data. Since the machine learning models discussed in this chapter were purely empirical, the explicit addition of clinical expertise through the Bayesian paradigm can potentially improve predictive performance.

Aside from AUROC, there are other ways to evaluate predictive performance, including the scaled Brier score. Please see [11] for more information. Once a threshold is applied to predicted mortality risk, more conventional performance measures such as accuracy, sensitivity, specificity, etc. can also be calculated. Since each performance measure has pros and cons (e.g., while AUROC provides a more complete assessment than simple accuracy, it becomes biased for skewed datasets [12]), it may be best to calculate a variety of measures for a holistic assessment of predictive performance.

Lastly, data quality is often overlooked but plays an important role in determining what predictive performance is possible with a given set of data. This is a particularly critical issue with retrospective EMR data, the recording of which may have had minimal data quality checks. Implementation of more rigorous data quality checks (e.g., outliers, physiologic feasibility) prior to predictive model training is a meaningful next step.

## 21.9 Connections

While this chapter focused on mortality prediction, the data extraction and analytic techniques discussed here are widely applicable to prediction of other discrete (e.g., hospital re-admission) and continuous (e.g., length of stay) patient outcomes. In addition, the nuances related to MIMIC-II such as handling ages near 200 years and the service type FICU are important issues for any MIMIC-II study.

The machine learning models (LR, DT, SVM) and techniques (cross-validation, AdaBoost, AUROC) are widely used in a variety of prediction, detection, and data

mining applications, not only in but beyond medicine. Furthermore, given that R is one of the most popular programming languages in data science, being able to manipulate EMR data and apply machine learning in R is an invaluable skill to have.

**Open Access** This chapter is distributed under the terms of the Creative Commons Attribution-NonCommercial 4.0 International License (<http://creativecommons.org/licenses/by-nc/4.0/>), which permits any noncommercial use, duplication, adaptation, distribution and reproduction in any medium or format, as long as you give appropriate credit to the original author(s) and the source, a link is provided to the Creative Commons license and any changes made are indicated.

The images or other third party material in this chapter are included in the work's Creative Commons license, unless indicated otherwise in the credit line; if such material is not included in the work's Creative Commons license and the respective action is not permitted by statutory regulation, users will need to obtain permission from the license holder to duplicate, adapt or reproduce the material.

## Code Appendix

The code used in this case study is available from the GitHub repository accompanying this book: <https://github.com/MIT-LCP/critical-data-book>. Further information on the code is available from this website. The reader can reproduce the present case study by running the following SQL and R codes verbatim:

- `query.sql`: used to extract data from the MIMIC II database.
- `analysis.R`: used to perform data processing.

## References

1. Kuzniewicz MW, Vasilevskis EE, Lane R, Dean ML, Trivedi NG, Rennie DJ, Clay T, Kotler PL, Dudley RA (2008) Variation in ICU risk-adjusted mortality: impact of methods of assessment and potential confounders. *Chest* 133(6):1319–1327
2. Lee J, Maslove DM, Dubin JA (2015) Personalized mortality prediction driven by electronic medical data and a patient similarity metric. *PLoS ONE* 10(5):e0127428
3. Lee J, Maslove DM (2015) Customization of a severity of illness score using local electronic medical record data. *J. Intensive Care Med*, 0885066615585951
4. Knaus WA, Draper EA, Wagner DP, Zimmerman JE (1985) APACHE II: a severity of disease classification system. *Crit Care Med* 13(10):818–829
5. Legall JR, Lemeshow S, Saulnier F (1993) A new simplified acute physiology score (SAPS-II) based on a european north-american multicenter study. *Jama-J Am Med Assoc* 270:2957–2963
6. Lemeshow S, Teres D, Klar J, Avrunin JS, Gehlbach SH, Rapoport J (1993) Mortality Probability Models (MPM II) based on an international cohort of intensive care unit patients. *JAMA* 270(20):2478–2486

7. Vincent J, Moreno R, Takala J, Willatts S, De Mendonca A, Bruining H, Reinhart C, Suter P, Thijs L (1996) The SOFA (sepsis-related organ failure assessment) score to describe organ dysfunction/failure. *Intensive Care Med* 22(7):707–710
8. Gursel G, Demirtas S (2006) Value of APACHE II, SOFA and CPIS scores in predicting prognosis in patients with ventilator-associated pneumonia. *Respiration*. 73(4):503–508
9. Freund Y, Schapire R (1995) A decision-theoretic generalization of on-line learning and an application to boosting. *Comput Learn Theory* 55(1):119–139
10. Gelman A, Carlin JB, Stern HS, Rubin DB (2014) *Bayesian data analysis*, vol 2. Taylor & Francis, UK
11. Wu YC, Lee WC (2014) Alternative performance measures for prediction models. *PLoS One* 9(3)
12. Davis J, Goadrich M (2006) The relationship between precision-recall and ROC curves. In: *Proceedings of the 23rd international conference on Machine learning—ICML'06*, pp 233–240



# Chapter 22

## Data Fusion Techniques for Early Warning of Clinical Deterioration

Peter H. Charlton, Marco Pimentel and Sharukh Lokhandwala

### Learning Objectives

Design and evaluate early warning score (EWS) algorithms which fuse vital signs with additional physiological parameters commonly available in hospital electronic health records (EHRs).

1. Extract physiological, demographic and biochemical variables from the MIMIC II database.
2. Extract patient outcomes from the MIMIC II database.
3. Prepare EHR data for analysis in Matlab<sup>®</sup>.
4. Design data fusion algorithms in Matlab<sup>®</sup>.
5. Compare the performances of data fusion algorithms.

### 22.1 Introduction

Acutely-ill hospitalized patients are at risk of clinical deteriorations such as infection, congestive heart failure and cardiac arrest [1]. The early detection and management of such deteriorations can improve patient outcomes, and reduce healthcare resource utilization [2, 3]. Currently, early warning scores (EWSs) are used to assist in the identification of deteriorating patients. EWSs were designed for use at the bedside: they can be calculated by hand, and the required inputs (vital signs) can be easily measured at the bedside. Now that EHRs are becoming more widespread in acute hospital care there is scope to develop improved EWSs by using more complex algorithms calculated by computer, and by incorporating additional physiological data from the EHR.

Most methods for detection of deteriorations are based on the assumption that changes in physiology are manifested during the early stages of deteriorations. This assumption is well documented. Schein et al. published landmark results in 1990

that 84 % of patients “had documented observations of clinical deterioration or new complaints” in the eight hours preceding cardiac arrest [4]. This was further supported by a study by Franklin et al. [5]. Physiological abnormalities have also been observed prior to other deteriorations such as unplanned Intensive Care Unit (ICU) admissions [6] and preventable deaths [7]. Evidence of deterioration can be observed 8–12 h before major events [8, 9].

It was proposed that the incidence of deteriorations could be reduced by recognising and responding to early changes in physiology [10–12]. Subsequently, EWSs were developed to allow timely recognition of patients at risk of deterioration. EWSs are aggregate scores calculated from a set of routinely and frequently measured physiological parameters, known as vital signs. The higher the score, the more abnormal the patient’s physiology, and the higher the risk of future deterioration. EWSs are now in widespread use in acute hospital wards [13].

Current EWSs correlate with important patient-centered endpoints such as levels of intervention [14], hospital mortality [14, 15], and length of stay [15], and have been shown to be a better predictor of cardiac arrest than individual parameters [16]. However, there is scope for improving their performance since most EWSs use simple formulae which can be calculated by hand at the bedside, and use only a limited set of vital signs as inputs [17]. Now that electronic health records (EHRs) are becoming widely used in acute hospital care, there is opportunity to use more complex, automated algorithms and a broader range of inputs. Consequently, algorithms have been proposed in the literature which improve performance by using data fusion techniques to combine vital signs with other parameters such as biochemistry and demographic data [18, 19].

The remainder of this chapter is designed to equip the reader with the necessary tools to develop and evaluate data fusion algorithms for prediction of clinical deteriorations.

## 22.2 Study Dataset

Data was extracted from the MIMIC II database (v. 2.26) [21], which is publicly available on PhysioNet [22]. This database was chosen because it contains routinely recorded EHR data for thousands of patients who, being critically-ill, are at high risk of deterioration. Data extraction was performed using the three SQL queries `cohort_labs.sql`, `cohort_vitals.sql`, and `cohort_selection.sql`. For ease of analysis data were extracted from only 500 patients. Only adult data were extracted since paediatrics have different normal physiological ranges to those of adults. The parameters extracted from the database, listed in Table 22.1, were chosen in line with those used previously in the literature [18, 19].

Traditionally the performance of EWSs has been assessed using three outcome measures with which rapid response systems have been assessed: mortality, cardiopulmonary arrest and ICU admission rates [20]. However, cardiopulmonary arrests are difficult to reliably identify in the MIMIC II dataset, and the dataset only

**Table 22.1** EHR Parameters extracted from the MIMIC II database records for input into data fusion algorithms

Biochemistry	Vital signs
Albumin	Respiratory rate
Anion gap	Heart rate
Arterial pCO <sub>2</sub>	Blood pressure—systolic and diastolic
Arterial pH	Temperature
Aspartate aminotransferase (AST)	Oxygen saturation
Bicarbonate	Level of consciousness
Blood urea nitrogen (BUN)	<b>Demographics</b>
Calcium	Age
Creatinine	Gender
Glucose	
Hemoglobin	
Platelets	
Potassium	
Sodium	
Total bilirubin	
White blood cell count (WBC)	

contains data from patients already staying on the ICU. Therefore, mortality, which can be reliably and easily extracted from the dataset, was chosen as the outcome measure for this case study.

### 22.3 Pre-processing

Data analysis was conducted in Matlab<sup>®</sup>. The first pre-processing step was to import the CSV files generated by the SQL query into Matlab<sup>®</sup> (using LoadData.m). The purpose of this step was to create:

1. A design matrix of predictor variables (the parameters listed in Table 22.1): This MxN matrix contained values for each of the N parameters at each of M time points. This was performed using the methodology in [19]: the time-points were calculated as the end times of successive four-hour periods spanning each patient’s ICU stay; parameter values at the time-points were set to the last measured value during that time period.
2. An Mx3 response matrix of the three easily acquired dependent variables, namely, binary variables of death in ICU and death in ICU within the next 24 h, and a continuous variable of time to ICU death.

The remaining pre-processing steps and analyses were conducted using only data from within these matrices.

Further pre-processing was required to prepare the data for analysis (PreProcessing.m). Firstly, it was observed that the temperature values exhibited a bimodal distribution centred on 37.1 and 98.8 °C, indicating that some had been measured in Celsius, and others in Fahrenheit. Those measured in

Fahrenheit were converted to Celcius. Secondly, the dataset contained blood pressures (BPs) acquired invasively and non-invasively. Invasive measurements were retained since they had been acquired more frequently. Non-invasive measurements were replaced with surrogate invasive values by correcting for the observed biases between the two measurement techniques when both had been used in the same four-hour periods (the median differences between invasive and non-invasive measurements were 2, 7 and 6 mmHg for systolic, diastolic and mean BPs respectively). Finally, the dataset contained missing values where parameters had not been measured within particular four-hour periods. These missing data had to be imputed since the analysis technique to be used, logistic regression, requires a complete data set. To do so, we followed the approach proposed previously of imputing the last measured value, unless no value had yet been measured in which case the population median value was imputed [19]. Note that this approach could be applied to a dataset in real-time.

## 22.4 Methods

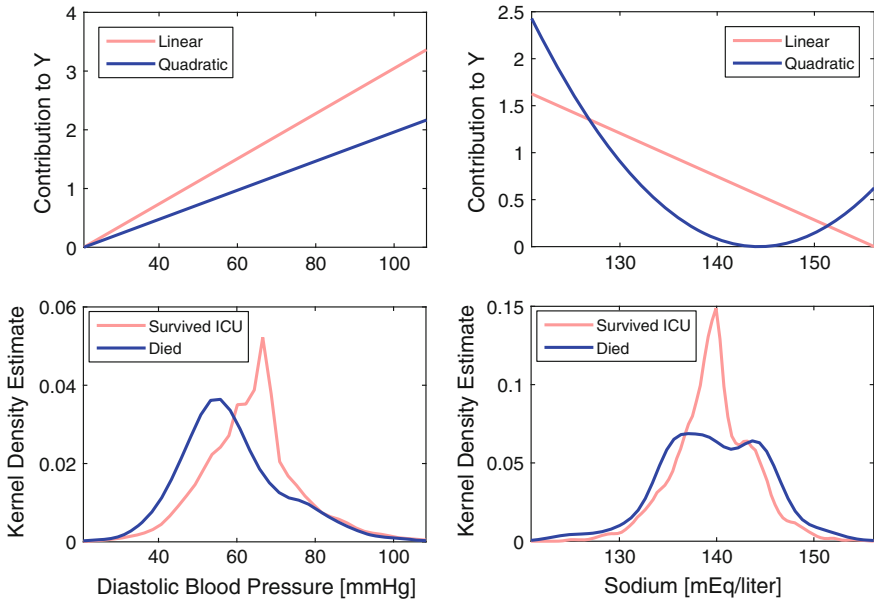
Novel data fusion algorithms were created using `CreateDataFusionAlgs.m`. Generalized linear models were used to fuse both continuous and binary variables to provide an output indicative of the patient’s risk of deterioration. A training dataset, containing 50 % of the data, was used to create the algorithms.

Logistic regression was used to estimate the probability of each of the binary response variables of “death in ICU”, and “death in ICU within 24 h” being true. Logistic regression differs from ordinary linear regression in that it bounds the output to be between 0 and 1, thus making it suitable for estimation of the probability of a response variable being true. Logistic regression provides an estimate for

$$y = \ln \left[ \frac{p(x)}{1 - p(x)} \right]$$

where  $p(x)$  is the probability of the response variable being true and  $x$  is a vector of predictor variables. Notice that  $p(x)$  is constrained to be between 0 and 1 for all real values of  $y$ .

When using logistic regression one must decide how to model the relationships between the  $n$  predictor variables contained within  $x$ , and the output,  $y$ . The simplest method is to assume that  $y$  is linearly related to the predictor variables as  $y = \alpha + \sum_{i=1}^n \beta_i x_i$ , where  $\alpha$  is the intercept term, and  $\beta$  is a vector of coefficients. For variables such as diastolic blood pressure the assumption of a linear relationship is reasonable because they consistently change in one particular direction during a deterioration. However, other variables such as sodium level could change in either



**Fig. 22.1** A comparison of the contributions of input variables to the algorithm output,  $Y$ , under the assumptions of either a linear or a non-linear relationship between the input variables and  $Y$ . The choice of relationship had little impact on the contribution of Diastolic Blood Pressure (*above left*), since it tended to be reduced in those patients who died (*below left*). However, a quadratic relationship provided a very different contribution for Sodium Level (*above right*), since the Sodium Levels of those patients who died exhibited a bimodal distribution indicating either an increase or a decrease away from the normal range (*below right*)

direction away from normality. For these variables a non-linear relationship is more appropriate, such as the quadratic

$$y = \alpha + \sum_{i=1}^n \beta_i x_i + \sum_{i=1}^n \gamma_i x_i^2,$$

where  $\gamma$  is a vector of coefficients for the squares of the predictor variables. Note that this ‘purely quadratic’ relationship does not contain interaction terms such as  $x_i x_j$ . The importance of the choice of relationship between the predictor variables and the estimate is demonstrated in Fig. 22.1.

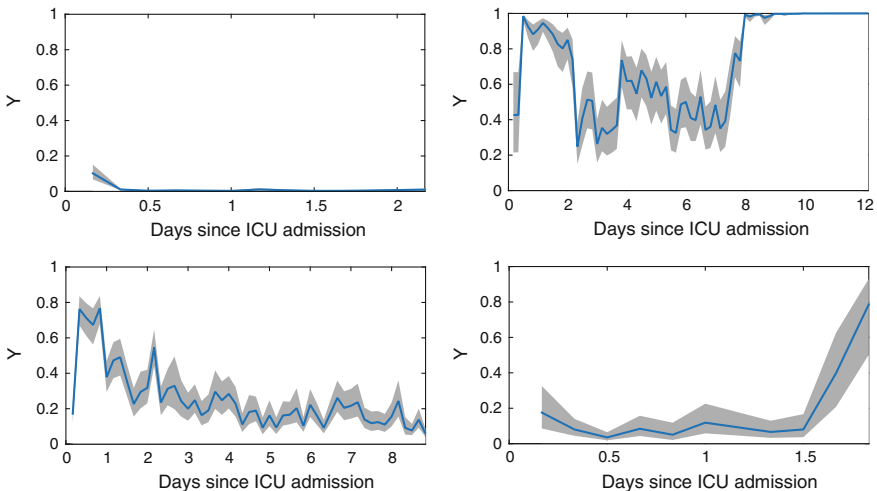
In this case study separate algorithms were created using linear and quadratic relationships. Firstly, only the parameters which are used in EWSs (vital signs) were included. Secondly, all the extracted EHR parameters were included. Thirdly, step-wise regression was used to avoid including terms which do not increase the performance of the model. This consisted of building a model by including terms until no further terms would increase the performance of the model, and then removing terms whose removal would not significantly decrease the performance of the model.

## 22.5 Analysis

EWS algorithms must trigger an effective clinical response in order to impact patient outcomes. Typically, a particular response is mandated when the algorithm's output is elevated above a threshold value. The response may include clinical review by ward staff or a centralised rapid response team. The following analysis is based on the assumption that the algorithms would be used to mandate responses such as this.

The performance of each algorithm was analysed using the latter 50 % of the data—the validation dataset. At all 4 h time points the model was used to estimate the probability of a patient dying during their ICU stay. Figure 22.2 shows exemplary plots of the output for four patients throughout their ICU stays. Throughout the analysis, each time point was classified as either positive or negative, indicating that the model predicted that the patient either subsequently died on ICU, or survived to ICU discharge. Hence, a true positive is identified at a particular time point when the model correctly predicts the death of a patient who died on ICU, whereas a false positive is identified when the model incorrectly predicts the death of a patient who survived to ICU discharge. True and false negatives were similarly identified.

Table 22.2 shows the performances of each algorithm assessed using the area under the receiver operating characteristic (ROC) curve (AUROC). The algorithm with the highest AUROC of 0.810 used stepwise inclusion of parameters and the quadratic relationship. The ROC curves for this algorithm and the corresponding algorithm using vital signs alone are shown in Fig. 22.3. Algorithms using all available parameters as inputs had higher AUROCs than those using vital signs

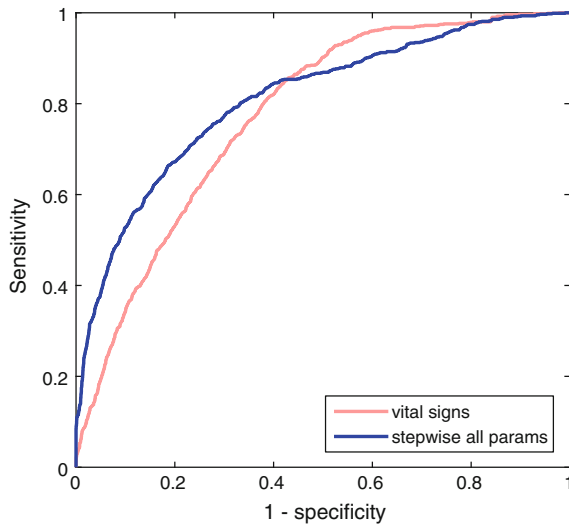


**Fig. 22.2** Exemplary plots of the output of algorithm outputs (Y) over the duration of patients' ICU stays. The *left hand* plots show patients who survived their ICU stays, whereas the *right hand* plots show patients who died. The *upper plots* show examples in which the algorithm performed well, whereas the *lower plots* show examples in which the algorithm did not perform well

**Table 22.2** The performances of data fusion algorithms for prediction of death in ICU, given as the area under the receiver-operator curve (AUROC), and the maximum sensitivities when the algorithms were constrained to satisfy the clinical requirements of a PPV  $\geq 0.33$ , and an alert rate of  $\leq 17\%$

Relationship between predictor variables and output	Candidate predictor variables	Number of predictor variables included	AUROC	Maximum Sensitivities [%]	
				PPV $\geq 0.33$	Alert rate $\leq 17\%$
Linear	Vital signs only	6	0.757	14.4	42.5
Linear	All	25	0.800	46.6	49.7
Linear	Stepwise inclusion of all	23	0.800	45.8	48.9
Purely quadratic	Vital signs only	6	0.774	13.2	41.4
Purely quadratic	All	25	0.799	55.5	53.9
Purely quadratic	Stepwise inclusion of all	21	0.810	59.3	56.3

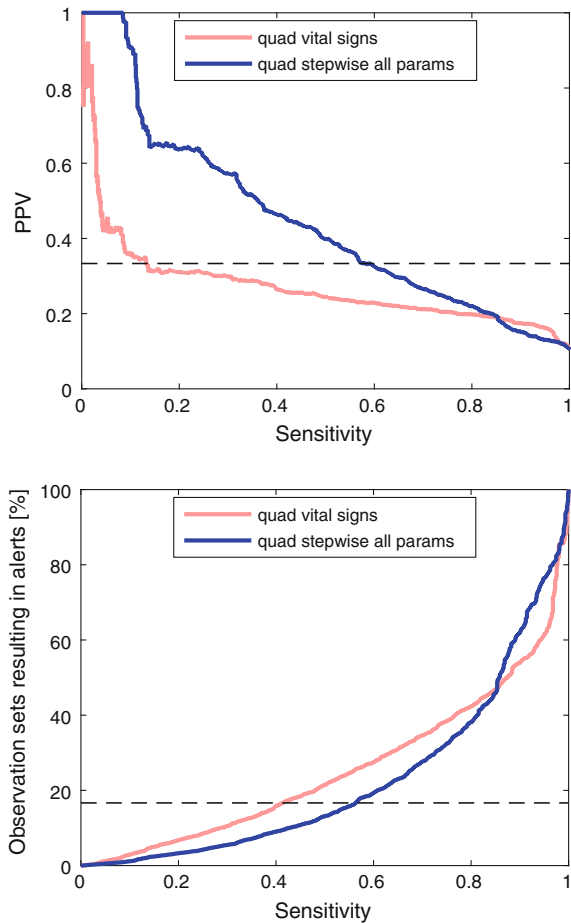
**Fig. 22.3** Receiver operating characteristic curves showing the performances of the best algorithms using stepwise inclusion of all parameters, and vital signs alone. These algorithms assumed a quadratic relationship between the predictor variables and the output



alone, demonstrating the benefit of fusing vital signs with additional parameters. In most instances the use of a quadratic relationship resulted in a higher AUROC. Furthermore, stepwise selection of parameters did reduce the number of parameters required, whilst maintaining or improving the AUROC.

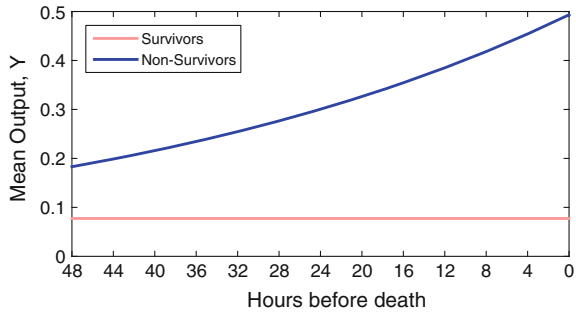
Other metrics for comparison of algorithms have been suggested including sensitivity, positive predictive value (PPV) and alert rate [23]. However, these are more difficult to use since each metric varies according to the threshold value. A useful method for comparing algorithms using these metrics is to compare their sensitivities when a threshold is used which provides algorithmic performance in line with clinical requirements. In the case of EWS algorithms, key clinical requirements are that the PPV is at or above a minimum acceptable level, and the alert rate is at or below a maximum acceptable level. In the absence of evidence-based values, for demonstration purposes we used a minimally acceptable PPV of 0.33, indicating that one in three alerts is a true positive, and a maximally acceptable alert rate of 17 %, indicating that one in six observation sets results in an alert. Table 22.2 shows the sensitivities provided by each algorithm when constrained to satisfy these clinical requirements. The PPVs and alert rates at all thresholds are shown in Fig. 22.4 for the best performing algorithms using vital

**Fig. 22.4** A comparison of the PPVs and alert rates for algorithms using vital signs alone and using all parameters. Exemplary clinical requirements of a  $PPV \geq 0.33$  and an alert rate  $\geq 17\%$  are shown by the dashed lines. The quadratic algorithm using vital signs alone has a much lower sensitivity of 13.2 % than the equivalent algorithm using stepwise inclusion of all parameters, at 59.3 % when the PPV criterion is met. Similarly, when the alert rate criterion is used, the sensitivity of the vital signs algorithm is 41.4 %, also lower than that of the algorithm using stepwise inclusion of all parameters, at 56.3 %

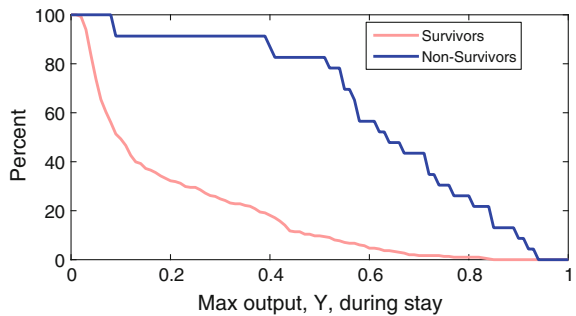




**Fig. 22.5** Mean algorithm outputs during the 48 h prior to death on ICU (after exponential smoothing). A lower choice of threshold for alerting results in more advanced warning of deterioration



**Fig. 22.6** The proportion of survivors and non-survivors who reached each algorithm output value during their ICU stay. A lower choice of threshold for alerting results in more false alerts, and fewer true alerts



signs alone and using stepwise inclusion of all parameters. The highest sensitivities were achieved when using stepwise inclusion of all parameters, with a purely quadratic relationship. The benefit of using additional parameters beyond vital signs is clearly shown by the algorithms’ sensitivities at the minimum acceptable PPV, which were 13.2 % when using vital signs alone, and 59.3 % when using stepwise inclusion of all parameters.

In [19] additional visualisations were used to demonstrate the effect of choosing different thresholds. Firstly, the dependent variable of time before death on ICU was used to examine how the output changed with time before death, as shown in Fig. 22.5. This shows that a lower threshold results in more advanced warning of deterioration. Secondly, the proportion of patients who reached each output during their stay was presented, as shown in Fig. 22.6. This suggests that a lower threshold results in more false alerts and fewer true alerts.

## 22.6 Discussion

The introduction of EHRs has provided opportunity to improve the clinical algorithms used to identify deteriorations. The data fusion algorithms described in this chapter estimate the probability of a patient dying during their ICU stay every 4 h.

The inclusion of additional physiological parameters beyond vital signs alone resulted in improvements in algorithm performance in this study when assessed using the AUROC, as also observed previously [18, 19], and when assessed using the minimum sensitivities corresponding to clinical requirements.

This case study has demonstrated the fundamental steps required to design and evaluate data fusion algorithms for prediction of deteriorations. During pre-processing the required data were extracted from the raw data files, and processed into matrices ready for analysis. It was important to perform this step separately to the analysis to reduce the time required for algorithm design. During this step we identified deficiencies in the dataset. Unfortunately, there is no systematic way to ensure that all deficiencies have been identified. We recommend that firstly the distributions of each variable are inspected to identify obvious discrepancies such as the different units used for temperature in this dataset. Secondly, it is helpful to plot the raw data over time to identify any changes in practice that may have occurred during data acquisition. Thirdly, it is often valuable to seek the guidance of a clinician or database curator at the host institution, or a researcher who has worked with the dataset before.

The results presented here cannot be generalised to a hospital-wide patient population for two reasons. Firstly, the dataset consists of data from critically-ill patients, whereas EWSs are primarily designed to identify deteriorations in acutely-ill patients. Since the disease processes of critically-ill patients are more advanced and they have additional clinical interventions such as mechanical ventilation and organ support, both the baseline physiology and the physiological changes accompanying deteriorations may differ in this population compared to acutely-ill patients. Secondly, death in ICU was used as the dependent variable in this study. Death is the latest possible stage of deterioration, and therefore an algorithm which predicts death may not predict the onset of deteriorations early enough to be of clinical utility in acutely-ill patients.

The choice of statistical methods to assess the performance of EWSs is the subject of debate [23]. The AUROC has often been used to quantify the performance of EWS algorithms, such as in [17]. This statistic is calculated from an algorithm's sensitivities and specificities at a range of threshold values. However, it has been recently suggested that the AUROC is misleading due to the low prevalence of deteriorations [23]. In [23] alternative statistical measures were proposed to account for the clinical requirements of EWS algorithms. Statistical measures should firstly assess the benefits and costs of using EWSs. The benefit is that EWSs can act as a safety net to catch deteriorating patients who have been missed in routine clinical assessments. This requires a high sensitivity (the proportion of EWS assessments of deteriorating patients which do alert). The cost of EWSs is the time taken to respond to false alerts. This cost is relatively small, since the additional clinical assessment triggered by an alert takes only a short amount of time. This means that a high specificity (the proportion of negative tests which are true negatives) is not of great importance. Secondly, it is important to ensure that the positive predictive value (the proportion of alerts which are true) is high enough to prevent caregivers suffering from desensitisation to alerts, which may result in less

effective responses to patients who are correctly identified as deteriorating [24]. Thirdly, the alert rate must be manageable to avoid excessive resource utilization. In this case study we presented the AUROC and the maximum sensitivities when algorithms were constrained to a minimally acceptable PPV and a maximally acceptable alert rate [23].

## 22.7 Conclusions

This case study has demonstrated the potential utility of data fusion techniques to predict clinical deteriorations. Currently identification of deteriorations is achieved using EWSs which take vital signs as inputs. The performance of the data fusion algorithms assessed in this study was improved by increasing the set of inputs to include physiological parameters which are routinely available in EHRs, but are not measured at the bedside.

The fundamental techniques for design and evaluation of data fusion algorithms have been demonstrated. Logistic regression algorithms were used to predict a binary response variable, death in ICU. The use of both linear and quadratic relationships between the predictor and response variables were demonstrated as well as the use of stepwise inclusion of variables. A range of statistical measures were presented for evaluation of algorithms, illustrating the benefits of using alternative statistical measures to the commonly used AUROC.

The results should not be interpreted as representative of the results that could be expected when EWSs are used in acute settings since the study dataset consists of critically-ill patients, and death in ICU was used as the dependent variable. However, the techniques used to design and evaluate algorithms can be easily applied to a wide range of patient settings, providing a basis for further work.

## 22.8 Further Work

Two particular areas have been identified for further research. Firstly, the work could be repeated using a dataset acquired from acutely-ill, rather than critically-ill patients, and by using a dependent variable other than death. This would facilitate design of algorithms that are generalisable to the target hospital population. Secondly, a range of additional functions could be explored to model the relationship between the predictor variables and the output. More complex functions than the linear or purely quadratic functions such as higher order polynomials or

logistic functions may improve performance. In addition it would be prudent to investigate the effect of the inclusion of interaction terms to account for the relationships between predictor variables.

## 22.9 Personalised Prediction of Deteriorations

The algorithms presented here are limited in scope by the input parameters. Currently they obtain a detailed description of a patient's physiological state from the vital signs and biochemistry values, which make up 23 out of the 25 inputs. However, these parameters provide very little differentiation between individual patients according to their state on admission to hospital. In contrast, additional information present upon hospital admission is used by clinicians during a patient's hospital stay to contextualise physiological assessments.

To illustrate this, consider the response of the algorithms to two fictional 65-year old males, patients A and B. Patient A has a history of hypertension, and a high systolic blood pressure (SBP) prior to hospital admission of 147 mmHg. Patient B has led an active life, has a healthy diet, and has a relatively low SBP prior to admission of 114 mmHg. During their hospital stay, the SBP of both patients is measured to be 114 mmHg. The algorithms cannot distinguish whether this is representative of patient A during a significant deterioration, such as the early stages of hypotension preceding septic shock, or whether it is representative of patient B's usual state in the absence of any deterioration. If the algorithms used a wider range of inputs indicative of patient state prior to admission, such as the presence or absence of co-morbidities (existing medical conditions) including hypertension, they might be able to differentiate between patients A and B in this situation.

This illustrates the potential benefit of incorporating additional inputs indicating co-morbidities. Even greater benefit may be derived by also personalising EWS algorithms according to physiological state prior to admission. Personalised EWS algorithms would not only stratify patients using additional inputs to contextualise physiology, but would also personalise the regression coefficients according to a patient's physiological state measured previously at a time of relative health.

**Open Access** This chapter is distributed under the terms of the Creative Commons Attribution-NonCommercial 4.0 International License (<http://creativecommons.org/licenses/by-nc/4.0/>), which permits any noncommercial use, duplication, adaptation, distribution and reproduction in any medium or format, as long as you give appropriate credit to the original author(s) and the source, a link is provided to the Creative Commons license and any changes made are indicated.

The images or other third party material in this chapter are included in the work's Creative Commons license, unless indicated otherwise in the credit line; if such material is not included in the work's Creative Commons license and the respective action is not permitted by statutory regulation, users will need to obtain permission from the license holder to duplicate, adapt or reproduce the material.

## Code Appendix

The code used in this case study is available from the GitHub repository accompanying this book: <https://github.com/MIT-LCP/critical-data-book>. Further information on the code is available from this website. The following key scripts were used to extract data from the MIMIC II database:

- `cohort_selection.sql`: used to identify a cohort of patients for whom data would be extracted.
- `cohort_labs.sql`: used to extract laboratory test results.
- `cohort_vitals.sql`: used to extract vital signs.

Data was extracted in CSV format. Subsequent analysis was performed in Matlab<sup>®</sup> using `RunFusionAnalysis.m`. It contains the following script:

- `SetupUniversalParams`: used to set universal parameters (in this case, file paths), which are used to load and save files throughout the analysis). These parameters should be adapted when using the code.

It then called the following scripts:

- `LoadData.m`: used to load CSV data into Matlab<sup>®</sup> for analysis.
- `PreProcessing.m`: performs pre-processing to prepare data for analysis.
- `CreateDataFusionAlgs.m`: creates data fusion algorithms using training data.
- `AnalysePerformances.m`: analyses the performances of data fusion algorithms using validation data.

## References

1. Silber JH et al (1995) Evaluation of the complication rate as a measure of quality of care in coronary artery bypass graft surgery. *JAMA* 274(4):317–323
2. Khan NA et al (2006) Association of postoperative complications with hospital costs and length of stay in a tertiary care center. *J Gen Intern Med* 21(2):177–180
3. Lagoe RJ et al (2011) Inpatient hospital complications and lengths of stay: a short report. *BMC Res Notes* 4(1):135
4. Schein RM et al (1990) Clinical antecedents to in-hospital cardiopulmonary arrest. *Chest* 98(6):1388–1392
5. Franklin C et al (1994) Developing strategies to prevent in-hospital cardiac arrest: analyzing responses of physicians and nurses in the hours before the event. *Crit Care Med* 22(2):244–247
6. Buist MD et al (1999) Recognising clinical instability in hospital patients before cardiac arrest or unplanned admission to intensive care. A pilot study in a tertiary-care hospital. *Med J Aust* 171(1):22–25
7. Hillman KM et al (2001) Antecedents to hospital deaths. *Intern Med J* 31(6):343–348
8. Hillman KM et al (2002) Duration of life-threatening antecedents prior to intensive care admission. *Intensive Care Med* 28(11):1629–1634

9. Whittington J et al (2007) Using an automated risk assessment report to identify patients at risk for clinical deterioration. *Jt Comm J Qual Patient Saf* 33(9):569–574
10. Smith AF et al (1998) Can some in-hospital cardio-respiratory arrests be prevented? A prospective survey. *Resuscitation* 37(3):133–137
11. Patient Safety Observatory (2007) Safer care for the acutely ill patient: learning from serious incidents. National Patient Safety Agency, London
12. Whittington J et al (2007) Using an automated risk assessment report to identify patients at risk for clinical deterioration. *Jt Comm J Qual Patient Saf* 33(9):569–574
13. Royal College of Physicians (2012) National early warning score (NEWS): standardising the assessment of acute-illness severity in the NHS”, Report of a working party. RCP, London
14. Goldhill DR et al (2005) A physiologically-based early warning score for ward patients: the association between score and outcome. *Anaesthesia* 60(6):547–553
15. Paterson R et al (2006) Prediction of in-hospital mortality and length of stay using an early warning scoring system: clinical audit. *Clin. Med.* 6(3):281–284
16. Churpek MM et al (2012) Predicting cardiac arrest on the wards: a nested case-control study. *Chest* 141(5):1170–1176
17. Smith GB et al (2013) The ability of the national early warning score (NEWS) to discriminate patients at risk of early cardiac arrest, unanticipated intensive care unit admission, and death. *Resuscitation* 84(4):465–470
18. Alvarez CA et al. (2013) Predicting out of intensive care unit cardiopulmonary arrest or death using electronic medical record data. *BMC Med Inform Decis Mak* 13(28)
19. Churpek MM et al (2014) Multicenter development and validation of a risk stratification tool for ward patients. *Am J Respir Crit Care Med* 190:649–655
20. Maharaj R et al (2015) Rapid response systems: a systematic review and meta-analysis. *Crit Care* 19(1):254
21. Saeed M et al (2011) Multiparameter intelligent monitoring in intensive care II: a public-access intensive care unit database. *Crit Care Med* 39(5):952–960
22. Goldberger AL et al (2000) PhysioBank, PhysioToolkit, and PhysioNet: components of a new research resource for complex physiologic signals. *Circulation* 101(23):E215–E220
23. Romero-Brufau S, Huddleston JM, Escobar GJ, Liebow M (2015) Why the C-statistic is not informative to evaluate early warning scores and what metrics to use. *Crit Care* 19(1):285
24. Cvach M (2012) Monitor alarm fatigue: an integrative review. *Biomed Instrum Technol* 46(4):268–277

# Chapter 23

## Comparative Effectiveness: Propensity Score Analysis

**Kenneth P. Chen and Ari Moskowitz**

### Learning Objectives

Understand the incentives and disadvantages of using propensity score analysis for statistical modeling and causal inference in EHR-based research.

This case study introduces concepts that should improve understanding of the following:

1. Be aware of different approaches for estimating propensity scores: parametric, non-parametric, and machine learning approaches; and understand the pros and cons of each.
2. Learn different ways of using propensity scores to adjust for pre-treatment conditions, and to assess the balance of pre-treatment conditions among different treatment groups.
3. Appreciate concepts underlying propensity score analysis with EHRs including stratification, matching, and inverse probability weighting (including straight weight, stabilized weight, and doubly robust weighted regression).

### 23.1 Incentives for Using Propensity Score Analysis

When conducting research with electronic health records (EHRs) or other big data sources, we have access to a large number of covariates [1]. These covariates include patient demographics, physical parameters (e.g., vitals signs and physical examinations), laboratory parameters, home medications, pre-morbid conditions, etc. All these covariates could be confounders when considering the association between an exposure and an outcome. We can use statistical modeling to account for the confounding effect of these covariates and establish an association between the exposure and the outcome of interest [2, 3]. Propensity score analysis is

particularly advantageous when dealing with a large number of covariates [1]. The remainder of this chapter assumes a basic understanding of statistics and regression modeling (especially logistic regression).

Adjusting for as many covariates as possible sets the ground for a convincing causal inference by reducing latent biases due to latent variates [4]. However, this results in increased dimension [5]. Although large scale EHRs often have large enough sample size to allow high-dimensional study, dimension reduction is still useful for the following reasons: (i) to simplify the final model and make interpretation easier, (ii) to allow sensitivity analyses to explore higher order terms or interaction terms for those covariates that might have correlation or interaction with the outcome, and (iii) depending on the research question, the study cohort might still be small despite coming from a large database, and dimension reduction therefore becomes crucial for a model to be valid.

## 23.2 Concerns for Using Propensity Score

Although propensity score analysis has the above mentioned advantages, it is important to understand the theory of propensity score analysis and appreciate its limitations. A propensity score is an ‘estimated probability’ of one subject being assigned to either the treatment group or the control group given the subject’s ‘characteristics’, or ‘pre-treatment conditions’. It is a surrogate for all the covariates that are used to estimate it. It is not hard to imagine that using a single propensity score to represent all characteristics of a subject could introduce bias [6]. Therefore, implementing propensity scores in a statistical analysis model has to take into account the research question, the dataset, and the covariates included in the analysis. Furthermore, results must always be validated with sensitive analyses [7].

## 23.3 Different Approaches for Estimating Propensity Scores

In a randomized controlled trial, a causal relationship between exposure (treatment) and outcome can be readily determined if the randomization is carried out properly, i.e. if there is no difference in pre-treatment conditions between the two groups. However, in retrospective studies a difference in pre-treatment conditions between the two groups almost always exists. In order to demonstrate comparative effectiveness, causal inference with statistical modeling can be carried out in a number of ways [8, 9]. For propensity score analyses [3, 10], the pre-treatment conditions can be used as predictors in determining the likelihood of a subject being in the treatment group or the control group. In other words, the probability of being in the



treatment or control group is a function of pre-treatment conditions. There are a number of ways to generate this function. The most basic one is regression.

When using regression to estimate propensity scores, the outcome of the regression equation is either treatment group or control group, i.e. a binary outcome, and the variables in the regression equation can be a combination of numeric and nominal variables. This is a multivariate logistic regression that can be easily performed using most free or commercial statistical packages. If there is more than one treatment group (e.g., treatment A, treatment B, and control group) [11], then the propensity score can be estimated using a multivariate multinomial logistic regression.

The conventional regression model is a parametric model. Consequently, the estimated propensity score will be subject to any inherent limitations of the parametric model, i.e. model misspecification [12]. It is possible to use a non-parametric model to estimate the propensity score [13], such as regression trees, piecewise approaches, and kernel distributions. However, these methodologies are less established and are likely to require the use of machine learning algorithms [14]. Although non-parametric methods often require machine learning algorithms, machine learning techniques can be applied to both parametric and non-parametric methods. For example, some studies use a genetic algorithm to select variables and model specification for a conventional logistic regression to estimate propensity score [15].

## 23.4 Using Propensity Score to Adjust for Pre-treatment Conditions

The goal of using propensity score analysis is to create a treatment group and a control group that are indistinguishable from each other in terms of the pre-treatment conditions statistics (e.g., means and standard deviations of numeric variables, distribution of nominal variables). In other words, a treatment group and a control group are created that mimic a post-randomization assignment result of a randomized controlled trial, so that a causal inference can be made. Propensity score analysis is one of the tools to reach this goal [8, 9, 16].

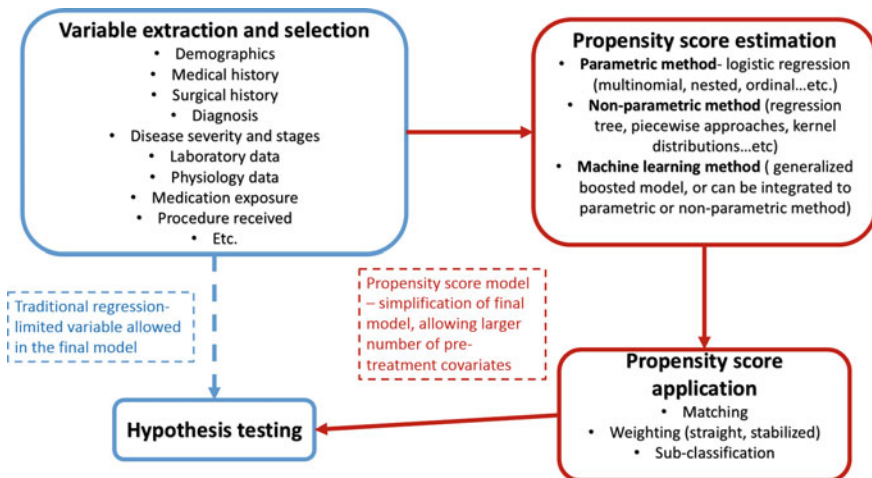
For example, consider one subject that received the study drug or treatment (treatment group) and one subject that received placebo or standard treatment (control group). If they have similar pre-treatment conditions then their chance (probability) of being in the treatment group is the same. Consequently, it is comparable to two identical subjects being randomly assigned to either treatment or control group. When we find two subjects that have similar propensity scores where one actually received treatment and the other actually received placebo, we ‘match’ them in our final study cohorts before we look at the treatment effect (outcome variable). This process is called “propensity score matching.” By doing this, we will

have similar propensity score distributions (or pre-treatment conditions distributions) between the treatment and control groups.

If the model used to estimate propensity scores is well-specified [17, 18], we would expect the propensity scores to be representative of subjects' pre-treatment conditions. However, this might not always be the case, so we always look at the group statistics after propensity score matching. Since the ultimate goal is to eliminate the difference in pre-treatment conditions between groups, other methods like propensity score weighting have been proposed to achieve this. More sophisticated machine learning algorithms have also been developed that look at the balance of pre-treatment variables between two groups during the process of estimating a propensity score to ensure a valid model in simulating a randomized controlled trial-like result [19].

In EHR data research, we have access to a large number of pre-treatment covariates that we can extract from the database and use in the propensity score model. Although we cannot use an indefinite number of covariates to simulate a real RCT (which accounts for all unobserved variables), we can gain greater confidence in our conclusion by including more variables [20, 21]. Propensity score analysis is a powerful tool to simplify the final model while allowing a large number of pre-treatment conditions to be included. Figure 23.1 summarizes the above discussion of applying a propensity score model.

We now present a case study that used the MIMIC II database (v.2.26) [22, 23], and focus on the application of propensity scores in the analytic phase. The study was a retrospective cohort study of Intensive Care Unit (ICU) patients who were treated with at least one rate control agent (metoprolol, amiodarone or diltiazem). Propensity score analysis was performed using the following covariates: demographics, vital signs, basic metabolic panels, past medical conditions, disease severity scores, types of admission, and types of ICU. The outcomes measured



**Fig. 23.1** Integration of propensity score analysis into a statistical design

were: (i) whether rate control was achieved by a single agent, or multiple agents (binary outcome); and, for those patients who reached rate control, (ii) the time to reach rate control (continuous outcome).

## 23.5 Study Pre-processing

In order to identify those patients with atrial fibrillation and rapid ventricular response (Afib with RVR) in the dataset, we used a combination of structured and unstructured data. Specifically, the structured data used included ICD-9 codes (the code for “Atrial Fibrillation” is 427.31) and medication administration data. The unstructured data used included waveform ECG data, serial heart rate (HR) data, discharge summaries and nursing notes. Unfortunately, only a small fraction of patients in the database have waveform data (approximately 2000 out of 32,000 patients). Consequently, we were unable to take full advantage of waveform analysis.

Patients who had Afib with RVR mentioned in their discharge summaries were identified by text searching equivalent keywords in discharge summaries while excluding the past medical history section. Once these patients had been identified we used the serial HR and medication administration data to find the subset of patients who had a HR of over 110 beats per minute (bpm) for more than 15 min and who received at least one of the rate control agents of interest (metoprolol, diltiazem, or amiodarone). Raw data was extracted using the Oracle® variety of SQL and was further processed using Python®, for text-searching discharge summaries, and Matlab®, for processing and plotting serial HR data and establishing temporal relationship between rapid ventricular response and medication administration.

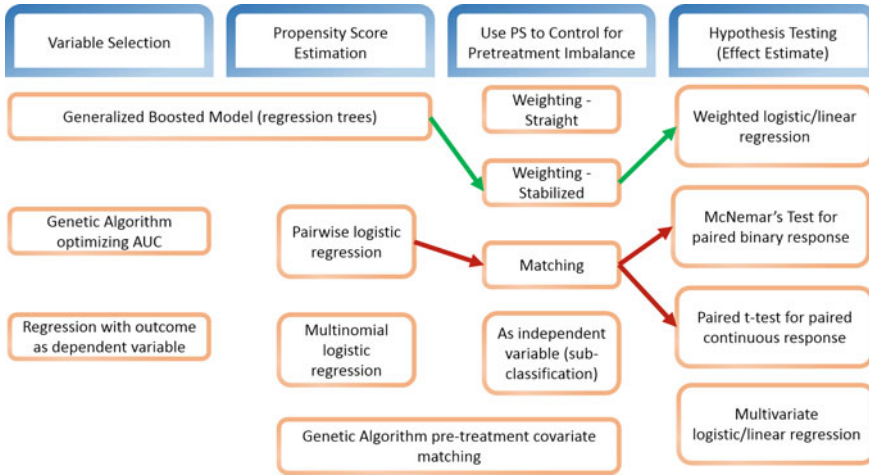
Serial HR data existed for almost every patient in the database. However, contrary to the continuous waveform ECG data, it is only recorded every 5, 10, or 15 min and inconsistently. To make the data more homogenous and easier for plotting and processing, we interpolated the HR every 5 min: during the patient’s ICU stay, if a raw HR data was not available for any given 5-min period, a value was interpolated using the two adjacent data points. Because of the infrequent sampling of HR for this data entity, one HR data point above 110 bpm would correspond to an episode of a rapid HR of 5-min duration. We arbitrarily chose a 15-min duration as a significant episode of rapid HR that warrants the algorithm (described below) to bring in more information from other data entity to determine if the tachycardic episode reflected Afib with RVR or another form of rapid rhythm (e.g. sinus tachycardia). This doesn’t mean that a patient has to have 15 min of Afib with RVR before the physician decides to treat in clinical practice. Instead, it is a measure to reduce the noise of solitary rapid HRs. One can experiment on implementing different cut-off values and then review the result to determine an appropriate threshold.

After identifying an episode of rapid HR which appeared to last for at least 15 min, we next determined whether the patient received a pharmacologic control agent of interest within 2 h before or after the identified episode. A 2-h window was used because medication data and HR data are two different data entities, and the time stamps they carried might not be aligned exactly. Furthermore, the time stamps associated with medication data might subject to inaccurate data entry by human loggers. This window was arbitrarily determined; a smaller window would have increase specificity but decreased the sensitivity of detecting the cohort of interest, and vice versa for a larger window.

A major criterion for determining the effectiveness of a pharmacologic agent in the control of Afib with RVR is the time until termination of the RVR episode. As this information is not explicitly contained in the database, one has to define when the rate is ‘controlled’ and then run an algorithm to find the time lapse between the onset and resolution of RVR. The half-life of intravenous metoprolol and diltiazem are each approximately 4 h and, therefore, we defined the resolution of RVR as achieving sustained HR below 110 bpm for 4 h. Although there is no consensus for the definition of RVR resolution, as long as the same definition is used for every subject or sub-cohort, there is a ground for comparison. Our algorithm finds every HR below 110 bpm after the previous identified Afib RVR (episodes of rapid HR that lasted for at least 15 min and were treated by at least one rate control agent) and tested if the ensuing HR data in the following 4 h was below 110 bpm for at least 90 % of the time. The time lapse between the onset and the resolution can then be calculated.

Covariates, including demographics, vital signs, basic metabolic panels, past medical conditions, disease severity scores, types of admission, and types of ICU, were extracted using SQL. We also looked into the patient’s home medication and past medical history of Afib. These pieces of information have to be extracted from the “home meds” and “past medical history” sections in the discharge summaries by using natural language processing techniques to text-search in a particular section of a discharge summary. Figure 23.2 is an example that our group used for discussing the analytic model.

Although we identified 1876 patients who were treated for Afib with RVR, only 320 of them received diltiazem as the first rate control agent. Using conventional regression analysis would result in over-fitting because of the small cohort size, and leaving out covariates would likely introduce biases. Propensity score analysis was used to reduce dimensionality. The first step is to estimate the propensity score (probability of being assigned to one treatment group given the pre-treatment covariates). As mentioned earlier, there are several different ways to estimate propensity scores including parametric methods such as multinomial logistic regression, and non-parametric methods such as prediction trees. Machine learning techniques can be implemented to train the propensity score model for optimized prediction. After the propensity score has been estimated, it can be used either as a variable in regression model to match subjects in different treatment groups with similar propensity scores, or to calculate inverse probability weights. When estimating propensity scores, besides optimizing the model to best predict the possible



**Fig. 23.2** Group discussions of the analytical model. The *green arrows* represent the final model, and the *red arrows* represent the model that was used as sensitivity analysis

treatment assignment given the pre-treatment variables, a newer concept is to estimate propensity scores to balance out pre-treatment covariates after matching or weighting. When using propensity score weighting, one can choose to use either straight weights or stabilized weights. Straight weighting is more susceptible to outliers with very distinct combination of pre-treatment covariates, and will double the cohort size when there are two treatment groups or triple the cohort size when there are three treatment groups. On the other hand, stabilized weighting is less susceptible to outliers, and does not increase the cohort size regardless of the number of treatment groups.

For this study we chose a machine learning algorithm (a generalized boosted model) to build a regression tree for the estimation of propensity scores (a non-parametric method). The reason for not choosing a parametric method is the same as that for not using a conventional regression analysis, as mentioned above. The model iteratively combines many simple regression trees until the pre-determined metrics for assessing between group pre-treatment covariate imbalance (standardized bias or Kolmogorov-Smirnov statistics) reach a minimum.

Extreme weights were eliminated using stabilized weights. Stabilized weights were then implemented in the final weighted regression for hypothesis testing. Depending on the nature of the outcome variable, weighted logistic regression is used for a binary outcome, and weighted liner regression is used for a continuous outcome. Several covariates with higher predictive power (of treatment assignment) were included in the final weighted regression model.

## 23.6 Study Analysis

In general, propensity score analysis has been used to compare two treatment groups, i.e. treatment versus control group. It is also commonly used for stratification (using propensity score as a covariate in a regression model) and propensity score matching (creating treatment and control groups of similar pre-treatment attribute and thus mimicking randomized trials). However, stratification can only establish association and propensity score matching mainly serves as a way of dimension reduction. Propensity score matching does carry the intention for causal inference, but matching propensity scores of three or more treatment groups requires calculating two or more dimensional distances for each matched group of subjects, which can be mathematically challenging and lacks supporting theory. Therefore, we chose machine-generated regression trees for our propensity score, and used a propensity score weighted regression model for outcome effect. The non-parametric approach avoided the limitations and biases introduced by model specification when using parametric methods. After the propensity score weight was generated, weighted regression was performed. This allows for exploration of interaction terms and adjustment for variables that have heavier effects on the outcomes that could not be fully eliminated by using propensity scores alone.

To validate our model, a series of sensitivity analyses using pair-wise propensity score matching were performed and similar effects of different treatment groups have on the outcomes were observed.

## 23.7 Study Results

In this single center retrospective cohort study, intravenous metoprolol was the most commonly used rate control agent for the control of Afib with RVR amongst patients in the intensive care unit. Using a novel propensity matching based approach, the effectiveness of metoprolol was compared to two other commonly used pharmacologic agents used for the control of Afib with RVR: diltiazem and amiodarone. With regards to the primary outcome of medication failure (defined as a switch to or addition of a second rate control agent), metoprolol had the lowest overall failure rate. Those patients who received diltiazem (odds ratio OR 1.55, confidence interval CI 1.05–2.3,  $p = 0.027$ ) or amiodarone (OR 1.50, CI 1.1–2.0,  $p = 0.006$ ) as their initial pharmacologic agent were more likely to receive an additional agent prior to the end of the RVR episode. In a secondary analysis of patients who received only one drug during their RVR episode, those who received diltiazem had significantly longer times to resolution of the RVR episode. Similarly, patients who received only diltiazem were also less likely to be controlled at 4 h than those who only received metoprolol (OR 0.59, CI 0.40–0.86,  $p = 0.007$ ).

These results suggest that critically ill patients with Afib with RVR are less likely to require a second pharmacologic agent and more likely to be controlled at

4 h if they receive metoprolol as their initial rate control agent then either diltiazem or amiodarone. This effect seems to be most pronounced when comparing metoprolol to diltiazem.

## 23.8 Conclusions

While it is widely accepted that Afib with RVR in the ICU is associated with worse outcomes overall, there is no clear consensus with regards to optimal pharmacologic management and practice varies amongst clinicians. Through the use of a three-way propensity matching model, we have compared the most commonly used pharmacologic agents for this phenomenon and found evidence that starting with metoprolol may lead to fewer treatment failures and a more rapid resolution of the RVR episode.

Propensity score theory is more commonly implemented on two-treatment group studies. Estimating propensity score in multiple-treatment group studies and implementing that in causal inference can be statistically and mathematically challenging. In this chapter, we provided an example of multiple-treatment group propensity score analysis using machine-learning algorithm. The concepts explored in this chapter can be easily implemented in any two-treatment group studies. We also provided an example of two treatment group propensity score analysis in the sensitivity analyses of our study by performing pair-wise comparison between different treatment groups. Propensity score analysis can be a powerful way to achieve causal inference and dimension reduction in studies utilizing EHRs.

## 23.9 Next Steps

The data analysis strategy employed in this project may be particularly helpful in answering a range of research questions in the ICU setting. Critical care clinicians frequently have to select from a range of interventions or pharmacologic agents. As opposed to traditional propensity matching approaches where only two groups are compared, this model allows for the simultaneous comparison of three independent groups. Examples where this analysis approach could be useful include comparing the effectiveness of different vasopressors in the treatment of shock or different sedative agents for intubated patients with ARDS.

Given the degree of clinical equipoise with regards to the treatment of Afib with RVR in the ICU, the above results are powerful in providing some direction to clinicians faced with this complex clinical problem. Still, many questions remain. It is not clear, for instance, whether higher doses of diltiazem may have been more effective and thereby avoided relatively increased rates of treatment failure. We did not look at doses provided in this study. We also did not explore the oral versus intravenous versus combined routes of administration. Atrial fibrillation during

critical illness is a common phenomenon whose management requires further investigation.

**Open Access** This chapter is distributed under the terms of the Creative Commons Attribution-NonCommercial 4.0 International License (<http://creativecommons.org/licenses/by-nc/4.0/>), which permits any noncommercial use, duplication, adaptation, distribution and reproduction in any medium or format, as long as you give appropriate credit to the original author(s) and the source, a link is provided to the Creative Commons license and any changes made are indicated.

The images or other third party material in this chapter are included in the work's Creative Commons license, unless indicated otherwise in the credit line; if such material is not included in the work's Creative Commons license and the respective action is not permitted by statutory regulation, users will need to obtain permission from the license holder to duplicate, adapt or reproduce the material.

## Code Appendix

The code used in this case study is available from the GitHub repository accompanying this book: <https://github.com/MIT-LCP/critical-data-book>. Further information on the code is available from this website. The following key scripts were used:

- `database_query.sql`: used to extract data from the MIMIC II database.
- `data_extraction.m`: used to extract variables for analysis.
- `propensity_score_analysis.r`: used for propensity score analysis.
- `propensity_score_matching.r`: used for propensity score matching.

## References

1. Patorno E et al (2014) Studies with many covariates and few outcomes: selecting covariates and implementing propensity-score-based confounding adjustments. *Epidemiology* 25 (2):268–278
2. Fitzmaurice G (2006) Confounding: propensity score adjustment. *Nutrition* 22(11–12):1214–1216
3. Austin PC (2011) An introduction to propensity score methods for reducing the effects of confounding in observational studies. *Multivariate Behav Res* 46(3):399–424
4. Li L et al (2011) Propensity score-based sensitivity analysis method for uncontrolled confounding. *Am J Epidemiol* 174(3):345–353
5. Toh S, Garcia Rodriguez LA, Hernan MA (2011) Confounding adjustment via a semi-automated high-dimensional propensity score algorithm: an application to electronic medical records. *Pharmacoepidemiol Drug Saf* 20(8):849–857
6. Guertin JR et al (2015) Propensity score matching does not always remove confounding within an economic evaluation based on a non-randomized study. *Value Health* 18(7):A338
7. Girman CJ et al (2014) Assessing the impact of propensity score estimation and implementation on covariate balance and confounding control within and across important subgroups in comparative effectiveness research. *Med Care* 52(3):280–287



8. Glass TA et al (2013) Causal inference in public health. *Annu Rev Public Health* 34:61–75
9. Cousens S et al (2011) Alternatives to randomisation in the evaluation of public-health interventions: statistical analysis and causal inference. *J Epidemiol Community Health* 65 (7):576–581
10. Brookhart MA et al (2013) Propensity score methods for confounding control in nonexperimental research. *Circ Cardiovasc Qual Outcomes* 6(5):604–611
11. Feng P et al (2012) Generalized propensity score for estimating the average treatment effect of multiple treatments. *Stat Med* 31(7):681–697
12. Rosthøj S, Keiding N (2004) Explained variation and predictive accuracy in general parametric statistical models: the role of model misspecification. *Lifetime Data Anal* 10 (4):461–472
13. Ertefaie A, Asgharian M, Stephens D (2014) Propensity score estimation in the presence of length-biased sampling: a nonparametric adjustment approach. *Stat* 3(1):83–94
14. Yoo C, Ramirez L, Liuzzi J (2014) Big data analysis using modern statistical and machine learning methods in medicine. *Int Neurourol J* 18(2):50–57
15. Hsu DJ et al (2015) The association between indwelling arterial catheters and mortality in hemodynamically stable patients with respiratory failure: a propensity score analysis. *Chest* 148(6):1470–1476
16. Hernan MA (2012) Beyond exchangeability: the other conditions for causal inference in medical research. *Stat Methods Med Res* 21(1):3–5
17. Austin PC, Stuart EA (2014) The performance of inverse probability of treatment weighting and full matching on the propensity score in the presence of model misspecification when estimating the effect of treatment on survival outcomes. *Stat Methods Med Res*
18. Pirracchio R, Petersen ML, van der Laan M (2015) Improving propensity score estimators' robustness to model misspecification using super learner. *Am J Epidemiol* 181(2):108–119
19. Lee BK, Lessler J, Stuart EA (2010) Improving propensity score weighting using machine learning. *Stat Med* 29(3):337–346
20. Brookhart MA et al (2006) Variable selection for propensity score models. *Am J Epidemiol* 163(12):1149–1156
21. Zhu Y et al (2015) Variable selection for propensity score estimation via balancing covariates. *Epidemiology* 26(2):e14–e15
22. Saeed M et al (2011) Multiparameter intelligent monitoring in intensive care II: a public-access intensive care unit database. *Crit Care Med* 39(5):952–960
23. Goldberger AL et al (2000) PhysioBank, PhysioToolkit, and PhysioNet: components of a new research resource for complex physiologic signals. *Circulation* 101(23):E215–E220

# Chapter 24

## Markov Models and Cost Effectiveness Analysis: Applications in Medical Research

Matthieu Komorowski and Jesse Raffa

### Learning Objectives

Understand how Markov models can be used to analyze medical decisions and perform cost-effectiveness analysis.

This case study introduces concepts that should improve understanding of the following:

1. Markov models and their use in medical research.
2. Basics of health economics.
3. Replicating the results of a large prospective randomized controlled trial using a Markov Chain and Monte Carlo simulations, and
4. Relating quality-adjusted life years (QALYs) and cost of interventions to each state of a Markov Chain, in order to conduct a simple cost-effectiveness analysis.

### 24.1 Introduction

Markov models were initially theroreticized at the beginning of the 20th century by Russian mathematician Andrey Markov [1]. They are stochastic processes that undergo transitions from one state to another. Over the years, they have found countless applications, especially for modeling processes and informing decision making, in the fields of physics, queuing theory, finance, social sciences, statistics and of course medicine. Markov models are useful to model environments and **problems involving sequential, stochastic decisions over time**. Representing such environments with decision trees would be confusing or intractable, if at all possible, and would require major simplifying assumptions [2]. Markov models can be examined by an array of tools including linear algebra (brute force), cohort simulations, Monte Carlo simulations and, for Markov Decision Processes, dynamic programming and reinforcement learning [3, 4].

A fundamental property of all Markov models is their **memorylessness**. They satisfy a first-order **Markov property** if the probability to move a new state to  $s_{t+1}$  only depends on the current state  $s_t$ , and not on any previous state, where  $t$  is the current time. Said otherwise, given the present state, the future and past states are independent. Formally, a stochastic process has the first order Markov property if the conditional probability distribution of future states of the process (conditional on both past and present values) depends only upon the present state:

$$P(s_{t+1}|s_1, s_2, \dots, s_t) = P(s_{t+1}|s_t)$$

This chapter will provide a brief introduction to the most common Markov models, and outline some potential applications in medical research and health economics. The last section will discuss a practical example inspired from the medical literature, in which a Markov chain will be used to conduct the cost-effectiveness analysis of a particular medical intervention. In general, the crude results of a study are unable to provide the necessary information to fully implement cost-effectiveness analysis, thus demonstrating the value of expressing the problem as a Markov Chain.

## 24.2 Formalization of Common Markov Models

The four most common Markov models are shown in Table 24.1. They can be classified into two categories depending or not whether the entire sequential state is observable [5]. Additionally, in Markov Decision Processes, the transitions between states are under the command of a control system called the agent, which selects actions that may lead to a particular subsequent state. By contrast, in Markov chains and hidden Markov models, the transition between states is autonomous. All Markov models can be finite (discrete) or continuous, depending on the definition of their state space.

### 24.2.1 The Markov Chain

The discrete time Markov chain, defined by the tuple  $\{S, T\}$  is the simplest Markov model, where  $S$  is a finite set of states and  $T$  is a state transition probability matrix,

**Table 24.1** Classification of Markov models

	Fully observable system	Partially observable systems
Autonomous system	Markov chain (MC)	Hidden Markov model (HMM)
System containing a control process	Markov decision process (MDP)	Partially observable Markov decision process (POMDP)



**Fig. 24.1** Example of a Markov chain, defined by a set  $S$  of finite states {Healthy, Ill} and a transition matrix, containing the probabilities to move from current state  $s$  to next state  $s'$  at each iteration

**Table 24.2** Example of a transition matrix corresponding to Fig. 24.1

		Next state $s$		Total
		Healthy	Ill	
Initial state $s$	Healthy	0.9	0.1	1
	Ill	0.5	0.5	1

$T(s', s) = P(s_{t+1} = s' | s_t = s)$ . A Markov chain can be **ergodic**, if it is possible to go from any state to every other state in finitely many moves. Figure 24.1 shows a simple example of a Markov Chain.

In the transition matrix, the entries in each column are between 0 and 1 (inclusive) and their sum is 1. Such vectors are called **probability vectors**. The Table 24.2 shows the transition matrix corresponding to Fig. 24.1. A state is said to be **absorbing** if it is impossible to leave it (e.g. death).

### 24.2.2 Exploring Markov Chains with Monte Carlo Simulations

Monte Carlo (MC) simulations are a useful technique to explore and understand phenomena and systems modeled under a Markov model. MC simulation generates pseudorandom variables on a computer in order to approximate difficult to estimate quantities. It has wide use in numerous fields and applications [6]. Our focus is on the MC simulation of a Markov chain, and it is straightforward once a transition probability matrix,  $T(s', s)$ , and final time  $t^*$  have been defined. We will assume at the index time ( $t = 0$ ), the state is known, and call it  $s_0$ . At  $t = 1$ , we simulate a categorical random variable using the  $s_0$ th row of the transition probability matrix  $T(s', s)$ . We repeat this  $t = 1, 2, \dots, t^* - 1, t^*$  to simulate *one simulated instance* of the Markov chain we are studying. One simulated instance only tells us about one possible sequence of transitions out of very many for this Markov chain, and we need to repeat this many ( $N$ ) times, recording the sequence of states for each of the simulated instances. Repeating this process many times, allows us to estimate quantities such as: the probability at  $t = 5$ , that the chain is in state 1; the average

proportion of time spent in state 1 over the first 10 time points; or the average length of the longest consecutive streak in state 1 in the first  $t^*$  time points.

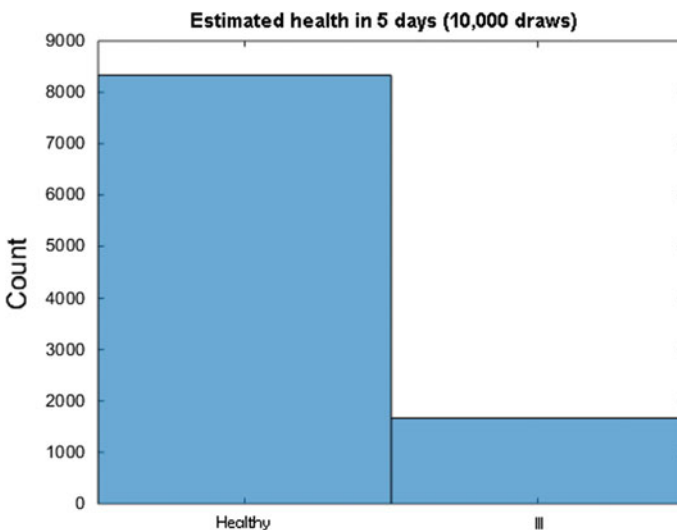
Using the example shown in Fig. 24.1, we will estimate the probability for someone to be healthy or ill in 5 days, knowing that he is healthy today. MC methods will simulate a large number of samples (say 10,000), starting in  $s_0 = \text{Healthy}$  and following the transition matrix  $T(s', s)$  for 5 steps, sequentially picking transitions to  $s'$  according to their probability. The output variable (the value of the final state) is recorded for each sample, and we conclude by analyzing the characteristics of the distribution of this output variable (Table 24.3).

The distribution of the final state at day + 5 for 10,000 simulated instances is represented on Fig. 24.2.

Table 24.4 reports some sample characteristics for “healthy” state on day 5 for 100 and 10,000 simulated instances, which illustrates why it is important to simulate a very large number of samples.

**Table 24.3** Example of health forecasting using Monte Carlo simulation

	Instance 1	Instance 2	...	Instance 10,000
Today	Healthy	Healthy	...	Healthy
Day + 1	Healthy	Healthy		Healthy
Day + 2	Healthy	Ill		Healthy
Day + 3	Healthy	Ill		Ill
Day + 4	Healthy	Ill		Healthy
Day + 5	Healthy	Ill	...	Healthy



**Fig. 24.2** Distribution of the health on day 5, for 10,000 instances

**Table 24.4** Sample characteristics for 100 and 10,000 simulated instances

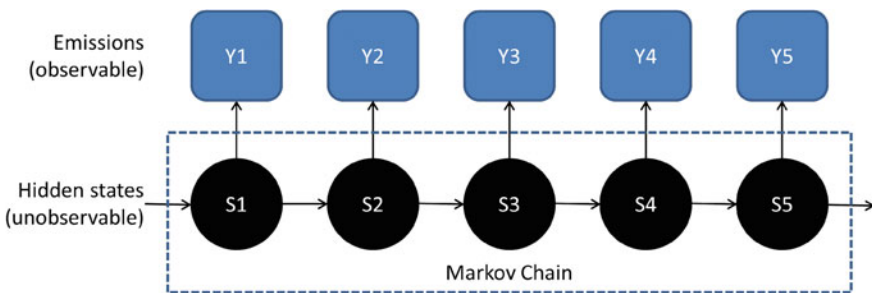
	100 simulated instances	10,000 simulated instances
Mean	0.81	0.83
Standard deviation	0.39	0.37
95 % confidence interval for the mean	0.73–0.89	0.83–0.84

By increasing the number of simulated instances, we drastically increase our confidence that the true sample mean falls within a very narrow window (0.83–0.84 in this example). The true mean calculated analytically is 0.838, which is very close to the estimate generated from MC simulation.

### 24.2.3 Markov Decision Process and Hidden Markov Models

Markov Decision Processes (MDPs) provide a framework for running reinforcement learning methods. MDPs are an extension of Markov chains, which include a control process. MDPs are a powerful and appropriate technique for modeling medical decision [3]. MDPs are most useful in classes of problems involving **complex, stochastic and dynamic decisions like medical treatment decisions**, for which they can find optimal solutions [3]. Physicians will always need to make subjective judgments about treatment strategies, but mathematical decision models can provide insight into the nature of optimal choices and guide treatment decisions.

In Hidden Markov models (HMMs), the state space is only partially observable [7]. It is formed by two dependent stochastic processes (Fig. 24.3). The first is a classical Markov chain, whose states are not directly observable externally, therefore “hidden.” The second stochastic process generates observable emissions, conditional on the hidden process. Methodology has been developed to decode the hidden states from the observed data and has applications in a multitude of areas [7].



**Fig. 24.3** Example of a hidden Markov model (HMM)

### 24.2.4 *Medical Applications of Markov Models*

MDPs have been praised by authors as being a powerful and appropriate approach for modeling sequences of medical decisions [3]. Controlled Markov models can be solved by algorithms such as dynamic programming or reinforcement learning, which intends to identify or approximate the optimal policy (set of rules that maximizes the expected sum of discounted rewards).

In the medical literature, Markov models have explored very diverse problems such as timing of liver transplant [8], HIV therapy [9], breast cancer [10], Hepatitis C [11], statin therapy [12] or hospital discharge management [5, 13]. Markov models can be used to describe various health states in a population of interest, and to detect the effects of various policies or therapeutic choices. For example, Scott et al. has used a HMM to classify patients into 7 health states corresponding to side effects of 2 psychotropic drugs [14]. The transitions were analyzed to specify which drug was associated with the least side-effects. Very recently, a Markov chain model was proposed to model the progression of diabetic retinopathy, using 5 pre-defined states, from mild retinopathy to blindness [15]. MDPs have also been exploited in medical imaging applications. Alterovitz has used very large MDPs (800,000 states) for motion planning in image-guided needle steering [16].

Besides those medical applications, Markov models are extensively used in health economics research, which is the focus of the next section of this chapter.

## 24.3 Basics of Health Economics

### 24.3.1 *The Goal of Health Economics: Maximizing Cost-Effectiveness*

This section provides the reader with a minimal background about health economics, followed by a worked example. Health economics intends to maximize “value for money” in healthcare, by optimizing not only clinical effectiveness, but also cost-effectiveness of medical interventions. As explained by Morris: “Achieving ‘value for money’ implies either a desire to achieve a predetermined objective at least cost or a desire to maximise [sic] the benefit to the population of patients served from a limited amount of resources” [17].

Two main approaches can be outlined in health economics: cost-minimization and cost-effectiveness analysis (CEA). In both cases, the purpose is identical: to identify which treatment option is the most cost-effective. Cost minimization deals with the simple case where the several treatment options available have the same effectiveness but different costs. Quite logically, cost-minimization will favor the cheapest option. CEA represents a more likely scenario and is more widely used.

In CEA, several options with different costs and different effectiveness are compared. The analysis will compute the relative cost of an improvement in health, and metrics to optimally inform decision makers.

### 24.3.2 Definitions

#### ***Measuring Outcome: Survival, Quality of Life (QoL), Quality-Adjusted Life-Years (QALY)***

Outcomes are assessed in terms of enhanced survival (“*adding years to life*”) and enhanced quality of life (QoL) (“*adding life to years*”) [17]. Although sometimes criticized, the concept of Quality-adjusted life-years (QALY) remains of central importance in cost-utility analysis [18]. QALYs apply weights that reflect the QoL being experienced by the patient. One QALY equates to one year in perfect health. Perfect health is equivalent to 1 while death is equivalent to 0. QALYs are estimated by various methods including scales and questionnaires filled by patients or external examiners [19]. As an example, the EuroQoL EQ 5D questionnaire assesses health in 5 dimensions: mobility, self-care, usual activities, pain/discomfort and anxiety/depression.

#### ***Cost-Effectiveness Ratio (CER)***

The cost-effectiveness ratio (CER) will inform the decision makers about the cost of an intervention, relative to the health benefits this intervention generates. For example, an intervention costing \$20,000 per patient and providing 5 QALYs (5 years of perfect health) has a CER of  $\$20,000/5 = \$4000$  per QALY. This measure allows a direct comparison of cost-effectiveness between interventions.

#### ***Incremental Cost-Effectiveness Ratio (ICER)***

The incremental cost-effectiveness ratio (ICER) is a measure very commonly reported in the health economics literature and allows comparing two different interventions in terms of “cost of gained effectiveness.” It is computed by dividing the difference in cost of 2 interventions by the difference of their effectiveness [20].

As an example, if treatment A costs \$5000 per patient and provides 2 QALYs, and treatment B costs \$8000 while providing 3 QALYs, the ICER of treatment B will be:

$$\frac{(\$8000 - \$5000)}{3 - 2} = \$3000$$

Said otherwise, it will cost \$3000 more to gain one more QALY with treatment B, for this particular medical condition. ICER can inform decision makers about the

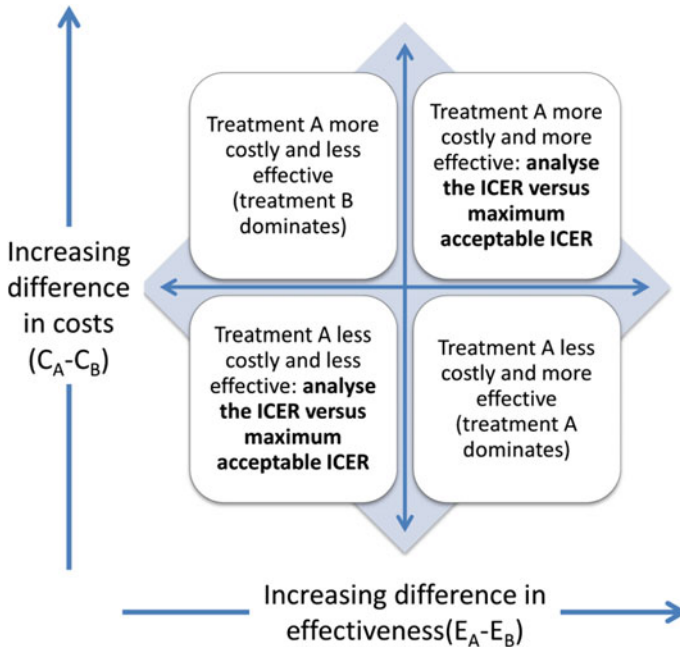


need to adopt or fund a new medical intervention. Schematically, if the ICER of a new medical intervention lies below a certain threshold, it means that health benefits can be achieved with an acceptable level of spending.

### *The Cost Effectiveness Plane*

The cost-effectiveness plane (CE plane) is an important tool used in CEA (Fig. 24.4). It aims to clearly illustrate differences in costs and effects between different strategies, whether they comprise medical interventions, treatments, or even a combination of the two.

The CE plane consists of a four-quadrant diagram where the X-axis represents the incremental level of effectiveness of an outcome and the Y-axis represents the additional total cost of implementing this outcome. For example, the further right you move on the X-axis, the more effective the outcome. In the upper-right quadrant, a treatment may receive funding if its ICER lies below the maximum acceptable ICER threshold.



**Fig. 24.4** The cost-effectiveness plane, comparing treatment A with treatment B

## 24.4 Case Study: Monte Carlo Simulations of a Markov Chain for Daily Sedation Holds in Intensive Care, with Cost-Effectiveness Analysis

This example is inspired by the publication by Girard et al. [21], and will allow us to illustrate how to construct and examine a simple Markov Chain to represent a medical intervention, how to relate QALYs and cost of interventions to each state of the Markov Chain, in order to carry out a cost-effectiveness analysis. In this prospective randomized controlled trial, the authors evaluated the impact of daily sedation holds in intensive care on various outcomes such as the number of ventilator-free days, delirium and 28-day mortality. In the ICU, patients frequently undergo mechanical ventilation in the setting of severely impaired consciousness, after heavy surgical procedures, and when suffering from severe respiratory failure. Therapeutically, patients are sedated to maximize their comfort. A growing body of literature, however, has identified the risks of continuous sedation in the ICU, as it is associated with increased mortality, delirium, duration of mechanical ventilation and length of ICU and hospital stay [22]. To strike the right balance between maintaining sedation and mechanical ventilator support as long as the patient needs it, but also moving to extubation as soon as possible, Girard and colleagues proposed actively waking up the patients daily to assess their readiness to come off of the ventilator. The main results are shown in Table 24.5.

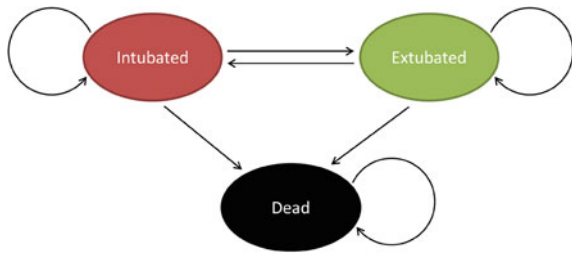
In this case study example, we will attempt to approximate those results using a very simple 3-state Markov Chain examined by MC simulation. As an exercise, we will extend the study to CEA. This tutorial will provide the reader with all the tools necessary to implement in other contexts Markov Chain MC simulation methods and simple cost-effectiveness studies.

Most of the study results can be approximated using a very crude 3-state Markov chain (Fig. 24.5), with the following state space: {Intubated, Extubated, Dead}. In this simplistic model, only 7 transitions are possible, and the state ‘dead’ is absorbing.

**Table 24.5** Main results from the original study

	Intervention group	Control group
Ventilator-free days (mean)	14.7	11.6
Ventilator-free days (median)	20.0	8.1
Patients Successfully extubated at 28 days (%)	≈93	≈88
28 day mortality (%)	29	35

**Fig. 24.5** The 3-state Markov chain used in this example



Two different transition matrices can be built by trial-and-error, corresponding to the intervention and control arms of the study (Table 24.6). They correspond to the daily probabilities of transitioning from one state to another. The initial values were selected using a few simple assumptions: the state ‘death’ is absorbing, the probability to remain intubated or extubated is larger than the probability to change state, the risk of dying while intubated is larger than when extubated, and the total of each row in the transition matrix is one. Another assumption is that the intervention (daily sedation hold) will change the probability of successful extubation and mortality, hence the transition matrix. After each modification, the number of patients in each state was computed for 28 days (results in Table 24.8), so as to try to match the initial study’s results as closely as possible.

We can check to see if our code is running correctly by comparing important aspects of the simulation to known theoretical properties of probability theory and Markov Chains. For example, in our example all patients are assumed to be intubated at  $t = 0$ . Under our Markov model, the waiting time until extubation or death can be determined theoretically, but how to determine this is beyond the scope of this chapter. This waiting time,  $W^*$ , is a discrete random variable with a geometric distribution. Geometric distributions have probability mass functions, for a given waiting time,  $w$  of  $p(w) = (1 - p)p^{(w-1)}$ , where  $p$  is the probability of remaining intubated. In Fig. 24.6, we compare the number of times we observed different values of  $w$  to what we would expect under the true theoretical distribution of  $W^*$ , by computing  $Np(w)$ , where  $N$  is the number of simulated instances we computed.

**Table 24.6** Transition matrices used in the case study

Intervention group		Next state S'		
		I	E	D
Initial state S	I	0.862	0.12	0.018
	E	0.0088	0.982	0.0092
	D	0	0	1
Control group		Next state S'		
		I	E	D
Initial state S	I	0.878	0.1	0.022
	E	0.01	0.978	0.012
	D	0	0	1

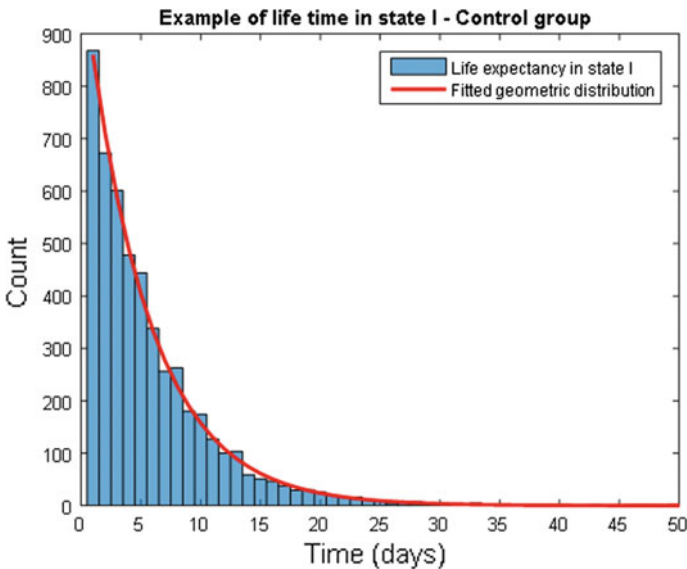
We can see that our simulation follows very closely to what is theoretically known to be true.

In order to perform CEA, each state must be assigned a value for QALYs and cost. For the purpose of this example, let's also assume the values for QALYs and daily costs shown in Table 24.7.

Table 24.8 shows the results of the first iterations for the control group, when starting with 100 patients intubated (*function* IED\_transition.m). At each time step, the number of patients still intubated corresponds to the patients who stayed intubated, minus the patients who became extubated (daily probability of 10 %) and those who died (probability of 2.2 %), plus the extubated patients who had to be re-intubated (probability 1 %). After 28 days, the cumulated mortality reaches 35.6 %, and the ratio of patients extubated among the patients still alive is 88.8 %, hence matching quite closely the results of the initial study. At each time step, the sum of the QALYs and costs for all the patients is computed, as well as their cumulative values. The number of QALYs initially increases as more patients become extubated, then decreases as a consequence the number of patients dying.

**Table 24.7** Definition of QALY and daily cost for each state

State	I	E	D
QALY	0.5	1	0
Daily cost (\$)	2000	1000	0



**Fig. 24.6** Example of the life expectancy in state “I” in the control group, with fitted geometric distribution. The bar chart represents the distribution of the time spent in the state “intubated” of the Markov chain, before transitioning to another state, for 5000 samples

**Table 24.8** Number of patients in each state, QALYs and cost analysis, during 28 iterations (control group)

Day	I	E	D	Extubated/Alive	QALYs	Cumulative QALYs	Daily cost (K \$)	Cumulative cost (K\$)
0	100.00	0.00	0.00	0.00	50.00	50.00	200.00	200
1	87.80	10.00	2.20	0.10	53.90	103.90	185.60	386
2	77.19	18.56	4.25	0.19	57.15	161.05	172.94	559
3	67.96	25.87	6.17	0.28	59.85	220.90	161.78	720
4	59.92	32.10	7.98	0.35	62.06	282.96	151.95	872
5	52.94	37.38	9.68	0.41	63.85	346.81	143.25	1016
...	...	...	...	...	...	...	...	...
28	7.19	57.21	35.60	0.89	60.80	1863.84	71.59	3184

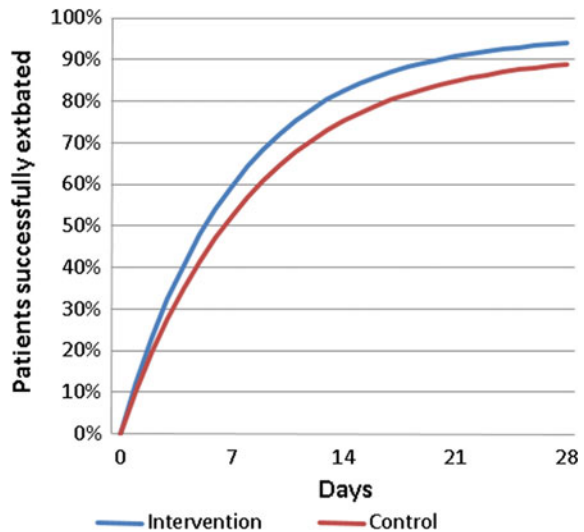
The following figure represents the ratio of number of patients extubated over number of patients alive, over time and for both strategies (Fig. 24.7). It can be compared to the original figure in the source article.

By simulating the distribution of the average number of ventilator-free days, and its characteristics, can be computed for both strategies (*function* `MCMC_solver.m`). The following Table 24.9 shows examples of patients' states computed using the transition matrix of the control group.

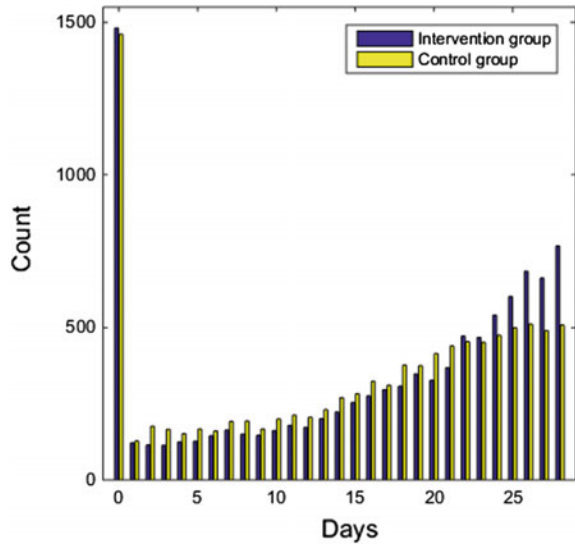
The distribution of ventilator-free days in our 10,000 samples is plotted shown in Fig. 24.8.

The mean and median number of ventilator-free days for both groups is shown in Table 24.10.

**Fig. 24.7** Modelled primary outcome of the study using a Markov chain



**Fig. 24.8** Ventilator-free days for 10,000 samples, for the intervention and control group



**Table 24.9** Computing the number of ventilator-free days by Monte Carlo (10,000 simulated instances)

Day	Instance 1	Instance 2	Instance 3	...	Instance 10,000
0	I	I	I		I
1	I	I	I		I
2	I	I	I		I
3	I	I	I		I
4	I	I	I		I
5	I	I	I		I
6	I	I	I		I
7	I	I	I		E
8	E	E	I		E
9	E	E	I		E
10	I	E	I		E
...	...	...	...		...
28	D	D	D		E
Total ventilator-free days	7	3	0	...	22

The cost-effectiveness ratio at 28 day of the both strategies can be computed by dividing the final cumulative cost by the cumulative QALYs (Table 24.11).

The intervention is more expensive but is also associated with health benefits (significantly more QALYs). It belongs to the upper-right quadrant of the CE plane,

**Table 24.10** Mean and median number of ventilator-free days for both groups

Number of ventilator-free days	Intervention group	Control group
Mean	17.1	15.9
Median	20	18

**Table 24.11** Cost-effectiveness ratio in both groups

	Intervention group	Control group
Cumulative cost (K\$)	3213	3184
Cumulative QALYs	2029	1864
Cost-effectiveness ratio (\$ per QALY)	1583	1708

where the ICER is used to determine the cost-effectiveness of an intervention. The ICER of this intervention is shown below:

$$ICER = \frac{(3,213,000 - 3,184,000)}{(2029 - 1864)} = 177.3$$

According to this crude analysis, Sedation holds appear to be a very cost-effective strategy, costing only \$177 more per additional QALY, relative to the control strategy. Reducing the value (QALY) of the state E from 1 to 0.6 significantly increases the ICER to \$1918 per QALY gained, demonstrating the huge impact that the definition of our health states has on the results of the CEA. Likewise, increasing the daily cost of state E from \$1000 to \$1900 (now only slightly cheaper than state I) leads to a much more expensive ICER of \$2041 per QALY gained. Some medical interventions may or may not be funded depending on the assumptions of the model!

## 24.5 Model Validation and Sensitivity Analysis for Cost-Effectiveness Analysis

An important component to any CEA is to assess whether the model is appropriate for the phenomena being examined, which is the purpose of model validation and sensitivity analyses. In the previous section, we model daily sedation hold as a Markov chain with a known transition probability matrix and costs. Deviations from this model can come in at least two types.

First, the use of a Markov Chain may be inappropriate to describe how subjects transition from the intubation, extubation and death states. It was presumed that this process follows a first-order Markov chain. Given enough real clinical data we can test to see if this assumption is reasonable. For example, given the transition probability matrices above, we can calculate quantities via MC simulation and

compare them to values reported in the real data. For instance, the authors report a 28-day mortality rate of 29 and 35 % in the intervention and control groups, respectively. From our simulation study, we estimate these quantities to be 27 and 35 %, which is reasonably close. One can perform formal goodness-of-fit testing as well to better assess if any differences noted provide any evidence that the model may be mis-specified. This process can also be repeated for other quantities, for example, the mean number of ventilator-free days.

In addition to validating the Markov model used to simulate the states and transitions for the system of interest, it is also important to perform a sensitivity analysis on the assumptions and parameters used in the simulation. Performing this step allows one to see how sensitive the results are to slight changes to parameter values. Choosing which parameters values to use in sensitivity analyses can be difficult, but some good practices are to find other parameters (e.g., transition probability matrices) reported in other studies of a similar type. For cost estimates, one may want to try costs reported in other countries, or incorporate important economic parameters like inflation. If using these other scenarios drastically affects the conclusions drawn from the simulation study, this does not necessarily mean that the study was a failure, but rather that there are limits to the generalizability of the simulation study's results. If particular parameters cause great fluctuations this may warrant further investigation into why this is the case. In addition to changing the parameters, one may try to alter the model significantly, by for example, using a higher order Markov model or semi-Markov model in place of a simple first order assumption, but these are advanced topic beyond the scope of this chapter.

The theoretical concepts introduced in the first sections of this chapter were applied to a concrete example coming from the medical literature. We demonstrated how clinical states and transition probabilities could be defined ad hoc, and how the stationary distribution of the chain could be estimated using Monte Carlo methods. The methodology outlined in this chapter will allow the reader to expand the results of other interventional studies to CEA, but countless other applications of Markov models exist, in particular in the domain of decision support systems.

## 24.6 Conclusion

Markov models have been used extensively in the medical literature, and offer an appealing framework for modeling medical decision making, with potential powerful applications in decision support systems and health economics analysis. They represent relatively simple mathematical models that are easy to grasp by non-data scientists or non-statisticians. Very careful attention must be paid to the verification of a fundamental assumption which is the Markov property, without which no further analysis should be carried out.



## 24.7 Next Steps

This tutorial hopefully provided basic tools to understand or develop CEA and Markov chains to model the effect of medical interventions. For more information on health economics, the reader is directed towards external references, such as the work by Morris and colleagues [17]. Guidance regarding the use of more advanced Markov models such as MDPs and HMMs is beyond the scope of this book, but numerous sources are available, such as the excellent Sutton and Barto, freely available online [4].

**Open Access** This chapter is distributed under the terms of the Creative Commons Attribution-NonCommercial 4.0 International License (<http://creativecommons.org/licenses/by-nc/4.0/>), which permits any noncommercial use, duplication, adaptation, distribution and reproduction in any medium or format, as long as you give appropriate credit to the original author(s) and the source, a link is provided to the Creative Commons license and any changes made are indicated.

The images or other third party material in this chapter are included in the work's Creative Commons license, unless indicated otherwise in the credit line; if such material is not included in the work's Creative Commons license and the respective action is not permitted by statutory regulation, users will need to obtain permission from the license holder to duplicate, adapt or reproduce the material.

## Code Appendix

The code used in this case study is available from the GitHub repository accompanying this book: <https://github.com/MIT-LCP/critical-data-book>. Further information on the code is available from this website. The following functions are provided:

- `health_forecast.m`: This function computes 100 Monte-Carlo simulations of a 5-day health forecast and displays the results.
- `IED_transition.m`: This function computes and displays the proportion of patients in each state (Intubated, Extubated, or Dead), following the transition matrix in the intervention group.
- `MCMC_solver.m`: This function computes 10,000 Monte Carlo simulations for both the control and intervention group, and computes the distribution of ventilator-free days.

## References

1. Basharin GP, Langville AN, Naumov VA (2004) The life and work of A.A. Markov. *Linear Algebra Appl* 386:3–26
2. Sonnenberg FA, Beck JR (1993) Markov models in medical decision making: a practical guide. *Med Decis Mak Int J Soc Med Decis Mak* 13(4):322–338

3. Schaefer AJ, Bailey MD, Shechter SM, Roberts MS (2005) Modeling medical treatment using Markov decision processes. In: Brandeau ML, Sainfort F, Pierskalla WP (eds) *Operations research and health care*. Springer, US, pp 593–612
4. Sutton RS, Barto AG (1998) *Reinforcement learning: an introduction*. A Bradford Book, Cambridge, Mass
5. Kreke JE (2007) Modeling disease management decisions for patients with pneumonia-related sepsis [Online]. Available: <http://d-scholarship.pitt.edu/8143/>
6. Liu JS (2004) *Monte Carlo strategies in scientific computing*. Springer, New York
7. Zucchini W, MacDonald IL (2009) *Hidden Markov models for time series: an introduction using R*. Chapman and Hall/CRC, Boca Raton (2Rev Ed edition)
8. Alagoz O, Maillart LM, Schaefer AJ, Roberts MS (2004) The optimal timing of living-donor liver transplantation. *Manag Sci* 50(10):1420–1430
9. Shechter SM, Bailey MD, Schaefer AJ, Roberts MS (2008) The optimal time to initiate HIV therapy under ordered health states. *Oper Res* 56(1):20–33
10. Maillart LM, Ivy JS, Ransom S, Diehl K (2008) Assessing dynamic breast cancer screening policies. *Oper Res* 56(6):1411–1427
11. Daniel PMG, Faissol M (2007) Timing of testing and treatment of hepatitis C and other diseases. *Inf J Comput Inf*
12. Denton BT, Kurt M, Shah ND, Bryant SC, Smith SA (2009) Optimizing the start time of statin therapy for patients with diabetes. *Med Decis Mak Int J Soc Med Decis Mak* 29(3):351–367
13. Raffa JD, Dubin JA (2015) Multivariate longitudinal data analysis with mixed effects hidden Markov models. *Biometrics* 71(3):821–831
14. Scott SL, James GM, Sugar CA (2005) Hidden Markov models for longitudinal comparisons. *J Am Stat Assoc* 100:359–369
15. Srikanth P (2015) Using Markov chains to predict the natural progression of diabetic retinopathy. *Int J Ophthalmol* 8(1):132–137
16. Alterovitz R, Branicky M, Goldberg K (2008) Motion planning under uncertainty for image-guided medical needle steering. *Int J Robot Res* 27(11–12):1361–1374
17. Morris S, Devlin N, Parkin D, Spencer A (2012) *Economic analysis in healthcare*, 2nd edn. Wiley, Chichester
18. Nord E, Daniels N, Kamlet M (2009) QALYs: some challenges. *Value Health* 12(Supplement 1):S10–S15
19. Torrance GW (1986) Measurement of health state utilities for economic appraisal. *J Health Econ* 5(1):1–30
20. Drummond M, Sculpher M (2005) Common methodological flaws in economic evaluations. *Med Care* 43(7 Suppl):5–14
21. Girard TD, Kress JP, Fuchs BD, Thomason JWW, Schweickert WD, Pun BT, Taichman DB, Dunn JG, Pohlman AS, Kinniry PA, Jackson JC, Canonico AE, Light RW, Shintani AK, Thompson JL, Gordon SM, Hall JB, Dittus RS, Bernard GR, Ely EW (2008) Efficacy and safety of a paired sedation and ventilator weaning protocol for mechanically ventilated patients in intensive care (awakening and breathing controlled trial): a randomised controlled trial. *Lancet Lond Engl* 371(9607):126–134
22. Roberts DJ, Haroon B, Hall RI (2012) Sedation for critically ill or injured adults in the intensive care unit: a shifting paradigm. *Drugs* 72(14):1881–1916

# Chapter 25

## Blood Pressure and the Risk of Acute Kidney Injury in the ICU: Case-Control Versus Case-Crossover Designs

Li-wei H. Lehman, Mengling Feng, Yijun Yang and Roger G. Mark

### Learning Objectives

Introduce two different approaches, a case-control and a case-crossover design, to study the effect of transient exposure of hypotension on the risk of acute kidney injury (AKI) development in intensive care unit (ICU) patients.

### 25.1 Introduction

Acute kidney injury (AKI) refers to a rapid decrease in kidney function, occurring over a period of days. The presence of AKI can be detected using well-established definitions based on serum creatinine rise or urine output reduction [1]. Acute kidney injury has been reported in 36 % of all patients admitted to the intensive care unit ICU [2, 3]. A prior study showed that hospital patients with even very small increases in their serum creatinine (0.3–0.4 mg/dL) have 70 % greater risk of death than patients without creatinine increase [4]. Although the relationship between low blood pressure and kidney function is well documented in an experimental setting based on animal data [5], the association between hypotension and acute kidney injury in a critical care setting is not completely understood.

This chapter describes two different approaches for studying blood pressure and the risk of AKI development in ICU patients using the MIMIC II database [6]. In our first study, we adopted a traditional case-control approach and examined the association between hypotension and AKI by comparing blood pressure measurements of patients who had AKI (case) with patients without AKI (control) [7, 8]. Blood pressure measurements immediately prior to patients' AKI onset were compared with blood pressure measurements of the controls sampled from a similar time window.

In the second study, we adopted a case-crossover design in which each patient serves as his or her own control. Blood pressure measurements immediately prior to each patient's AKI onset were compared with the same patient's blood pressure

measurements sampled from an earlier time window while that patient's kidney functions were still stable. In the remainder of the chapter, we highlight the key differences and the design rationale of these two approaches. We applied these analysis techniques to study the relationship between hypotension and AKI development using the MIMIC II database, and present our preliminary findings.

## 25.2 Methods

### 25.2.1 *Data Pre-processing*

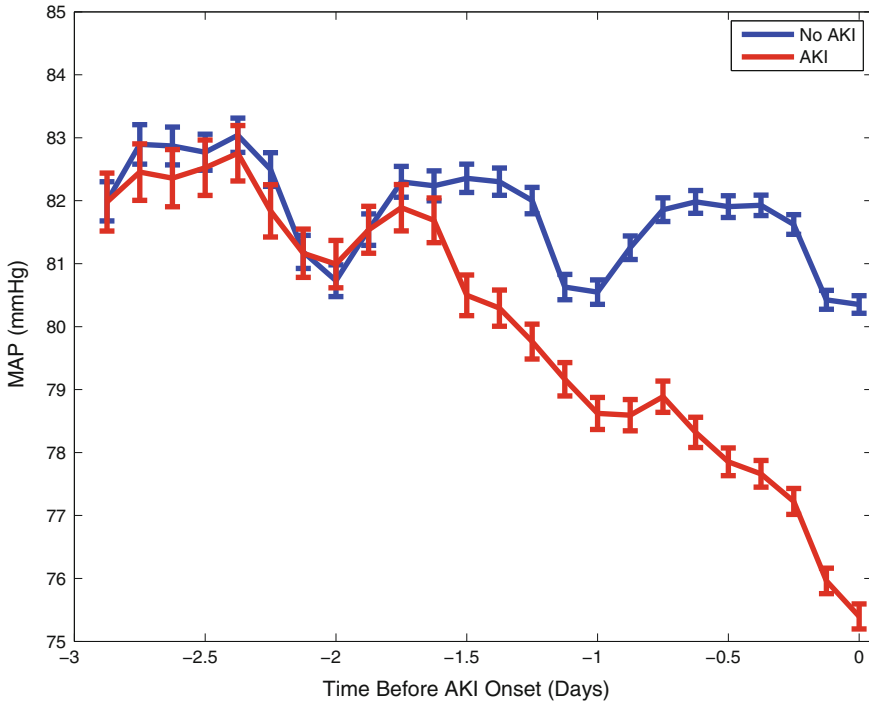
Nurse-verified mean arterial blood pressure (MAP) samples, recorded on an hourly basis were used for the analysis. Blood pressure measurements from both invasive arterial line and automated, non-invasive oscillometric methods were included in the study. Our choice of MAP (rather than systolic blood pressure) for blood pressure measurement was motivated by prior work [8] which demonstrated that MAP provided more consistent readings across different measurement modalities in the ICU. Blood pressure measurements were filtered to remove values outside of reasonable physiological bounds (MAP between 20 and 200 mmHg).

### 25.2.2 *A Case-Control Study*

In the case-control approach [7], we examined the effect of transient exposure to hypotension (defined as blood pressure falling below specified thresholds) and the risk of AKI development by comparing blood pressure measurements of patients who experienced AKI (case) with patients who never developed AKI in the ICU (control). AKI was defined as an acute increase in serum creatinine  $\geq 0.3$  mg/dL, or an increase of  $\geq 50\%$  in serum creatinine within 48 h, based on the Acute Kidney Injury Network (AKIN) definition [1]. Blood pressure measurements (from up to a 48 h window) prior to patients' AKI onset were compared with blood pressure measurements of the controls from a time window prior to the last creatinine measurement time.

Patients were selected from among the adult ICU stays in the MIMIC II [8] database. We examined adult ICU stays (patients  $\geq 15$  years of age) with at least 2 serum creatinine values. Patients with fewer than 2 serum creatinine values in their ICU stay or evidence of end-stage renal disease (ESRD) were excluded.

Among the remaining 16,728 adult ICU stays that had at least 2 creatinine measurements without evidence of end-stage renal disease, AKI occurred in 5207 (31%). The remaining 11,521 cases were identified as the controls. The average AKI onset time was 2.34 days after ICU admission. For the controls, the last creatinine sample time was, on average, 2.76 days after ICU admission. Figure 25.1



**Fig. 25.1** The population mean (and standard error) of median MAP up to 3 days prior to the AKI onset for the AKI cohort, or prior to the last creatinine measurement time for the controls. Mean arterial blood pressure of the AKI cohort diverged from that of the controls during day two prior to the AKI onset, and both cohorts exhibited prominent diurnal variation

plots the population mean and standard error of median MAP up to 3 days prior to the AKI onset for the AKI cohort, or prior to the last creatinine measurement time for the controls. Note that mean arterial blood pressure of the AKI cohort diverged from that of the controls prior to the AKI onset.

We studied the risk of AKI in ICU patients as a function of both the severity and duration of hypotension. Blood pressure features extracted from the target 48-h window were examined as primary predictors for AKI, including the minimum MAP and maximum number of hours that MAP was continuously less than several different thresholds (from 80 to 45 mmHg). Duration of hypotension below a specific threshold was calculated based on linear interpolated blood pressure samples. Hypotensive episodes were considered to begin and end when the interpolated blood pressure values intercepted the target threshold. Hypotensive episodes that were less than one hour apart were merged to form one continuous episode.

Univariate and multivariable logistic regressions were performed to find correlations between hypotension and AKI. Age, SAPS-I, admission creatinine, and the

presence (based on ICD-9) of chronic renal failure (585.9), hypertension (401.9), diabetes (250.00), coronary atherosclerosis (414.01), congestive heart failure (428.0), and septic shock (785.52) or sepsis (038) were added as potential confounding factors [9].

Our results indicate that the odds of AKI were related to the severity of hypotension with an odds ratio (OR) of 1.03, 95 % confidence interval (CI) 1.02–1.04 ( $p < 0.0001$ ) per 1 mmHg decrease in minimum MAP  $\leq 80$  mmHg. Multivariable analysis on hypotension duration involved 3203 patients who had SAPS-I scores and with at least 45 h of blood pressure samples in the target 48-h window. Our results indicate that the duration of time that the patient's MAP was continuously less than or equal to 70, 65, 60, 55, and 50 mmHg were significant risk factors in AKI development. Further, as the extent of hypotension worsened, the incremental risk for AKI from each additional hour of continuous hypotension increased for each 10 mmHg drop in MAP below 80 mmHg. For each additional hour MAP was less than 70, 60, 50 mmHg, the odds of AKI increased by 2 % (OR 1.02, 95 % CI 1.00–1.03,  $p = 0.0034$ ), 5 % (OR 1.05, 95 % CI 1.02–1.08,  $p = 0.0028$ ), and 22 % (OR 1.22, 95 % CI 1.04–1.43,  $p = 0.0122$ ) respectively. As the degree of hypotension worsened, the increased odds for AKI from each additional hour of continuous hypotension more than doubled for each 10 mmHg drop in MAP below 80 mmHg. Our results also suggest that the severity of hypotension significantly shortened the time to the onset of AKI.

### 25.2.3 A Case-Crossover Design

In the second study, we adopted a case-crossover cohort design to examine the effect of transient exposure to hypotension and the risk of AKI. The case-crossover design was devised to assess the relationship between transient exposures and acute outcomes in situations where the control series of a case-control study is difficult to achieve. In the case-crossover design, subjects serve as their own matched controls defined by prior time periods in the same subject. Given a transient exposure with stable prevalence over time, the case-crossover design uses the difference in exposure rates just before an event (case) with those at other time points in the subject's history (controls) to estimate an odds ratio of the outcome associated with exposure. The case-crossover design was first proposed by Maclure et al. to study the effects of transient changes on the risk of acute events [10]. One advantage of a case-crossover design is that it avoids control selection bias and eliminates between-patient confounding factors [10, 11]. In this study design, the AKI definition is based on hourly urine output (instead of daily creatinine measurements) in order to determine a more precise timing of the acute (oliguria) onset.

Adult patients with normal kidney function (i.e. urine output remaining at 0.5 ml/kg/h or above) during the first 12 h in the ICU, who subsequently developed

AKI/oliguria (urine output remains below 0.5 ml/kg/h for at least 6 h) in the ICU were included in the study. The same patients, prior to developing AKI/oliguria, were used as controls. The AKI/oliguria onset was defined as the beginning of the 6-h period when urine output remained below 0.5 ml/kg/h.

The minimum MAP from the 3 h period prior to the AKI onset was used as exposure for the cases. The minimum MAP from a 3-h control period during the first 12 h in the ICU, when the same patient's renal function was still normal, was used as exposure for the controls. Since the blood pressure measurements during the first 6 h patients were in the ICU can be sparse, we chose the control period to be the 7th–9th hour from the beginning of the patients' ICU stays. Blood pressure measurements were filtered to remove outliers as before.

Case-crossover designs are typically analyzed using conditional logistic regression, as it accounts for the matched nature of the data. It is analogous to a matched case-control study, where one compares a 'case' person-moment with a series of 'control' person-moments from different subjects, while in the case-crossover design, the 'control' person-moments are from the same subject. We implemented the latter approach for analyzing case-crossover study data. In addition, time-varying confounding factors (mechanical ventilator, vasopressors, temperature, heart rate, white blood cell count, SpO<sub>2</sub>) were included in the multivariable conditional logistic regression model.

The total cohort included 911 adult ICU stays (29.86 % MICU, 21.73 % SICU, 22.94 % CCU, 25.47 % CSRU) from the MIMIC II database. The median time to AKI/oliguria onset was 45 h. The population median of the minimum MAP measurements during the control and case periods were 73 mmHg with an inter-quartile range of [65, 83] mmHg, and 70 [62, 79] mmHg respectively. A paired signed T-test indicates that the minimum MAP during the case period is statistically significantly lower than during the control period ( $p$ -value = 0.0001). Our results indicate that the odds of AKI were related to the severity of hypotension with an odds ratio (OR) of 1.035, 95 % confidence interval (CI) 1.024–1.045 ( $p < 0.0001$ ) per 1 mmHg decrease in minimum MAP in multivariable conditional logistic regression after adjusting for temperature, heart rate, SpO<sub>2</sub>, white blood cell count, and the use of mechanical ventilation and vasopressors. Furthermore, we performed a similar analysis to understand if the risk of developing AKI increases associated with the worsened hypotension treating the minimum MAP at the binary variable using cutoff of 70, 65, 60, 55, and 50 mmHg. The adjusted odds ratios and 95 % CI for the minimum MAP < 70, MAP < 65, MAP < 60, MAP < 55, and MAP < 50 (vs. when MAP was greater than or equal to the respective thresholds) were 1.854 (1.44–2.38), 1.945 (1.502–2.519), 2.096 (1.532–2.869), 2.002 (1.307–3.065), and 2.107 (1.115–3.982), respectively. These findings are consistent with the results described in the previous section using a case-control study design.

## 25.3 Discussion

In the study of the association of hypotension with AKI, the case-crossover design is an efficient alternative to the case-control approach. The case-crossover design, based exclusively on the case series, performs within-subject comparisons of blood pressure measurements from the case and the control periods to estimate the rate ratio of the AKI outcome associated with hypotension. This design inherently removes the biasing effects of unmeasured, time-invariant confounding factors from the estimated rate ratio.

Many factors, (including chronic kidney disease, hypertension, diabetes) could potentially contribute to the development of AKI in an ICU setting. In a traditional case-control design, these time-invariant between-patient confounders (as well as the time-varying confounders) would have to be included to adjust for the baseline risk of AKI development. In some cases, these confounding variables can be difficult to determine from a retrospective ICU database. In a case-crossover design, each patient's blood pressure during normal renal function is compared with the same patient's blood pressure immediately prior to AKI onset, so that time-invariant patient characteristics and confounders are eliminated in the analysis. A case-crossover design may be a more efficient approach in investigating the transient effect of exposure (e.g. low blood pressure) on the risk of an acute outcome (e.g. AKI development), when the heterogeneity in the baseline risk may be difficult to account for in the conventional case-control design.

We acknowledge the following limitations in the current study. First, this was a retrospective study, and as such, the incidence of hypotension prior to AKI does not prove a causal mechanism. Second, we did not account for the presence of fluid and several interventions (e.g. contrast agents, NSAIDs, aminoglycosides, ACEI, etc.) that may impair renal function in our multivariable analysis. As part of future work, additional time-varying confounders (such as, usage of Lasix within 6 h, IV fluid, creatinine, time of AKI onset) could be included in the model.

## 25.4 Conclusions

We have presented two different approaches, a case-control and a case-crossover design, to study the effect of transient exposure to hypotension on the risk of AKI development in ICU patients. Results from multivariable analysis in both studies indicate that hypotension is a statistically significant risk factor in the development of AKI in the ICU. This study serves as an example to illustrate the utility of case-crossover designs to study the association between a risk factor and the subsequent disease development in an EHR-based retrospective clinical analysis.

**Open Access** This chapter is distributed under the terms of the Creative Commons Attribution-NonCommercial 4.0 International License (<http://creativecommons.org/licenses/by-nc/4.0/>), which permits any noncommercial use, duplication, adaptation, distribution and reproduction



in any medium or format, as long as you give appropriate credit to the original author(s) and the source, a link is provided to the Creative Commons license and any changes made are indicated.

The images or other third party material in this chapter are included in the work's Creative Commons license, unless indicated otherwise in the credit line; if such material is not included in the work's Creative Commons license and the respective action is not permitted by statutory regulation, users will need to obtain permission from the license holder to duplicate, adapt or reproduce the material.

## Code Appendix

The code used in this case study is available from the GitHub repository accompanying this book: <https://github.com/MIT-LCP/critical-data-book>. Further information on the code is available from this website.

## References

1. Mehta RL, Kellum JA, Shah SV, Molitoris BA, Ronco C, Warnock DG, Levin A (2007) Acute kidney injury network (AKIN): report of an initiative to improve outcomes in acute kidney injury. *Crit Care* 11:R31
2. Bagshaw S, George C, Dinu I, Bellomo R (2008) A multi-center evaluation of the RIFLE criteria for early acute kidney injury in critically ill patients. *Nephrol Dial Transplant* 23:1203–1210
3. Ostermann M, Chang R (2007) Acute kidney injury in the intensive care unit according to rifle. *Crit Care Med* 35:1837–1843
4. Chertow G, Burdick E, Honour M, Bonventre J, Bates D (2005) Acute kidney injury, mortality, length of stay, and costs in hospitalized patients. *J Am Soc Nephrol* 16:3365–3370
5. Kirchheim HR, Ehmke H, Hackenthal E, Löwe W, Persson P (1987) Autoregulation of renal blood flow, glomerular filtration rate and renin release in conscious dogs. *Pflugers Archiv Eur J Physiol* 410:441–449
6. Saeed M, Villarroel M, Reisner AT, Clifford G, Lehman LH, Moody G, Heldt T, Kyaw TH, Moody B, Mark RG (2011) Multiparameter intelligent monitoring in intensive care (MIMIC II): a public-access intensive care unit database. *Crit Care Med* (5):952–960
7. Lehman LH, Saeed M, Moody G, Mark R (2010) Hypotension as a risk factor for acute kidney injury in ICU patients. In: *Computing in cardiology 2010*. IEEE Computer Society Press, Belfast, pp 1095–1098
8. Lehman LH, Saeed M, Talmor D, Mark RG, Malhotra A (2013) Methods of blood pressure measurement in the ICU. *Crit Care Med* 41(1):3–40
9. Abuelo G (2007) Normotensive ischemic acute renal failure. *N Engl J Med* 357:797–805
10. Maclure M (1991) The case-crossover design: a method for studying transient effects on the risk of acute events. *Am J Epidemiol* 133:144–153
11. Maclure M, Mittleman M (2000) Should we use a case-crossover design. *Annu Rev Public Health* 21:193–221

# Chapter 26

## Waveform Analysis to Estimate Respiratory Rate

Peter H. Charlton, Mauricio Villarroel and Francisco Salguiero

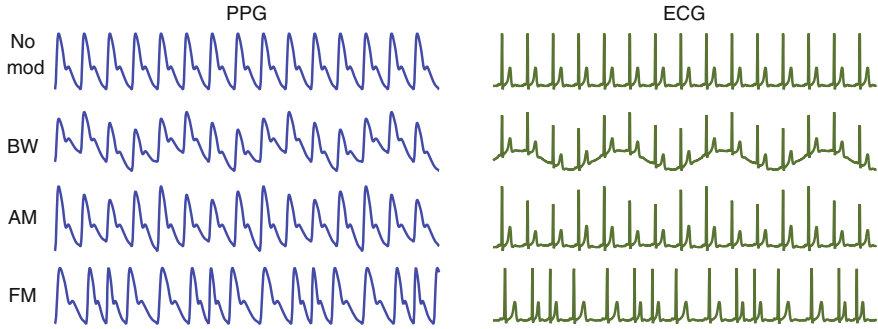
### Learning Objectives

Use the MIMIC II database to compare the performance of multiple algorithms for estimation of respiratory rate (RR) from physiological waveforms.

1. Extract electrocardiogram (ECG), photoplethysmogram (PPG) and thoracic impedance pneumography (IP) waveforms from the MIMIC II database.
2. Identify periods of low quality waveform data.
3. Identify heart beats in the ECG and PPG signals.
4. Estimate RR from the signals.
5. Improve the accuracy of RR estimation using quality assessment and data fusion.
6. Evaluate the performance of RR algorithms.

### 26.1 Introduction

Respiratory rate (RR) is an important physiological parameter which provides valuable diagnostic and prognostic information. It has been found to be predictive of lower respiratory tract infections [1], indicative of the severity of pneumonia [2], and associated with mortality in paediatric intensive care unit (ICU) patients [3]. Respiratory rate is measured in breaths per minute (bpm). Current routine practice for obtaining RR measurements outside of Critical Care involves manually counting chest movements [4]. This practice is time-consuming, inaccurate [5], and poorly carried out [6–8]. Therefore, there is an urgent need to develop an accurate, automated method for measuring RR in ambulatory patients. Furthermore, an automated method of measuring RR could facilitate: (i) objective patient-led home-monitoring of asthma; (ii) screening for obstructive sleep apnea; and (iii) screening for periods of



**Fig. 26.1** Idealised respiratory modulations of the PPG (*left hand side*) and ECG (*right hand side*). During three respiratory cycles, from *top*: no modulation, baseline wander (BW), amplitude modulation (AM), and frequency modulation (FM). Adapted from [18, 27, 30]

dysregulated breathing during sleep, occasionally seen in advanced congestive heart failure.

A potential solution is to estimate RR from a convenient non-invasive signal which is modulated by respiration and is easily, and preferably routinely, measured. Two such signals are the electrocardiogram (ECG) and the photoplethysmogram (PPG). Both signals exhibit baseline wander (BW), amplitude modulation (AM) and frequency modulation (FM) due to respiration, as shown in Fig. 26.1 (see [9, 10] for further details). Furthermore, both signals can be acquired continuously from ambulatory patients using novel wearable sensors. For example, the SensiumVitals<sup>®</sup> system (Sensium Healthcare) provides continuous ECG monitoring using a lightweight patch with a battery life of up to five days. The ViSi Mobile<sup>®</sup> (Sotera Wireless) provides continuous ECG and PPG monitoring using a wrist-worn monitor with additional ECG electrodes. In addition, non-contact video-based technology is being developed for continuous monitoring of the PPG without the need for any equipment to be attached to a patient [11].

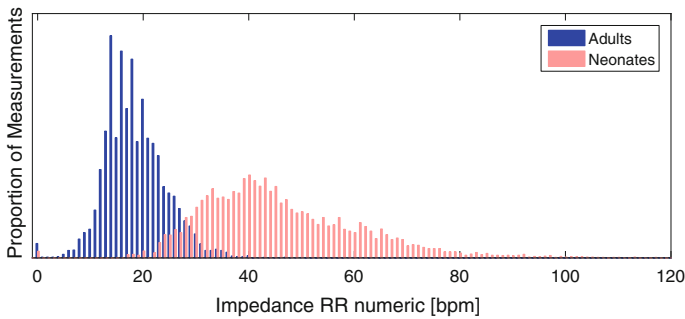
Many algorithms have been developed for estimating RR from the ECG and PPG [10, 12], but have not yet been widely adopted into clinical practice. In this case study we demonstrated the application of exemplary techniques to the ECG and PPG. The performance of these techniques was assessed on an example dataset. The case study is accompanied by MATLAB<sup>®</sup> code, equipping the reader with tools to develop and test their own RR algorithms for estimation of RR from physiological waveforms.

## 26.2 Study Dataset

PhysioNet's MIMIC II database (Version 3) was chosen for this study since it contains simultaneous ECG, PPG and thoracic impedance pneumography (IP) waveforms [13, 14]. IP signals, usually only measured in critical care, can be

**Table 26.1** Criteria for determining whether each of the 100 downloaded MIMIC II database records were included in the analysis

Criterion	Percent of records meeting criterion
Contain all the required waveforms (ECG, PPG and thoracic impedance)	76
Contain all the required numerics [heart rate (HR), pulse rate (PR) and respiratory rate (RR)]	64
Required waveforms and numerics last at least 10 min	51

**Fig. 26.2** Reference respiratory rate (RR) measurements acquired using thoracic impedance from adults and neonates. The disparity between the distributions of RR measurements acquired from adults (*blue*) and neonates (*red*) prompted a sub-group analysis of these two patient populations

used to estimate reference RRs since individual breaths can be identified as the thoracic impedance increases during inhalation and decreases during exhalation. `MIMICII_data_importer.m` was used in conjunction with the freely available *WFDB Toolbox*<sup>1</sup> to download the data. One hundred Intensive Care Unit (ICU) stay records, each containing data from a distinct ICU stay, were downloaded.

Records meeting the criteria in Table 26.1 were included in the analysis. The required waveforms and numerics were extracted from the 51 % of records that met these criteria. Each data channel was stored in two vectors of values and corresponding timestamps. This ensured that any gaps in the data due to changes in patient monitoring or data acquisition failures were preserved in the analysis.

Inspection of the dataset revealed a substantial difference in the distributions of IP RR measurements acquired from neonatal and adult patients, as illustrated in Fig. 26.2. This is in keeping with previous findings in [15], in which it was reported that children's RRs decrease from a median of 43 bpm when younger than

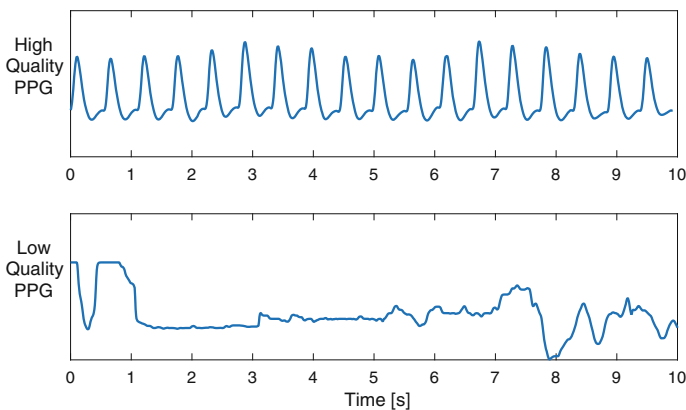
<sup>1</sup>*WFDB Toolbox* is available from PhysioNet: <http://physionet.org/physiotools/matlab/wfdb-app-matlab/>.

3 months to a median of 16 bpm when aged 15–18 years. Therefore, we decided to restrict the analysis to adult patients only.

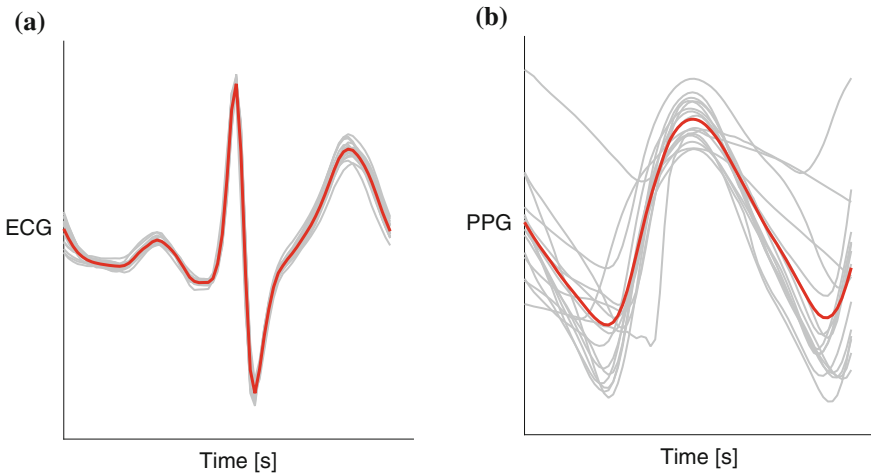
### 26.3 Pre-processing

The extracted waveforms contained periods of high and low (reliable and unreliable) quality, as shown in Fig. 26.3. This is in keeping with the literature, where it is well reported that physiologic signals can be expected to contain periods of artifact in the Critical Care setting [16]. Each 10 s segment of ECG and PPG data was categorised as either high or low quality using the signal quality indicator (SQI) reported in [17]. This SQI determines the quality of the signal in two steps. Firstly, heart beats are detected to quantify the detected heart rate. Any segments containing physiologically implausible heart rates are deemed to be low quality. Secondly, template matching is used to quantify the correlation between an averaged beat’s morphology and that of each individual beat. If the average correlation coefficient across a segment is below an empirical threshold, then the signal quality is deemed to be low (as shown in Fig. 26.4). Low quality segments were eliminated from the analysis.

The RR measurements provided by the clinical monitor were not used as a reference against which to test the accuracy of RR algorithms since they are susceptible to inaccuracies during periods of signal artifact. Instead, reference RRs were extracted from the IP signal, with periods in which reference RRs were unreliable being excluded from the analysis. To do so, the signal was segmented into non-overlapping 32 s windows. Two independent methods were used to estimate RR from each window in line with the methodology presented in [18]. Firstly, Fourier analysis was used to compute the power spectral density of the signal, as described in [19]. A first RR estimate was obtained as the frequency



**Fig. 26.3** Periods of high and low quality PPG waveform



**Fig. 26.4** Use of a template-matching signal quality index (SQI) to determine whether a segment of signal is high or low quality. **a** the ECG beats (*grey*) all have a similar morphology to the average beat template (*red*), and the ECG segment is deemed to be high quality. **b** the PPG beats have a highly variable morphology, indicating low signal quality

corresponding to the maximum power within the range of plausible respiratory frequencies (4–60 bpm). Secondly, the “count-orig” method presented in [20] was used to detect individual breaths. A second RR estimate was calculated from the average duration of individual breaths. Count-orig involves normalising the signal, identifying pairs of maxima exceeding a threshold value, and identifying reliable breaths as periods of signal between the pairs of maxima which contain only one minimum below zero. Finally, if the difference between the two RR estimates was  $< 2$  bpm, then the reference RR was calculated as the mean of the two estimates. Otherwise, the window was excluded.

## 26.4 Methods

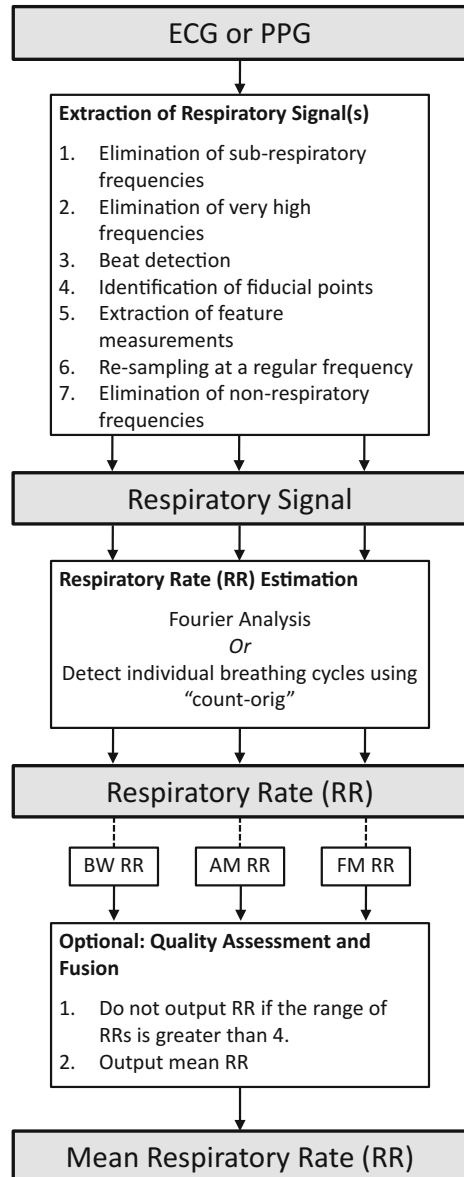
A plethora of algorithms have been proposed for estimation of RR from the ECG or PPG. In this case study we implemented exemplary algorithms (using `RRest.m`) which estimate RR by exploiting one of the three fundamental respiratory modulations, modelled on the approach described in [19]. RR algorithms generally consist of two compulsory components and two optional components. The compulsory components are:

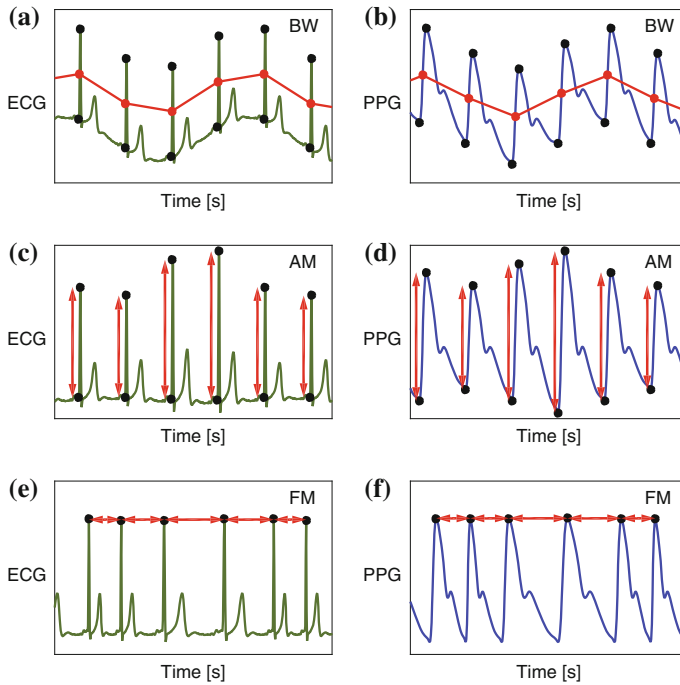
- extraction of a respiratory signal (a time series dominated by respiratory modulation) from the raw signal, and
- estimation of RR from the respiratory signal.

Two optional components, quality assessment and fusion, can be used to improve the accuracy of estimated RRs.

Extraction of a respiratory signal is often performed using a feature-based technique, which extracts a time series of beat-by-beat feature measurements. Figure 26.5 shows the steps involved. The first two steps, the elimination of sub-respiratory (<4 bpm) and very high frequencies (>100 Hz and >35 Hz for the

**Fig. 26.5** The steps within a respiratory rate (RR) algorithm. Extraction of respiratory signal(s) and RR estimation are compulsory. The third step consisting of quality assessment and fusion is optional





**Fig. 26.6** Feature measurement from fiducial points of the ECG and PPG signals. **a** and **b** Measurement of baseline wander (*BW*), the mean of the amplitudes of a beat's peak and trough; **c** and **d** amplitude modulation (*AM*), the difference between the amplitudes of each beat's peak and trough; **e** and **f** frequency modulation (*FM*), the time interval between consecutive peaks

ECG and PPG respectively), are usually not necessary when analysing EHR data since they are often performed by patient monitors prior to signal output. Beat detection was performed in the ECG using a QRS detector based upon the algorithm of Pan, Hamilton and Tompkins [21, 22], and in the PPG using the Incremental-Merge Segmentation (IMS) algorithm [23]. Fiducial points, such as R-waves and pulse-peaks, and Q-waves and pulse troughs, were identified for each beat. Three feature measurements were then extracted from these fiducial points on both the ECG and PPG waveforms as illustrated in Fig. 26.6. The three beat-by-beat time series of feature measurements are sampled irregularly since there is one measurement per heart beat. Since frequency domain analysis requires regularly sampled signals, these signals were resampled at a regular frequency of 5 Hz using linear interpolation. Finally, spurious non-respiratory frequencies introduced in the extraction process were eliminated using band-pass filtering within the range of plausible respiratory frequencies (4–60 bpm). Spurious high frequencies arise due to linear interpolation and spurious low frequencies can be caused by physiological changes.



RR estimation from the ECG and PPG was performed in both the frequency and time domain using the Fourier analysis and breathing cycle detection techniques used to estimate the reference RRs. An additional quality assessment and fusion step, the “Smart Fusion” method [19], was optionally performed in an attempt to increase the accuracy of RR estimates. The first step of “Smart Fusion” is to assess the quality of the RR estimates derived from the three modulations. If the three estimates are within 4 bpm of each other, then a final RR estimate is generated as the mean of the estimates. Otherwise, no output is provided.

## 26.5 Results

Table 26.2 shows the mean absolute error (MAE) for all methods under analysis. The most accurate algorithm prior to implementing quality assessment and fusion steps had a MAE of 4.28 bpm. This algorithm extracted BW from the PPG and estimated RR using breath detection. Algorithms using BW respiratory signals outperformed those using AM, which in turn outperformed FM algorithms. Furthermore, those using breath detection to estimate RR outperformed those using Fourier analysis.

An improvement in accuracy was observed when the additional quality assessment and fusion step was added to breath detection algorithms. The MAEs for the ECG and PPG decreased from 4.87 to 3.92 bpm, and from 4.28 to 3.36 bpm respectively. This was achieved at the expense of the number of windows from which RRs were estimated. When using this additional step 44 % of ECG windows and 63 % of PPG windows were discarded by the quality assessment. Interestingly, no improvement in accuracy was observed when adding these steps to a Fourier-based algorithm.

It should be noted that a substantial proportion of the data available for analysis was discarded prior to analysis. A reference RR could only be obtained from 10 % of windows. In addition, 44 % of ECG windows, and 30 % of PPG windows were

**Table 26.2** The performances of the algorithms applied to the ECG and PPG, measured using the mean absolute error (MAE, measured in breaths per minute, bpm)

Algorithm specification		MAE (bpm)	
Respiratory signal	RR estimation	ECG	PPG
BW	Breath detection	4.87	4.28
AM	Breath detection	4.95	5.58
FM	Breath detection	8.48	7.95
BW	Fourier	7.51	8.18
AM	Fourier	8.69	11.14
FM	Fourier	13.16	12.11
BW, AM, FM	Breath detection + quality assess + fusion	3.92	3.36
BW, AM, FM	Fourier + quality assess + fusion	12.66	10.52

discarded due to low signal quality, likely indicating the presence of movement artifact or sensor disconnection. Consequently, only 6 % of the ECG data, and 7 % of the PPG data were included in the analysis.

## 26.6 Discussion

RR is widely used in a range of clinical settings to aid diagnosis and prognosis. Despite its clinical importance, it is the only vital sign which is not routinely measured electronically outside of Critical Care. In this case study techniques have been presented for the estimation of RR from two easily and routinely measured physiological signals, the ECG and PPG. There were two important findings. Firstly, the addition of a signal quality and fusion step to the breath-detection algorithms increased accuracy. Secondly, time-domain breath-detection algorithms outperformed the frequency-domain algorithms. This suggests that further research is warranted into time-domain methods, which are far less reliant on the RR being quasi-stationary. If a method is found to perform sufficiently well then it could be used to measure RR during routine physiological assessments to provide early warning of clinical deteriorations.

The dataset used in this case study is a useful resource for further testing of RR algorithms. Its strength is that it contains waveform data from thousands of critically-ill patients, with many datasets lasting hours or days. However, the generalisability of the results is limited by the consisting solely of critically-ill patients. This is particularly significant considering that RR algorithms would most often be used with patients outside of Critical Care. Furthermore, the IP signal gave a reliable reference RR for only 10 % of the time. This resulted in a low number of signal windows being included in the analysis, a significant limitation. Consequently, this case study should be treated as an example of the methodology which could be used to perform a robust study, rather than as a robust study itself. In addition, some uncertainty remained in the reference RRs since they are the mean of two estimates which could differ by up to 2 bpm. When testing algorithms for extraction of clinical parameters from physiological signals, the more accurate the reference value, the better. In this study the measured MAEs are likely to be higher than the true MAEs of the algorithms because of inaccuracies in the reference RR.

A key challenge of waveform analysis is the handling of low quality data. One approach is to detect and exclude low quality data, as performed using the quality assessment and fusion step in this study. A simple template-matching SQI was used here. More complex techniques which fuse the results of multiple SQIs to determine signal quality may improve the performance of RR algorithms in clinical practice [24, 25]. An alternative approach is to refine analysis techniques to ensure they remain accurate even when using low quality data. For instance, in [26] an algorithm is presented for estimation of RR from the ECG during exercise, when the signal is likely to be of low quality.

## 26.7 Conclusions

This case study demonstrates the potential utility of the ECG and PPG for measurement of RR in the clinical setting. The necessary tools required to design and test RR algorithms are presented, allowing the interested reader to extend this work. The results suggest two particular areas for further algorithmic development. Firstly, the use of signal quality and fusion to improve the accuracy of RR algorithms should be explored further. In the literature much focus has been given to the extraction of respiratory signals and estimation of RR, whereas relatively little research has been conducted into quality assessment and fusion. Secondly, further research should be conducted into the use of time-domain techniques to identify individual breathing cycles. It is notable that in this study the time-domain technique outperformed the frequency-domain technique, whilst in the literature reported time-domain techniques are rarely more sophisticated than peak detection. However, the low data inclusion rate in this study suggests that further investigation is required to ensure that conclusions are robust.

## 26.8 Further Work

There are two pressing research questions concerning estimation of RR from physiological signals. Firstly, it is not clear which RR algorithm is the most accurate. Until recently validation studies had compared only a few of the many existing algorithms. Comparison between studies is difficult since studies are usually performed on different datasets collected from different populations, using different statistical measures. A recent study evaluated many algorithms on data acquired from young, healthy subjects. Secondly, it is not clear whether the most accurate algorithm performs well enough for clinical use.

Further studies are required to answer such questions. We propose that algorithms should be tested firstly in a healthy population, in ideal operating conditions. This would facilitate assessment of the best possible performance of the algorithms. If any algorithms perform sufficiently well for clinical use, then they could be tested in patient populations in clinical settings. Conversely, if no algorithms perform adequately, then further algorithmic development should be carried out to attempt to improve the performance. The MIMIC II database provides opportunity to test algorithms in a wide range of physiological conditions, such as hyper- and hypotension, and normal and reduced ejection fraction. This may provide insight into the limitations of the algorithms, ensuring that they are only used when in conditions in which they can be expected to perform well.

## 26.9 Non-contact Vital Sign Estimation

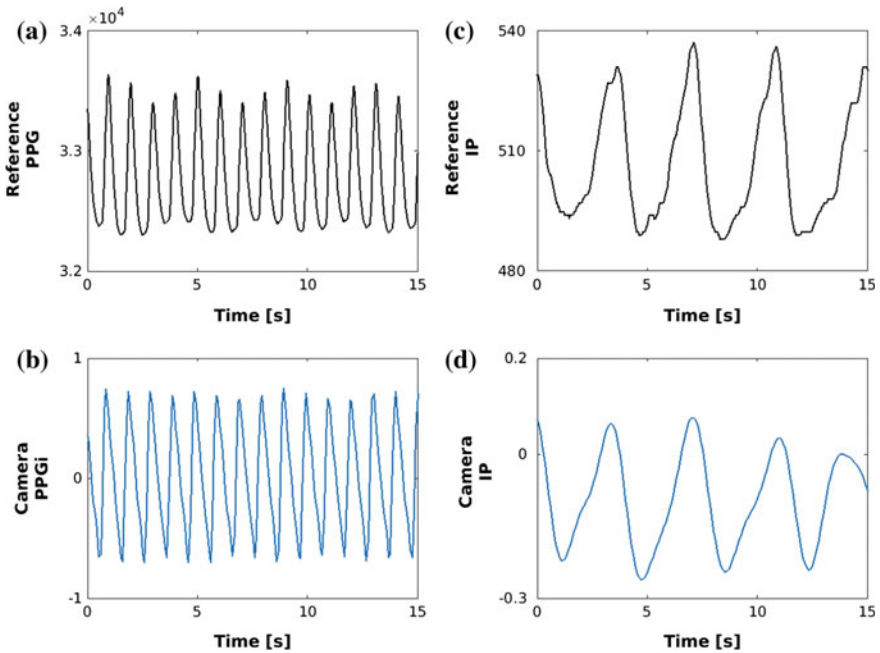
As presented in this chapter, current monitoring systems available to track changes in the vital signs of patients in the clinic or at home require contact with the subject. Most patients requiring regular monitoring find the probes difficult to attach and use properly [28]. The process of recording vital signs, even if it only takes a few minutes, becomes burdensome as it usually has to be performed on a daily basis. The low compliance of patients with wearing sensors is also an obstacle to successful monitoring.

The ideal technology to estimate vital signs would involve sensors with no direct contact with the patient, providing several advantages over traditional methods because no subject participation is required to set the equipment up, it requires no skin preparation, causes no skin irritation, decreases the risk of infection, and has the potential to be seamlessly integrated into the patient's lifestyle.

Several technologies have been proposed for non-contact monitoring of vital signs from Radar-based systems to non-contact ECG using capacitive coupling electrodes. During the last decade, with the cost of digital video cameras continuing to decrease as the technology becomes more ubiquitous, research in non-contact vital sign monitoring has expanded through the use of off-the-shelf video cameras. Video cameras can be found in laptops, mobile phones, set-top boxes and television sets in patients' living room, opening up new possibilities for the monitoring of vital signs.

Video-based vital sign monitoring extends the concepts of traditional photoplethysmography using the multiple photosites present in an imaging sensor to record the blood volume changes associated with the cardiac cycle. These physiological changes result in a waveform known as photoplethysmographic imaging (PPGi), from which vital signals such as heart rate, respiratory rate, oxygen saturation ( $\text{SpO}_2$ ) and other can be estimated [11, 29]. Figure 26.7 shows a 15-s sample of PPGi alongside PPG and IP signals measured using conventional monitoring equipment. The patient was undergoing haemodialysis treatment at the Churchill Hospital in Oxford. During this period the patient had a heart rate of 60 beats/min and a respiratory rate of 15 bpm, both of which can be computed from both the conventional monitoring equipment and the camera using the methods explained in this chapter.

Decades of extensive research from the computer vision community have helped to develop imaging systems that are capable of complex computations (such as face detection, identity access control or other object tracking), are interactive (such as motion/gesture and body tracking in games) and can perform complex 3D reconstruction operations. Therefore, video-based vital sign monitoring has the potential to expand the role vital sign monitoring beyond that which can be met by traditional pulse oximetry.



**Fig. 26.7** A 15-s sample of data from a patient undergoing haemodialysis treatment at the Churchill Hospital in Oxford. **a** Reference PPG waveform from a Nonin pulse oximeter, **b** extracted photoplethysmographic imaging (PPGi) waveform from a video camera, **c** reference impedance pneumography (IP) respiratory signal, **d** respiratory signal extracted from the PPGi waveform. During the period the patient had a heart rate of 60 beats/min and a respiratory rate of 15 breaths per minute (bpm)

**Open Access** This chapter is distributed under the terms of the Creative Commons Attribution-NonCommercial 4.0 International License (<http://creativecommons.org/licenses/by-nc/4.0/>), which permits any noncommercial use, duplication, adaptation, distribution and reproduction in any medium or format, as long as you give appropriate credit to the original author(s) and the source, a link is provided to the Creative Commons license and any changes made are indicated.

The images or other third party material in this chapter are included in the work's Creative Commons license, unless indicated otherwise in the credit line; if such material is not included in the work's Creative Commons license and the respective action is not permitted by statutory regulation, users will need to obtain permission from the license holder to duplicate, adapt or reproduce the material.

## Code Appendix

The code used in this case study is available from the GitHub repository accompanying this book: <https://github.com/MIT-LCP/critical-data-book>. Further information on the code is available from this website. The following key scripts were used:

- `MIMICII_data_importer.m`: used to extract data from the MIMIC II database.
- `RRest.m`: used to run RR algorithms and assess their performances.

## References

1. Shann F, Hart K, Thomas D (1984) Acute lower respiratory tract infections in children: possible criteria for selection of patients for antibiotic therapy and hospital admission. *Bull World Health Organ* 62(5):749
2. Lim WS, Van der Eerden MM, Laing R, Boersma WG, Karalus N, Town GI, Lewis SA, Macfarlane JT (2003) Defining community acquired pneumonia severity on presentation to hospital: an international derivation and validation study. *Thorax* 58(5):377–382
3. Pollack MM, Ruttimann UE, Getson PR (1988) Pediatric risk of mortality (prism) score. *Crit Care Med* 16(11):1110–1116
4. World Health Organization (WHO) (1990) Fourth Programme Report, 1988–1989: ARI Programme for Control of Acute Respiratory Infections. Technical Report, WHO, Geneva
5. Lovett PB, Buchwald JM, Stürmann K, Bijur P (2005) The vexatious vital: neither clinical measurements by nurses nor an electronic monitor provides accurate measurements of respiratory rate in triage. *Ann Emerg Med* 45(1):68–76
6. Chellel A, Fraser J, Fender V, Higgs D, Buras-Rees S, Hook L, Mummery L, Cook C, Parsons S, Thomas C (2002) Nursing observations on ward patients at risk of critical illness. *Nurs Times* 98(46):36–39
7. Cretikos MA, Bellomo R, Hillman K, Chen J, Finfer S, Flabouris A (2008) Respiratory rate: the neglected vital sign. *Med J Aust* 188(16):657–659
8. Hogan J (2006) Why don't nurses monitor the respiratory rates of patients? *Br J Nurs* 15(9):489–492
9. Meredith DJ, Clifton D, Charlton P, Brooks J, Pugh CW, Tarassenko L (2012) Photoplethysmographic derivation of respiratory rate: a review of relevant physiology. *J Med Eng Technol* 36(1):1–7
10. Bailon R, Sornmo L, Laguna P (2006) ECG-derived respiratory frequency estimation. In: *Advanced methods and tools for ECG data analysis* (Chap. 8). Artech House, London, pp 215–244
11. Tarassenko L, Villarroel M, Guazzi A, Jorge J, Clifton DA, Pugh C (2014) Non-contact video-based vital sign monitoring using ambient light and auto-regressive models. *Physiol Meas* 35(5):807–831
12. Garde A, Karlen W, Ansermino JM, Dumont GA (2014) Estimating respiratory and heart rates from the correntropy spectral density of the photoplethysmogram. *PLoS ONE* 9(1): e86427
13. Goldberger AL, Amaral LA, Glass L, Hausdorff JM, Ivanov PC, Mark RG, Mietus JE, Moody GB, Peng CK, Stanley HE (2000) Physiobank, physiotoolkit, and physionet components of a new research resource for complex physiologic signals. *Circulation* 101(23): E215–E220
14. Saeed M, Villarroel M, Reisner AT, Clifford G, Lehman L, Moody G, Heldt T, Kyaw TH, Moody B, Mark RG (2011) Multiparameter intelligent monitoring in intensive care II: a public-access intensive care unit database. *Crit Care Med* 39(5):952–960
15. Fleming S, Thompson M, Stevens R, Heneghan C, Plüddemann A, Maconochie I, Tarassenko L, Mant D (2011) Normal ranges of heart rate and respiratory rate in children from birth to 18 years of age: a systematic review of observational studies. *Lancet* 377(9770):1011–1018

16. Nizami S, Green JR, McGregor C (2013) Implementation of artifact detection in critical care: a methodological review. *IEEE Rev Biomed Eng* 6:127–142
17. Orphanidou C, Bonnici T, Charlton P, Clifton D, Vallance D, Tarassenko L (2015) Signal-quality indices for the electrocardiogram and photoplethysmogram: derivation and applications to wireless monitoring. *IEEE J Biomed Health Inform* 19(3):832–838
18. Pimentel MAF, Charlton PH, Clifton DA (2015) Probabilistic estimation of respiratory rate from wearable sensors. In: Mukhopadhyay SC (ed) *Wearable electronics sensors*, vol 15. Springer International Publishing, pp 241–262
19. Karlen W, Raman S, Ansermino JM, Dumont GA (2013) Multiparameter respiratory rate estimation from the photoplethysmogram. *IEEE Trans Biomed Eng* 60(7):1946–1953
20. Schäfer A, Kratky KW (2008) Estimation of breathing rate from respiratory sinus arrhythmia: comparison of various methods. *Ann Biomed Eng* 36(3):476–485
21. Pan J, Tompkins WJ (1985) A real-time QRS detection algorithm. *IEEE Trans Biomed Eng* 32(3):230–236
22. Hamilton PS, Tompkins WJ (1986) Quantitative investigation of QRS detection rules using the MIT/BIH arrhythmia database. *IEEE Trans Biomed Eng* 33(12):1157–1165
23. Karlen W, Ansermino JM, Dumont G (2012) Adaptive pulse segmentation and artifact detection in photoplethysmography for mobile applications. In: *Proceedings of the annual international conference of the IEEE engineering in medicine and biology society*, vol 2012. EMBS, pp 3131–3134
24. Behar J, Oster J, Li Q, Clifford GD (2013) ECG signal quality during arrhythmia and its application to false alarm reduction. *IEEE Trans Biomed Eng* 60(6):1660–1666
25. Li Q, Clifford GD (2012) Dynamic time warping and machine learning for signal quality assessment of pulsatile signals. *Physiol Meas* 33(9):1491–1501
26. Bailón R, Sömö L, Laguna P (2006) A robust method for ECG-based estimation of the respiratory frequency during stress testing. *IEEE Trans Biomed Eng* 53(7):1273–1285
27. Charlton PH, Bonnici T, Tarassenko L, Clifton DA, Beale R, Watkinson PJ (2016) An assessment of algorithms to estimate respiratory rate from the electrocardiogram and photoplethysmogram. *Physiol Measur* 37(4): 610–626
28. Bonnici T, Orphanidou C, Vallance D, Darrell A, Tarassenko L (2012) Testing of wearable monitors in a real-world hospital environment: what lessons can be learnt? In: *2012 ninth international conference on wearable and implantable body sensor networks*, pp 79–84
29. Villarroel M, Guazzi A, Jorge J, Davis S, Watkinson P, Green G, Shenvi A, McCormick K, Tarassenko L (2014) Continuous non-contact vital sign monitoring in neonatal intensive care unit. *Healthc Technol Lett* 1(3):87–91
30. Addison PS, Watson JN, Mestek ML, Mecca RS (2012) Developing an algorithm for pulse oximetry derived respiratory rate (RR(oxi)): a healthy volunteer study. *J Clin Monit Comput* 26(1):45–51

# Chapter 27

## Signal Processing: False Alarm Reduction

Qiao Li and Gari D. Clifford

### Learning Objectives

Use a data fusion and machine learning approach to suppress false arrhythmia alarms.

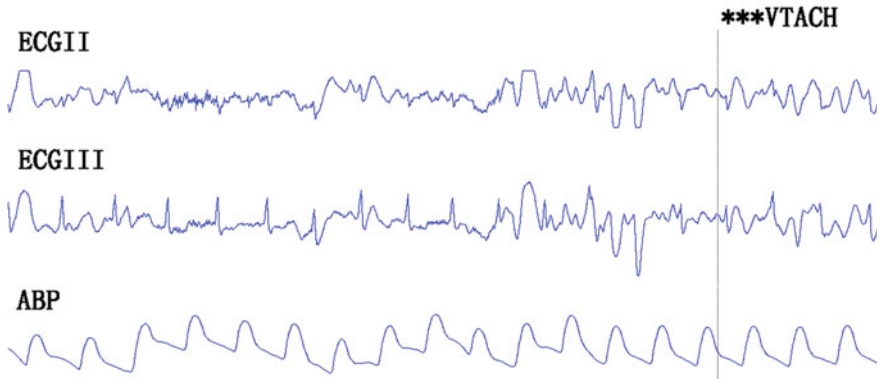
This case study introduces concepts that should improve understanding of the following:

1. Extract relevant features from clinical waveforms.
2. Assess signal quality of clinical data, and
3. Develop a machine learning model, train and validate it using a clinical database.

### 27.1 Introduction

Modern patient monitoring systems in intensive care produce frequent false alarms which lead to a disruption of care, impacting both the patient and the clinical staff through noise disturbances, desensitization to warnings and slowing of response times [1, 2]. This leads to decreased quality of care [3, 4], sleep deprivation [1, 5, 6], disrupted sleep structure [7, 8], stress for both patients and staff [9–12] and depressed immune systems [13]. Intensive care unit (ICU) false alarm rates as high as 90 % have been reported [14], while only 8 % of alarms were determined to be true alarms with clinical significance [15] and over 94 % of alarms may not be clinically important [16]. There are two main reasons for the high false alarm rate. One is that physiological data can be severely corrupted by artifacts (e.g. from movement), noise (e.g. from electrical interference) and missing data (e.g. from transducer ‘pop’ leading to impedance or pressure changes and a resultant signal saturation). Figure 27.1 illustrates the bedside monitor ‘waveforms’ (or high resolution data)





**Fig. 27.1** False ventricular tachycardia alarm, ‘called’ at the point where the vertical line is placed in a 30 s snapshot of two leads of ECG (ECGII an ECGIII) and an arterial blood pressure signal (*ABP*). The alarm is triggered by the strong noise manifesting as high amplitude ( $\pm 2$  mV) oscillations on the ECG at approximately 5 Hz beginning a little over halfway through the snapshot (and a little under 10 s from the vertical VT marker). Note that the *ABP* continues as normal, with no significant change in rhythm or morphology

recorded around a false ventricular tachycardia alarm (the vertical line indicates the moment at which the monitor triggered the alarm). The alarm is caused by significant noise affecting the electrocardiogram (ECG) leads. However, the regular pulsatile beats present in the arterial blood pressure (*ABP*) lead clearly indicate this is a false alarm (since the poor pump function during this arrhythmia should cause a significant drop in pulse amplitude and an increase in rate). The other reason for the high rate of false alarms is that univariate alarm algorithms and simple numeric thresholds are predominantly used in current clinical bedside monitors. The reason for this is an historical artifact, in that manufacturers have developed different embedded systems with bespoke hardware and single mode transducers. Univariate alarm-detection algorithms therefore consider a single monitored waveform at a time. The alarm is generally triggered when a variable (e.g. heart rate) derived from the waveform (e.g. ECG) is above or below a preset (or adjustable) threshold for a given length of time, regardless of whether the change is caused by a change in physiological state, by an artifact or by medical interventions, such as moving or positioning the patient, drawing blood and flushing the arterial line, or disconnecting the patient from the ventilator for endotracheal suctioning. Moreover, alarm thresholds are often adjusted in an ad hoc manner, based on how annoying the alarm is perceived to be by the clinical team in attendance. There is little evidence that alarm thresholds are optimized for any population or individual, particularly in a multivariate sense.

Various noise cancellation algorithms such as median filtering [17] or Kalman filtering [18] have been used to suppress false alarms. While transient noise can be removed by median filtering it is brutally non-adaptive. Kalman filtering, on the other hand, is an optimal state estimation method, which has been used to improve heart rate (HR) and blood pressure (BP) estimation during noisy periods and

arrhythmias [18]. However, alarm detection has changed little in decades, with the univariate alarm algorithm paradigm persisting. A promising solution to the false alarm issue comes from multiple variable data fusion, such as HR estimation by fusing the information from synchronous ECG, ABP and photoplethysmogram (PPG) from which oxygen saturation is derived [18]. Otero et al. [19] proposed a multivariable fuzzy temporal profile model which described a set of monitoring criteria of temporal evolution of the patient's physiological variables of HR, oxygen saturation (SpO<sub>2</sub>) and BP. Aboukhalil et al. [14] and Deshmane [20] used synchronous ABP and PPG signals to suppress false ECG alarms. Zong et al. [21] reduced false ABP alarms using the relationships between ECG and ABP. Besides calculated physiological parameters, signal quality indices (SQI), which assess the waveform's usefulness or the noise levels of the waveforms, can be extracted from the raw data and used as weighting factors to allow for varying trust levels in the derived parameters. Behar et al. [22] and Li and Clifford [23] suppressed false ECG alarms by assessing the signal quality of ECG, ABP and PPG. Monasterio et al. [24] used a support vector machine to fuse data from respiratory signals, heart rate and oxygen saturation derived from the ECG, PPG, and impedance pneumogram, as well as several SQIs, to reduce false apnoea-related desaturations.

## 27.2 Study Dataset

A dataset drawn from PhysioNet's MIMIC II database [25, 26] was used in this study, containing simultaneous ECG, ABP, and PPG recordings with 4107 multiple expert-annotated life-threatening arrhythmia alarms [asystole (AS), extreme bradycardia (EB), extreme tachycardia (ET) and ventricular tachycardia (VT)] on 182 ICU admissions. A total of 2301 alarms were found by selecting the alarms when the ECG, ABP and PPG were all available. The false alarm rates were 91.2 % for AS, 26.6 % for EB, 14.4 % for ET, and 44.4 % for VT respectively, and 45.0 % overall. The ICU admissions were divided into two separate sets for training and testing, ensuring that the frequency of alarms in each category was roughly equal through frequency ranking and separating odd and evenly numbered signals. Table 27.1 details the relative frequency of each alarm category and their associated true and false alarm rates. The waveform data from 30 s before to 10 s after the alarm were extracted for each alarm to aid expert verification (since the Association for the Advancement of Medical Instrumentation (AAMI) guidelines require an alarm to respond within 10 s of the initiation of any alarm event [27]). A consensus of three experts was required to label each alarm as true or false. Only data from 10 s before the alarm to the alarm onset were used for automated feature extraction and model classification.

Since the VT alarm was considered the most difficult type of false alarm to suppress, with an associated low false alarm reduction rate and high true alarm suppression rate in literature [14, 20–23, 28], we therefore focus on reducing this

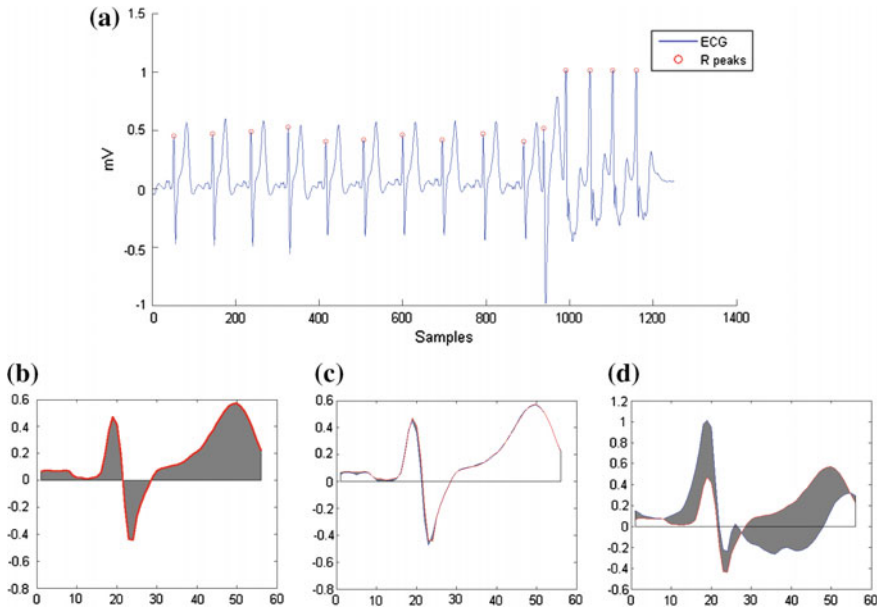
**Table 27.1** Distribution of alarms in the dataset and training and test set

Alarm type	Total				Training set				Test set			
	False	True	Total	FA rate (%)	False	True	Total	FA rate (%)	False	True	Total	FA rate (%)
AS	260	25	285	91.2	166	14	180	92.2	94	11	105	89.5
EB	62	171	233	26.6	58	108	166	34.9	4	63	67	6.0
ET	37	220	257	14.4	19	116	135	14.1	18	104	122	14.8
VT	677	849	1526	44.4	306	478	784	39.0	371	371	742	50.0
All	1036	1265	2301	45.0	549	716	1265	43.4	487	549	1036	47.0

false alarm for the rest of the chapter. Interested readers are directed to Li and Clifford [23] for methods to reduce false alarms on the other types of alarms.

### 27.3 Study Pre-processing

In total 147 features and SQI metrics were extracted from ECG, ABP, PPG, and SpO<sub>2</sub> signals within the 10 s analysis window. These features were generally chosen based upon previous research by the authors and others [14, 20–24, 28–32]. The typical features included HR (extracted from ECG, ABP, and PPG), blood pressure (systolic, diastolic, mean), oxygen saturation (SpO<sub>2</sub>), and the amplitude of PPG. Each feature had five sub-features calculated over the 10 s window: including the minimum, maximum, median, variance, and gradient (derived from a robust least squares fit over the entire window). Besides the typical features, the area difference of beats (ADB), the area ratio of beats (ARB) in the ECG, ABP and PPG and thirteen ventricular fibrillation metrics (taken from [29]) were also extracted. The area of each beat was defined to be the area between the waveform and the x-axis, from the start of the ECG beat to 0.6 times of mean beat-by-beat interval (BBi). Note the start of the ECG beat was taken as the position of R peak—0.2 \* BBi. The ADB was calculated by comparing each beat to the median of the beats in the window, as shown in Fig. 27.2. The ADB used four sub-features; the mean ADB of five beats with the shortest beat-to-beat intervals, the maximum of mean ADB of five consecutive beats, the variance and gradient of ADB. The ARB used five sub-features; the ratio between the mean area of five smallest beats and five largest beats of the ECG (ARB<sub>ECG</sub>), ABP (ARB<sub>ABP</sub>), and PPG (ARB<sub>PPG</sub>), the ratio between ARB<sub>ECG</sub> and ARB<sub>ABP</sub>, and the ratio between ARB<sub>ECG</sub> and ARB<sub>PPG</sub>. The description of the thirteen ventricular fibrillation metrics can be found in Li et al. [29], and included spectral and time domain features shown to allow highly accurate classification of VF. The ECG SQI metrics included thirteen metrics [30], based on standard moments, frequency domain statistics and the agreement between event detectors with different noise sensitivities. The ABP SQI metrics included a signal abnormality index with its nine sub-metrics [31] and a dynamic time warping



**Fig. 27.2** Example of area difference of beats calculation. **a** ECG in a 10 s window. **b** The median beat of the beats in the window (*gray* area shows the area between the waveform and the x-axis). **c** ADB of a normal beat (the first beat, *gray* area shows the ADB). **d** ADB of an abnormal beat (the last beat)

(DTW) based SQI approach with its four sub-metrics [32]. The DTW based SQI resampled each beat to match a running beat template by derived using the DTW. The SQI was then given by the correlation coefficient between the template and each beat. The PPG SQI metrics included the DTW-based SQIs [32] and the first two Hjorth parameters [20] which estimated the dominant frequency and half-bandwidth of the spectral distribution of PPG. While these do not necessarily represent an exhaustive list of features, they do represent the vast majority of features identified as useful in previous studies.

## 27.4 Study Methods

A modified random forests (RF) classifier, previously described by Johnson et al. [33], was used. The RF [34] is an ensemble learning method for classification that constructs a number of decision trees at training time and outputs the class that is the mode of the classes of the individual trees. The basic principle is that a group of “weak learners” can come together to form a “strong learner.” RFs correct for decision trees’ defects of overfitting and adding bias to their training set. Each tree selects a subset of observations via two regression splits. These observations are

then given a contribution equal to a random constant times the observation's value for a chosen feature plus a random intercept. The contributions across all trees are summed to provide the contribution for a single "forest," where a "forest" refers to a group of trees plus an intercept term. The predicted likelihood function output ( $L$ ) by the forest is the inverse logit of the sum of each tree's contribution plus the intercept term (27.1). The intercept term is set to the logit of the mean observed outcome.

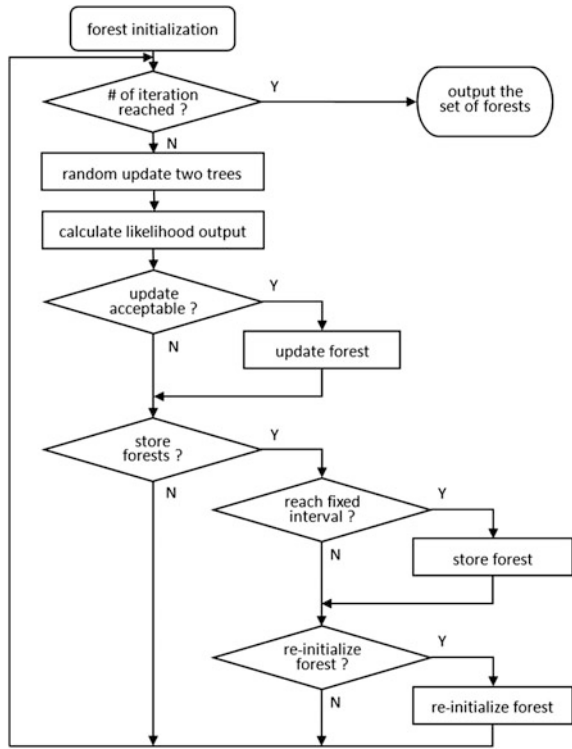
$$L = \sum_{i=1}^N ((-t_i) * \log(\text{logit}^{-1}(s_i)) - (1 - t_i) * \log(1 - \text{logit}^{-1}(s_i))) \quad (27.1)$$

where  $t_i$  is the target of the training set,  $s_i$  is the sum of tree's contribution,  $i = 1 \dots N$  is the number of observations in the training set.

The core of the new RF model we used is the custom Markov chain Monte Carlo (MCMC) sampler that iteratively optimizes the forest. This sampling process constructs the Markov chain by a memoryless iteration process which selects randomly two trees from the current forests and updates their structure. The MCMC randomly samples the observation space by a large user-defined number of bootstrap iterations. After standardizing the training data to a standard normal distribution, the forest is initialized to a null model, with no contributions assigned for any observations.

At each iteration, the algorithm randomly selects two trees in the forest and randomizes their structure. That is, it randomly re-selects first two features which the tree uses for splitting, the value at which the tree splits those features, the third feature used for contribution calculation, and the multiplicative and additive constants applied to the third feature. The total forest contribution is then recalculated and a Metropolis-Hastings acceptance step is used to determine if the update is accepted. The predicted likelihood of the previous forest ( $L_i$ ) and the likelihood of the forest with the two updated trees ( $L_{i+1}$ ) were calculated. If  $e^{(L_i - L_{i+1})}$  is greater than a uniformly distributed random real number within unit interval, the update is accepted. If the update is accepted, the two trees are kept in the forest, otherwise they are discarded and the forest remains unchanged. After a set fraction of the total number of iterations to allow the forest to learn the target distribution (generally 20 %), the algorithm begins storing forests at a fixed interval, i.e. once every set number of iterations. Once the number of user-defined iterations is reached, the forest is re-initialized as before, and the iterative process restarts. Again, after the set burn-in period, the forests begin to be saved at a fixed interval. The final result of this algorithm is a set of forests, each of which will contribute to the final model classification. The flowchart of the RF algorithm is shown in Fig. 27.3.

**Fig. 27.3** The flowchart of the random forests algorithm



### 27.5 Study Analysis

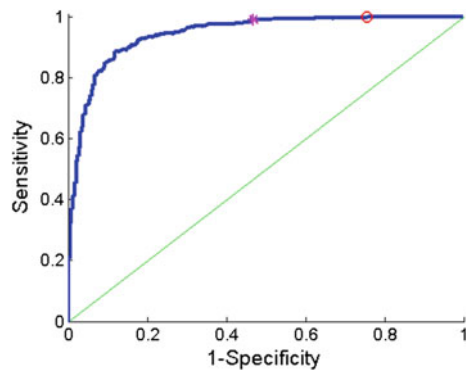
The RF model was optimized on the training set and evaluated for out-of-sample accuracy on the test set. During the training phase, a model of 320 forests with 500 trees in each forest was established. The output of the model provides a probability between 0 and 1, which is an estimated value equivalent to a false or true alarm respectively. The receiver operating characteristic (ROC) curve was extracted by raising the threshold on the probability where we switch from false to true from 0 to 1—i.e. the probability greater than the threshold indicates a true alarm and below (or equal) indicates a false alarm. The optimal operating point was selected at the ROC curve when sensitivity equals 1 (no true alarm suppression) with the largest specificity. However, a sub-optimal operating point was also selected with acceptable sensitivity to balance specificity, e.g. sensitivity equals 99 %. (The reason for this is that anecdotally, clinical experts have indicated a 1 % true alarm suppression rate (or increase in true alarm suppression rate) would be acceptable—see discussion in study conclusions.) The model was then evaluated on the test set with the selected operating points.

In the algorithm validation phase, the classification performance of the algorithm was evaluated using 10-fold cross validation. The process sorted the study dataset into ten folds randomly stratified by ICU admissions rather than by the alarms. Then, nine folds were used for training the model and the last fold was used for validation. This process was repeated ten times as one integral procedure, with each of the folds used exactly once as the validation data. The average performance was used for evaluation. We note however, that this may be suboptimal and a voting of all folds may produce a better performance.

## 27.6 Study Visualizations

The ROC curve on the training set is shown in Fig. 27.4. The optimal operating point (marked by a circle) shows sensitivity 100.0 % and specificity 24.5 %, indicating we suppress 24.5 % of the false alarms without true alarm suppression. The sub-optimal operating point (marked by a star) shows a sensitivity 99.2 % and specificity 53.3 %, indicating a false alarm reduction of 53.3 % with only a 0.8 % true alarm suppression rate. When the model was used on the test set by the optimal

**Fig. 27.4** ROC curve for the training set. *Circle* indicates optimal operating point (in terms of clinical acceptability) and *star* a sub-optimal operating point which may in fact be preferable



**Table 27.2** Result of 10-fold cross validation of the classification model with different operating points

Operating point (by sensitivity) (%)	Training (on 9 folds)		Validation (on 1 held out fold)	
	Sensitivity (%)	Specificity (%)	Sensitivity (%)	Specificity (%)
99.00	99.06 ± 0.04	56.41 ± 5.60	95.82 ± 5.62	51.68 ± 16.88
99.50	99.56 ± 0.04	49.08 ± 5.37	96.50 ± 5.39	45.19 ± 17.94
99.60	99.66 ± 0.04	43.49 ± 6.45	98.72 ± 2.06	38.14 ± 17.25
99.70	99.75 ± 0.03	39.50 ± 7.39	98.75 ± 2.08	32.07 ± 16.19
99.80	99.87 ± 0.02	34.57 ± 9.02	98.87 ± 2.11	28.16 ± 15.80
100.0	100.0 ± 0.00	27.85 ± 6.17	99.04 ± 2.02	18.10 ± 9.87

operating point, a sensitivity of 99.7 % and a specificity of 17.0 % were achieved, with a sensitivity of 99.5 % and a specificity of 44.2 % for the sub-optimal operating point. The result of 10-fold cross validation with different options of operating points is shown in Table 27.2.

## 27.7 Study Conclusions

We show here that a promising approach to suppression of false alarms appears to be through the use of multivariate algorithms, which fuse synchronous data sources and estimates of underlying quality to make a decision. False VT alarms are the most difficult to suppress without causing any true alarm suppression since the ABP and PPG waveforms may have morphology changes indicating the hemodynamics changes during VT. We also show that a random forests-based model can be implemented with high confidence that few true alarms would be suppressed (although it's impossible to say 'never'). A practical operating point can be selected by changing the threshold of the model in order to balance the sensitivity and specificity. We note that the best previously reported results on VT alarms were by Aboukhalil et al. [14] and Sayadi and Shamsollahi [28] who achieved false VT alarm suppression rates of 33.0 and 66.7 % respectively. However, the TA suppression rates they achieved (9.4 and 3.8 % respectively) are clearly too high to make their algorithms acceptable for this category of alarm. Compared with our previous studies using some common machine learning algorithms such as support vector machine [22] and relevance vector machine [23], the random forests algorithm, which fused the features extracted from synchronous data sources like ECG, ABP and PPG, provided lower TA suppression rates and higher FA suppression rates. Moreover, a systematic validation procedure, such as k-fold cross validation, is necessary to evaluate the algorithm and we note that earlier works did not follow such a protocol. Without such validation, it is hard to believe that the algorithm will work well on unseen data because of overfitting. This is extremely important to note, that even a 0 % true alarm suppression is unlikely to always hold, and so a small true alarm suppression is likely to be acceptable. In private discussions with our clinical advisors, a figure of 1 % has often been suggested. In the work presented here, we show that with just half a percent of true alarms being suppressed, almost half of the false alarms can be suppressed. This true alarm suppression rate is likely to be negligible compared to the actual number of noise-induced missed alarms from the bedside monitor itself. (No monitor is perfect, and false negative rates of between 0.5 and 5 % have been reported [35].) We also note that the algorithm proposed here used 10 s of data before the alarm only, which meets the 10 s requirement of AAMI standard [27]. In recent work from the PhysioNet/Computing in Cardiology Challenge 2015, it was shown that extending this window slightly can lead to significant improvements in false alarm suppression [36]. Although the regulatory bodies would need to approve such changes, and that is often seen as unlikely, we do note that the 10 s rule is somewhat arbitrary



and such work may indeed influence the changes in regulatory acceptance. We note several limitations to our study. First, the number of alarms is still relatively low, and they come from a single database/manufacturer. Second, medical history, demographics, and other medical data were not available and therefore used to adjust thresholds. Finally, information concerning repeated alarms was not used to adjust false alarm suppression dynamically based on earlier alarm frequency during the same ICU stay. This latter point is particularly tricky, since using earlier alarm data as prior information can be entirely misleading when false alarm rates are non-negligible.

## 27.8 Next Steps/Potential Follow-Up Studies

The issue of false alarms has disturbed the clinical patient monitoring and monitor manufacturers for many years, but the alarm handling has not seen the same progress as the rest of medical monitoring technology. One important reason is that in the current legal and regulatory environment, it may be argued that manufacturers have external pressures to provide the most sensitive alarm algorithms, such that no critical event goes undetected [4]. Equally, one could argue that clinicians also have an imperative to ensure that no critical alarm goes undetected, and are willing to accept large numbers of false alarms to avoid a single missed event. A large number of algorithms and methods have emerged in this area [4, 14, 17–24, 28, 37, 38]. However, most of these approaches are still in an experimental stage and there is still a long way to go before the algorithms are ready for clinical application.

The 2015 PhysioNet/Computing in Cardiology Challenge aimed to encourage the development of algorithms to reduce the incidence of false alarms in ICU [36]. Bedside monitor data leading up to a total of 1250 life-threatening arrhythmia alarms recorded from three of the most prevalent intensive care monitor manufacturers' bedside units were used in this challenge. Such challenges are likely to stimulate renewed interest by the monitoring industry in the false alarm problem. Moreover, the engagement of the scientific community will draw out other subtle issues. Perhaps the three key issues remaining to be addressed are: (1) Just how many alarms should be annotated and by how many experts? (see Zhu et al. [39] for a detailed discussion of this point); (2) How should we deal with repeated alarms, passing information forward from one alarm to the next?; and (3) What additional data should be supplied to the bedside monitor as prior information on the alarm? This could include a history of tachycardia, hypertension, drug dosing, interventions and other related information including acuity scores. Finally, we note that life threatening alarms are far less frequent than other less critical alarms, and by far the largest contributor to the alarm pollution in critical care comes from these more pedestrian alarms. A systematic approach to these less urgent alarms is also needed, borrowing from the framework presented here. More promisingly, the tolerance of true alarm suppression is likely to be much higher for less important alarms, and so we expect to see very large false alarm suppression rates. This is particularly

important, since the techniques described here are general and could apply to most non-critical false alarms, which constitute the majority of such events in the ICU. Although the competition does not directly address these four points (and in fact the data needed to do so remains to become available in large numbers), the competition will provide a stimulus for such discussions and the tools (data and code) will help continue the evolution of the field.

**Open Access** This chapter is distributed under the terms of the Creative Commons Attribution-NonCommercial 4.0 International License (<http://creativecommons.org/licenses/by-nc/4.0/>), which permits any noncommercial use, duplication, adaptation, distribution and reproduction in any medium or format, as long as you give appropriate credit to the original author(s) and the source, a link is provided to the Creative Commons license and any changes made are indicated.

The images or other third party material in this chapter are included in the work's Creative Commons license, unless indicated otherwise in the credit line; if such material is not included in the work's Creative Commons license and the respective action is not permitted by statutory regulation, users will need to obtain permission from the license holder to duplicate, adapt or reproduce the material.

## References

1. Chambrin MC (2001) Review: alarms in the intensive care unit: how can the number of false alarms be reduced? *Crit Care* 5(4):184–188
2. Cvach M (2012) Monitor alarm fatigue, an integrative review. *Biomed Inst Tech* 46(4):268–277
3. Donchin Y, Seagull FJ (2002) The hostile environment of the intensive care unit. *Curr Opin Crit Care* 8(4):316–320
4. Imhoff M, Kuhls S (2006) Alarm algorithms in critical care monitoring. *Anesth Analg* 102(5):1525–1537
5. Meyer TJ, Eveloff SE, Bauer MS, Schwartz WA, Hill NS, Millman RP (1994) Adverse environmental conditions in the respiratory and medical ICU settings. *Chest* 105(4):1211–1216
6. Parthasarathy S, Tobin MJ (2004) Sleep in the intensive care unit. *Intensive Care Med* 30(2):197–206
7. Johnson AN (2001) Neonatal response to control of noise inside the incubator. *Pediatr Nurs* 27(6):600–605
8. Slevin M, Farrington N, Duffy G, Daly L, Murphy JF (2000) Altering the NICU and measuring infants' responses. *Acta Paediatr* 89(5):577–581
9. Cropp AJ, Woods LA, Raney D, Bredle DL (1994) Name that tone. The proliferation of alarms in the intensive care unit. *Chest* 105(4):1217–1220
10. Novaes MA, Aronovich A, Ferraz MB, Knobel E (1997) Stressors in ICU: patients' evaluation. *Intensive Care Med* 23(12):1282–1285
11. Topf M, Thompson S (2001) Interactive relationships between hospital patients' noise induced stress and other stress with sleep. *Heart Lung* 30(4):237–243
12. Morrison WE, Haas EC, Shaffner DH, Garrett ES, Fackler JC (2003) Noise, stress, and annoyance in a pediatric intensive care unit. *Crit Care Med* 31(1):113–119
13. Berg S (2001) Impact of reduced reverberation time on sound-induced arousals during sleep. *Sleep* 24(3):289–292

14. Aboukhalil A, Nielsen L, Saeed M, Mark RG, Clifford GD (2008) Reducing false alarm rates for critical arrhythmias using the arterial blood pressure waveform. *J Biomed Inform* 41(3):442–451
15. Tsien CL, Fackler JC (1997) Poor prognosis for existing monitors in the intensive care unit. *Crit Care Med* 25(4):614–619
16. Lawless ST (1994) Crying wolf: false alarms in a pediatric intensive care unit. *Crit Care Med* 22(6):981–985
17. Mäkivirta A, Koski E, Kari A, Sukuvaara T (1991) The median filter as a preprocessor for a patient monitor limit alarm system in intensive care. *Comput Meth Prog Biomed* 34(2–3):139–144
18. Li Q, Mark RG, Clifford GD (2008) Robust heart rate estimation from multiple asynchronous noisy sources using signal quality indices and a Kalman filter. *Physiol Meas* 29(1):15–32
19. Otero A, Felix P, Barro S, Palacios F (2009) Addressing the flaws of current critical alarms: a fuzzy constraint satisfaction approach. *Artif Intell Med* 47(3):219–238
20. Deshmane AV (2009) False arrhythmia alarm suppression using ECG, ABP, and photoplethysmogram. M.S. thesis, MIT, USA
21. Zong W, Moody GB, Mark RG (2004) Reduction of false arterial blood pressure alarms using signal quality assessment and relationships between the electrocardiogram and arterial blood pressure. *Med Biol Eng Comput* 42(5):698–706
22. Behar J, Oster J, Li Q, Clifford GD (2013) ECG signal quality during arrhythmia and its application to false alarm reduction. *IEEE Trans Biomed Eng* 60(6):1660–1666
23. Li Q, Clifford GD (2012) Signal quality and data fusion for false alarm reduction in the intensive care unit. *J Electrocardiol* 45(6):596–603
24. Monasterio V, Burgess F, Clifford GD (2012) Robust classification of neonatal apnoea-related desaturations. *Physiol Meas* 33(9):1503–1516
25. Goldberger AL, Amaral LAN, Glass L, Hausdorff JM, Ivanov PCh, Mark RG, Mietus JE, Moody GB, Peng C-K, Stanley HE (2000) Physiobank, physiotoolkit, and physionet: components of a new research resource for complex physiologic signals. *Circulation* 101(23):e215–e220
26. Saeed M, Villarroel M, Reisner AT, Clifford G, Lehman L, Moody G, Heldt T, Kyaw TH, Moody B, Mark RG (2011) Multiparameter intelligent monitoring in intensive care II (MIMIC-II): a public-access intensive care unit database. *Crit Care Med* 39(5):952–960
27. American National Standard (ANSI/AAMI EC13:2002) (2002) Cardiac monitors, heart rate meters, and alarms. Association for the Advancement of Medical Instrumentation, Arlington, VA
28. Sayadi O, Shamsollahi M (2011) Life-threatening arrhythmia verification in ICU patients using the joint cardiovascular dynamical model and a Bayesian filter. *IEEE Trans Biomed Eng* 58(10):2748–2757
29. Li Q, Rajagopalan C, Clifford GD (2014) Ventricular fibrillation and tachycardia classification using a machine learning approach. *IEEE Trans Biomed Eng* 61(6):1607–1613
30. Li Q, Rajagopalan C, Clifford GD (2014) A machine learning approach to multi-level ECG signal quality classification. *Comput Meth Prog Biomed* 117(3):435–447
31. Sun JX, Reisner AT, Mark RG (2006) A signal abnormality index for arterial blood pressure waveforms. *Comput Cardiol* 33:13–16
32. Li Q, Clifford GD (2012) Dynamic time warping and machine learning for signal quality assessment of pulsatile signals. *Physiol Meas* 33(9):1491–1501
33. Johnson AEW, Dunkley N, Mayaud L, Tsanas A, Kramer AA, Clifford GD (2012) Patient specific predictions in the intensive care unit using a Bayesian ensemble. *Comput Cardiol* 39:249–252
34. Breiman L (2001) Random forests. *Mach Learn* 45(1):5–32
35. Schapira RM, Van Ruiswyk J (2002) Reduction in alarm frequency with a fusion algorithm for processing monitor signals. Meeting of the American Thoracic Society. Session A56, Poster H57

36. Clifford GD, Silva I, Moody B, Li Q, Kella D, Shahin A, Kooistra T, Perry D, Mark RG (2006) The PhysioNet/computing in cardiology challenge 2015: reducing false arrhythmia alarms in the ICU. *Comput Cardiol* 42:1–4
37. Borowski M, Siebig S, Wrede C, Imhoff M (2011) Reducing false alarms of intensive care online-monitoring systems: an evaluation of two signal extraction algorithms. *Comput Meth Prog Biomed* 2011:143480
38. Li Q, Mark RG, Clifford GD (2009) Artificial arterial blood pressure artifact models and an evaluation of a robust blood pressure and heart rate estimator. *Biomed Eng Online* 8:13
39. Zhu T, Johnson AEW, Behar J, Clifford GD (2014) Crowd-sourced annotation of ECG signals using contextual information. *Ann Biomed Eng* 42(4):871–884

# Chapter 28

## Improving Patient Cohort Identification Using Natural Language Processing

Raymond Francis Sarmiento and Franck Dernoncourt

### Learning Objectives

To compare and evaluate the performance of the structured data extraction method and the natural language processing (NLP) method when identifying patient cohorts using the Medical Information Mart for Intensive Care (MIMIC-III) database.

1. To identify a specific patient cohort from the MIMIC-III database by searching the structured data tables using ICD-9 diagnosis and procedure codes.
2. To identify a specific patient cohort from the MIMIC-III database by searching the unstructured, free text data contained in the clinical notes using a clinical NLP tool that leverages negation detection and the Unified Medical Language System (UMLS) to find synonymous medical terms.
3. To evaluate the performance of the structured data extraction method and the NLP method when used for patient cohort identification.

### 28.1 Introduction

An active area of research in the biomedical informatics community involves developing techniques to identify patient cohorts for clinical trials and research studies that involve the secondary use of data from electronic health records (EHR) systems. The widening scale of EHR databases, that contain both structured and unstructured information, has been beneficial to clinical researchers in this regard. It has helped investigators identify individuals who may be eligible for

---

The two authors contributed equally to this work.

clinical trials as well as conduct retrospective studies to potentially validate the results of prospective clinical studies at a fraction of the cost and time [1]. It has also helped clinicians to identify patients at a higher risk of developing chronic disease, especially those who could benefit from early treatment [2].

Several studies have investigated the accuracy of structured administrative data such as the World Health Organization's (WHO) International Classification of Diseases, Ninth Revision (ICD-9) billing codes when identifying patient cohorts [3–11]. Extracting structured information using ICD-9 codes has been shown to have good recall, precision, and specificity [3, 4] when identifying distinct patient populations. However, for large clinical databases, information extraction can be time-consuming, costly, and impractical when conducted across several data sources [12] and applied to large cohorts [13].

Using structured queries to extract information from an EHR database allows one to retrieve data easily and in a more time-efficient manner. Structured EHR data is generally useful, but may also contain incomplete and/or inaccurate information especially when each data element is viewed in isolation. For example [14], to justify ordering a particular laboratory or radiology test, clinicians often assign a patient with a diagnosis code for a condition that the patient is suspected to have. But even when the test results point to the patient not having the suspected condition, the diagnosis code often remains in the patient's medical record. When the diagnosis code is then viewed without context (i.e., without the benefit of understanding the nuances of the case as provided in the patient's clinical narrative), this becomes problematic because it prohibits the ability of investigators to accurately identify patient cohorts and to utilize the full statistical potential of the available populations. Compared to narratives from clinical notes, relying solely on structured data such as diagnostic codes can be unreliable because they may not be able to provide information on the overall clinical context. However, automated examination of a large volume of clinical notes requires the use of natural language processing (NLP). The domain of study for the automated analysis of unstructured text data is referred to as NLP, and it has already been used with some success in the domain of medicine. In this chapter, we will be focusing on how NLP can be used to extract information from unstructured data for cohort identification.

NLP is a field of computer science and linguistics that aims to understand human (natural) languages and facilitate more effective interactions between humans and machines [13, 15]. In the clinical domain, NLP has been utilized to extract relevant information such as laboratory results, medications, and diagnoses from de-identified medical patient record narratives in order to identify patient cohorts that fit eligibility criteria for clinical research studies [16]. When compared to human chart review of medical records, NLP yields faster results [17–20]. NLP techniques have also been used to identify possible lung cancer patients based on their radiology reports [21] and extract disease characteristics for prostate cancer patients [22].

We considered chronic conditions where both a disease diagnosis and an intervention diagnosis were likely to be found together in an attempt to better highlight the differences between structured and unstructured retrieval techniques, especially given the limited number of studies that have looked at interventions or treatment procedures, rather than illness or disease, as outcomes [14]. The diabetic population was of particular interest for this NLP task because the numerous cardiovascular, ophthalmological, and renal complications associated with diabetes mellitus eventually require treatment interventions or procedures, such as hemodialysis in this case. Moreover, clinical notes frequently contain medical abbreviations and acronyms, and the use of NLP techniques can help in capturing and viewing these information correctly in medical records. Therefore, in this case study, we attempted to determine whether the use of NLP on the unstructured clinical notes of this population would help improve structured data extraction. We identified a cohort of critically ill diabetic patients suffering from end-stage renal failure who underwent hemodialysis using the Medical Information Mart for Intensive Care (MIMIC-III) database [23].

## 28.2 Methods

### 28.2.1 Study Dataset and Pre-processing

All data from this study were extracted from the publicly available MIMIC-III database. MIMIC-III contains de-identified [24] data, per Health Insurance Portability and Accountability Act (HIPAA) privacy rules [25], on over 58,000 hospital admissions in the intensive care units (ICU) at Beth Israel Deaconess Medical Center from June 2001 to October 2012 [26]. Aside from being publicly accessible, we chose MIMIC-III because it contains detailed EHR data on critically ill patients who are likely to have multiple chronic conditions, including those with complications from chronic diseases that would require life-saving treatment interventions.

We excluded all patients in the database who were under the age of 18; diagnosed with diabetes insipidus only and not diabetes mellitus; underwent peritoneal dialysis only and not hemodialysis; or those diagnosed with transient conditions such as gestational diabetes or steroid-induced diabetes without any medical history of diabetes mellitus. We also excluded patients who had received hemodialysis prior to their hospital admission but did not receive it during admission. From the remaining subjects, we included those who were diagnosed with diabetes mellitus and those who had undergone hemodialysis during their ICU admission. We extracted data from two primary sources: the structured MIMIC-III tables (discharge diagnoses and procedures) and unstructured clinical notes.

## 28.2.2 Structured Data Extraction from MIMIC-III Tables

Using the ICD-9 diagnosis codes from the discharge diagnoses table and ICD-9 procedure codes from the procedures table, we searched a publicly available ICD-9 [27] database to find illness diagnosis and procedure codes related to diabetes and hemodialysis as shown in Table 28.1. We used structured query language (SQL) to find patients in each of the structured data tables based on specific ICD-9 codes.

**Table 28.1** ICD-9 codes and descriptions indicating a patient was diagnosed with diabetes mellitus and who potentially underwent hemodialysis from structured data tables in MIMIC-III

Structured data table	ICD-9 code and description
<i>Diabetes mellitus</i>	
Discharge diagnosis codes	249 secondary diabetes mellitus (includes the following codes: 249, 249.0, 249.00, 249.01, 249.1, 249.10, 249.11, 249.2, 249.20, 249.21, 249.3, 249.30, 249.31, 249.4, 249.40, 249.41, 249.5, 249.50, 249.51, 249.6, 249.60, 249.61, 249.7, 249.70, 249.71, 249.8, 249.80, 249.81, 249.9, 249.90, 249.91)
	250 diabetes mellitus (includes the following codes: 250, 250.0, 250.00, 250.01, 250.02, 250.03, 250.1, 250.10, 250.11, 250.12, 250.13, 250.2, 250.20, 250.21, 250.22, 250.23, 250.3, 250.30, 250.31, 250.32, 250.33, 250.4, 250.40, 250.41, 250.42, 250.43, 250.5, 250.50, 250.51, 250.52, 250.53, 250.6, 250.60, 250.61, 250.62, 250.63, 250.7, 250.70, 250.71, 250.72, 250.73, 250.8, 250.80, 250.81, 250.82, 250.83, 250.9, 250.90, 250.91, 250.92, 250.93)
<i>Hemodialysis</i>	
Discharge diagnosis codes	585.6 end stage renal disease (requiring chronic dialysis)
	996.1 mechanical complication of other vascular device, implant, and graft
	996.73 other complications due to renal dialysis device, implant, and graft
	E879.1 kidney dialysis as the cause of abnormal reaction of patient, or of later complication, without mention of misadventure at time of procedure
	V45.1 postsurgical renal dialysis status
	V56.0 encounter for extracorporeal dialysis
Procedure codes	V56.1 fitting and adjustment of extracorporeal dialysis catheter
	38.95 venous catheterization for renal dialysis
	39.27 arteriovenostomy for renal dialysis
	39.42 revision of arteriovenous shunt for renal dialysis
	39.43 removal of arteriovenous shunt for renal dialysis
	39.95 hemodialysis



### 28.2.3 *Unstructured Data Extraction from Clinical Notes*

The unstructured clinical notes include discharge summaries (n = 52,746), nursing progress notes (n = 812,128), physician notes (n = 430,629), electrocardiogram (ECG) reports (n = 209,058), echocardiogram reports (n = 45,794), and radiology reports (n = 896,478). We excluded clinical notes that were related to any imaging results (ECG\_Report, Echo\_Report, and Radiology\_Report). We extracted notes from MIMIC-III with the following data elements: patient identification number (SUBJECT\_ID), hospital admission identification number (HADM\_IDs), intensive care unit stay identification number (ICUSTAY\_ID), note type, note date/time, and note text.

We used an SQL query to extract pertinent information from all patients' notes that will be helpful in identifying a patient as someone belonging to the cohort, then wrote a Python script to filter the notes by looking for keywords and implementing heuristics in order to refine our search results. As part of our search strategy, we removed the family history sections when searching the clinical notes and ensured that the search for clinical acronyms did not retrieve those that were part of another word. For example, our filters did not retrieve those where "DM" appeared as part of another words such as in 'admission' or 'admit'. Finally, we used cTAKES [28, 29] version 3.2 with access to Unified Medical Language System (UMLS) [30] concepts to use the negation detection annotator when searching the note text. The negation detection feature in cTAKES works by trying to detect which entities in the text are negated. Examples of negation words that may be found in the clinical notes include 'not', 'no', 'never', 'hold', 'refuse', 'declined'. For example, in this case study, if "DM" or "HD" is consistently negated when searching the clinical notes, then the patient should not be considered part of the cohort.

The Metathesaurus [31] in UMLS contains health and biomedical vocabularies, ontologies, and standard terminologies, including ICD. Each term is assigned to one or more concepts in UMLS. Different terms from different vocabularies or ontologies that have similar meanings and assigned with the same concept unique identifier (CU) are considered UMLS synonyms [32]. In order to identify diabetes mellitus patients who underwent hemodialysis during their ICU stay, we scanned the clinical notes containing the terms "diabetes mellitus" and "hemodialysis". We used the UMLS Metathesaurus to obtain synonyms for these terms because using only these two terms will restrict our search results.

cTAKES is an open-source natural language processing system that extracts information from clinical free-text stored in electronic medical records. It accepts either plain text or clinical document architecture (CDA)-compliant extensible markup language (XML) documents and consists of several annotators such as attributes extractor (assertion annotator), clinical document pipeline, chunker, constituency parser, context dependent tokenizer, dependency parser and semantic role labeler, negation detection, document preprocessor, relation extractor, and dictionary lookup, among others [33]. When performing named entity recognition

or concept identification, each named entity is mapped to a specific terminology concept through the cTAKES dictionary lookup component [28], which uses the UMLS as a dictionary.

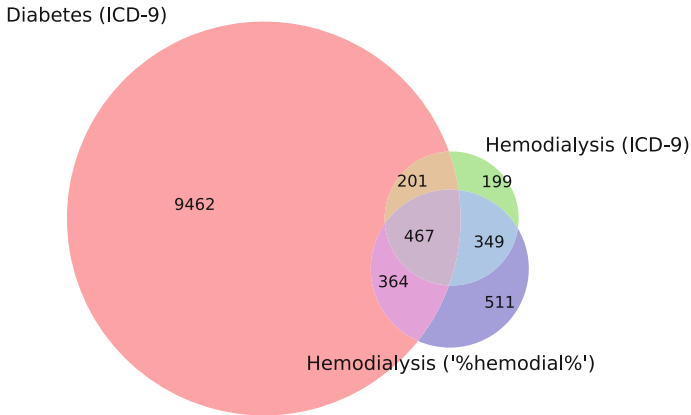
We refined our query parameters iteratively and searched the clinical notes containing our final query parameters based on UMLS synonyms to diabetes and hemodialysis. These were as follows: (A) include documents that contained any of the following terms: diabetes, diabetes mellitus, DM; (B) include documents that contained any of the following terms: hemodialysis, haemodialysis, kidney dialysis, renal dialysis, extracorporeal dialysis, on HD, HD today, tunneled HD, continue HD, cont HD; (C) finalize the set of documents to be run in cTAKES by only including documents that contained at least one of the terms from group A and at least one of the terms from group B; and (D) exclude documents by using the negation detection annotator in cTAKES to detect negations such as avoid, refuse, never, declined, etc. that appear near any of the terms listed in groups A and B.

### 28.2.4 Analysis

We manually reviewed all the notes for all patients identified by the structured data extraction method and/or the clinical NLP method as those potentially to have a diagnosis of diabetes mellitus and who had undergone hemodialysis during their ICU stay in order to create a validation database that contains the positively identified patients in the population of MIMIC-III patients. We used this validation database in evaluating the precision and recall of both the structured data extraction method and the clinical NLP method. We compared the results from both methods to the validation database in order to determine the true positives, false positives, recall, and precision. We defined these parameters using the following equation:  $\text{recall} = \text{TP}/(\text{TP} + \text{FN})$ , where TP = true positives and FN = false negatives; and  $\text{precision} = \text{TP}/(\text{TP} + \text{FP})$ , where FP = false positives. In this case study, we defined recall as the proportion of diabetic patients who have undergone hemodialysis in the validation database who were identified as such. We defined precision as the proportion of patients identified as diabetic and having undergone hemodialysis whose diagnoses were both confirmed by the validation database.

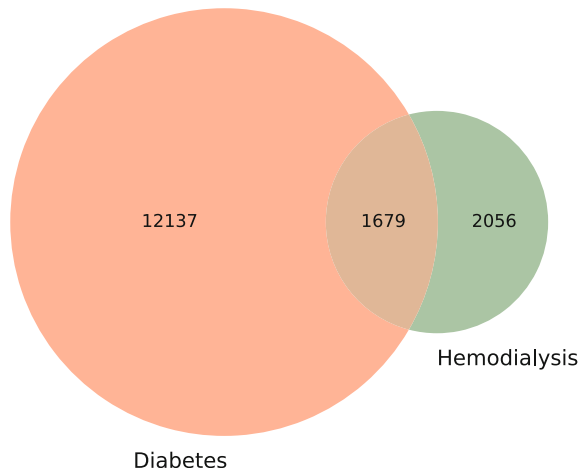
## 28.3 Results

In the structured data extraction method using SQL as illustrated in Fig. 28.1, we found 10,494 patients diagnosed with diabetes mellitus using ICD-9 codes; 1216 patients who underwent hemodialysis using ICD-9 diagnosis and procedure codes; and 1691 patients who underwent hemodialysis when searching the structured data tables using the string ‘%hemodial%’. Figure 28.2 shows the number of patients



**Fig. 28.1** Patients identified by structured data extraction, clockwise from *left* diagnosed with diabetes mellitus using ICD-9 diagnosis codes, underwent hemodialysis using ICD-9 discharge diagnosis and procedure codes, and underwent hemodialysis using the string '%hemodial%'

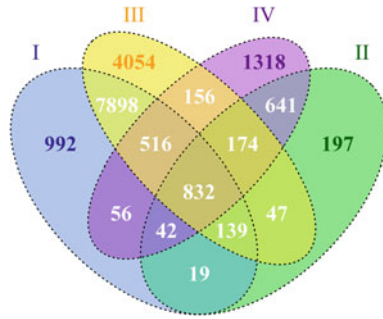
**Fig. 28.2** Patients identified by clinical NLP method, from *left* diagnosed with diabetes, diagnosed with diabetes and who underwent hemodialysis, and who underwent hemodialysis



identified using the clinical NLP method: 13,816 patients diagnosed with diabetes mellitus and 3735 patients identified as having undergone hemodialysis during their ICU stay.

There were 1879 patients in the validation database consisting of 1847 (98.3 %) confirmed diabetic patients who had undergone hemodialysis. We identified 1032 (54.9 % of 1879) patients when using SQL only and 1679 (89.4 % of 1879) when using cTAKES. Of these, 832 (44.3 % of 1879) were found by both approaches as illustrated in Fig. 28.3.

Table 28.2 shows the results of the two methods used to identify patient cohorts compared to the validation database. The clinical NLP method had better precision compared to the structured data extraction method. The clinical NLP method also



**Fig. 28.3** Patients identified by structured data extraction and clinical NLP methods: *I*—diabetes patients found using SQL; *II*—patients who underwent hemodialysis found using SQL; *III*—diabetic patients found using cTAKES and; *IV*—patients who underwent hemodialysis found using cTAKES

**Table 28.2** Precision of identifying patient cohorts using structured data extraction and clinical NLP compared to the validation database

Validation database (n = 1879)	Structured data extraction method, positive (n = 1032)	Clinical NLP method, positive (n = 1679)
Positive	TP = 1013	TP = 1666
Negative	FP = 19	FP = 13
Precision	98.2 %	99.2 %

identified fewer FP (0.8 % of 1679) compared to the structured data extraction method (1.8 % of 1032).

In this case study, the recall value could not be computed. But because recall is calculated by dividing TP by the sum of TP and FN, and the denominator for both methods is the same, we can use the TP count as a proxy to determine which method showed a higher recall. Based on the results, we found that more TPs were identified using NLP compared to the structured data approach. Hence, the clinical NLP method yielded a higher recall than the structured data extraction method.

We also analyzed the clinical notes for the 19 patients identified as FP using the structured data extraction method. We found that 14 patients were incorrectly identified as diabetic patients, 3 patients were incorrectly identified as having undergone hemodialysis, and 2 patients were not diabetic nor did they undergo hemodialysis during their ICU stay. In the 13 patients identified as FP when using the clinical NLP method, we also analyzed the clinical notes and found that 5 did not undergo hemodialysis during their ICU stay, 2 had initially undergone hemodialysis but was stopped due to complications, and 6 did not have diabetes (3 did not have any history of diabetes, 1 had initially been presumed to have diabetes according to the patient’s family but was not the case, 1 had gestational diabetes without prior history of diabetes mellitus, and 1 was given insulin several times during the patient’s ICU stay but was not previously diagnosed with diabetes nor was a diagnosis of new-onset diabetes indicated in any of the notes).

## 28.4 Discussion

Both the structured data extraction method and the clinical NLP method achieved high precision in identifying diabetic patients who underwent hemodialysis during their ICU stay. However, the clinical NLP method exhibited better precision and higher recall in a more time-saving and efficient way compared to the structured data extraction technique.

We identified several variables that may have resulted in a lower precision when using SQL only in identifying patient cohorts such as the kind of illness and the kind of intervention, the presence of other conditions similar to diabetes (i.e., diabetes insipidus, gestational diabetes), and the presence of other interventions similar to hemodialysis (i.e., peritoneal dialysis, continuous renal replacement therapy). The temporal feature of the intervention also added to the complexity of the cohort identification process.

Extracting and using the UMLS synonyms for “diabetes mellitus” and “hemodialysis” in performing NLP on the clinical notes helped increase the number of patients included in the final cohort. Knowing that clinicians often use acronyms, such as “DM” to refer to diabetes mellitus and “HD” for hemodialysis, and abbreviations, such as “cont” for the word ‘continue’ when taking down notes helped us refine our final query parameters.

There are several limitations to this case study. Specificity could not be calculated because in order to determine the TN and FN, the entire MIMIC-III database would need to be manually validated. Though it can be argued that the ones in the validation database that were missed by either method could be considered as FN, this may not be the true FN count in MIMIC-III because those that could be found outside of the validation database have not been included. Moreover, since the validation database used was not independent of the two methods, the TP and FP counts as well as the precision and recall may have been overestimated.

Another limitation is the lack of a gold standard database for the specific patient cohort we investigated. Without it, we were not able to fully evaluate the cohort identification methods we implemented. The creation of a gold standard database, one that is validated by clinicians and includes patients in the MIMIC-III database that have been correctly identified as TN and FN, for this particular patient cohort will help to better evaluate the performance of the methods used in this case study. Having a gold standard database will also help calculate the specificity for both methods.

Another limitation is that we focused on discharge diagnosis and procedure events especially in the structured data extraction method. Other data sources in MIMIC-III such as laboratory results and medications may help support the findings or even increase the number of patients identified when using SQL.

Furthermore, although we used a large database, our data originated from a single data source. Comparing our results found using MIMIC-III to other publicly available databases containing EHR data may help to assess the generalizability of our results.

## 28.5 Conclusions

NLP is an efficient method for identifying patient cohorts in large clinical databases and produces better results when compared to structured data extraction. Combining the use of UMLS synonyms and a negation detection annotator in a clinical NLP tool can help clinical researchers to better perform cohort identification tasks using data from multiple sources within a large clinical database.

### Future Work

Investigating how clinical researchers could take advantage of NLP when mining clinical notes would be beneficial for the scientific research community. In this case study, we found that using NLP yields better results for patient cohort identification tasks compared to structured data extraction.

Using NLP may potentially be useful for other time-consuming clinical research tasks involving EHR data collected in the outpatient departments, inpatient wards, emergency departments, laboratories, and various sources of medical data. The automatic detection of abnormal findings mentioned in the results of diagnostic tests such as X-rays or electrocardiograms could be systematically used to enhance the quality of large clinical databases. Time-series analyses could also be improved if NLP is used to extract more information from the free-text clinical notes.

### Notes

1. cTAKES is available from the cTAKES Apache website: <http://ctakes.apache.org/downloads.cgi>. A description of the components of cTAKES 3.2 can be found on the cTAKES wiki page: <https://cwiki.apache.org/confluence/display/CTAKES/CTAKES+3.2+Component+Use+Guide> [28].

**Open Access** This chapter is distributed under the terms of the Creative Commons Attribution-NonCommercial 4.0 International License (<http://creativecommons.org/licenses/by-nc/4.0/>), which permits any noncommercial use, duplication, adaptation, distribution and reproduction in any medium or format, as long as you give appropriate credit to the original author(s) and the source, a link is provided to the Creative Commons license and any changes made are indicated.

The images or other third party material in this chapter are included in the work's Creative Commons license, unless indicated otherwise in the credit line; if such material is not included in the work's Creative Commons license and the respective action is not permitted by statutory regulation, users will need to obtain permission from the license holder to duplicate, adapt or reproduce the material.

## Code Appendix

All the SQL queries to count the number of patients per cohorts as well as the cTAKES XML configuration file used to analyze the notes are available from the GitHub repository accompanying this book: <https://github.com/MIT-LCP/critical->

[data-book](#). Further information on the code is available from this website. The following key scripts were used:

- *cohort\_diabetic\_hemodialysis\_icd9\_based\_count.sql*: Total number of diabetic patients who underwent hemodialysis based on diagnosis codes.
- *cohort\_diabetic\_hemodialysis\_notes\_based\_count.sql*: List of diabetic patients who underwent hemodialysis based on unstructured clinical notes.
- *cohort\_diabetic\_hemodialysis\_proc\_and\_notes\_based\_count.sql*: Total number of diabetic patients who underwent hemodialysis based on unstructured clinical notes and procedure codes.
- *cohort\_diabetic\_hemodialysis\_proc\_based\_count.sql*: Total number of diabetic patients who underwent hemodialysis based on procedure codes.
- *cohort\_diabetic\_icd9\_based\_count\_a.sql*: List of diabetic patients based on the ICD-9 codes.
- *cohort\_hemodialysis\_icd9\_based\_count\_b.sql*: List of patients who underwent hemodialysis based on the ICD-9 codes.
- *cohort\_hemodialysis\_proc\_based\_count\_c.sql*: Lists number of patients who underwent hemodialysis based on the procedure label.
- *CPE\_physician\_notes.xml*: cTAKES XML configuration file to process patients' notes. Some paths need to be adapted to the developer's configuration.

## References

1. Kury FSP, Huser V, Cimino JJ (2015) Reproducing a prospective clinical study as a computational retrospective study in MIMIC-II. In: AMIA Annual Symposium Proceedings, pp 804–813
2. Bates DW, Saria S, Ohno-Machado L, Shah A, Escobar G (2014) Big data in health care: using analytics to identify and manage high-risk and high-cost patients. *Health Aff (Millwood)* 33(7):1123–1131
3. Segal JB, Powe NR (2004) Accuracy of identification of patients with immune thrombocytopenic purpura through administrative records: a data validation study. *Am J Hematol* 75(1):12–17
4. Eichler AF, Lamont EB (2009) Utility of administrative claims data for the study of brain metastases: a validation study. *J Neuro-Oncol* 95(3):427–431
5. Kern EF, Maney M, Miller DR, Tseng CL, Tiwari A, Rajan M, Aron D, Pogach L (2006) Failure of ICD-9-CM codes to identify patients with comorbid chronic kidney disease in diabetes. *Health Serv Res* 41(2):564–580
6. Zhan C, Eixhauser A, Richards CL Jr, Wang Y, Baine WB, Pineau M, Verzier N, Kilman R, Hunt D (2009) Identification of hospital-acquired catheter-associated urinary tract infections from Medicare claims: sensitivity and positive predictive value. *Med Care* 47(3):364–369
7. Floyd JS, Heckbert SR, Weiss NS, Carell DS, Psaty BM (2012) Use of administrative data to estimate the incidence of statin-related rhabdomyolysis. *J Am Med Assoc* 307(15):1580–1582

8. van Walraven C, Austin PC, Manuel D, Knoll G, Jennings A, Forster AJ (2010) The usefulness of administrative databases for identifying disease cohorts is increased with a multivariate model. *J Clin Epidemiol* 63(12):1332–1341
9. Tieder JS, Hall M, Auger KA, Hain PD, Jerardi KE, Myers AL, Rahman SS, Williams DJ, Shah SS (2011) Accuracy of administrative billing codes to detect urinary tract infection hospitalizations. *Pediatrics* 128:323–330
10. Rosen LM, Liu T, Merchant RC (2012) Efficiency of International Classification of Diseases, Ninth Revision, billing code searches to identify emergency department visits for blood and body fluid exposures through a statewide multicenter database. *Infect Control Hosp Epidemiol* 33:581–588
11. Lamont EB, Lan L (2014) Sensitivity of Medicare claims data for measuring use of standard multiagent chemotherapy regimens. *Med Care* 52(3):e15–e20
12. Bache R, Miles S, Taweel A (2013) An adaptable architecture for patient cohort identification from diverse data sources. *J Am Med Inform Assoc* 20(e2):e327–e333
13. Sada Y, Hou J, Richardson P, El-Serag H, Davila J (2013) Validation of case finding algorithms for hepatocellular cancer from administrative data and electronic health records using natural language processing. *Med Care*
14. Abhyankar S, Demner-Fushman D, Callaghan FM, McDonald CJ (2014) Combining structured and unstructured data to identify a cohort of ICU patients who received dialysis. *J Am Med Inform Assoc* 21(5):801–807
15. Jurafsky D, Martin H (2008) *Speech and language processing*, 2nd edn. Prentice Hall, Englewood Cliffs, NJ
16. Voorhees EM, Tong RM (2011) Overview of the TREC 2011 medical records track. In: *The twentieth text retrieval conference proceedings (TREC 2011)*. National Institute for Standards and Technology, Gaithersburg, MD
17. Wilbur WJ, Rzhetsky A, Shatkay H (2006) New directions in biomedical text annotation: definitions, guidelines and corpus construction. *BMC Bioinform* 7:356
18. Buchan NS, Rajpal DK, Webster Y, Alatorre C, Gudivada RC, Zheng C, Sanseau P, Koehler J (2011) The role of translational bioinformatics in drug discovery. *Drug Discov Today* 16:426–434
19. Nadkarni PM, Ohno-Machado L, Chapman WW (2011) Natural language processing: an introduction. *J Am Med Inform Assoc* 18:544–551
20. Uzuner Ö, South BR, Shen S, Duvall SL (2011) 2010 i2b2/VA challenge on concepts, assertions, and relations in clinical text. *J Am Med Inform Assoc* 18(5):552–556
21. Danforth KN, Early MI, Ngan S, Kosco AE, Zheng C, Gould MK (2012) Automated identification of patients with pulmonary nodules in an integrated health system using administrative health plan data, radiology reports, and natural language processing. *J Thorac Oncol* 7:1257–1262
22. Thomas AA, Zheng C, Jung H, Chang A, Kim B, Gelfond J, Slezak J, Porter K, Jacobsen SJ, Chien GW (2014) Extracting data from electronic medical records: validation of a natural language processing program to assess prostate biopsy results. *World J Urol* 32(1):99–103
23. Saeed M, Villarroel M, Reisner AT, Clifford G, Lehman LW, Moody G, Heldt T, Kyaw TH, Moody B, Mark RG (2011) Multiparameter intelligent monitoring in intensive care II: a public-access intensive care unit database. *Crit Care Med* 39(5):952–960
24. Neamatullah I, Douglass MM, Lehman LW, Reisner A, Villarroel M, Long WJ, Szolovits P, Moody GB, Mark RG, Clifford GD (2008) Automated de-identification of free-text medical records. *BMC Med Inform Decis Mak* 8:32
25. Standards for Privacy of Individually Identifiable Health Information; Final Rule, 45 CFR Parts 160 and 164 (2002) <http://www.hhs.gov/ocr/privacy/hipaa/administrative/privacyrule/privrule.txt>. Last accessed 6 Oct 2015
26. MIMIC. <https://mimic.physionet.org/gettingstarted/access>. Last accessed 19 Feb 2016
27. The Web’s Free 2015 Medical Coding Reference. <http://www.icd9data.com>. Last accessed 7 Oct 2015



28. Savova GK, Masanz JJ, Ogren PV, Zheng J, Sohn S, Kipper-Schuler KC, Chute CG (2010) Mayo clinical Text Analysis and Knowledge Extraction System (cTAKES): architecture, component evaluation and applications. *J Am Med Inform Assoc* 17(5):507–513
29. Apache cTAKES™. <http://cTAKES.apache.org/index.html>. Last accessed 3 Oct 2015
30. Lindberg DA, Humphreys BL, McCray AT (1993) The unified medical language system. *Meth Inf Med* 32(4):281–291
31. Unified Medical Language System® (UMLS®) The Metathesaurus. [https://www.nlm.nih.gov/research/umls/new\\_users/online\\_learning/Meta\\_001.html](https://www.nlm.nih.gov/research/umls/new_users/online_learning/Meta_001.html). Last accessed 7 Oct 2015
32. Griffon N, Chebil W, Rollin L, Kerdelhue G, Thirion B, Gehanno JF, Darmoni SJ (2012) Performance evaluation of unified medical language system®'s synonyms expansion to query PubMed. *BMC Med Inform Decis Mak* 12:12
33. cTAKES 3.2 Component Use Guide. <https://cwiki.apache.org/confluence/display/CTAKES/cTAKES+3.2+Component+Use+Guide>. Last accessed 7 Oct 2015

# Chapter 29

## Hyperparameter Selection

Franck Dernoncourt, Shamim Nemati, Elias Baedorf Kassis  
and Mohammad Mahdi Ghassemi

### Learning Objectives

High Level:

Learn how to choose optimal hyperparameters in a machine learning pipeline for medical prediction.

Low Level:

1. Learn the intuition behind Bayesian optimization.
2. Understand the genetic algorithm and the multistart scatter search algorithm.
3. Learn the multiscale entropy feature.

### 29.1 Introduction

Using algorithms and features to analyze medical data to predict a condition or an outcome commonly involves choosing hyperparameters. A hyperparameter can be loosely defined as a parameter that is not tuned during the learning phase that optimizes the main objective function on the training set. While a simple grid search would yield the optimal hyperparameters by trying all possible combinations of hyper parameters, it does not scale as the number of hyperparameters and the data set size increase. As a result, investigators typically choose hyperparameters arbitrarily, after a series of manual trials, which can sometimes cast doubts on the results as investigators might have been tempted to tune the parameters specifically for the test set. In this chapter, we present three mathematically grounded techniques to automatically optimize hyperparameters: Bayesian optimization, genetic algorithms, and multistart scatter search.

To demonstrate the use of these hyperparameter selection methods, we focus on the prediction of hospital mortality for patients in the ICU with severe sepsis. The

---

The original version of this chapter was revised: A chapter author's name Shamim Nemati was added. The erratum to this chapter is available at [10.1007/978-3-319-43742-2\\_30](https://doi.org/10.1007/978-3-319-43742-2_30)

outcome we consider is binary: either the patient died in hospital, or survived. Sepsis patients are at high risk for mortality (roughly 30 % [1]), and the ability to predict outcomes is of great clinical interest. The APACHE score [2] is often used for mortality prediction, but has significant limitations in terms of clinical use as it often fails to accurately predict individual patient outcomes, and does not take into account dynamic physiological measurements. To remediate this issue, we investigate the use of multiscale entropy (MSE) [3, 4] applied to heart rate (HR) signals as an outcome predictor: MSE measures the complexity of finite length time series. To compute MSE, one needs to specify a set of parameters, namely the maximum scale factor, the difference between consecutive scale factors, the length of sequences to be compared and a similarity threshold. We show that using hyperparameter selection methods, the MSE can predict the patient outcome more accurately than the APACHE score.

## 29.2 Study Dataset

We used the Medical Information Mart for Intensive Care II (MIMIC II) database, which is available online for free and was introduced by [5, 6]. MIMIC II is divided into two different data sets:

- the Clinical Database, which is a relational database that contains structured information such as patient demographics, hospital admissions and discharge dates, room tracking, death dates, medications, lab tests, and notes by the medical personnel.
- the Waveform Database, which is a set of flat files containing up to 22 different kinds of signals for each patient, including the ECG signals.

We selected patients who suffered from severe sepsis, defined as patients with an identified infection with evidence of organ dysfunction and hypotension requiring vasopressors and/or fluid resuscitation [7]. We further refined the patient cohort by choosing patients who had complete ECG waveforms for their first 24 h in the ICU. For each patient, we extracted the binary outcome (i.e. whether they died in hospital) from the clinical database. The HR signals were extracted from the ECG signals, and patients with low quality HR were removed.

## 29.3 Study Methods

We compared the predictive power of the following three sets of features to predict patient outcomes: basic descriptive statistics on the time series (mean and standard deviation), APACHE IV score and MSE. Since these features are computed on time series, for each feature set we obtained a vector of time series features. Once these features were computed, we clustered patients based on these vectors using spectral clustering. The number of clusters was determined using the silhouette values [8]. This allowed us to address the high heterogeneity of the data resulting from the fact

that MIMIC patients came from different care units. Lastly, for each cluster, we trained a support vector machine (SVM) classifier. To classify a new patient, we computed the distance from each cluster center, and computed the output of each SVM classifier: to make the final decision on the predicted outcome, we computed a weighted average of the output of each SVM classifier, where the weights were the distance from each cluster center. This method of combining clustering with SVM is called transductive SVM. We used the area under the receiver operating characteristic (ROC) curve (AUROC, often named more simply and ambiguously AUC) as the performance metric for the classification. Figure 29.1 illustrates the functioning of transductive SVMs.

MSE may be understood as the set of sample entropy values for a signal which is averaged over various increasing segment lengths. The MSE,  $y$ , was computed as follows:

$$y_j^\tau = \frac{1}{\tau} \sum_{i=(j-1)\tau+1}^{j\tau} x_i$$

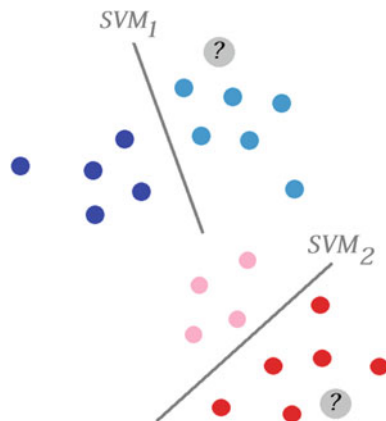
where:

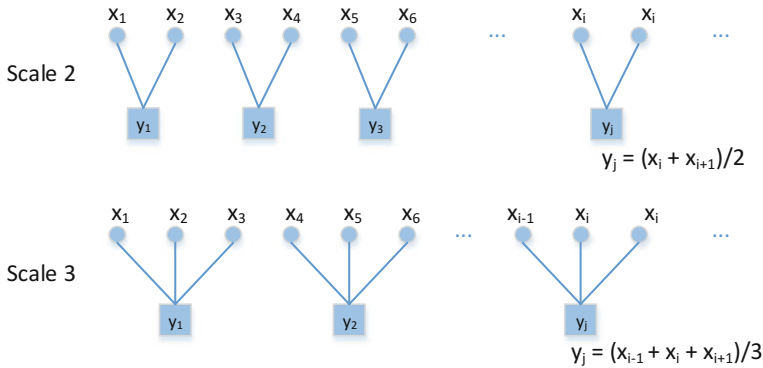
- $x_i$  is the signal value at sample  $i$ ,
- $j$  is the index of the window to be computed,
- $\tau$  is the scale factor,
- $Y$  is the length of sequences to be compared,
- $Z$  is the similarity threshold.

Additionally, we have the following parameters:

- the maximum scale factor,
- the scale increase, which is the difference between consecutive scale factors,
- the similarity criterion or threshold, denoted  $r$ .

**Fig. 29.1** Transductive SVM: clustering is performed first, then a convex combination of the SVM outputs is used to obtain the final prediction probability





**Fig. 29.2** Illustration of various scales from Costa et al. Only scales 2 and 3 are displayed.  $x_i$  is the signal value at sample  $i$

Figure 29.2 shows how  $y$  is computed for different scales.

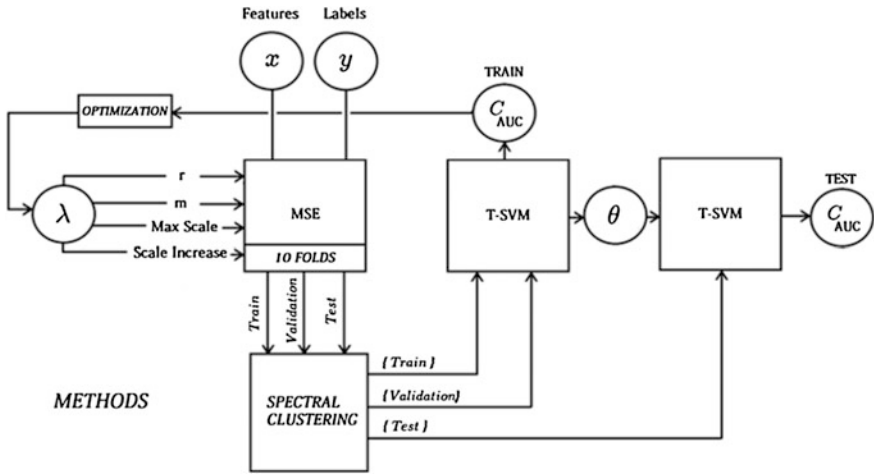
To select the best hyperparameters for the MSE, we compared three hyperparameter optimization techniques: Bayesian optimization, genetic algorithms, and multistart scatter search.

Bayesian optimization builds the distribution  $P(y_{\text{test}}|y_{\text{train}}, x_{\text{train}}, x_{\text{test}})$ , where  $x_{\text{train}}$  is the set of MSE parameters that were used to obtain the  $y_{\text{train}}$  AUROCs,  $x_{\text{test}}$  is a new set of MSE parameters, and  $y_{\text{test}}$  is the AUROC that would be obtained using the new MSE parameters. To put it otherwise, based on the previous observations on MSE parameters and achieved AUROCs, the Bayesian optimization predicts what AUROC a new set of MSE parameters will yield. Each time a new AUROC is computed, the set of MSE parameters as well as the AUROC is added to  $x_{\text{test}}$  and  $y_{\text{test}}$ . At each iteration, we can either explore, i.e. compute  $y_{\text{test}}$  for which the distribution  $P$  has a high variance, or exploit, i.e. compute  $y_{\text{test}}$  for which the distribution  $P$  has a low variance and high expectation. An implementation can be found in [9].

A genetic algorithm is an optimization algorithm based on the principle of Darwinian natural selection. A population is comprised of sets of MSE parameters. Each set of MSE parameters is evaluated based on the AUROC it achieved. The sets of MSE parameters with low AUROCs are eliminated. The surviving sets of MSE parameters are mutated, i.e. each parameter is slightly modified, to create new sets of MSE parameters, which form a new population. By iterating through this process, the new sets of MSE parameters yield increasingly high AUROCs. We set the population size of 100, and ran the optimization for 30 min. The first population was drawn randomly.

The multistart scatter search is similar to the genetic algorithm, the only difference residing in the use of a deterministic process to identify the individuals of the next population such as gradient descent.

Figure 29.3 summarizes the machine learning pipeline presented in this section.



**Fig. 29.3** The entire machine learning pipeline. The MSE features are computed from the input  $x$  using the parameters  $r$ ,  $m$ , max scale and scale increase. 10 folds are created

The data set was split into testing (20 %), validation (20 %) and training (60 %) sets. In order to ensure robustness of the result, we used 10-fold cross-validation, and the average AUROC over the 10 folds. To make the comparison fair, each hyperparameter optimization technique was run the same amount of time, viz. 30 min.

### 29.4 Study Analysis

Table 29.1 contains the results for all three sets of features we considered. For the MSE features, Table 29.1 presents the results achieved by keeping the default hyperparameters, or by optimizing them using one of the three hyperparameter optimization techniques we presented in the previous section.

The first set of features, namely the basic descriptive statistics (mean and standard deviation), yields an AUROC of 0.54 on the testing set, which is very low since a random classifier yields an AUROC of 0.50. The second set of features, APACHE IV, achieves a much higher AUROC, 0.68, which is not surprising as the APACHE IV was designed to be a hospital mortality assessment for critically ill patients. The third set of features based on MSE performs surprisingly well with the default values (AUROC of 0.66), and even better when optimized with any of the three hyperparameter optimization techniques. The Bayesian optimization yields the highest AUROC, 0.72.

**Table 29.1** Comparison of APACHE feature, time-series mean and standard deviation features, and MSE feature with default parameters or optimized with Bayesian optimization, genetic algorithms, and multistart scatter search, for the prediction of patient outcome

	Max scale	Scale increase	$r$	$m$	AUROC (training)	AUROC (testing)
Time series: mean and standard deviation					0.56 (0.52–0.56)	0.54 (0.45–0.60)
APACHE IV					0.77 (0.75–0.79)	0.68 (0.55–0.77)
MSE (defaults)	20	1	0.15	2	0.77 (0.73–0.78)	0.66 (0.60–0.72)
MSE (Bayesian)	17.62 (8.68)	2.59 (0.93)	0.11 (0.07)	2.58 (0.85)	0.77 (0.69–0.79)	0.72 (0.63–0.78)
MSE (genetic)	23.54 (14.34)	2.56 (1.12)	0.18 (0.15)	2.07 (0.70)	0.77 (0.67–0.84)	0.67 (0.44–0.78)
MSE (multi-start)	19.03 (12.57)	2.35 (0.87)	0.18 (0.128)	2.53 (0.87)	0.73 (0.69–0.76)	0.69 (0.53–0.72)

For each MSE parameter we report their cross-fold mean and standard deviation (with standard deviation in parenthesis). For the reported AUROC, we report the 50th percentile in the top half of the cell and the 25th and 75th percentiles in the lower half of the cell

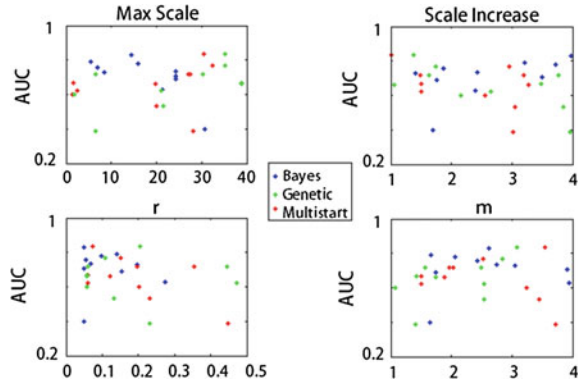
## 29.5 Study Visualizations

Figure 29.4 provides an insight into the MSE parameters selected by the three hyperparameter selection techniques over the 10-fold cross-validation. Each point represents a parameter value optimized by a given hyperparameter selection technique for a unique data fold. For all 4 MSE parameters, we observe a great variance: this indicates that there is no clear global optimum, but instead there exist many MSE parameter sets that yield a high AUROC.

Interestingly, in this experiment the Bayesian optimization is more robust to the parameter variance, as shown by the confidence intervals around the AUROCs: most AUROCs reached by Bayesian optimization are high, unlike genetic algorithms and multistart scatter search. The two latter techniques are susceptible to premature convergence, while Bayesian optimization has a better exploration-exploitation tradeoff.

We also notice that the max scale and the  $r$  values reached by Bayesian optimization have a lower variance than genetic algorithms and multistart scatter search. One might hypothesize that heterogeneity across patients might be reflected more in the scale increase and  $m$  MSE parameters than in the max scale and  $r$  parameters.

**Fig. 29.4** The impact of the MSE parameters on the outcome prediction AUROC



## 29.6 Study Conclusions

The results of this case study demonstrate two main points. First, from a medical standpoint, they underline the possible benefit of utilizing dynamic physiologic measurements in outcome prediction for ICU patients with severe sepsis: the data from this study indeed suggest that utilizing these physiological dynamics through MSE with optimized hyperparameters yields improved mortality prediction compared with the APACHE IV score. Physiological signals sampled at high-frequency are required for the MSE features to be meaningful, highlighting the need for high-resolution data collection, as opposed to some existing methods of data collection where signal samples are aggregated at the second or minute level, if not more, before being recorded.

Second, from a methodological standpoint, the results make a strong case for the use of hyperparameter selection techniques. Unsurprisingly, the results obtained with the MSE features are highly dependent on the MSE hyperparameters. Had we not used a hyperparameter selection technique and instead kept the default value, we would have concluded that APACHE IV provides a better predictive insight than MSE, and therefore missed the importance of physiological dynamics for prediction of patient outcome. Bayesian optimization seems to yield better results than genetic algorithms and multistart scatter search.

## 29.7 Discussion

There is still much room for further investigation. We focused on ICU patients with severe sepsis, but many other critically ill patient cohorts would be worth investigating as well. Although we restricted our study to the use of MSE and HR alone, it would be interesting to integrate and combine other disease characteristics and physiological signals. For example, [10] used Bayesian optimization to find the



most optimal wavelet parameters to predict acute hypotensive episodes. Perhaps combining dynamic blood pressure wavelets with HR MSE, and even other dynamic data as well such as pulse pressure variation, would further optimize and tune the mortality prediction model. In addition there exist other scores to predict group mortality such as SOFA and SAPS II, which would provide useful baselines in addition to APACHE [11].

The scale of our experiments was satisfying for the case study's goals, but some other investigations might require a data set that is an order of magnitude larger. This might lead one to adopt a distributed design to deploy the hyperparameter selection techniques. For example, [12] used a distributed approach to hyperparameter optimization on 5000 patients and over one billion blood pressure beats. [13, 14] present another large-scale system to use genetic algorithms for blood pressure prediction.

Lastly, a more thorough comparison between hyperparameter selection techniques would help comprehend why a given hyperparameter selection technique performs better than others for a particular prediction problem. Especially, the hyperparameter selection techniques also have parameters, and a better understanding of the impact of these parameters on the results warrant further investigation.

## 29.8 Conclusions

In this chapter, we have presented three principled hyperparameter selection methods. We applied them to MSE, which we computed on physiological signals to illustrate their use. More generally, these methods can be used for any algorithm and feature where hyperparameters need to be tuned.

ICU data provide a unique opportunity for this type of research with routinely collected continuously measured variables including ECG waveforms, blood pressure waveforms from arterial lines, pulse pressure variation, pulse oximetry as well as extensive ventilator data. These dynamic physiologic measurements could potentially help unlock better outcome metrics and improve management decisions in patients with acute respiratory distress syndrome (ARDS), septic shock, liver failure or cardiac arrest, and other extremely ill ICU patients. Outside of the ICU, dynamic physiological data is routinely collected during surgery by the anesthesia team, in cardiac units with continuous telemetry and on Neurological care units with routine EEG measurements for patients with or at risk for seizures. As such the potential applications of MSE with hyperparameter optimization are extensive.

**Open Access** This chapter is distributed under the terms of the Creative Commons Attribution-NonCommercial 4.0 International License (<http://creativecommons.org/licenses/by-nc/4.0/>), which permits any noncommercial use, duplication, adaptation, distribution and reproduction in any medium or format, as long as you give appropriate credit to the original author(s) and the source, a link is provided to the Creative Commons license and any changes made are indicated.

The images or other third party material in this chapter are included in the work's Creative Commons license, unless indicated otherwise in the credit line; if such material is not included in the work's Creative Commons license and the respective action is not permitted by statutory regulation, users will need to obtain permission from the license holder to duplicate, adapt or reproduce the material.

## References

1. Angus DC, Linde-Zwirble WT, Lidicker J, Clermont G, Carcillo J, Pinsky MR (2001) Epidemiology of severe sepsis in the United States: analysis of incidence, outcome, and associated costs of care. *Crit Care Med* 29(7):1303–1310
2. Saeed M, Villarroel M, Reisner AT, Clifford G, Lehman L, Moody GB, Heldt T, Kyaw TH, Moody BE, Mark RG (2011) Multiparameter intelligent monitoring in intensive care II (MIMIC-II): a public-access ICU database. *Crit Care Med* 39(5):952–960. doi:10.1097/CCM.0b013e31820a92c6
3. Goldberger AL, Amaral LAN, Glass L, Hausdorff JM, Ivanov PCh, Mark RG, Mietus JE, Moody GB, Peng C-K, Stanley HE (2000) PhysioBank, PhysioToolkit, and PhysioNet: components of a new research resource for complex physiologic signals. *Circulation* 101(23): e215–e220 [Circulation Electronic Pages; <http://circ.ahajournals.org/cgi/content/full/101/23/e215>]
4. Mayaud L, Lai PS, Clifford GD, Tarassenko L, Celi LA, Annane D (2013) Dynamic data during hypotensive episode improves mortality predictions among patients with sepsis and hypotension\*. *Crit Care Med* 41(4):954–962
5. Ng AY, Jordan MI, Weiss Y et al (2002) On spectral clustering: analysis and an algorithm. *Adv Neural Inf Process Syst* 2:849–856
6. Snoek J, Larochelle H, Adams RP (2012) Practical Bayesian optimization of machine learning algorithms. *Adv Neural Inf Process Syst* 29:2951–2959
7. Deroncourt F, Veeramachaneni K, O'Reilly U-M (2015) Gaussian process-based feature selection for wavelet parameters: predicting acute hypotensive episodes from physiological signals. In: Proceedings of the 2015 IEEE 28th international symposium on computer-based medical systems. IEEE Computer Society
8. Castella X et al (1995) A comparison of severity of illness scoring systems for intensive care unit patients: results of a multicenter, multinational study. *Crit Care Med* 23(8):1327–1335
9. Deroncourt F, Veeramachaneni K, O'Reilly U-M (2013c) BeatDB: a large-scale waveform feature repository. In: NIPS 2013, machine learning for clinical data analysis and healthcare workshop
10. Hemberg E, Veeramachaneni K, Deroncourt F, Wagdy M, O'Reilly U-M (2013) Efficient training set use for blood pressure prediction in a large scale learning classifier system. In: Proceeding of the fifteenth annual conference companion on genetic and evolutionary computation conference companion. ACM, New York, pp 1267–1274
11. Hemberg E, Veeramachaneni K, Deroncourt F, Wagdy M, O'Reilly U-M (2013) Imprecise selection and fitness approximation in a large-scale evolutionary rule based system for blood pressure prediction. In: Proceeding of the fifteenth annual conference companion on genetic and evolutionary computation conference companion. ACM, New York, pp 153–154
12. Knaus WA et al (1981) APACHE-acute physiology and chronic health evaluation: a physiologically based classification system. *Crit Care Med* 9(8):591–597
13. Costa M, Goldberger AL, Peng C-K (2005) Multiscale entropy analysis of biological signals. *Phys Rev E* 71:021906
14. Costa M, Goldberger AL, Peng C-K (2002) Multiscale entropy analysis of physiologic time series. *Phys Rev Lett* 89:062102

# Erratum to: Secondary Analysis of Electronic Health Records

MIT Critical Data

## Erratum to: MIT Critical Data, *Secondary Analysis of Electronic Health Records*, DOI [10.1007/978-3-319-43742-2](https://doi.org/10.1007/978-3-319-43742-2)

The book was inadvertently published without the addition of Edward Moseley in the list of chapter authors in chapter 6 and Shamim Nemati in the list of chapter authors in chapter 29. The erratum book and the chapter has been updated.

**Open Access** This chapter is distributed under the terms of the Creative Commons Attribution-NonCommercial 4.0 International License (<http://creativecommons.org/licenses/by-nc/4.0/>), which permits any noncommercial use, duplication, adaptation, distribution and reproduction in any medium or format, as long as you give appropriate credit to the original author(s) and the source, a link is provided to the Creative Commons license and any changes made are indicated.

The images or other third party material in this chapter are included in the work's Creative Commons license, unless indicated otherwise in the credit line; if such material is not included in the work's Creative Commons license and the respective action is not permitted by statutory regulation, users will need to obtain permission from the license holder to duplicate, adapt or reproduce the material.

---

The updated original online version for this chapter can be found at  
[10.1007/978-3-319-43742-2\\_6](https://doi.org/10.1007/978-3-319-43742-2_6)  
[10.1007/978-3-319-43742-2\\_29](https://doi.org/10.1007/978-3-319-43742-2_29)

---

MIT Critical Data (✉)  
Massachusetts Institute of Technology, Cambridge, MA, USA  
e-mail: [leoanthonyceli@yahoo.com](mailto:leoanthonyceli@yahoo.com)

© The Author(s) 2016  
MIT Critical Data, *Secondary Analysis of Electronic Health Records*,  
DOI [10.1007/978-3-319-43742-2\\_30](https://doi.org/10.1007/978-3-319-43742-2_30)

E1