

Reports of the Research Committee
of the
Society of Antiquaries of London

No. XXXIV

Excavations at Portchester Castle

Volume III: Medieval, the Outer Bailey and its Defences

By

Barry Cunliffe, M.A., Ph.D., F.S.A.

with sections by

D. B. Baker, M.A., F.S.A., A. C. N. Borg, M.A., Ph.D., F.S.A., G.C. Dunning, B.Sc., D.Lit.,
F.S.A., Mrs. A. Eastham, B.A., Mrs. A. Grant, M.A., D. B. Harden, C.B.E., M.A., Ph.D.,
F.S.A., J. G. Hurst, M.A., F.S.A., D. A. Hinton, B.A., R. C. Marks, B.A., Ph.D., F.S.A.
S. Moorhouse, B.A., H. R. Robinson, F.S.A.

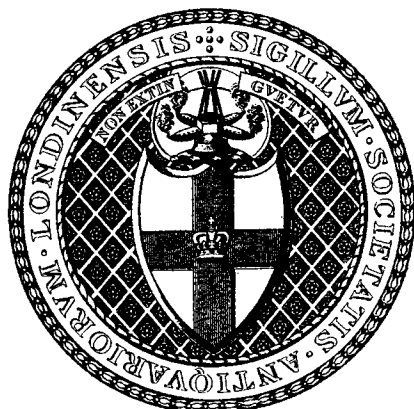

Published by
The Society of Antiquaries of London

Distributed by
Thames and Hudson Ltd

1977

© The Society of Antiquaries of London, 1977

ISBN 0 500 99024 7

PRINTED IN ENGLAND BY
ADLARD AND SON LTD,
BARTHOLOMEW PRESS, DORKING

CONTENTS

	PAGE
List of Figures	v
List of Plates	vii
PREFACE	ix
I INTRODUCTORY SECTION	I
General Introduction	I
The Excavations	I
The Historical Outline	2
II THE DEFENCES	5
Historical Summary	5
The Walls and Bastions	7
The Ditches	9
The Watergate and Adjacent Buildings	10
The Landgate	16
The Postern Gates	21
The Outer Earthwork	24
III THE OUTER BAILEY — AREA EXCAVATIONS	28
Introduction	28
The Buildings of the Outer Bailey	28
The Area Excavation of 1961	29
The Area Excavations of 1964-72	30
The Buildings	37
Building M ₂	37
Building M ₃	40
The Tudor storehouse	42
Gullies	45
The Limekilns	56
Pits	60
Bibliography	95
IV THE OUTER BAILEY — THE SITE OF THE PRIORY	97
The Excavations, by David Baker	97
St Mary's Church, by Alan Borg	105
General Discussion of the Priory, by David Baker	115
Bibliography	120

	PAGE
V BUILDING MATERIALS	121
Louver, by Gerald Dunning	121
Chimney Pots	122
Roof Tiles	124
Ridge Tiles	124
Roof Slates	126
Floor Tiles	127
Bricks	127
Stone Mouldings	127
Wall Plaster	128
Window Glass and Leading, by Richard Marks	128
Bibliography	130
VI THE POTTERY	132
Chronological and Economic Considerations	132
(a) The establishment of a ceramic sequence	132
(b) Production centres, distribution and markets	136
(c) Imported wares and status	137
The Pottery in its Groups	138
(a) Saxo-Norman and medieval	138
(b) Post-medieval, by John Hurst and Stephen Moorhouse	180
(c) The Tudor Green Wares, by Stephen Moorhouse	188
Curfews, by Gerald Dunning	189
Bibliography	192
VII SMALL OBJECTS	194
Armour, by H. Russell Robinson	194
Objects of Iron, by David A. Hinton	196
Objects of Non-ferrous Metal, by David A. Hinton	204
Objects of Bone, by David A. Hinton	207
Objects of Stone, by David A. Hinton	207
Glass, by D. B. Harden	210
Coins	211
Bibliography	212
VIII THE ANIMAL BONES	213
Mammals, by Annie Grant	213
Birds, by Anne Eastham	233
Bibliography	238
IX SUMMARY AND SYNTHESIS	240
Appendix: Commentary on the Sections	246
Index	252

LIST OF FIGURES

	PAGE
1. General location plan	6
2. Portchester Castle	8
3. Portchester and its medieval environment	9
4. Watergate: ground plan	<i>facing</i> 10
5. Watergate: plan of upper storey	12
6. Watergate: elevations	13
7. Buildings adjacent to watergate	15
8. Landgate: ground plan and adjacent areas	17
9. Landgate: plan of upper storey	20
10. Landgate: elevations	<i>facing</i> 20
11. The postern gates	22
12. Elevation of south postern gate, inner face	23
13. Area excavation: all features	<i>facing</i> 30
14. Area excavation: medieval features	<i>facing</i> 31
15. Building M2	38
16. Building M3	40
17. Area excavation: the sixteenth-century storehouse	<i>facing</i> 42
18-	
21. Sections of gullies	46-54
22. Plan of limekiln 2	57
23. Section of limekiln 2	58
24-	
63. Sections and plans of pits	61-95
64. Plan of area A	} <i>between</i> 96 & 97
65. Plan of area B	
66. Plan of area C	
67. General plan of Priory quarter	<i>facing</i> 98
68. Plan of Priory trenches against the church	<i>facing</i> 100
69. Plan of Priory trenches against Roman wall	103
70. Comparative plans of Augustinian establishments	116
71. Louver	122
72. Chimney pots	123
73. Ridge tiles	125
74. Moulded stones	127
75. Window glass	129
76-	
102. Pottery	139-186
103. Curfews	190
104-	
109. Small objects of iron	197-205
110. Small objects of non-ferrous metals	206
111. Small objects of bone and stone	208
112. Small objects of stone	209

LIST OF FIGURES

	PAGE
113. Glass lid	210
114. Histogram of animals represented	214
115. Histogram of bones represented for cattle, sheep and pig	221
116. Age structure of cattle bones	225
117. Age structure of sheep bones	226
118. Age structure of pig bones	227
119. Summary plan of early medieval occupation	242
120. Summary plan of later medieval occupation	243
121. General plan showing position of sections	
122. Sections of landgate: sections 1-3	
123. Sections of watergate: sections 4-6	
124. Sections 7-9	
125. Sections 10-12	
126. Sections 13, 14	
127. Sections 15, 16	
128. Sections 17-20	
129. Sections 21-25	
130. Section 31	
131. Sections of the outer earthwork: cutting 1	
132. Sections of the outer earthwork: cuttings 2 and 3	

} facing 250

LIST OF PLATES (at end)

- I Portchester Castle and village from the air
- II *a* East wall of fort: outer face
b South wall of fort: inner face where building M₃ abuts
- III *a* Watergate from outside
b Watergate from outside
- IV Watergate: middle gate detail
- V *a* Building M₁ at the watergate
b Building M₁ at the watergate
- VI *a* Landgate: east elevation from inside the fort
b Landgate: west elevation, exterior face
- VII *a* Landgate: footings and foundations
b Landgate: footings in relation to Roman gate
- VIII *a* Landgate: outer gate
b Landgate: door to stairs
c Landgate: door to wall walk
- IX *a* Landgate: west wall of upper chamber
b Landgate: east wall of upper chamber
- X *a* Roman south postern gate with medieval blocking
b Medieval south postern gate with blocking
- XI *a* North postern gate
b Outer earthwork
- XII *a* Outer earthwork: section 1
b Outer earthwork: section 1
- XIII *a* Outer earthwork: section 2
b Outer earthwork: section 3
- XIV Pits adjacent to the landgate
- XV *a* Pit 11
b Pit 99
- XVI Area C showing wheel ruts and pits
- XVII *a* Southern part of the fort from the air
b Storehouse footing: detail
- XVIII *a* Storehouse: south end
b Storehouse: north end
- XIX *a* Limekiln 2: general view
b Limekiln 2: detail
- XX *a* Limekiln 2: flue
b Limekiln 2: flue
- XXI *a* Limekiln 1
b Gullies 1, 2 and 4
- XXII Gullies 1 and 2 leading to soakaway pit
- XXIII *a* Soakaway pit 78
b Gullies 31 and 32 in relation to the storehouse
- XXIV *a* Priory excavations: trench P₉
b Priory excavations: trench P₁

- XXV *a* Priory excavations: trench P2
 b Priory excavations: trench P2
 XXVI *a* Priory: garderobe abutting fort wall
 b Priory: garderobe chutes from the outside
 XXVII St Mary's Church: west front
 XXVIII *a* St Mary's Church: western window and arcade
 b St Mary's Church: western doorway arch
 XXIX St Mary's Church: the church from the north-west
 XXX St Mary's Church: the nave looking east
 XXXI *a* St Mary's Church: blocked doorway arch on north side of nave
 b St Mary's Church: capitals of south-west crossing pier: north face
 XXXII *a* St Mary's Church: capitals of north-east crossing pier: west face
 b St Mary's Church: capitals of north-east crossing pier: south face
 XXXIII *a* St Mary's Church: arch of chapel in north transept
 b St Mary's Church: arch of window in north wall of transept
 XXXIV St Mary's Church: exterior, south side showing position of transept
 XXXV St Mary's Church: exterior, south side showing position of west range abutment
 XXXVI *a* Yaverland: decoration of the south door
 b Yaverland: decoration of the chancel arch
 XXXVII *a* Petersfield: detail of arcading above crossing arches
 b Petersfield: decoration of western doorway
 XXXVIII *a* Old Shoreham: doorway
 b East Wittering: doorway
 XXXIX *a* St Mary's Church: font
 b St Mary's Church: font, detail of scroll decoration
 XL Armour fragments 1-5
 XLI Armour fragments 6-11
 XLII *a* Brigandine: sixteenth-century
 b Composite light field armour: sixteenth-century
 XLIII *a* Inscribed wall plaster
 b Iron padlock
 c Lead ampulla
 XLIV *a-c* Moulded stones
 XLV Animal bones

PREFACE

THIS volume, the third in the series dealing with the excavation of Portchester Castle, virtually completes the publication of the first 12 seasons of excavation: all that remains is a few details of the late eighteenth and early nineteenth centuries which will be described in a volume devoted specifically to this period, when Portchester served as a prisoner of war camp. Attention now turns to a consideration of the inner bailey of the medieval castle where excavations are still in progress.

Twelve years of excavation have necessarily involved many people, a few of whom were mentioned by name in the preface to Volume I in the context of my grateful thanks to all who took part in the field work. The preparation of this volume, occupying the year June 1974 to May 1975, has involved a different group of helpers, mostly centred on the Institute of Archaeology at Oxford. Judi Startin, assisted by Susan Rouillard, took responsibility for organizing the excavated finds, Mike Rouillard laboured on the line drawings, lettering the more routine plans and sections which were drawn by the present writer, but undertaking in their entirety the more difficult tasks including the elevations, the finds and a considerable number of the pottery drawings. He also visited the site on several occasions to take photographs of architectural details, many of which are published here. The object photography and the preparation of the publication prints were the work of Bob Wilkins. Tim Ambrose gave considerable assistance in the later stages of compilation, helping to eradicate many of the inconsistencies which might otherwise have slipped through, while Angela Ambrose typed the manuscript, and dealt with the not inconsiderable associated correspondence with her customary efficiency.

Finally we must not forget our debt of gratitude to the specialist contributors whose names are listed on the title page. Their willingness to respond to the production schedule, sometimes at personal inconvenience, has ensured that the presentation of the text to the editor has been accomplished within what I hope is an acceptable period following the end of the first series of excavations.

Barry Cunliffe

Institute of Archaeology, Oxford
17 May 1975

I. INTRODUCTORY SECTION

GENERAL INTRODUCTION

THIS volume, the third in the series of Portchester Excavation Reports, is concerned with the period from 1066, when the castle came under the direct control of the Norman kings, to 1632, in which year it was sold by the Crown to a private individual. The site remained in private hands until 1926, when it passed into the guardianship of the Office of Works, now the Department of the Environment.

In both Volumes I and II, dealing respectively with the Roman and Saxon periods, the site was considered as a whole (Cunliffe, 1975, 1976). For the medieval period, however, it has been decided to divide the excavations into two parts, each presented in a separate volume. The present report, Volume III, deals with the outer bailey and its defences; it will be followed in due course by a volume devoted to a discussion of the buildings of the inner bailey. There are two reasons for this division: first, a report on all the medieval remains would be too bulky for a single volume, and second, while the first phase of the work on the outer bailey was brought to a conclusion in 1972, it is unlikely that the excavation of the castle buildings will be completed until about 1980. To hold up the publication of the earlier excavations until this time would be unacceptable. In these circumstances, separate reports are both convenient and desirable.

In the present volume it will be necessary to refer to some items of the castle's copious documentation, but since only a small part of the total is relevant to the features here discussed no attempt has been made to consider the nature and wider significance of the documentary record: this will be reserved for extended treatment in Volume IV to which it is more appropriate. Here we have relied heavily upon the section on Portchester Castle in *The History of the King's Works* (Brown, Colvin and Taylor, 1963), augmented for the later period by Mr David Baker's researches, the results of which he has kindly made available: references are given to the original sources. Summaries of all the relevant documents, together with a commentary, will appear in Volume IV.

This report has been laid out in a style similar to that of the first two volumes. Some maps and plans from those volumes are repeated here to facilitate use. The section illustrations are also republished together with a commentary on the medieval and early post-medieval layers.

THE EXCAVATIONS

A general description of the excavation programme which yielded the results reported on below has already been given (Volume I, p. 2): here it is necessary only to offer a brief summary.

Work on the defences began with the examination of the landgate and adjacent area in July 1961. The gate was further excavated in Easter 1962, Easter 1963, and again in 1969 and 1970. The more limited excavations of the watergate and the two postern gates were

undertaken during the campaigns of Easter 1962 and Easter 1963. Three sections were cut through the outer earthwork; Easter 1964, July 1968 and July 1972, while the fort ditches were examined in a single trench in June 1963. The main area excavation in the south-west corner of the fort, which forms the bulk of this report, began in 1965, after preliminary trial trenching in the previous year, and continued annually each summer until 1972. It was during this time, in 1969, that Mr David Baker undertook a programme of trial excavations designed to examine the Priory.

Brief descriptions of medieval features have appeared in several interim reports (Cunliffe, 1963, 1966, 1969, 1970, 1971, 1972).

HISTORICAL OUTLINE

The promontory upon which Portchester Castle was built lies at the head of Portsmouth Harbour, some 5 miles (8 km.) from the harbour mouth, dominated throughout the later Middle Ages by the town of Portsmouth (fig. 1 and pl. I). At the time of the Norman Conquest, however, Portsmouth was of no significance; indeed it did not begin to develop as a naval and commercial base until the thirteenth century. The great, safe expanse of Portsmouth harbour was at this stage still commanded by Portchester — where the fortifications built by the Romans in the late third century (fig. 2) survived largely intact, enclosing an area of 8 acres (3·24 ha.) (Volume I, *passim*). These defences later served to protect an early Saxon community and were brought back into defensive readiness in the early years of the tenth century to form one of the burhs integral to the defence of Wessex against the threat of Viking attack (Volume II, *passim*). With the Norman invasion the site passed into the hands of William the Conqueror, by whom it was granted in 'sergeanty' to William Mauduit, sometime before 1086.

In the early Norman period Portchester occupied a strategic position approximately midway between the neighbouring coastal towns of Southampton and Chichester, 13 miles (21 km.) from Southampton and 15 miles (24 km.) from Chichester. Winchester lay 18 miles (29 km.) to the north-west. These three towns were not only of administrative and economic significance but each contained a castle (fig. 3). Portchester in its initial medieval phase is best seen as one of the links in this defensive system.

It is not proposed to discuss, in this volume, the problem of the earliest medieval defences. Indeed, at the time of writing, the excavation of the castle itself is far from complete. Suffice it to say that there is good reason for believing that the site was adapted for Norman military needs in the second half of the eleventh century and continued to be modified thereafter.

The Roman walls served as the outer bailey for the castle but the old postern gates were blocked and the two main gates, the landgate and watergate, were rebuilt (or renovated in the case of the watergate which may be of pre-Conquest origin). The medieval castle was sited in the north-west quarter of the Roman enclosure. By the middle of the twelfth century the keep had been built and the inner bailey wall constructed, thus creating the basic structure which was to dominate the castle thereafter.

Although the twelfth-century works at Portchester were up-to-date by contemporary military standards, the thirteenth century saw little new building of military importance,

largely because Portchester was allowed to become obsolete as the naval town of Portsmouth began to grow. Yet in the early fourteenth century some attempt was made to up-date the old structure to serve as a strongpoint for Edward II in his struggle with the barons, and when, a few years later, the Hundred Years' War broke out, Portchester was again the scene of hasty refortification. It was during this time that the gates were modified and outer earthworks constructed. Further extensive repairs were carried out in 1369 and again in 1385, when hostilities with France intensified once more.

By the end of the fourteenth century Portchester had lost its military importance, but between 1396 and 1399 considerable sums of money were spent on converting the old structure into a comfortable, but still fortified, residence for the king, Richard II, at a time when the sovereign's power was in a precarious state at home. It was as part of this work that the landgate was substantially reconstructed to take on the appearance it still retains today.

For the next 200 years Portchester saw little new building activity. As a Royal residence it was no longer in favour; as a military and naval base it had been superseded by Portsmouth. Some renovations were carried out in 1488 and between 1521 and 1527 a naval storehouse was built in the outer bailey under the order of Henry VIII, but Portchester was too far from Portsmouth to be of much use as a rearward store base. During the latter part of the sixteenth century the castle began to assume a new function: in 1563 it housed casualties of the fighting in France, a use which was to be proposed for the old building on several subsequent occasions.

The last renovations to the castle buildings were undertaken by the Constable, Sir Thomas Cornwallis, at the beginning of the seventeenth century, presumably to provide accommodation for his personal household. In 1632 Portchester ceased to be a Royal castle when it was sold by Charles I to Sir William Uvedale. This date marks a convenient chronological limit for the present volume.

The Roman enclosure, though maintained in good defensive order throughout the medieval period, was at no time heavily utilized, as the excavations of 1961-72, described below, have shown. The castle itself together with its defensive moat occupied 1.7 acres (0.69 ha.), while another substantial area, in the south-east corner, was given over to ecclesiastical uses. It was here in 1133 that Henry I founded a new house of Augustinian Canons quite possibly on the site of an already existing church. Although the Canons of the Priory moved away to Southwick between 1145 and 1153, at least part of the conventual buildings continued to be inhabited, and the church itself was maintained as the parish church, a function which it still performs today.

The rest of the Roman enclosure remained largely as open land, except for a few isolated buildings which were from time to time erected. Such a large well-defended area had obvious attractions as a place of muster for armies about to embark on continental expeditions. On several occasions supplies for such expeditions were amassed here: on other occasions returning armies used the castle on disembarkation. Even after Portchester had ceased to be of defensive significance it still continued to be used in this way. Perhaps the most celebrated occasion was the brief stay of Henry V's army in 1415 before its departure, via Southampton, for Agincourt. It was at the castle that Richard, Earl of Cambridge, Henry, Lord Scrope of Masham and Sir Thomas Gray were discovered plotting to overthrow the king.

In 1563 Sir F. Knollys wrote of the advantages of Portchester for muster, estimating that there was space to house 2000 troops. This was something of an underestimate, for during the civil war 4000 horse and dragoons were quartered here, and at the time of the Napoleonic wars the number of French prisoners in residence frequently reached 5000. It seems likely therefore that throughout the period here under discussion the outer bailey was kept uncluttered, without permanent occupants and buildings, in readiness to house troops and stores in transit. There is some evidence to suggest that for much of the time parts of the area were cultivated (pp. 30-6).

One of the attractive aspects of Portchester today is the village which clusters around three sides of a triangular village green immediately outside the Outer Earthwork. Nothing is known of the origin of the village. If, however, the structures found inside the Roman enclosure, in the immediate pre-Conquest period, represent a full village community, then it could be argued that the Conquest was the occasion upon which the population was moved out of the enclosure and the present village was founded. An equally plausible alternative, supposing that it was a thegn's residence alone which lay within the protection of the fort walls, is that the village for the peasants began to develop outside during the late Saxon period. Excavation within the village may eventually throw some light on the problem.

In the early medieval period Portchester seems to have had pretensions to borough status, though no charter of incorporation existed, nor, later, were members ever returned to parliament. In 1177, however, Portchester rendered an aid of 10 marks (approximately the same as the Hampshire boroughs of Andover and Basingstoke) while in 1258 the records refer to the 'burgesses of the town of Porchester'. On several subsequent occasions the 'men of Porchester' and 'Porchester town' were mentioned, usually in letters patent granting the custody of the town. This continued until the time of Edward IV, after which the descent of Portchester followed that of the manor.

By the middle of the twelfth century the complex of structures and institutions occupying the Portchester promontory must have been at the peak of their development: a newly built castle and a royal monastic establishment within the old Roman fortifications and a developing town outside, yet within 100 years there were signs of stagnation — Portchester had failed to maintain its promise. One reason may have been the departure of the Augustinian Canons, but far more important was the growth of Portsmouth. In a strong, defensible position, Portsmouth commanded both a fine small commercial harbour and the Solent. It began to fulfil not only the military functions of Portchester but, more important, it captured the trade of the area between the established towns of Chichester and Southampton. While Portsmouth continued (and still continues) to expand, Portchester has remained largely unchanged.

II. THE DEFENCES

HISTORICAL SUMMARY

MORE than 600 years of Saxon occupation added little or nothing to the defensive character of Portchester. The walls built by the Romans in the late third century served the Saxon occupants and were maintained in good defensive order throughout the medieval period, the old Roman enclosure acting as an outer bailey for the medieval castle which began to be constructed in the north-west corner in the late eleventh century. The Roman walls and bastions were retained more or less intact, while the gates were rebuilt on their original sites: the ditches too were re-dug versions of their Roman predecessors. The only major modification to be made to the defensive circuit was the construction, in the early fourteenth century, of an outer bank and ditch in order to cut off the promontory from landward approach and to offer an additional line of resistance to any would-be attacker. The details of the individual defensive features are given below (pp. 5–27). Here it is necessary only to sketch the general historical outline within which they must be assessed.

The history of the castle in the first 100 years or so after the Conquest will be treated in detail in Volume IV of this series, since the only direct evidence derives from the excavation of the inner bailey, but it was during this period that the two Roman postern gates were blocked and the landgate totally rebuilt, the watergate having probably been reconstructed in the early eleventh century. By the mid-twelfth century, then, we may reasonably assume that the Roman circuit was secure and in tolerably good defensive order.

Towards the end of the twelfth century various small sums were spent on the defences. In 1173–4 some £9 was paid out for the repair of a bridge and a wall,¹ but this work may have been in connection with the inner bailey defence. Minor and unspecified works continued until the invasion threat of 1193 caused the wall and ditches to be put into defensive order ready to mount mangonels, work which cost £10 13s. 2d.²

Apart from £5 spent on fortification in 1218–19,³ the thirteenth century saw little activity until 1296, when a report given by John le Fauketer on work recently completed included mention of repairs at both the watergate and landgate and on the walls and ditches. There was also a specific reference to a new timber tower, not yet roofed, on the wall towards the sea.⁴ This is the first reference of several to timber fortification being constructed on the walls of the outer bailey.

In the massive building programme of the period 1320–37, during which time the fort was being kept in readiness to repel French attack, work on the defences of the outer bailey was frequently mentioned. It was at this time that both the landgate and watergate were reconstructed (pp. 10–21), and diggers were employed, presumably to re-dig the castle ditches, in 1325 and again in 1326.⁵ Yet in 1335 a survey of the castle⁶ recommended expenditure on the watergate, where the sea had entered the castle and was washing away the

¹ *Pipe Roll 20 Henry II*, p. 138.

² *Pipe Roll 5 Richard I*, p. 133.

³ *Pipe Roll 4 Henry III*, rot. 3.

⁴ E 101/683/12.

⁵ *Pipe Roll 3 Edward III*, rot. comp. 29; rot. 10, m.

⁶ *Chancery, Inq. Misc.* 128 (12).

ground, and on the landgate, which was still unroofed. The commissioners concluded that 'in the outer ward there are many and great defects both in towers and walls'. All this was put right in the next two years. In 1335-6, £20 was spent on works including the repair of the walls, towers and enclosures of the castle,¹ and in the following year, 1336-7,² scaffolding was erected on 12 of the towers (i.e. the Roman bastions) of the outer bailey and on a section of wall, previously inaccessible. At the same time the gates were repaired, a 'false wall' was constructed by the watergate as a defence against enemy galleys and outside the landgate further barriers were constructed together with an 'embattled earthen wall'

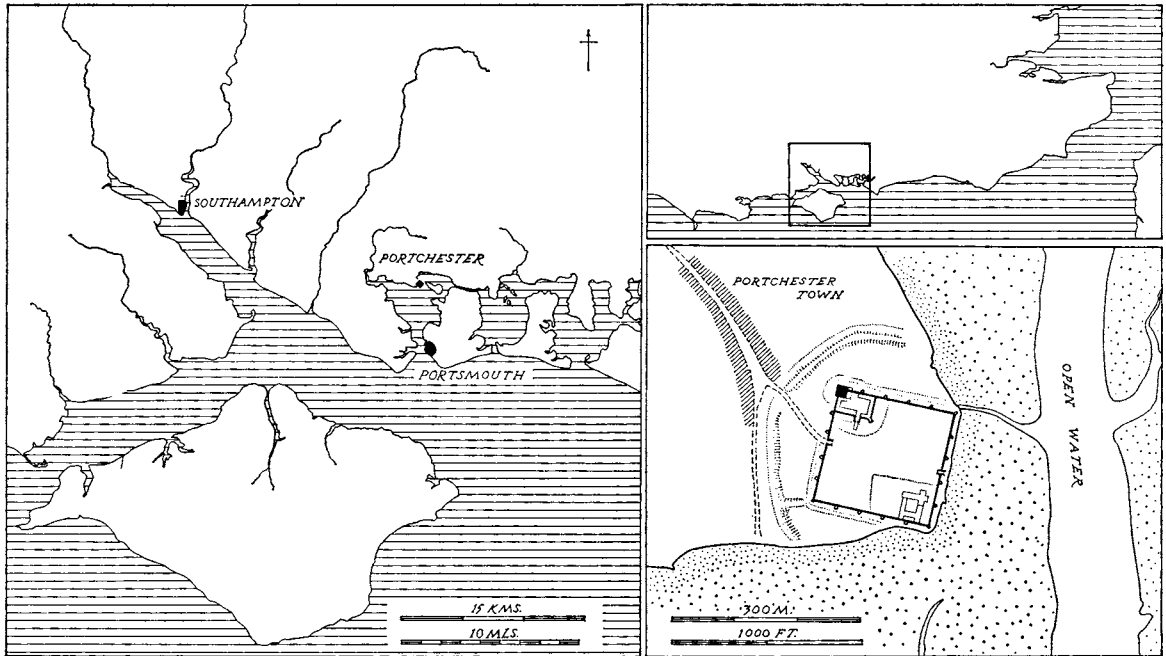

FIG. 1. General location plan

which, it is suggested (p. 27), may reasonably be identified with the Outer Earthwork. Altogether these works give a vivid impression of the efforts expended in an attempt to put the old defensive system into some kind of working order.

Further renovation was undertaken in 1369, when hostilities with France were renewed. Walls and towers were heightened, a section of the wall brought down by the sea was rebuilt, four new stone stairways on the wall were constructed and two more repaired, both gates were renovated and the castle ditches cleared out.³ The fallen wall referred to here is probably the section between the watergate and the north-east corner bastion where, although the Roman core is exposed inside at the base, the upper part is substantially a rebuild. Here, as elsewhere, particularly along the south wall, the characteristic masonry composed of courses

¹ *Pipe Roll 12 Edward III, rot. 15d, m.*

² *E 101/479/18.*

³ *Pipe Roll 41 Edward III, rot. comp. 11d.*

of flints mixed at intervals with courses of rough limestone blocks (pl. IIa) may well be of this period (below). If so the heightening was an extensive undertaking. The four new sets of steps referred to are probably those which served the heightened bastions on the south wall. The two that were repaired may be those at the two bastions south of the landgate which otherwise show little sign of much rebuilding. It is impossible, however, to be certain of these supposed associations.

The refortification of 1369 was the last major work of a defensive nature to be undertaken at Portchester. The great building programme of 1396–9 was concerned largely to provide comfortable and secure residential accommodation for the king rather than to up-date the castle as a military installation. The landgate was considerably modified during this time, but more for display and the comfort of the doorkeepers than for defence.

Thereafter the defences were left to decay. In 1441 the castle was said to be ‘rigt ruynouse and fieble’¹ and nine years later, in 1450, the Constable described to the king ‘the greet ruyne decay and delapidacion of your castel of Porchester . . . the gatez ben broken and avoided bothe within and withoute, the draghtbrugge fallen downe, the towres, turrets and barbicans (before the) gatehous, the walls beth fallen downe . . .’² Nothing, however, appears to have been done to rectify these deficiencies.

Although small sums were spent on the castle during the sixteenth century, the Constables were concerned mainly with the upkeep of the domestic buildings rather than the defences, which were now defunct.

THE WALLS AND BASTIONS

The Roman walls and bastions remained in good order into the beginning of the medieval period, but some time in the late eleventh or early twelfth centuries much of the wall seems to have been reduced in thickness by the removal of up to 3 ft. (1 m.) from its back face (pp. 17–18). This was presumably carried out in order to provide building materials for the Norman defensive works. Significantly, that part of the Roman wall which served as an enclosure for the inner bailey was not quarried but retained its original Roman width of 10 ft. (3 m.).

Throughout the Middle Ages and particularly during the Hundred Years’ War, the walls and towers were many times repaired (pp. 5–7). This may on occasion have entailed substantial rebuilding as seems to have been the case with the section of the east wall north of the watergate, but more usually it involved keeping the walkways in good order and repairing holes in the facing, where frost-shattering had occurred. To distinguish minor patches and repairs of different dates is difficult and largely unrewarding. Extensive medieval refacing is however apparent along considerable stretches of the east and south walls. Characteristically it consists of horizontal courses of flints and limestone rubble giving a banded appearance which, though not entirely regular, may have been intended to have a decorative effect (pl. IIa, b). Many of the battlements were wholly constructed in this manner. Precise dating is impossible but an extensive programme of heightening and rebuilding was underway in 1369.

¹ E 28/70, 2 Dec. 20 Henry VI.

² E 28/80, 6 May 28, Henry VI.

EXCAVATIONS AT PORTCHESTER CASTLE

Of the 20 Roman bastions, one at the north-west corner was replaced by the keep early in the medieval period. Three others, one on the north wall (no. 7), and two on the east wall (nos. 9 and 12), collapsed before or during the medieval period. The scars left by all three were faced in the manner described above and battlements were carried regularly across where the wall had been made good (pl. IIa). Three bastions (nos. 5, 19 and 20) were wholly or partially filled with earth. A small excavation carried out within no. 5 produced a few sherds of gritty cooking pots of early medieval date, implying that the filling was twelfth-century or later and may well have been undertaken for some reason

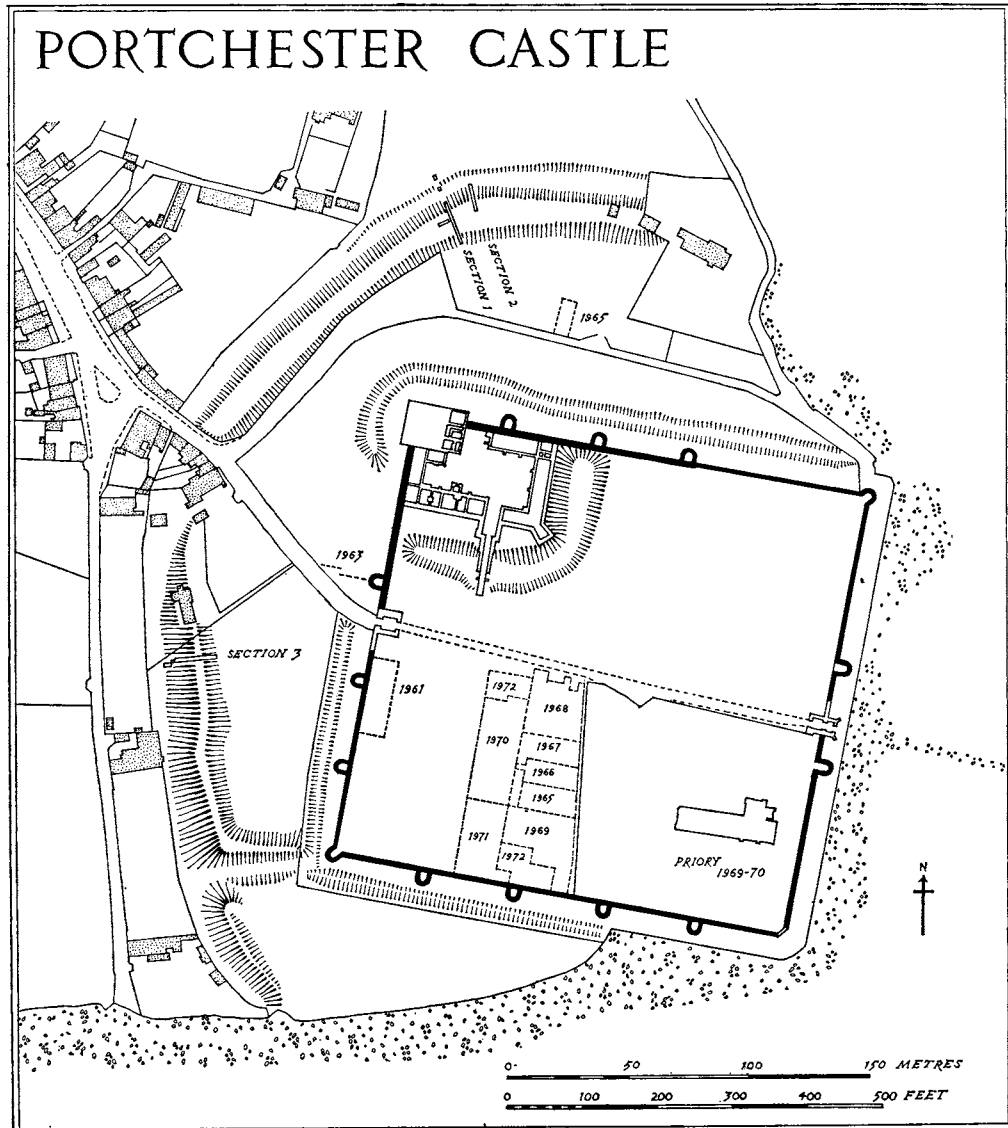

FIG. 2

during the defensive preparations of the early fourteenth century. An alternative is that the bastions were filled to provide a solid platform for the mangonels which were mounted somewhere on the walls in 1193 (p. 5).

THE DITCHES

(fig. 2)

The Roman ditches were allowed to silt up towards the end of the Roman period, and there is no evidence to suggest that they were re-dug at any time during the Saxon occupation. After the Norman conquest the ditches were at least partially cleared out. Unfortunately in the early 1930s they were once more emptied to approximately their Roman profile, almost totally removing the earlier stratigraphy. One length, however, immediately north of the landgate, has escaped the recent clearing operations and remains in its original silted state. A single section cut across the ditch system at this point in front of bastion 1 (fig. 130, section 31) showed that during the early medieval period the outer Roman ditch had been left completely silted while the inner ditch was re-cut to a wide, shallow form. Its

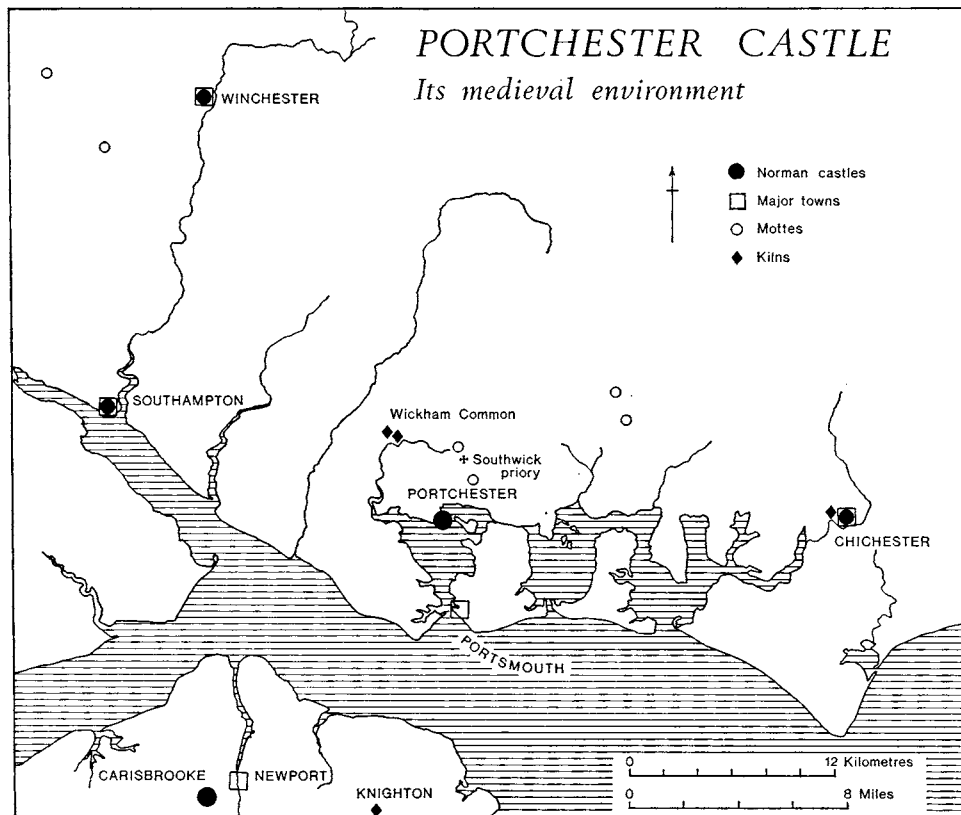

FIG. 3

primary silt contained a few sherds of gritty medieval cooking pots. Above this soil had accumulated. There is a possibility that this sector was cleared out more than once during the medieval period, but the evidence from this single section is ambiguous.

The large collection of unstratified pottery recovered in the 1930 clearing operations contained a quantity of sherds of cooking pots and glazed pitchers of early medieval date which are recorded to have come from the 'castle moats', some presumably from the ditch outside the Roman wall. Since many of the sherds are large and relatively unworn it is reasonable to suppose that they derived from rubbish deliberately tipped into the ditch during a period of relative neglect. Lack of evidence regarding the specific location and stratigraphy of these finds prevents a more detailed discussion of their significance.

For the most part, the 1930 clearance, and therefore presumably the Norman re-digging, followed the line taken by the Roman inner ditch, but on the north and west side of the keep the ditch sweeps out in order to leave a wide berm between the base of the keep and the ditch lip. Here the Norman ditch diggers must have diverged deliberately from the line of the Roman ditch. No archaeological observations survive to demonstrate the relationship or to show if a phase of early medieval clearance existed before the ditch was cut to its present plan.

THE WATERGATE AND ADJACENT BUILDING

(figs. 4-6)

The medieval watergate occupies the site of the Roman east gate which was finally demolished during the eleventh century and replaced by a small square gatehouse built of rubble work with an internal arch constructed of ironstone voussoirs (fig. 4). It has been argued that a late Saxon rather than an early medieval date is appropriate for this structure which has accordingly been described in the Saxon volume (Volume II, pp. 9-14). Nothing of this early gate survives above first floor level.

The first direct reference to the watergate is found in the report of John Le Fauketer who was ordered to visit the castle in 1296 to report upon the building works undertaken by the Custodian.¹ Among the repairs he noted were those carried out at the watergate. No details are given, nor is it possible now to isolate work of this date. Since the total sum expended altogether was small, such works as were accomplished are likely to have been minor.

During the extensive programme of repairs and rebuilding undertaken between 1321 and 1325, a programme which cost in all some £1157, lead was bought to roof the 'two new chambers above the two gates of the castle'.² If, as seems reasonable, it is the gates of the outer bailey that are referred to, the implication would be that the watergate was fitted out with a second storey at this time. This is borne out by an examination of the structure. The window above the inner arch is characteristic of the early fourteenth-century work (fig. 6) as is the new gateway which replaced the original outer arch (pl. IV). Both were ornamented with the same type of shallow double cyma mouldings and both were constructed of cream-coloured Bembridge limestone, which was extensively used in the early

¹ E 101/683/12.

² *Pipe Roll 3 Edward III, rot. comp.* 29.

PORTCHESTER CASTLE

THE WATERGATE — MEDIEVAL

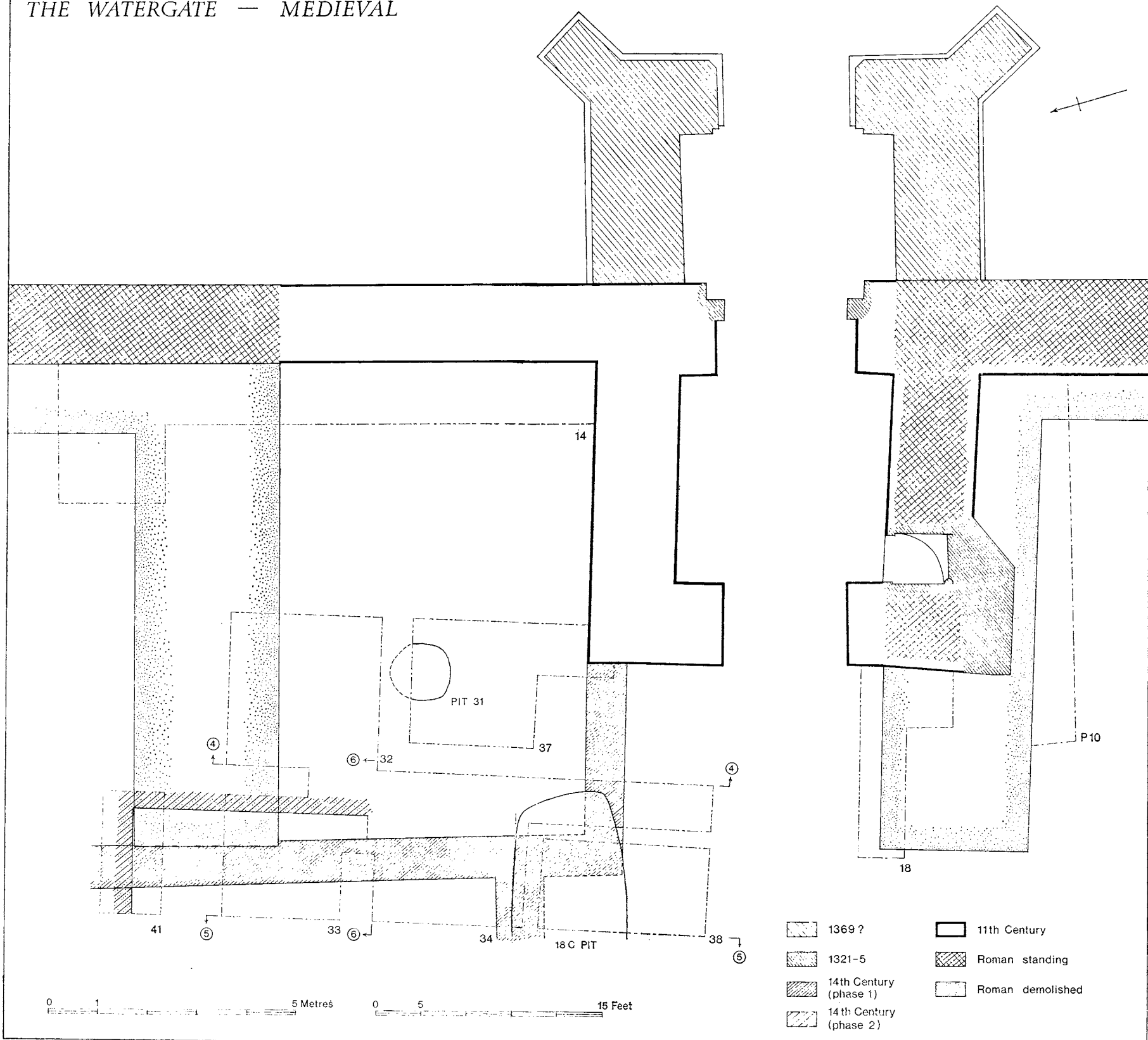

Fig. 4. Ground plan

fourteenth-century construction work elsewhere in the castle. (Stone is recorded to have been brought from the Isle of Wight at this time.) The base of the gate moulding was provided with a bar stop, another early fourteenth-century feature. It was probably as part of this phase of renovation that a spiral stairway was inserted into the south-west corner of the gatehouse, necessitating the thickening of the wall at this point (fig. 4). The stairs were provided with a narrow window slit in the west wall.

The walls of the upper chamber (fig. 5) were thinner than those of the original ground floor, averaging $3\frac{1}{2}$ – $5\frac{1}{2}$ ft. (1.06–1.68 m.) thick, the chamber itself measuring 14 by $17\frac{1}{2}$ ft. (4.27×5.3 m.). It was floored with timber and roofed in the same way, the roof, as we have seen, being covered with lead.

In 1335 the sea undermined the watergate and caused damage requiring an estimated £2 to put right.¹ The work was probably undertaken during the programme of renovation carried out in 1336–7, when repairs of an unspecified nature were mentioned in relation to the watergate.² No distinctive features can now be assigned to this phase, but in all probability only foundations were affected.

In 1369, following renewed hostilities with France, further defensive measures were put in hand at the castle, including repairs at the watergate together with the provision of a new portcullis.³ The final recorded medieval works were undertaken as part of an extensive programme of rebuilding initiated by Richard II. In 1397 we learn that the 'new fabric made at the sea gate' was being roofed⁴ and in the following year plumbers were repairing the lead of the original gatehouse.⁵ It is not immediately clear how these records should be interpreted in relation to the surviving structure. The original gatehouse (eleventh-century with early fourteenth-century modifications), which lay behind the line of the curtain wall, was extended to the east some time during the second half of the fourteenth century by the addition of a new structure measuring the full width of the original gatehouse and projecting 14 ft. (4.27 m.) in advance of the curtain wall (fig. 4). The new work was built of rubble faced externally with carefully cut and dressed blocks of Bembridge limestone, now much eroded by the salt spray, with the external corners strengthened with angled corner buttresses (fig. 6, pl. IIIa, b). The extension was of two storeys with a parapet above built of less carefully faced limestone rubble.

The ground floor was provided with a central doorway, the mouldings of which matched those of the original outer door, remodelled in the 1320s. It had been fitted with a portcullis represented now by vertical grooves in the door jambs and a 'pit' for the counterpoise weight set into the north-east corner of the structure (fig. 5). The lower chamber was roofed with a groined vault, the springers for which still remain in the north-west and south-west corners. Two side windows, much obscured by later work, originally provided a view along the curtain wall to the north and south of the gate.

The upper chamber of the extension appears, from the outset, to have been united with that above the original gatehouse to form a single large room, $17\frac{1}{2}$ by 31 ft. (5.3×9.45 m.). A central window was provided above the outer gate with two side windows giving flanking cover (fig. 5). Another opening in the east wall, now blocked, appears to have been related

¹ *Cal. Inq. Misc.* ii, no. 1472.

² E 101/479/18.

³ *Pipe Roll 41 Edward III, rot. comp.* 11d; E 101/479/21.

⁴ E 101/479/23, *rot.* 2, m 3.

⁵ E 101/479/23, *rot.* 3, m 3.

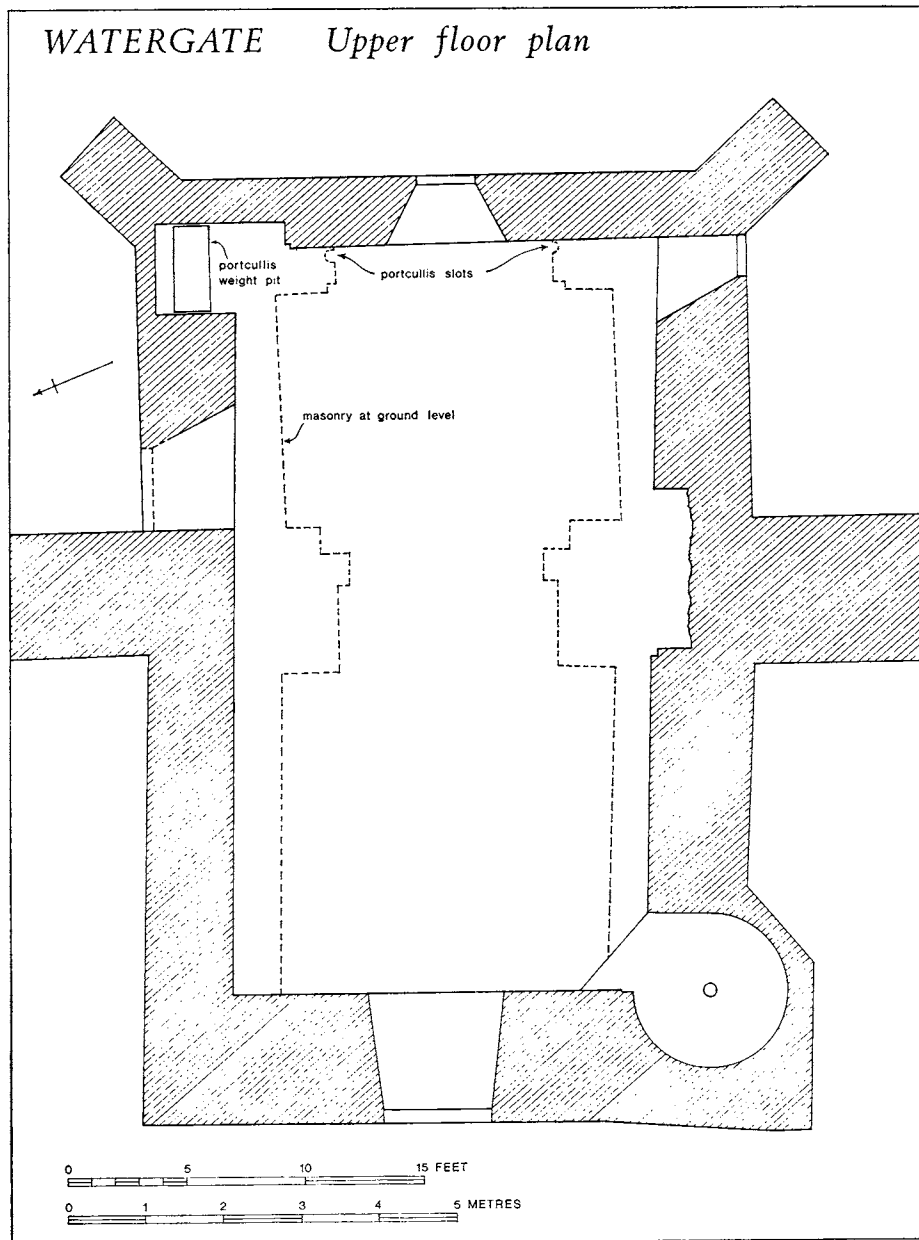
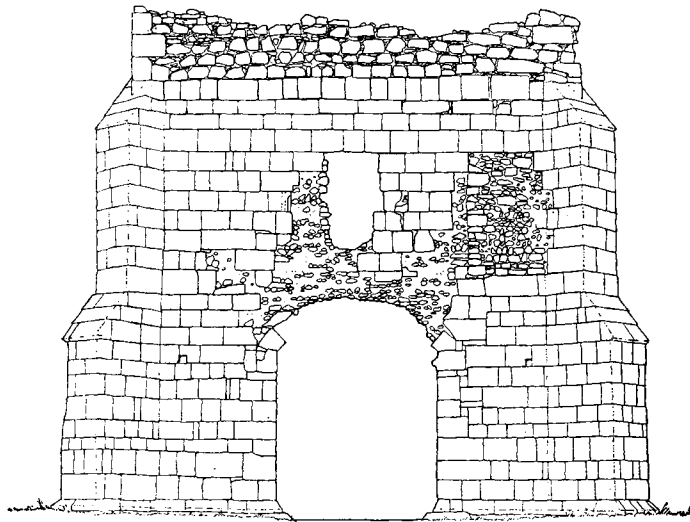

FIG. 5

to the portcullis weight pit. A recess in the south wall may represent the position of a fireplace but rebuilding and refacing has obscured most of the original detail.

It remains to relate the two accounts of building work undertaken in the latter part of the fourteenth century to the structure of the extension. The 1369 work involved repairs and the provision of a new portcullis, while the later work undertaken in 1397 and 1398 mentions

EAST ELEVATION



WEST ELEVATION

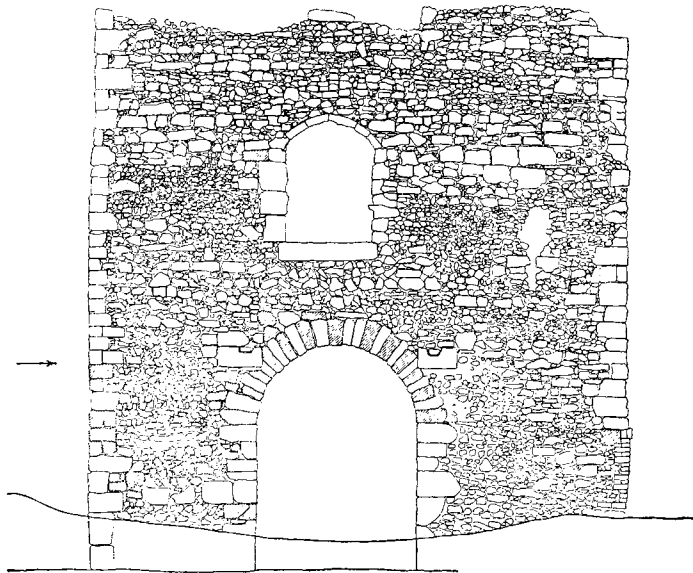

0 2 4 6 12 FEET 0 1 2 3 4 METRES

FIG. 6 Watergate: elevations

the roofing of 'new fabric' and the re-leading of the original gatehouse. Although there can be no certainty, the simplest interpretation is that the extension, with its portcullis, was put up in 1369, while Richard II's works were comparatively minor, being concerned only with reroofing: this would suppose that the words 'new fabric' referred to the structure of 1369. In support of this it should be pointed out that the gatehouse extension is quite unlike Richard II's works elsewhere in the castle both in the style and detail of the building and in the type of stone used. It is more closely related to the works of the early fourteenth century. Furthermore, the gatehouse extension was evidently designed for defensive purposes and would therefore have been more appropriate to the conditions of 1369 than to the circumstances in which the works of 1397-8 were undertaken.

Building M1 Adjacent to the Watergate
(figs. 4, 7, pl. Va, b)

The area immediately to the north of the eleventh-century gatehouse was occupied by a medieval building of which only a part has been examined. The structure made use of the gate wall, curtain wall and the inturned Roman gate wall to form two and a half sides of a room 20 by 32 ft. (6.1 × 9.8 m.) of which the other side and a half were built of limestone blocks set in mortar to form a sill wall 2 ft. (0.61 m.) wide standing to a height of between 1 and 2 ft. (0.30-0.61 m.) above the contemporary ground surface (pl. Vb). Upon this sill was erected a wall of flints set in clay which may have been strengthened with vertical timbers at intervals. None was traced in the surviving section but only a short length of superstructure remained. It could however be demonstrated that no horizontal timber sill beam had existed. It will be evident from the plan that the structure continued both to the north and west of the excavated area: the overall plan is unknown.

The room enclosed in the corner of the gatehouse was floored with a thin layer of mortar averaging 2-2½ in. (0.051-0.06 m.) thick (fig. 123; section 4, layer 7). A mortar spread continued to the south (fig. 123; section 4 and section 5, trench 38, layer 4). West of the north-south wall a layer of clay, topped in places by mortar, had been laid on the contemporary ground surface (e.g. fig. 123; section 5, trench 34, layer 9 and trench 33, layer 15). The only feature recorded within the excavated room was an early medieval pit, pit 31 (pp. 66-7) which was sealed by the floor level and therefore predated the building.

Above the floor of the room there accumulated a thin deposit of grey soil (fig. 123; section 4, layer 6), presumably representing a deposit washed in while the building was still standing but no longer in active use. Then followed the collapse and erosion of the surrounding masonry, giving rise to a mortary filling containing large flints and a quantity of roof slates (p. 126). The pottery from this ground level (p. 165) is in the *developed* or *late medieval tradition* (pp. 134-5) and can be broadly dated to the thirteenth to fourteenth centuries.

The final stage came when a slightly terraced area was cut through the existing layers, removing part of the west end of the Roman inturned wall together with part of the wall of the medieval building described above (pl. Va). The area thus created was revetted on at least two sides by a wall of limestone blocks and flints set in a cream-coloured gritty mortar (fig. 4). The nature and function of this building must await more extensive excavation; all that can be said is that it represents a building phase of late or post-medieval date which

post-dates the use of building M1. To the east of the east wall of this structure was a layer of grey silty soil containing some flints and mortar (fig. 123; section 4, layers 4 and 2). The nature of the layer implies a gradual soil accumulation over a considerable period, during which time the surrounding masonry structure was actually crumbling. Pottery from

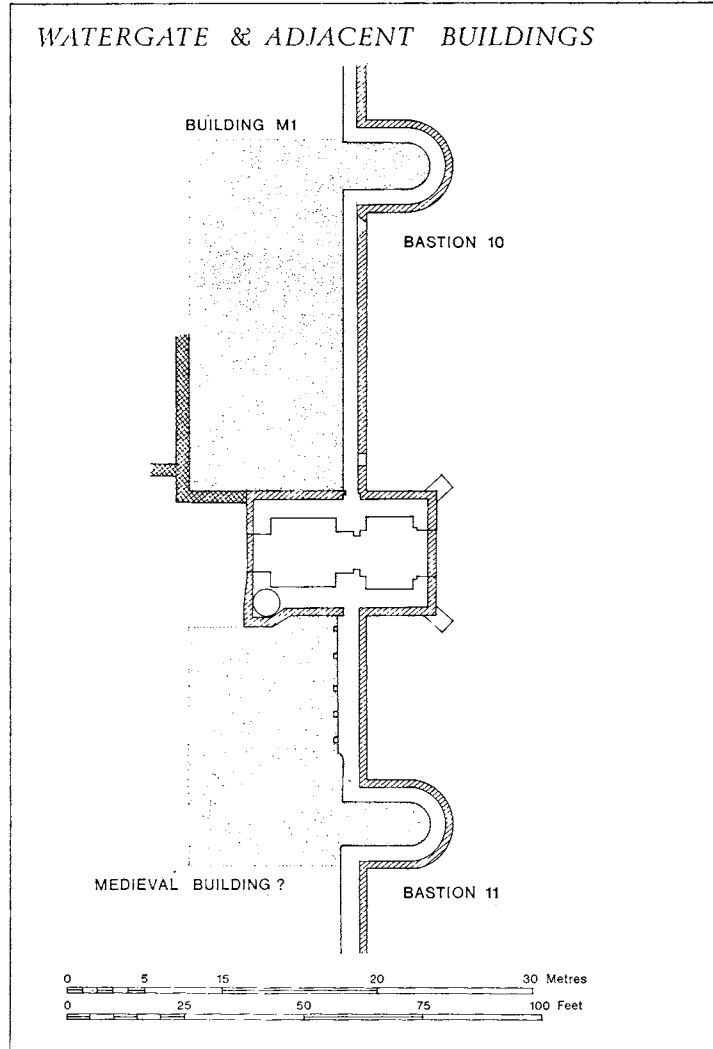

FIG. 7

this soil accumulation (p. 165) belongs to the *ultimate medieval tradition* which must be dated to the fifteenth century (p. 135).

Although nothing of the buildings survives above ground, the parapet level of the curtain wall against which building M1 was erected appears to have been modified, probably in order to create a covered wall integral with the building. Two window openings still survive together with the stairs and doorway providing access from the wall walk to the top of the

gate house (fig. 7). It seems likely that the bastion (no. 10) was also incorporated into the building, but further excavation would be needed to prove the point.

On the south side of the watergate, the cut-back face of the Roman curtain wall supports five corbels which imply the existence of a building in this position, the corbels taking either the horizontal joists of the floor of a two-storeyed building, or the vertical members of a timber roof belonging to a single-storeyed structure. Bastion 11 was probably incorporated in the building since the bastion had been opened out from the back, the newly created external corners being neatly finished with squared stone blocks (fig. 7). Trench P 10 failed to trace any levels or details of the building, most of which were presumably cut away by the extended graveyard (fig. 67).

THE LANDGATE

(figs. 8-10)

The medieval landgate (pl. VI*a, b*) occupies the site of its Roman and Saxon precursors. By the beginning of the medieval period all that remained of the Roman structure was the two massive inturned walls, together with the front (west) walls of the guard chambers which probably supported the original gate arch (or at least a rebuilt version of it). The Saxon gatehouse incorporated all this, the new work consisting essentially of a timber forebuilding (Vol. I, pp. 29-34; Vol. II, pp. 7-9).

The Norman gatehouse was built in masonry on a footing of tightly packed chalk blocks. Its northern wall, however, was simply a refaced version of the Roman inturned wall (pl. VII*a*), the length of the Roman wall determining one direction of the Norman structure. The south wall of the gatehouse was sited along the centre line of the Roman road, with a new length of curtain wall on flint rubble footings, joining it to the Roman masonry on the southern side of the entrance. All this will be clear by reference to fig. 8.

The construction of the new gate was preceded by the demolition of the remaining front walls of the Roman gatehouse to below the contemporary ground level. The shallow robber trenches thus formed were partially filled with mortary rubble (e.g. fig. 122; section 2, layers 9 and 10), while in one place several inches of silty soil had accumulated above (*ibid.*, layer 8). This need not represent a long period of time, since the layer could well have resulted from the mud washing off the adjacent road. From the robber trench filling came a single cooking pot of eleventh- to early twelfth-century date (fig. 95, no. 288).

The rammed chalk footing of the gatehouse was laid in a foundation trench dug down on to the surface of the demolished Roman gatehouse footing, where the new work overlapped the Roman, and into the natural clay where the two diverged. The top of the footings approximated to the contemporary ground surface.

The superstructure of the gatehouse was composed of small iron-stained flints, of a kind that can be collected on the foreshore, set in hard white sandy mortar and partially faced with neatly cut ashlar of Binstead limestone. However, the core of the curtain wall, joining the gatehouse to the Roman work, contained quantities of chalk blocks which are now visible externally due to the erosion of the wall face (pl. VII*b*). The curtain wall at this point was 7 ft. 6 in. (2.29 m.) wide and it was to this width that the Roman curtain wall had been

PORTCHESTER CASTLE

1961 EXCAVATIONS

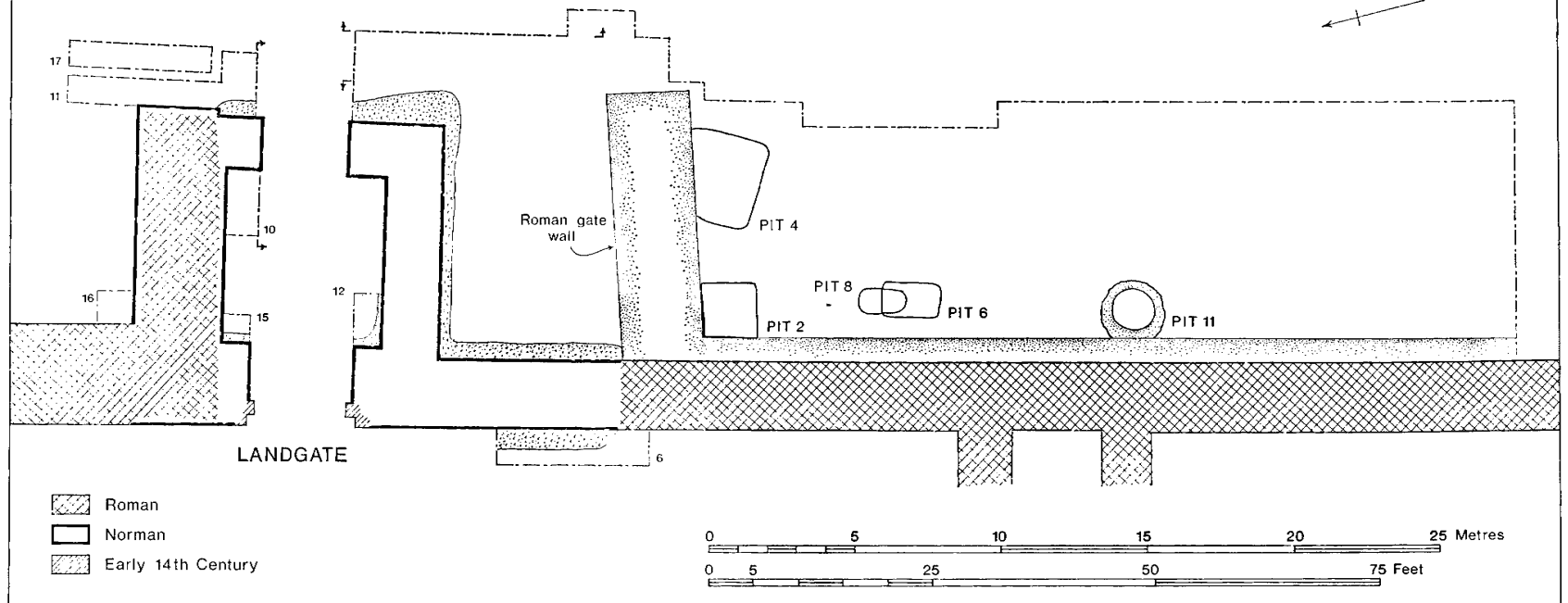

FIG. 8. Landgate: ground plan and adjacent areas

reduced by the removal of 2 ft. 6 in. (0.76 m.) from its back face. The fact that the thinning did not go below the Norman ground surface, taken together with the similarity in thickness of the Norman and reduced Roman walls, strongly supports the view that the quarrying of the Roman walls which the thinning represents was broadly contemporary with the construction of the landgate. It was probably at this time that the Roman south inturned wall was reduced in height to its present level and the space between it and the landgate levelled with mortary demolition rubble. South of the Roman inturned wall a layer of re-deposited brickearth was spread (fig. 122; section 1, trench 1, layer 3), sealing two pits, pits 2 and 4.

The Norman landgate in its original state was a two-storeyed structure. The lower storey accommodated the road which passed through two arches, of which the inner (east) still remains largely intact, the outer having been replaced in the early fourteenth century. Both the outer (west) and inner (east) walls of the gatehouse were faced with ashlar masonry at least to first floor level. The outer face of the east wall, however, suggests that, above this, coursed flint rubble was used with only the corners taken up in ashlar. The side walls (i.e. the north and south walls) were faced in flint work from foundation level. The masonry was plain and without decoration, except for a string course on the inner wall at the level of the springing of the arch, and a simple plinth two courses above ground level.

The end of the refaced Roman inturned wall, which served as the north wall of the gatehouse, was so treated as to create a shallow buttress projecting from the east wall. Within the thickness of the Roman masonry a stairway was constructed leading from a ground level doorway in the north wall to a door which opened into the chamber above: the blocking for this door can be seen from within the ground floor of the gatehouse partly obscured by the late fourteenth-century vaulting. It seems probable that the stairway continued up to the level of the wall walk as it was to do in the fourteenth century. Of the original door by which the stairway was reached, part of the position of the Norman arched opening can still be traced above the facing of the early fourteenth-century door which replaced it (pl. VIII*b*).

Beyond these details, nothing is known of the upper storey of the original gatehouse or of the way in which it was roofed.

There is little that can be said of the date of the gate; the very simplicity of the work prevents close dating on stylistic grounds and the one vessel found in association with the construction phase is too generalized in form to permit of accurate phasing, other than to the late eleventh or early twelfth centuries, nor is there any contemporary documentary evidence. All that can be said is that the securing of the outer bailey is likely to have taken place at an early stage in the post-Conquest history of the site. Since the keep was already in existence by the middle of the twelfth century, a bracket of 1070–1150 would seem reasonable for the construction of the landgate, with a preference for the earlier half of that period.

The first documentary reference to the gate appears in 1296, when John le Fauketer, reporting on works recently completed, referred to the repair of the 'Town Gate'.¹ The first major rebuilding took place as part of the massive programme of renovation carried out between 1320 and 1326. In 1320–1 carpenters were working on the town gate and gatehouse, and during the next few years lead was purchased to roof a new chamber above the

¹ E 101/683/12.

gate.¹ It is to this period that the first recognizable phase of alterations probably belongs. The Norman outer arch was replaced with a new structure built of yellowish Bembridge limestone (pl. VIIIa) ornamented with shallow double cyma mouldings, with a drip mould above resting on carved heads, now much eroded. The door leading to the stairs was rebuilt in a similar fashion (pl. VIIIb). It was probably at this time that the front wall of the upper storey was rebuilt since the ashlar facing above the arch can be seen to be divided from the earlier work below by a levelling course of slate and tile. The positions of the windows of this period have been totally obscured by later works, nor is it possible to be sure what form the roof took. In 1335, however, a survey lists among the castle's defects the roof of the western gate in the outer ward, which still needed to be lead sheeted 'because it was never entirely covered'.² This matter seems to have been put right in 1336-7, when repairs to the landgate were recorded.³

At about this time three large openings were cut through the front wall of the gatehouse above the main arch (fig. 10, pl. VIIIa). In several places the frames of the openings can be seen to cut rather roughly through the adjacent ashlar facing which, it has been suggested above, was reset during the rebuilding of the 1320s. If this is so, the openings must belong to a later stage, but were blocked during the final rebuilding of 1396-9; thus a mid fourteenth-century date is indicated. Functionally, the openings are difficult to understand, unless they were in some way connected with a drawbridge. In this respect it may be relevant to note that among the works undertaken by the Earl of Arundel in 1336-7, reference is made to barriers being constructed in front of the landgate.⁴ Evidently some concern was being shown at this time for the landward defences of the castle. Further repairs to the landgate were recorded in 1369,⁵ but these must have been quite minor.

The final phase of rebuilding came in 1396-9, as part of the great programme of works initiated by Richard II. In 1397 we hear of the 'tower of the great gate of the outer ward' in which, in the same year, masons had made a 'double vault'.⁶ It is evident from a visual inspection that the upper part of the gatehouse was substantially reworked at this time (fig. 10). The three mid fourteenth-century openings were blocked, together with the door which led into the second storey, as a preliminary to vaulting the lower chamber and the creation of a new floor at a higher level. The lower groined vault is still partially preserved, the ribs springing from corbels set in each corner carved in the form of large birds. Two *matrères* were provided on either side.

The original stairway was retained, and a new spiral stair added to lead from first floor level to the roof. Small slits to light the stair were cut through the west wall of the gatehouse. The upper part of the gatehouse was now rebuilt and substantially heightened in a distinctive masonry consisting of rough flint work with the details and corners picked out in blocks of upper greensand, probably derived from the quarries at Bonchurch in the Isle of Wight. The gatehouse terminated in a low parapet above a cornice continuous on all four sides. The coping for the roof line, which can now be seen inside the upper chamber, shows that the late fourteenth-century roof was double valleyed, the valley gutters sloping inwards (towards

¹ E 101/479/17, mm 2-3; *Pipe Roll 3 Edward III*, rot. comp. 29.

² *Cal. Inq. Misc.* ii, no. 1472.

³ E 101/479/18.

⁴ E 101/479/18.

⁵ E 101/479/21.

⁶ E 101/479/23, rot. 2, m 2.

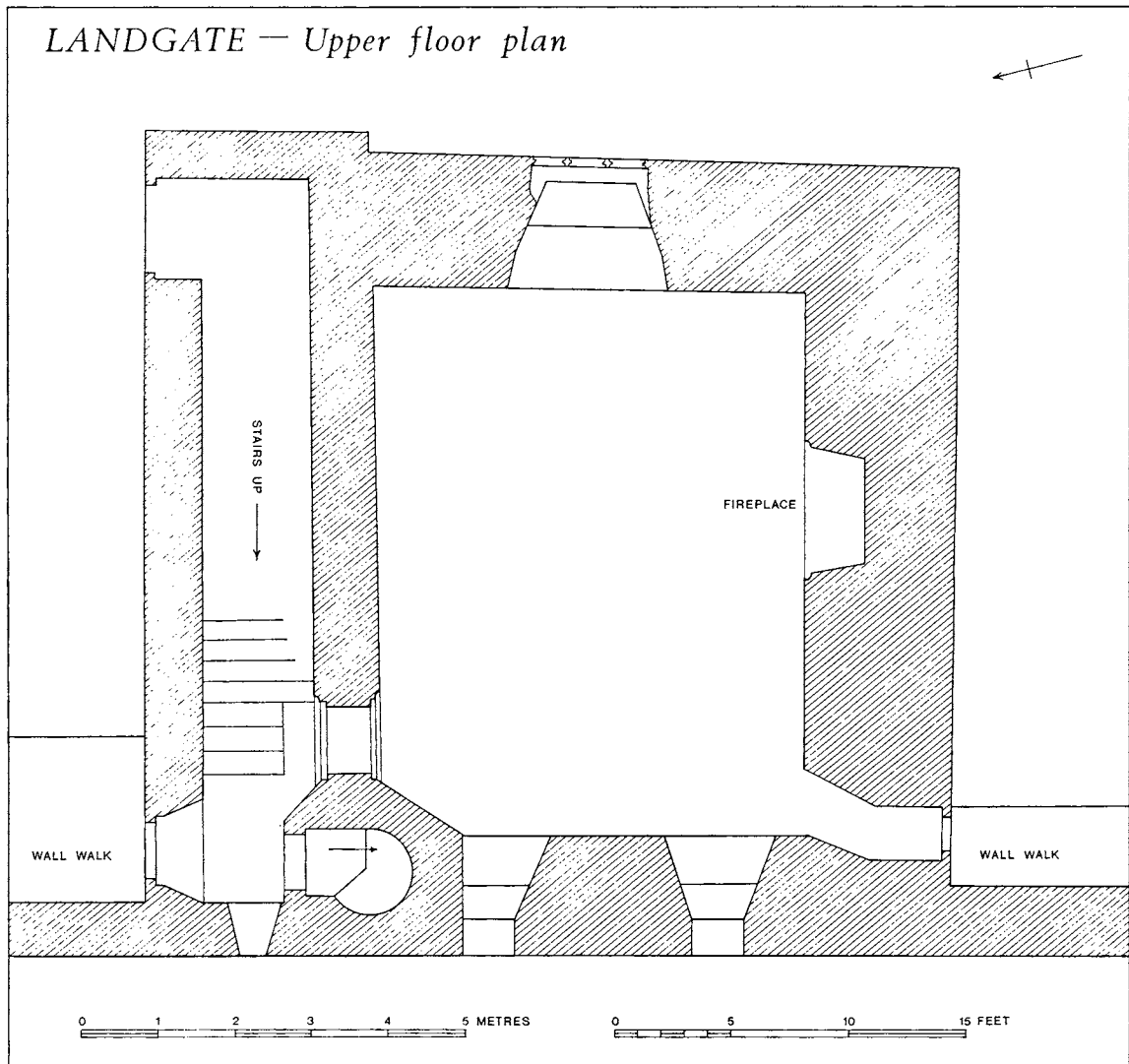
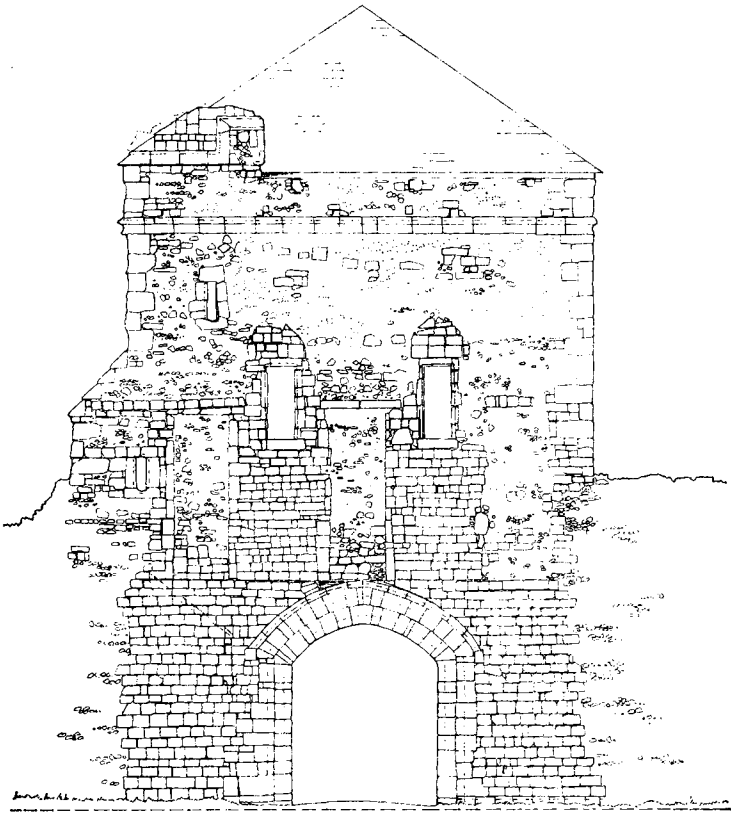

FIG. 9

the east) so that rain water would drain out through two gargoyles which still survive, though in a sadly weathered state (fig. 10). At the north-west corner the parapet wall was increased in height to protect the point at which the spiral stairway emerged to the roof walk.

The upper chamber (fig. 9) was now provided with a double light window in the east wall, with two single lights in the west. All three windows were considerably altered in the seventeenth century, when square-headed openings with deep cavetto moulded mullions were inserted (fig. 10). Nothing of the original late fourteenth-century outer facing survives, but the inner mouldings remain intact (pl. IXa, b). Two doors gave access to the wall walks, one (pl. VIIIc) communicating with a landing at the top of the main stairway, the other opening to a short passage which led straight into the upper chamber. The chamber itself

WEST ELEVATION



SOUTH ELEVATION

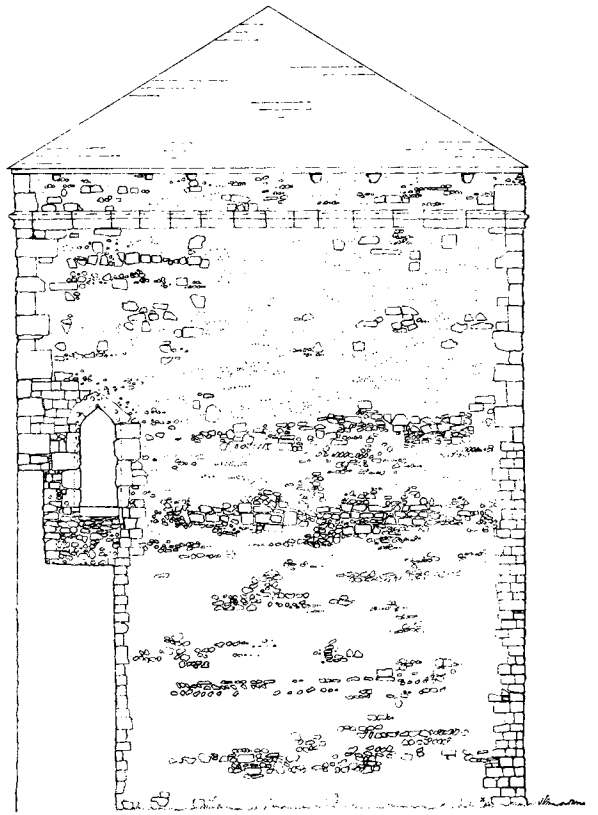

NORTH ELEVATION

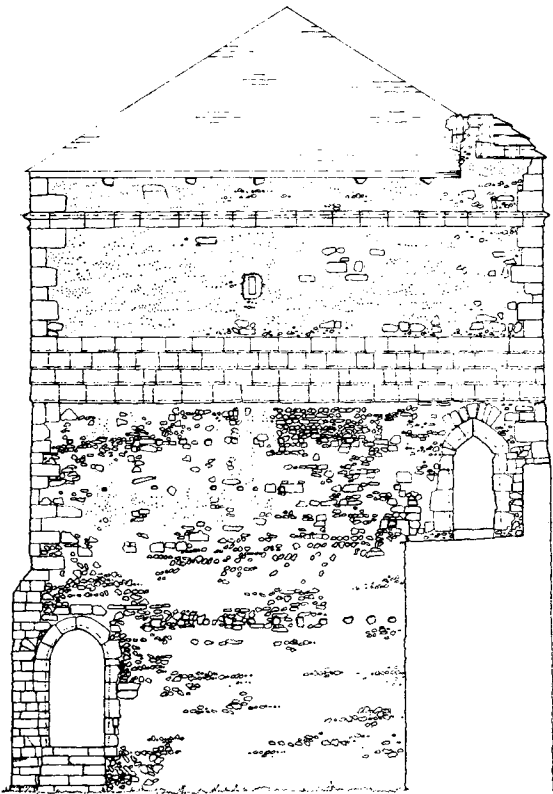

EAST ELEVATION

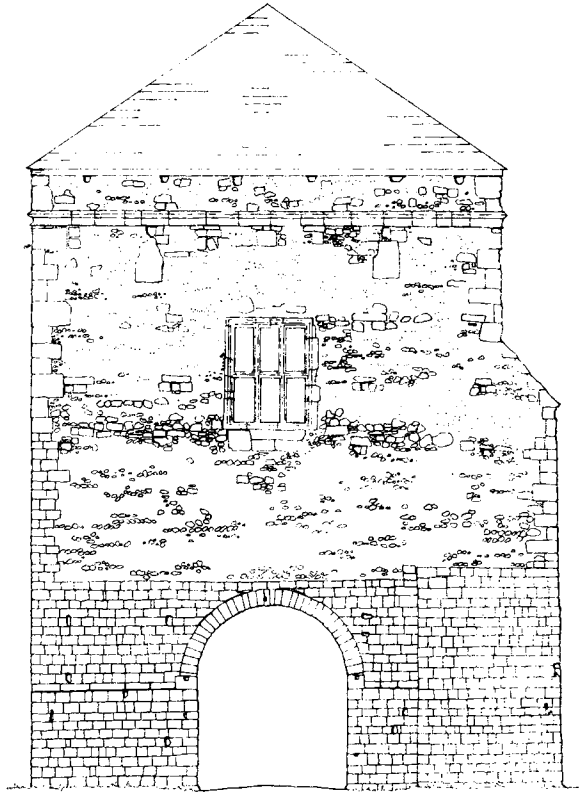

0 5 15 30 FEET

0 1 5 10 METRES

FIG. 10. Landgate: elevations

was without architectural embellishment. It was provided with a fireplace set in the centre of the south wall and was vaulted with a shallow-ribbed vault dividing the ceiling into six compartments. The ribs attached to the east and west walls are the only ones now to survive (pl. IXa, b).

The result of the late fourteenth-century renovations was to convert a functional military gate, albeit of antiquated form, into an imposing entrance, suitable for the royal residence, and sufficiently spacious to accommodate a gatekeeper. Continuous use until early this century ensured that the fabric was maintained in good order. Apart from new window frames possibly inserted by Cornwallis early in the seventeenth century and the pyramidal tiled roof of the late eighteenth or early nineteenth centuries, the landgate has changed little in appearance since 1399.

THE POSTERN GATES

(figs. 11, 12)

The South Postern Gate (figs. 11, 12, pls. X, XI)

The Roman south postern gate, a simple arch some 10 ft. (3.05 m.) wide, probably continued in use throughout the Saxon period (Vol. I, pp. 26–8; Vol. II, fig. 9) during which time soil and rubbish accumulated over the Roman road surface, partly blocking the gateway (fig. 125; section 11, layers 32, 10, 16, 17, 18). Early in the medieval period, the Roman wall was converted into the defence for the outer bailey of the Norman castle (pp. 7–9) involving, among other projects, the blocking of both of the Roman postern gates. At the south postern, as a preliminary to this work, a foundation pit was dug through the overlying soil accumulation down to footing level, and the greensand blocks which lined the Roman entrance were completely removed. Timber shuttering was then erected across the gap, presumably in stages as work proceeded, and the space between was filled with masonry consisting of alternate layers of flints and hard white gritty mortar. After the shuttering had been removed, the lower part of the foundation pit was packed with mortar rubble and a layer of clay (fig. 125; section 11, layers 11, 19, 20). The upper part of the pit soon filled with soil and occupation rubbish. This rapid filling against the inner face ensured that the marks of the timber shuttering, preserved in the mortar, remained sharp and uneroded (fig. 12, pl. Xa).

Broad dating evidence for this operation is provided by a group of pottery from the upper filling of the foundation pit for which a date in the late eleventh or early twelfth centuries is suggested (p. 173). Pit 30, dated to the thirteenth century (p. 144), cut through the filling of the foundation pit. Since the making good of the defensive circuit was probably one of the earliest acts carried out in the Norman period, it is possible that the postern was blocked as early as the late eleventh century or in the opening decades of the twelfth. This, admittedly unsupported, supposition has been used to suggest a date for the pottery from the foundation pit (p. 134).

During the medieval period a new postern gate was cut through the Roman wall 19 ft. (5.8 m.) to the west of the blocked Roman postern. The new gate was 14 ft. (4.3 m.) wide.

EXCAVATIONS AT PORTCHESTER CASTLE

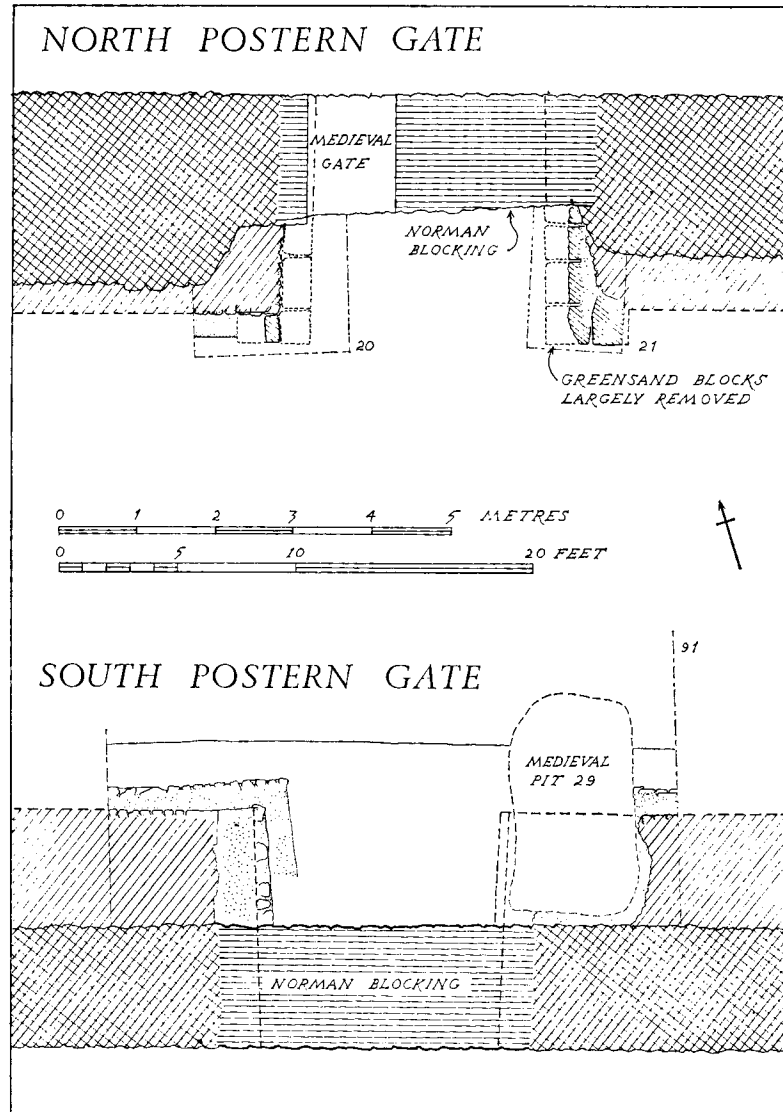

FIG. 11. The postern gates

All that now survives are the lowest blocks which once served as the stone door jambs (pl. Xb).

The remains of a gravelled roadway leading to the gate were found lying above the stump of the projecting Roman wall, and could be traced for about 6 ft. (2 m.) into the fort, after which later levelling had removed all trace. Outside the fort the level of the gate floor can still be seen in the much-patched masonry some 3 ft. (1 m.) above the present level (which was created in the 1930s by the Office of Works to represent the original Roman ground level). The difference in level represents the depth of rubbish accumulation between the Roman period and the medieval.

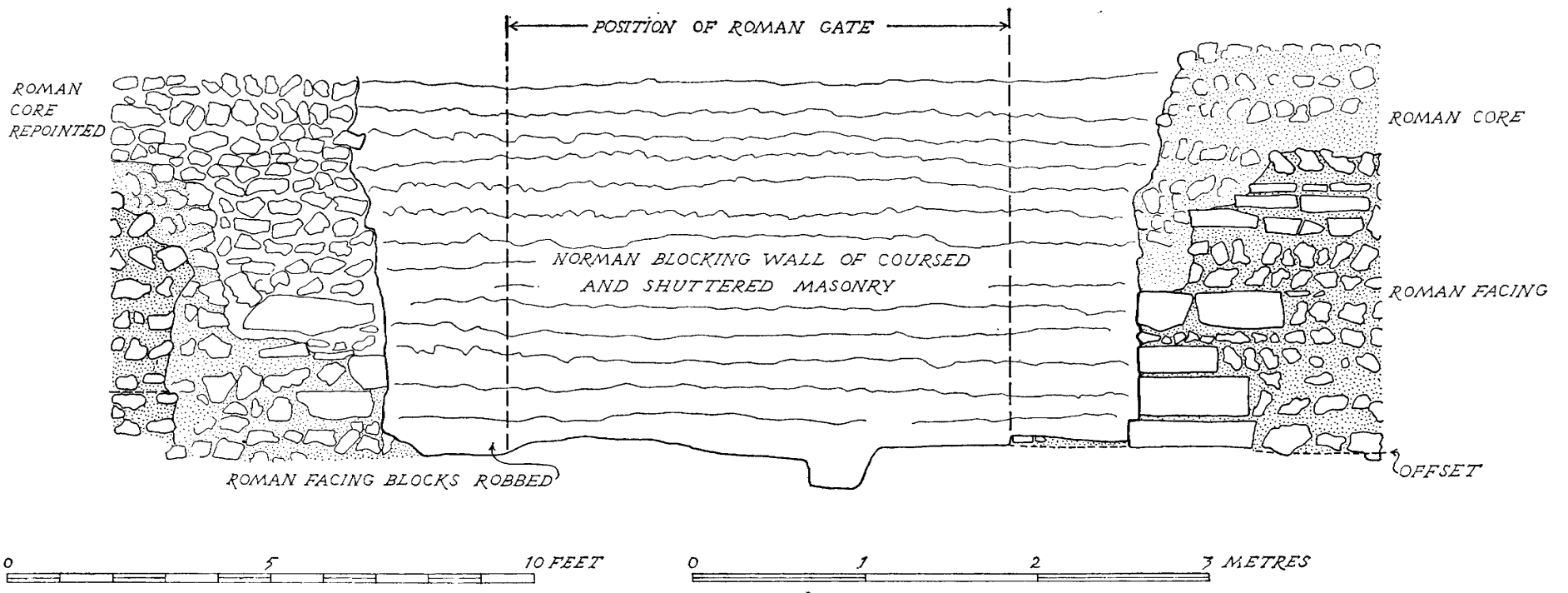

FIG. 12. Elevation of south postern gate, inner face.

At some subsequent date the gate was blocked with rubble masonry. When is uncertain, but the way in which building M3 overlaps the entrance and cuts into the road suggests that the gate had been abandoned and probably blocked by the time that the building was erected in the late thirteenth or early fourteenth centuries (p. 171). There is no dating evidence for the construction of the gate.

The North Postern Gate
(fig. 11)

The Roman north postern gate was subjected to the same treatment as the south postern in the early medieval period: its stone facings were removed and the ragged gap thus formed was blocked with coursed flint and mortar work laid behind timber shuttering. The excavations here were limited to two trial trenches which lay wholly within the foundation pit, the precise extent of which could not therefore be defined. No conclusive dating evidence was obtained, except for a few scraps of early medieval cooking pots.

At a later date a small gate 4 ft. (1.22 m.) wide was cut through the early medieval blocking wall. It was faced with roughly dressed blocks of limestone and greensand and evidently related to a ground surface several feet higher than at present, since one corner has had to be underpinned in recent years (pl. XIa). The date of this gate must remain unknown. It could, as originally suggested (Cunliffe, 1963, 266), have been cut in the eighteenth century to allow easy access for soldiers on guard duty between their barracks outside the wall and the parade ground inside. Indeed, it was certainly used in this period as contemporary prints show. In view, however, of the discovery of the medieval south postern, a medieval date cannot now be ruled out.

THE OUTER EARTHWORK

The promontory upon which the Roman fort stands is protected from the landward approach by a crescent-shaped earthwork which runs from shore to shore enclosing an area of about 19 acres (7.7 ha.) (fig. 2). Williams-Freeman (1915, pp. 394-5) gave a brief description of the earthwork, and in discussion concluded that it should be dated to the prehistoric period (*ibid.*, p. 264). More recently a late Saxon origin has been proposed (Radford, 1970, p. 99) based on the initial trenches dug by the present author (Cunliffe, 1969, pp. 72-4). Now, on the basis of a section cut in 1972, a medieval construction date can be demonstrated.

The earthwork, which consists of a single bank and ditch, is divided into two by the roadway which approaches the landgate. In all probability the present gap marks the position of the original entrance. North of the road the bank has a flat top created by artificial levelling in the late eighteenth or early nineteenth centuries. For the most part, the denuded crest stands 5-7 ft. (1.5-2.1 m.) above the inner ground surface, some 10 ft. (3.05 m.) above the present bottom of the ditch (pl. XIb), which, in this sector, is still sometimes flooded. To the south of the road the rampart, though standing to a height of about 5 ft. (1.5 m.) above the inner ground surface, is of more gentle profile and slopes evenly to the bottom

of the ditch, the outer lip of which is approximately marked by the present property boundary. No artificial levelling is apparent from a surface examination (but see p. 27).

Near to its southern termination the earthwork approaches close to the south-west corner of the fort. At this point a separate bank and ditch, with the bank on the north side, were dug to join the outer circuit to the fort wall. Whether this earthwork is contemporary with the outer defence or whether it is later, is impossible yet to say. At the point of junction of the banks a considerable height is attained, but this by no means proves that the cross-work is later, since the same heightening would occur if both were constructed together. The relationship is, of course, discoverable by excavation.

Excavation

(figs. 131-2, pls. XIIa, b, XIIIa, b)

Three sections have been cut through the earthwork: section 1 in 1964 and section 2 in 1968 sectioned the bank to the north of the road, while section 3, dug in 1972, was cut to the south.

Section 1 (trenches 44 and 45)

The trenches sectioned the earthwork at a point where a later feature had obscured part of its structure (fig. 131) but sufficient survived to show that the bank had been constructed on an original turf line (layer 6) 12-14 in. (0.30-0.36 m.) thick. The first layer to be thrown up from the ditch consisted of turf and topsoil, followed by brown stony clay, representing the redeposited subsoil (later 5), which in turn was covered by a tip of freshly quarried chalk rubble (layer 4) from the lower levels of the ditch.

In front of the bank was a structure 8 ft. (2.44 m.) thick, composed of flints and cream-coloured mortar. It appeared to have been laid on the original turf line and survived to a height of 2 ft. 9 in. (0.84 m.). At the time of excavation it was interpreted as a fronting wall, but this now seems unlikely (p. 27). At a later date (possibly post-medieval) an elongated trench of V-shaped section was cut at right angles through the bank and was filled with tightly rammed chalk. Later still, in the early nineteenth century, the top of the rampart was sheared off, the spoil, combined with tips of rubbish, being thrown out in front of the original structure (layers 7-12).

The water level in the ditch was too high to permit adequate excavation, but two small trial pits demonstrated the existence of waterlaid grey silt immediately below recent superficial deposits.

Section 2 (trench 81)

This trench was deliberately cut close to the position of section 1 in order to examine the fronting 'wall' clear of later disturbances (fig. 132).

The pre-rampart turf line (layers 10a and 11) was found sealing the surface of the subsoil in which narrow plough ruts could be clearly traced. Upon this a dump of turves had been piled (layer 10) before tips of stony clay subsoil were thrown up to form the body of the mound (layer 8). It is probable that the tips of chalk rubble (layer 7) which lay above layer 8 were derived from deeper down in the ditch.

In front of the rampart the trench sectioned what at first appeared to be a robber trench 6 ft. (2 m.) wide, containing soil and chalk eroded in from the sides (layer 6), and sealed by a turf line (layer 4) above which were tips of early nineteenth-century rubbish (pl. XIII*a*). The 'robber trench' had been cut quite late in the history of the site, after the ditch had silted up to an angle of rest (layer 14) and further accumulations of gravelly clay and chalk had formed above (layer 13). Several interpretations are possible to explain the observed facts, the most likely alternatives being:

- (a) that the trench was dug to remove a wall fronting the earthwork and contemporary with its construction;
- (b) that the 'robbed wall' was a later insertion;
- (c) that no wall existed here and the 'robber trench' was dug for some other purpose.

Of these the third now seems marginally more plausible if the stratigraphy of the ditch is considered. The chalk layers interleaved with grey waterlaid silts in layer 16 and layer 15 itself are best explained as erosion from the chalk rubble front of the bank as it weathered back to an angle of rest partially represented in the ditch by the top of layer 14. Layer 13 can then be seen as the spoil from the digging of the 'trench' which removed the chalky front of the eroded rampart as well as the turf and subsoil beneath it. In support of this view it should be pointed out that no mortar of any sort was discovered in the 'robber trench', nor was any found in the adjacent ditch silts. Moreover, the trench was not parallel to the rampart as would be expected if it had once taken a fronting wall.

The trench is dated by a few scraps of post-medieval coarse ware to the seventeenth or eighteenth centuries or later. One plausible explanation is that it was dug as a cesspit to serve the late eighteenth-century barracks built nearby. Its primary fine grey crumbly filling is not inconsistent with this view.

If the 'robber trench' is interpreted as an eighteenth-century cesspit it leaves to be explained the flints and mortar found in front of the bank in section 1. They appear to have been laid deliberately but, it will be observed, they were laid on the original ground surface and not in a foundation trench as one would expect of a load-bearing foundation. Moreover, it was just possible to see in the section (clear of the later disturbance) that the flints were brought to a level surface which was sealed by stony clay (layer 5) very similar to that of which the main rampart was built. In other words, the mortar and flints (layer 13) are best considered as a basal layer in the rampart. This does not explain them, but it disposes of the possibility that they represented a fronting wall. They may have been nothing more than a localized tip of building rubbish derived from nearby construction work.

Section 3 (trench 106)

Trench 106 completely sectioned the rampart, together with the inner lip of the ditch (fig. 132). The rampart survived here only to a height of 3½ ft. (1.07 m.) above the original ground surface (layer 10). A heap of turf had first been piled up (layer 19) followed immediately by various tips of turf, chalk marl, and redeposited brickearth (layers 6-17), all interleaved and discontinuous. Finally a mass of chalk rubble (layer 3), presumably from deep down in the ditch, was piled up over the back (and originally probably the top) of the rampart (pl. XIII*b*).

Only part of the ditch was examined. It was steep-sided and in excess of 11 ft. 6 in. (3.5 m.) deep below the original ground surface. It had silted up naturally at first with grey silty soil containing lenses of stones and chalk (layers 33, 32, 31). Then followed a period of deliberate filling (layers 24-30) with material derived from the rampart and dated, by associated pottery, to the late eighteenth or early nineteenth centuries. It was no doubt at this time that the front face of the rampart was cut back to its present gentle slope to provide material for the filling. Had any fronting feature such as a wall or palisade existed, all trace would have been totally removed during this levelling process. The slight hollow cut into natural subsoil close to the lip of the ditch was entirely a product of the recent levelling.

During the medieval period the back of the rampart had been partly cut away, the scarp thus formed eventually filling with an accumulation of stony soil (layer 4).

The Date and Function of the Outer Earthwork

After the first two sections had been cut, it was immediately apparent that a Roman or pre-Roman date could be ruled out, since from the pre-earthwork turf line quantities of Roman body sherds were recovered as well as a few sherds which could be assigned to the late Saxon period (pp. 178-9). Trench 106 offered more precision. The pre-earthwork turf line produced the usual array of Roman sherds together with a range of coarse gritty and wheel-turned late Saxon wares, but the collection also contained several sherds of early medieval type, including a fragment of a pitcher (p. 179, no. 343), for which a twelfth-century date is possible. Sherds of cooking pots of the same general period also came from the body of the rampart. A date some time in the medieval period or later is therefore indicated for the earthwork. Further precision is provided by the pottery from the layers behind the rampart, for which a date in the fourteenth century is suggested (p. 180). Thus the evidence is clear; the earthwork was put up some time after the twelfth century and probably before the end of the fourteenth. It therefore takes its place as part of the defensive system belonging to the medieval castle.

The general historical context to which this earthwork must belong is the Hundred Years' War, during which time extensive renovations and refortifications were undertaken at Portchester to prepare the castle in the event of a French attack, and to make it secure as a place from which troop movements to the continent could be organized.

During the massive rebuilding programme undertaken between 1320 and 1326, the gates and walls were put in order (pp. 5-7) and a payment is recorded for diggers (*fossatores*)¹ but no particulars are given to help locate this work. There is a further reference to diggers making a ditch around the castle in the autumn of 1326,² but once more no details are given. A decade later, in 1336-7, barriers were being constructed in front of the landgate, together with a ditch and an 'embattled earthen wall'.³ Here at least is a reference to the outer earthwork, but that it was originally constructed between 1320 and 1326 and merely renovated at this time is a possibility that cannot be ruled out. It is unlikely, therefore, that we shall ever be in a position to date the construction more closely than *c.* 1320-40.

¹ *Pipe Roll 3 Edward II, rot. comp.* 29.

³ E 101/479/18.

² *Pipe Roll 3 Edward II, rot. 10, m, ij; Liberate Roll 3, Edward III, m 4.*

III. THE OUTER BAILEY—AREA EXCAVATIONS

INTRODUCTION

THE excavations carried out in the outer bailey were concerned with the examination of two separate areas. In 1961 some 3000 ft.² (278.7 m.²) were excavated against the back face of the Roman west wall just south of the landgate (fig. 8). Later, between 1964 and 1972, an area totalling 40,600 ft.² (3772 m.²) was stripped south of the main east-west road bordered on the east by the west wall of the present churchyard (figs. 13 and 14). In total more than a half of the south-west quarter of the walled enclosure has now been examined.

THE BUILDINGS OF THE OUTER BAILEY

With the exception of the gatehouses and the church of St Mary, which occupies the south-east corner of the outer bailey, no medieval building now survives above ground. A crop mark representing the buried foundations of a storehouse (pp. 42-4) has however long been known and has given rise to much speculation as to the period of its construction, most opinions agreeing (incorrectly) on a late medieval date. The Norden Survey compiled in 1609 shows that the area of the outer bailey was empty by the beginning of the seventeenth century. This fact, taken together with the essentially military nature of the fortifications and the relative lack of documentary reference to the outer bailey, has led to the general belief that the area remained largely open throughout the middle ages and later.

Before the details of the 1964-72 excavation are discussed, a brief summary of the relevant documentary evidence will be given. It must, however, be made clear that it is often difficult to be sure how the sums of money made available to the various Constables of the castle were spent. Even when itemized accounts survive, uncertainty remains as to the exact locations of the various works undertaken. For the most part, it must be assumed that by far the greatest proportion of the expenditure was concerned with the buildings of the inner bailey and with the fortifications: only seldom are activities in the outer bailey specifically mentioned. The apparent lack of recorded expenditure does not however mean that few buildings were erected here, only that they were not paid for by the Crown.

One official building which appears to have occupied the outer bailey was the King's mill. It is first referred to in May 1289, when the Constable was ordered to rebuild the King's mill in the castle:¹ no further details are given, but in 1341 it was reported that the mill pertaining to the castle suffered general decay and flooding and its causeway was almost destroyed by the sea.² The damage was not exaggerated, for in 1376 orders were given for stone and timber to be bought and a new mill to be built.³ It may be relevant here to recall that a few years earlier, in 1335, the sea had washed into the castle through the watergate,

¹ *Cal. Close Rolls* 1288-96, p. 10.

² *Cal. Close Rolls* 15, *Edward III* (1341), 178-9.

³ *Cal. Pat. Rolls* 50, *Edward III* (1376), 344.

and had caused considerable damage. If these two reports refer to the same area of devastation, then the mill may well have been sited close to the watergate.

The castle mill was again referred to in 1397, at the time of Richard II's great rebuilding programme, when a wharf was built nearby to facilitate the unloading of building stone. It seems likely that the wharf lay close to the watergate, so that the stone could be easily transported to the inner bailey. If so, then the implication once more is that the mill was also near the gate. Another location would, however, fit the available descriptions. The mill (and the wharf) may have been sited on the south coast of the peninsula just outside the Outer Earthwork. From here the stone could have been carried to the castle through the landgate. In support of such a siting, it may be remarked that a windmill is shown in this general position in a print of 1784, but for the castle mill to be outside the defensive circuit would seem hardly credible. On balance, therefore, the evidence would seem to suggest that the mill referred to in the texts was near to the watergate, though whether within or without the walls it is impossible to say.

During the renovation of the 1320s, specific reference was made, in October 1324, to 'the new chamber in the outer ward',¹ which was being roofed with tiles provided by William King of Chichester. The whereabouts of this building is problematical. All that can safely be said is that it is unlikely to have lain within the area excavated in 1964-72, since the two medieval timber buildings recovered produced no fragments of tile whatsoever from contemporary occupation or destruction levels. Building M1 at the watergate is a possibility. It was built in the late thirteenth or fourteenth centuries on substantial masonry footings, but its roof (or more correctly its last roof) was slated. The probability remains that the building referred to is still to be discovered.

The final building to be mentioned in the texts, though not specifically as being in the outer bailey, is the storehouse built between 1521 and 1527. The details of this structure, together with its documentation, are fully discussed below (pp. 42-4).

THE AREA EXCAVATION OF 1961

(fig. 8)

The area excavation immediately south of the landgate produced little evidence of medieval activity, with the exception of the digging of five pits (pits 2, 4, 6, 8 and 11). It is suggested above (pp. 16-18) that the Roman inturned gate wall was demolished to its present height, equivalent to the early medieval ground surface, at the time when the Norman landgate was built, and that it was in this period that the Roman curtain wall was thinned by the removal of some 2 ft. 6 in. (0.76 m.) from its back face. It was probably as part of the same phase of activity that a layer of brickearth (possibly derived from the foundation trenches for the landgate footing) was spread immediately south of the Roman inturned wall, sealing pits 2 and 4 (pl. XIV). Over the rest of the trench the medieval period was represented by a layer of grey soil averaging 6 in. (0.15 m.) thick, barren apart from a few abraded sherds of pottery. Evidently the area was kept clear of any recognizable activity throughout the medieval period with the exception of the occasional digging of cesspits.

¹ E 101/380/4.

THE AREA EXCAVATION OF 1964-72

The excavation carried out between 1964 and 1972 in the south-west quarter of the fort entailed the almost total stripping of an area of 40,600 ft.² (3772 m.²). For descriptive convenience it has been divided into three, areas A, B and C (figs. 64-66). Area A, closest to the south wall of the fort, was the deepest stratified, the depth of deposit reaching as much as 7 ft. (2 m.) against the wall. Here distinct medieval layers and ground surfaces could be distinguished. In area B, while some stratigraphy survived, the overall depth of soil accumulation was far less, averaging 3 ft. (0.9 m.). Medieval activity had here churned up the earlier levels and medieval features had cut down into the underlying subsoil. Area C, closest to the centre of the fort, was the most disturbed of all. Medieval wheel (or sledge) ruts had scored the surface of the natural brickearth and the total pre-eighteenth-century soil accumulation was seldom more than 1 ft. 6 in. (0.46 m.) thick. No distinct medieval layers or surfaces could here be traced.

In the following section a description is given of the general medieval stratigraphy in the three areas. This is followed by detailed descriptions of the individual buildings and features (pp. 37-96).

Area A
(fig. 64)

Over most of the area a deposit of grey stony soil had accumulated, separating the distinctive late Saxon occupation levels from a series of physically unrelated but broadly contemporary medieval ground surfaces. In places this layer reached 1 ft. 6 in. (0.46 m.) in thickness, and was rarely less than 1 ft. (0.30 m.) thick. It was entirely mixed, exhibiting no distinctive lenses or surfaces which could have been interpreted as rubbish tipping or occupational activities, nor were there any traces of stone-free soil layers of the kind which would have accumulated in periods of non-activity, when the soil might have been worked through by worms. In other words, the evidence suggests a lack of domestic activity but no period of rest. Such conditions would prevail if the area had been subject to extensive agricultural disturbance giving rise to a depth of churned up 'ploughsoil'. The soil layer thinned out considerably towards the wall, where the underlying Saxon occupation layers were preserved much higher, exactly as one would expect if the area had been ploughed, the plough being unable to approach the wall too closely.

Gully 16, which divided area A, seems to have served as a significant boundary at this time, for the area to the west of it did not exhibit so consistent a depth of ploughsoil but instead the Saxon layers were fairly well preserved in some patches.

The ploughsoil deposit contained quantities of late Saxon pottery mixed with a small percentage of medieval sherds of the eleventh to thirteenth centuries. The time range represented by this material would be consistent with the length of time needed for the formation of a layer of this thickness.

Above the ploughsoil it was possible to recognize a series of ground surfaces. To the west of gully 16 a thin spread of lime mortar, no more than 1 in. (0.03 m.) thick could be traced (trench 101, layer 28). The mortar had clearly been dropped or spread wet upon the contemporary ground surface, which showed no sign of preparation. It thickened towards

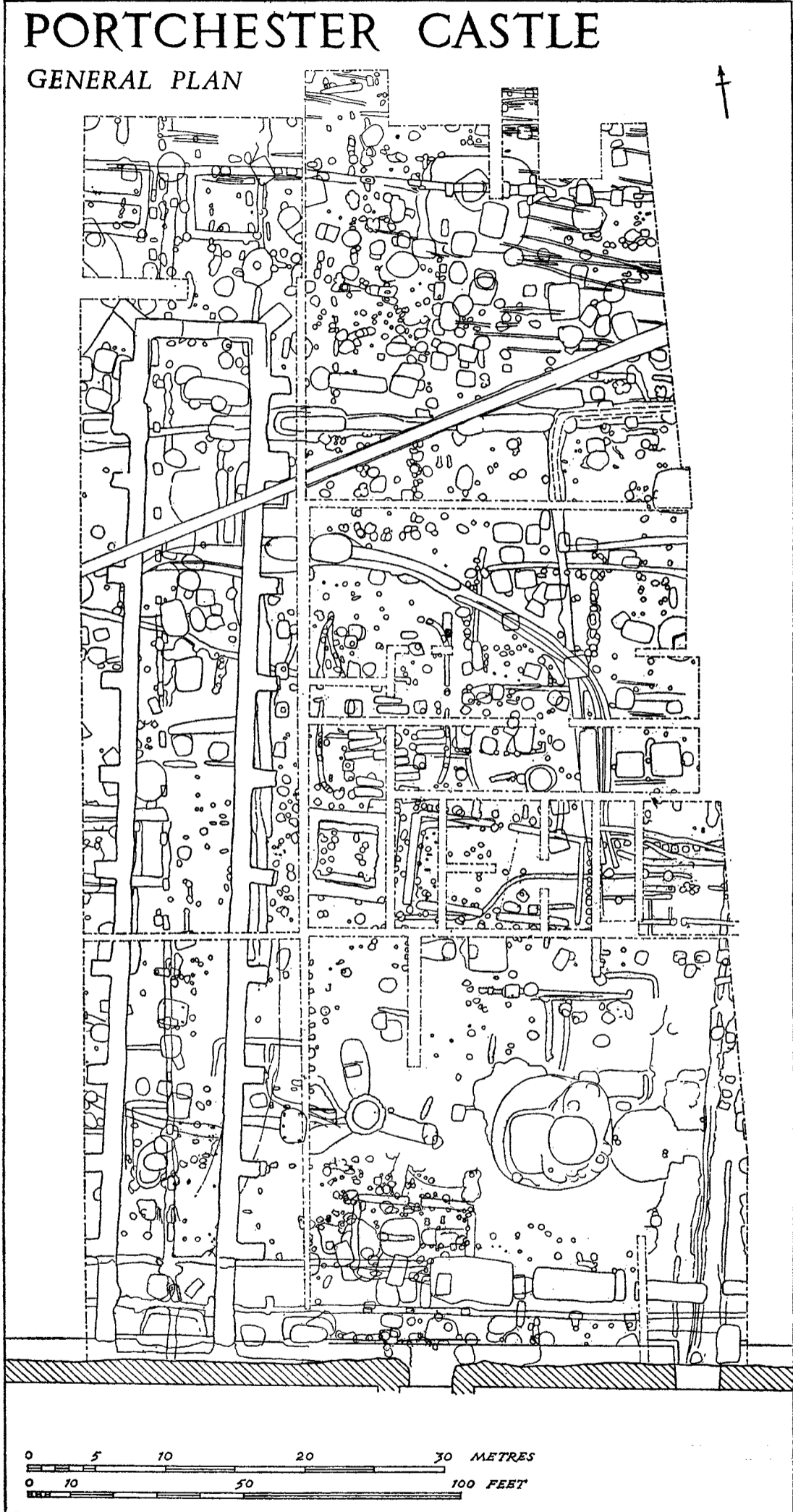

FIG. 13. General plan summarizing features of all dates

PORTCHESTER CASTLE

MEDIEVAL

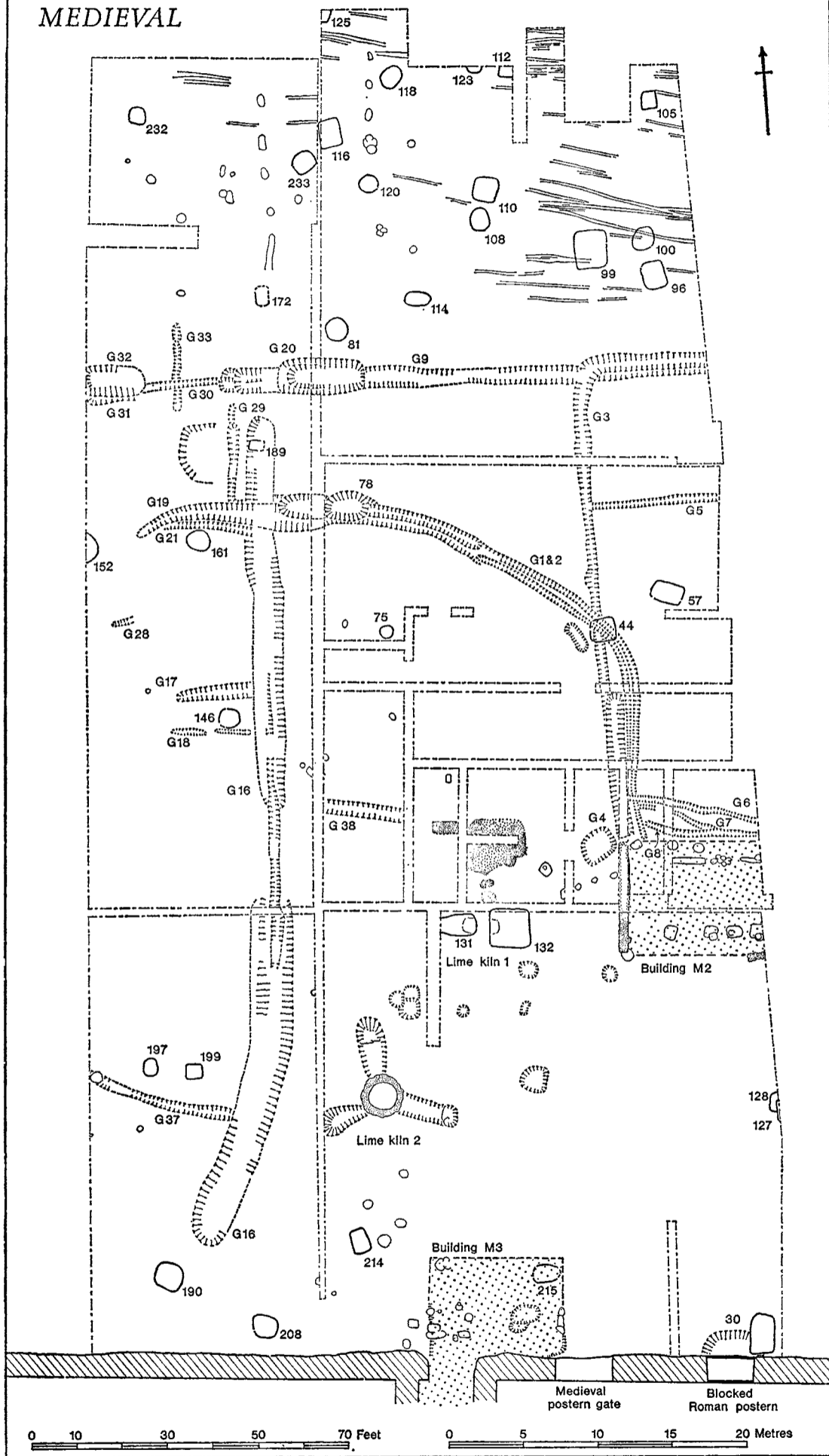

FIG. 14. General plan of area excavation showing all medieval features

the western extremity of the excavation. No reliable explanation can be offered unless it represents mortar mixing, possibly associated with a nearby, but unexcavated, limekiln.

Immediately to the east of gully 16, two distinct surfaces were recognizable. They are best demonstrated in fig. 124, section 9, the lower appearing as trench 101, layer 47, the upper as trench 101, layer 57, and trench 103, layer 114. The lower surface could be traced, albeit discontinuously, over most of area A (e.g. fig. 126; section 14, layer 7), either as simply a change in soil texture between the ploughsoil below and what came above, or as thin layers of gravel, flints, mortar, clay or occupation debris. These more definite layers are shown in plan on fig. 64, together with a series of shallow hollows and isolated postholes with which they were broadly contemporary. The horizon must represent a period after the agricultural activity had ceased, when the area was open and subject to varying uses. It was probably during this period that the new south postern gate was cut (pp. 21-4) and building M2 was constructed. Pottery was not particularly plentiful, except in the vicinity of building M2, but taken together would suggest a date within the mid-thirteenth to mid-fourteenth centuries.

At the end of this period, after a little soil had accumulated in places, limekiln 2 was built (pp. 57-60). The thin spreads of lime associated with it were traceable in the immediate vicinity, thus defining the contemporary ground surface. If it is accepted that the kiln was built to provide lime for the extensive renovations to the walls carried out in 1369 (p. 59) a useful chronological horizon is established. It was probably at about this time that the final recut version of gully 16 (pp. 49-51) was filled with clay, and clay was spread out over the adjacent area (fig. 64). This may also have been the period when the south postern gate was blocked, some time after which building M3 was erected (pp. 40-2). It is however impossible to link all these activities stratigraphically.

After this, a layer of soil some 9 in. (0.23 m.) thick accumulated over the entire area. It was totally devoid of structural features and produced practically no pottery. The stony nature of the layer, however, suggests that it may have been the result of cultivation. Eventually disturbance ceased, and a stone-free turf line formed. The turf line was very well preserved where it was sealed by the building layers associated with the sixteenth-century storehouse, but beyond, to the east, it had been removed by later activity. The upper ploughsoil (?) and its sealing turf line must represent the period from the end of the fourteenth century until 1520-7, when the storehouse was erected (pp. 42-4).

The tips of clay and soil derived from the foundation trenches of the storehouse represent the last distinctive layer before building activities commenced in the eighteenth century.

The buildings, pits, and gullies in area A are described in the relevant section below. Here it is necessary only to list the miscellaneous features and postholes.

Details of Features and Postholes (fig. 64)

- Feature M1 (a) Circular hollow 4 ft. (1.22 m.) across, *c.* 13 in. (0.33 m.) deep below contemporary surface. Filling of dark soil and flints.
Trench 90, layer 28.
- (b) Elongated hollow, 6 in. (0.15 m.) deep below contemporary surface. Filling of flints and soil.
Trench 90, layer 19.

- Feature M1 (c) Circular hollow 5 ft. (1.52 m.) across, up to 15 in. (0.38 m.) deep. Filling of flints and black soil.
Trench 90, layer 34.
- Feature M2 Circular hollow 3 ft. (0.91 m.) across, *c.* 15 in. (0.38 m.) deep. Filled with light yellow-brown clayey soil and flints.
Trench 89, layer 18.
- Feature M3 Circular hollow 6 ft. (1.83 m.) across, *c.* 9 in. (0.23 m.) deep. Filled with large flints and dark brown soil.
Trench 89, layer 9.
- Feature M4 Irregular hollow 7-10 in. (0.18-0.25 m.) deep. Filled with flints and black soil.
Trench 89, layer 14.
- Feature M5 Large sub-circular hollow up to 8 ft. (2.44 m.) across and 2 ft. (0.61 m.) deep. Filled with occupation rubbish, flints and black soil.
Trench 89, layer 56.
- Feature M6 Circular hollow 6 ft. (2 m.) across, *c.* 12 in. (0.30 m.) deep. Filled with black earth, stone and flints.
Trench 88, layer 8.
- Feature M7 Irregular hollow cut to a maximum depth of 1 ft. 4 in. (0.41 m.). Filled with light brown mortary soil containing fragments of daub.
Trench 107, layer 28.
- Feature M8 Semi-circular hollow cut against the face of the Roman wall to a maximum depth of 12 in. (0.30 m.). Filled with light brown mortary soil containing fragments of daub.

Postholes (fig. 64)

The postholes belonging to and in the vicinity of buildings M2 and M3 are described in the section dealing with those buildings (pp. 37-42). Besides these structures, the following postholes could be shown to be of medieval date by virtue of the ground surfaces from which they were cut, or by the pottery found in their fillings.

Posthole	Diam. (in.)	Depth (in.)
734	12	20
804b	26	18
813b	18	22
861	24	26
868	7	14
869	16	32
1190	22	30
1191	24	26
1192	28	30
1193	8	14
1194	24	9
1195	14	10
1196	14	11

- Slot 1 Short length of slot with flat bottom and steep sides, 18 in. (0.46 m.) deep and 22 in. (0.56 m.) wide at the top. Filled deliberately with grey soil and tips of brickearth. It may have contained a structure against which the mortar was piled (fig. 126; section 13: the slot fill is 15a). When the structure was removed and the slot deliberately filled, a thin lens of mortar washed down over the filling. The nature of the structure remains unknown.

Area B
(fig. 65)

Over most of area B a uniform layer of stony grey soil containing medieval pottery was found to merge down to the Roman soil accumulations, there being no clear distinction within the layer to represent late Saxon or medieval ground surfaces. The layer was essentially a mixed ploughsoil of the type found in area A both below and above the fourteenth-century ground surface. In an area of shallow stratigraphy such as this, agricultural activity of the early medieval period is likely to have destroyed the late Saxon floor surfaces and occupation levels, while similar activity in the later medieval period may well have removed ground surfaces of the fourteenth century. In other words, the absence of recognized ground surfaces here does not mean that they did not exist, but simply that they did not survive. Indeed there is no reason to suppose that the sequence observed for area A was not generally true for area B.

The exception to these generalizations lies in the southern part of the area closest to area A. Here part of the floor level of building M₂ survives (pp. 37–40) together with the remnants of a flint and mortar structure, hearths and an area of occupation rubbish tipped into a shallow hollow. A date in the mid-thirteenth to mid-fourteenth centuries can be argued from the few associated sherds (p. 170). These isolated levels are all that remain of the medieval ground surface so well preserved to the south.

The form and function of the flint and mortar structure are difficult to ascertain. It appeared to consist of two roughly parallel 'walls' of loosely mortared flints, with a spread of mortar in between. There were no foundations, and the upper surface had been disturbed by subsequent agricultural activities. Whether it was in some way connected with the limekiln immediately to the south it is impossible to say, but one possible explanation is that it was some kind of raised platform for the storage of the lime before it was carted away.

Apart from the few postholes belonging to building M₂ (described below p. 39) and the isolated posts which could be shown to have been cut from the medieval level (fig. 65 and listed here), there was a large number of other postholes discovered in the area (fig. 13). Many of them can be shown to belong to late Saxon buildings (Vol. II, pp. 14–60), and it is probable that most of the remainder were of late Saxon date, but the possibility that some were medieval cannot be ruled out. They are not individually planned and described here, but will be found on the plan of the Saxon features of area B in Volume II (fig. 102). The loss of the ground surface from which they were dug usually renders dating impossible.

The other medieval features of area B consist of gullies and pits which are described in detail below.

Over the western part of the site the ploughsoil was sealed by the pre-1520–7 turf line, observed also in area A, which was in turn preserved by the layer of soil and clay derived from the digging of the foundation trenches. In some patches, however, particularly in trenches 96 and 97, the turf line had been partly removed during the early sixteenth-century building operations. In the western part of trench 71 a distinctive pebble layer was found immediately below the turf line. This may have been the result of worm action concentrating small stones after the continuous working of either a particularly stony soil or a ground surface upon which gravel had been sprinkled. Similar but less dense concentrations were observed elsewhere on the site.

The construction layers of the sixteenth-century store building, consisting of spreads of loose mortar and redeposited clay and soil from the foundation trenches, were clearly distinguishable. In one place, immediately east of the building in trench 95, an area of turf which had begun to form during the sixteenth century still survived, but elsewhere the sixteenth-century levels were disturbed or removed in the eighteenth century.

Details of Features and Postholes (fig. 65)

- Feature M₉ Irregular, up to 7 ft. (2.13 m.) across and 12 in. (0.30 m.) deep. Filled with occupation rubbish, including oysters, bones and pottery.
Trench 54, layer 3a. For pottery see p. 171.
- Feature M₁₀ Elongated hollow, 8 ft. (2.44 m.) long, 2½ ft. (0.76 m.) wide and 9–12 in. (0.23–0.30 m.) deep. Filled with grey soil and large flints.
Trench 62, layer 15.
- Feature M₁₁ Sub-rectangular hollow approximately 12 ft. (3.66 m.) across and 1 ft. 3 in. (0.38 m.) deep. Filled with dark soil and flints.
Trench 98, layer 47; trench 97, layer 51.

Postholes (fig. 65)

The postholes shown on the plan and listed below were either seen to have been cut from medieval levels or contained medieval postherds. Postholes belonging to building M₂ are listed below (p. 39).

Posthole	Diam. (in.)	Depth (in.)
268	36	3
277	17 × 26	13
297	10	2
430	9	6
446	24	7
451	10	3
503	12–22	6
575	30–32 (post 10)	5
1197	12	6
1198	12	8
1199	12	7 +
1200	13	14

Area C
(fig. 66)

Apart from discrete features such as pits and gullies, practically no medieval stratigraphy survived in area C. All that remained over most of the site was a uniform layer of grey stony soil 9–12 in. (0.23–0.30 m.) thick, representing the constant churning and mixing of soil deposited in Roman, Saxon and medieval times. Roman and late Saxon pottery was plentiful throughout, but medieval sherds occurred, sometimes at the bottom of the layer close to the surface of the natural brickearth.

South of the line of gullies 3, 9 and 32, the stratigraphy was much the same as that of area

B. Immediately to the south of gully 32 a pile of chalky marl and flints had been thrown onto the medieval ploughsoil, no doubt when the gully was re-dug in its penultimate stage (fig. 127; section 16, trench 98, layer 14a). A similar layer was observed on the south side of gully 9 (fig. 127; section 15, trench 73, layer 9).

North of the gullies the disturbance of the early levels had been at its most intense. Not only was the area heavily dug into by pits and postholes of all dates, but it had also been subject to considerable traffic up to the early nineteenth century. At one stage in the early medieval period extremely heavy vehicles had crossed the area leaving ruts deeply scored into the natural brickearth (fig. 66, pl. XVI). The ruts averaged 3–5 in. (0.08–0.13 m.) wide and where obvious pairs could be observed they were 6 ft. (1.83 m.) apart. Whether wheeled vehicles or sledges were involved it is impossible to say. The ruts could be seen to cross the tops of some of the Roman and Saxon pits, as well as pits 99 and 100 which can be dated to the beginning of the twelfth century, but were cut by pit 96, which is thirteenth-century in date. They must therefore be assigned to some time within the twelfth or very early thirteenth centuries. One possible context for such heavy traffic would have been the construction of the Priory in the early twelfth century, when quantities of building material would have had to be transported to the south-east quarter of the fort. That the ruts are well aligned on a direct path between the landgate and the Priory site, respecting the line of gully 3 which probably existed as a boundary at this time, offers some support to this view.

The hollow originally created by the Roman pit 187 (immediately north-west of the north-west corner of the store building) was apparently avoided by traffic and allowed to fill slowly with soil. Here three medieval layers could be recognized, a thick lower ploughsoil divided by a turf line from a thin upper ploughsoil (fig. 127; section 16, trench 99, layers 56, 49, 45). The sequence resembles that observed in area A, where two phases of agricultural activity were separated by a phase of occupation. Beyond the north end of the store building, however, the surface had been disturbed in the early sixteenth century and a spread of flint and gravel metalling had been laid to consolidate the ground in front of the entrance to the building (fig. 127; section 16, trench 109, layer 12).

As in areas A and B, the construction levels of the storehouse built in the early sixteenth century preserved a turf line which had formed throughout the preceding century. It seems probable that the early version of gullies 9 and 32 had substantially silted up by this time and that the turf line had formed over the fill. Late in the fifteenth or early in the sixteenth centuries the ends of gullies 9 and 32 were re-dug to their final profiles. This was followed by a brief period during which silt accumulated in them, before they were deliberately filled immediately prior to the construction of the store building. In both trench 98 and 99 mortar and rubble make-up was spread within the store building in an attempt to raise the ground surface for the floor, but no flooring material survived in position.

Apart from gullies and pits, described in their appropriate sections, the only other medieval features recovered were postholes. Since it is nowhere possible in area C to relate postholes to their contemporary ground surfaces, the only method available to date them is by reference to the latest material found within them, always bearing in mind the obvious shortcomings of such a procedure. It is upon this basis that the postholes shown in solid line on fig. 66 have been selected. Since, however, there is reason to believe that very few of the holes are likely to be Roman (Vol. I, *passim*) and the area seems to have been used largely for pit digging

in the late Saxon period (Vol. II, fig. 100), the likelihood is that most of the postholes north of the line of gully 9 are medieval. This view is to some extent borne out by the relatively high percentage which have produced medieval pottery compared with very few of the total in areas A and B. For this reason all postholes containing Roman or Saxon pottery (which are not characteristic of the eighteenth- and nineteenth-century posts) have been shown on fig. 66 in broken line. A consideration of the postholes in terms of depth-diameter ratios, shape, etc., has failed to suggest significant groupings except that most of the elongated holes produce medieval pottery.

Any interpretation of the medieval and medieval (?) posts is fraught with difficulty, but two, possibly three, north-south rows stand out clearly. These may possibly represent buildings or fenced plots running at right angles to the main east-west road. If so, the overall appearance is not unlike the croft and toft arrangement, with houses fronting the road and cultivation plots behind to the south of gully 9 and gully 32. Such an arrangement might be thought out of place in a castle unless of course members of the castle's retinue were housed here in the outer bailey. An alternative view, that the posts represented corrals for animals, is also possible. All this, however, is largely speculative and is forced to remain so by the nature of the evidence.

Description of Features and Postholes (fig. 66)

Posthole	Diam. (in.)	Depth (in.)
1	20	13
5	17 × 20	4
9a	14	6
9b	20	5
11	17 × 28	12
14	10	17
19	18 × 32	11
21	24	14
25	23 × 26	9
27	22	15
31	8	4
49	12 × 24	5
50	19	11
88	6	5
91	33-50	10
97b	24	10
114a	16	9
114b	19	6
114c	16	9
240	16 × 22	10
242	10 × 12	5
255	34 × 42	14
945	9 × 15	2
946	20	7
1003	21	10

THE BUILDINGS

Apart from the possibility of timber buildings fronting the east-west road mentioned above (p. 36) and not further discussed, three buildings were discovered within the excavated area. Buildings M₂ and M₃ were built in timber in the fourteenth century, while the third structure, a storehouse of Tudor date, was of masonry construction.

Building M₂
(fig. 15)

Building M₂ was a rectangular structure 26 ft. (7.9 m.) wide and in excess of 32 ft. (9.8 m.) in length. Its west wall, represented by a shallow footing of flints set in a crumbly white mortar, measured a little over 2 ft. (0.6 m.) wide and 9 in. (0.23 m.) thick. The footing presumably served as a sill upon which the timber superstructure of the gable end had rested. The fact that the side walls were not so founded, and that the southern end of the masonry sill partly covered the disused posthole (posthole 650), which may have served as a corner post for the original phase of the building, allows the possibility that the masonry sill may have been the result of a later underpinning of the gable end wall. This point, however, cannot be demonstrated with certainty.

The south wall of the building appears to have been based on a horizontal timber ground sill 1 ft. 3 in. (0.38 m.) wide, the impression of which, no more than 1½ in. (0.04 m.) deep, could be traced for part of the length. On the line of this beam, at the eastern limit of the excavation, a series of loose packed limestone slabs were found, constituting either a door sill or underpinning for a replacement wall beam. (It could not have underpinned the original beam because the top of the slabs was 6 in. (0.15 m.) higher than the bottom of the beam slot to the west.) The position of the north wall was more difficult to trace, but part of its edge was clearly given by the northern limit of the adjacent clay floor. Three postholes lay approximately along this line, postholes 1201, 901, 902. Two of them, 901 and 902, cut through the floor surface and through the line of the beam, and therefore must be considered to be later, perhaps representing a rebuilding of this part of the structure using vertical timbers instead of a timber-framed construction based on a ground sill. Whether or not posthole 1201 belonged to the rebuilding, or was an integral part of the original structure, matching posthole 650, remains uncertain.

The features within the walls of the house pose problems of interpretation. They consist of two rows of postholes or slots, one parallel to the north wall and one parallel to the south, both about 3 ft. (0.91 m.) from the respective walls. In both rows there is clear evidence of at least two phases. Two feasible explanations present themselves: either the posts and slots are to be regarded as the walls of a separate earlier or later medieval building of smaller size, or they represent the aisle timbers of the larger building. One observation may be thought to support the view that the two buildings were of different dates: the inner posts seem to be too close to the walls to create aisles of acceptable width. Moreover, aisled buildings of fourteenth-century date, while they do exist, are unusual. On balance, then, it would be safer to assume that two separate buildings existed on the site, one replacing the other. If

this were so, the three blocks of greensand to the north of posthole 649 could be interpreted as part of the structure of the gable wall of the smaller building.

The floor levels of the building were difficult to recognize overall, but an area of trampled earth with patches of clay and charcoal trodden into it survived immediately to the south of gully 11a, and must represent the floor of the smaller building. It lay 11 in. (0.28 m.) below

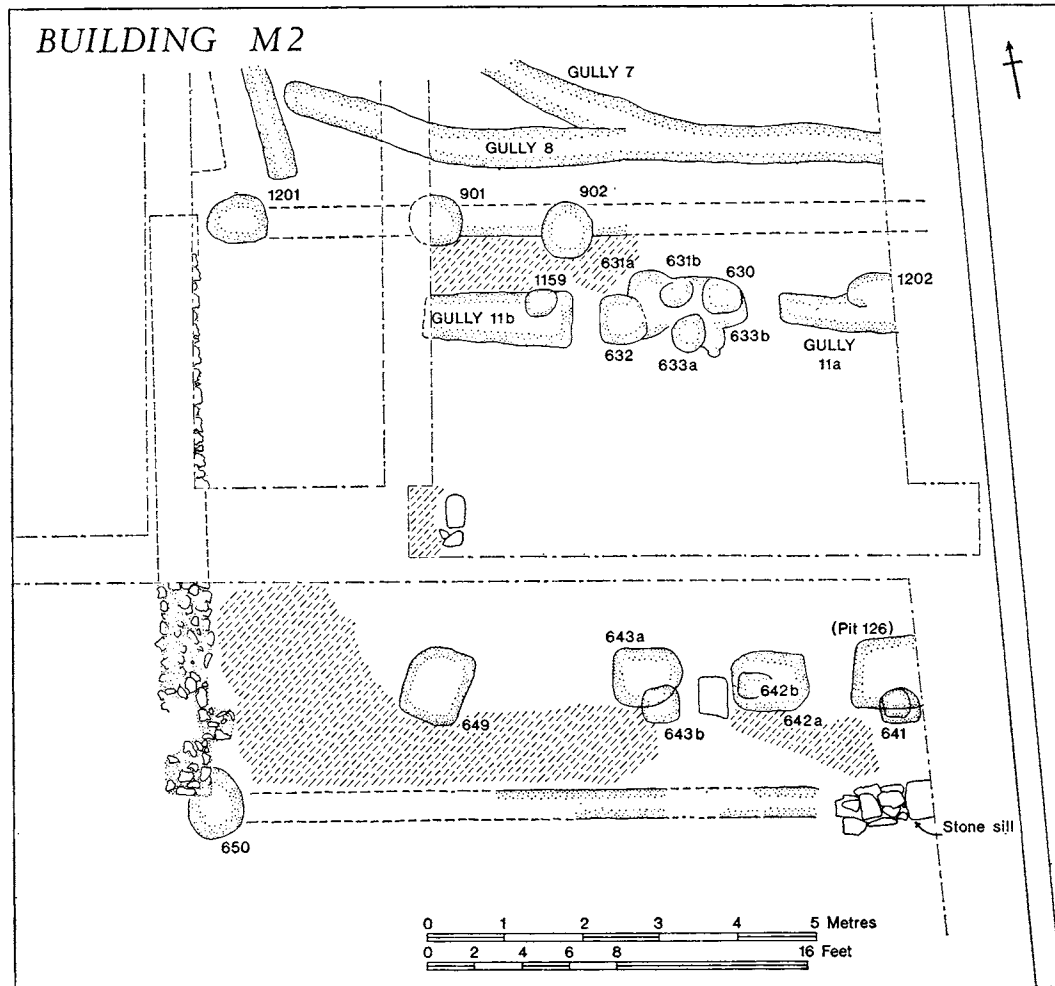

FIG. 15

the surviving floor of the larger building, which could be traced as a stony layer to the north of gully 11a and a spread of clay to the north of gully 11b. That no trace of this upper floor survived to the south of the north wall of the smaller building strongly suggests that it had been removed at the time when the smaller building was constructed, though why the floor of the smaller building was sunken at this point remains obscure.

In the south-west corner of the larger building traces of floor level survived in the form of a trampled but discontinuous spread of redeposited brickearth up to 3 in. (0.08 m.) thick. The floor ended on the line of the wall beam, and did not extend over or beyond the line of posts representing the south wall of the smaller building. Thus the evidence here could also be taken to indicate that the smaller building was the later.

Although the area within the building seems to have been kept free of rubbish the soil accumulation outside contained considerable quantities of pottery, implying a domestic use for the building in one or both of its phases. No roofing material survived in relation to either structure.

Dating

The pottery discovered in associated occupation levels has been listed and described below (pp. 167–70). It belongs to the general category which has been styled here the *late medieval tradition* (pp. 134–5), dating approximately to the fourteenth century. Further precision is at present impossible.

Structural and Stratigraphical Details

Posthole	Diam. (in.)	Depth (in.) below natural	Relationship, etc.
650	27 × 36	8	Filled before wall footing
649	33 × 38	8	
643a	30 × 36	2	643b possibly earlier than 643a
643b	18 × 18	9	
642a	30 × 36	8	642b truncated by 642a
642b	12 × 18	9	
(Pit 126)	36 ×	18	Pit 126 cut by posthole 641
641	18 × 19	21	
1201	24 × 30	7	
901	27	9	
902	27	7	
1159	12	12	Cut gully 11b
631a	18	8	All relationships not apparent, but 632 later than 631a; 630 and 633a later than 633b
631b	12	10	
630	18 × 16	12	
632	24	7	
633a	18	7	
633b	12	8	
1202	15 ×	12	Cut gully 11a
Gully 11a	—	5	
Gully 11b	—	3–6	

The depths for the features are given below the surface of the natural brickearth. This is on average 12–18 in. (0.30–0.46 m.) below the contemporary ground surface. The features were without exception filled with grey soil containing small stones and occupation debris.

Contemporary occupation levels	trench 45, layer 2 trench 47, layers 3, 4 and 5 trench 57, layers 3, 13 and 14 trench 85, layer 4 trench 87, layers 2 and 3 trench 88, layers 3 and 7
Clay floor in south-west corner of large building	trench 87, layer 4
Clay floor in smaller building	trench 85, layer 5

Building M3
(fig. 16)

Traces of a rectangular building measuring approximately 30 by 20 ft. (9.1 × 6.1 m.) were found built against the south wall of the fort immediately to the west of the medieval south postern gate. The building had been terraced into the stub of that part of the Roman wall which survived in front of the vertical face created in the early medieval period (p. 7). The terracing had removed up to 2 ft. (0.6 m.) of Roman masonry, leaving the original eroded core still exposed to the west of the west wall of the building (pl. IIb). As part of the

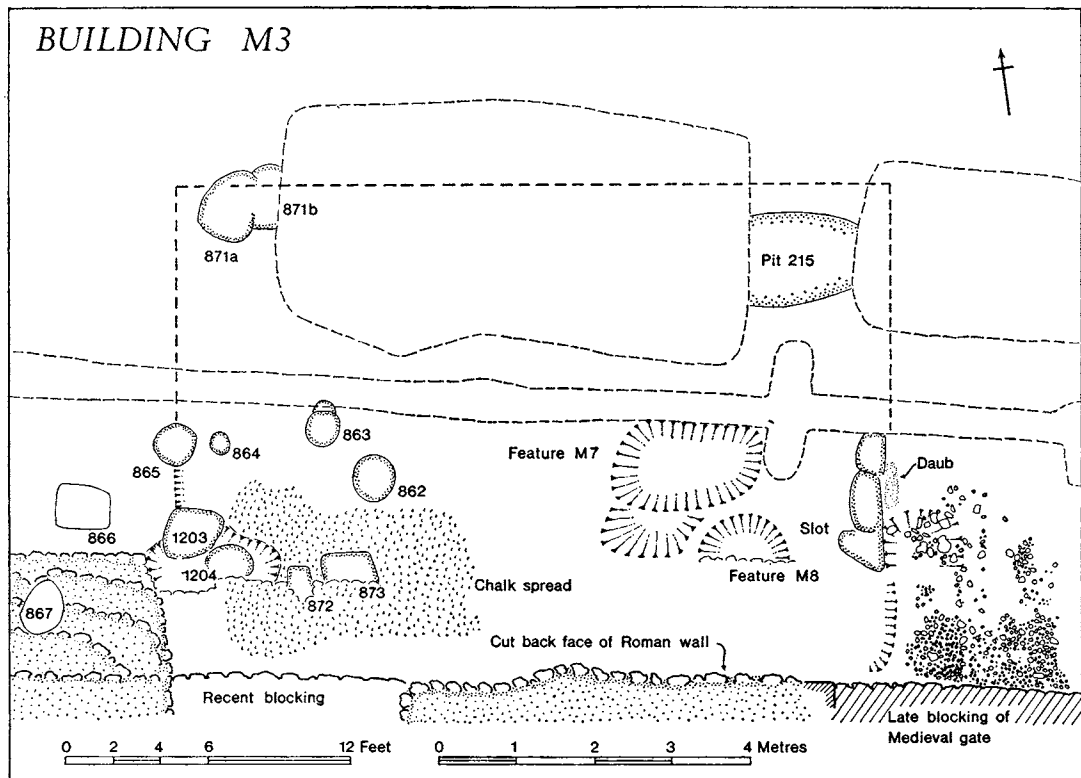

FIG. 16

preparation work it would appear that the builders had hacked an opening through the Roman wall into the hollow bastion beyond, thus creating an additional room. The gap was blocked in the 1930s.

Little survived of the northern part of the building, due to the destructive effect of two early nineteenth-century pits and a construction trench for a fence of that date, but the southern part of the building was reasonably well preserved. The side walls of the building were constructed on a basis of vertical timbers placed in individual postholes, in-filled between with wattle and daub. A fragment of fallen daub 4 in. (0.10 m.) thick was found close to the east wall, while smaller fragments, some slightly baked, were found in the rubble filling the building close to the west wall. Since no fragment of wattle and daub wall was found in position, nor were wattle marks traced in the underlying soil, it is impossible to say whether or not short timber ground sills were employed between the verticals.

Within the building, a thin trampled chalk floor survived in the south-west corner. Several pits, hollows and postholes, broadly contemporary with the use of the building, were discovered and are described below.

There is little that can be said of the superstructure of the building, but presumably it was a lean-to making use of the fort wall. The absence of tile or slate in the building rubble would suggest that the roof was probably of shingles or thatch. Several inches of occupation debris accumulated within and immediately outside the building before it was finally abandoned and the hollow created by its terrace became filled with flints and mortar derived from the erosion of the fort wall.

It will be apparent from the plan (fig. 16) that the east wall of the building encroached by as much as 2 ft. 6 in. (0.76 m.) upon the road which served the postern gate. Since the terrace of the building was cut down through the road surface, the building must be later. While this does not necessarily prove that the gate had gone out of use and had been blocked by the time that the building was constructed, the logic of the sequence would imply that this was so.

Dating

The dating of the building depends upon the associated pottery which is described below (p. 171). It can be assigned to the *late medieval tradition* and dated to within the fourteenth century.

Structural and Stratigraphical Details

- | | |
|------------|---|
| Pit 215 | See pp. 93-4. |
| Feature M7 | Cut to maximum depth of 1 ft. 4 in. (0.41 m.). Filled with light brown mortary soil containing fragments of daub.
Trench 107, layer 28. |
| Feature M8 | Cut against the face of the Roman wall to a maximum depth of 1 ft. (0.30 m.). Filled with light brown mortary soil containing fragments of daub.
Trench 107, layer 26. |
| Slot | Three shallow hollows cut to a depth of 4 in. (0.10 m.) containing eroded daub mixed with soil.
Trench 107, layer 29. |

Postholes	Diam. (in.)	Depth (in. below contemporary surface)
862	20	14
863	17	10
864	10	10
865	22	14
866	25 × 23	24
867	27 × 23	7
871a	36 × 27	13
871b	30	15
872	12	15
873	26 × 12	17
1203	24 × 35	16
1204	24 × 15	12

} relationship undefined

Floor levels	trench 107, layers 22 and 29 trench 108, layer 316
Occupation levels	trench 107, layers 21 and 23 trench 108, layers 24, 31, 33 and 75
Rubble above	trench 107, layer 4 trench 108, layer 20

*The Tudor Storehouse*¹
(fig. 17, pls. XVII, XVIII)

The storehouse has long been recognized as a recurring parch mark in the otherwise lush grass growing in the south-west corner of the Roman fort.² It was photographed from the air by Major Allen (pl. XVIIa), and described on this basis by O. G. S. Crawford (Crawford, 1938). Such was the sharpness of the parching that the outline of the building could be precisely measured, and thus came to be added with a tolerable accuracy to the plans produced by the (then) Office of Works.

During the area excavation of 1964-72 the site of the storehouse was entirely cleared (pl. XVIIIa, b). The surviving remains consisted of massively built foundations 4-4½ ft. (1.22-1.37 m.) wide, constructed in foundation trenches which had been cut through the overlying soil accumulation and into the natural brickearth. At the north end of the site they were as little as 3 ft. (1 m.) deep, but increased to 6 ft. (2 m.) at the south end, where the early rubbish accumulations were thicker. Many types of stone were used, much of it deriving from the old buildings of the castle, but a considerable proportion consisted of waterworn boulders of Bembridge limestone and other stones presumably brought in for the purpose by boat from the Isle of Wight. At intervals of 20 ft. (6 m.) or so the foundations were buttressed on their outsides, except at the north end where recently filled ditches caused the

¹ This section is an extended version of an interim description already published (Cunliffe, 1971). I would like to thank Mr David Baker for his help with the documentary references and Mr A. Corney of the Portsmouth City Museum

for putting the results of his researches into the Portsmouth storehouse at my disposal.

² The first reference appears to be in *VCH Hants*.

PORTCHESTER CASTLE

16th CENTURY

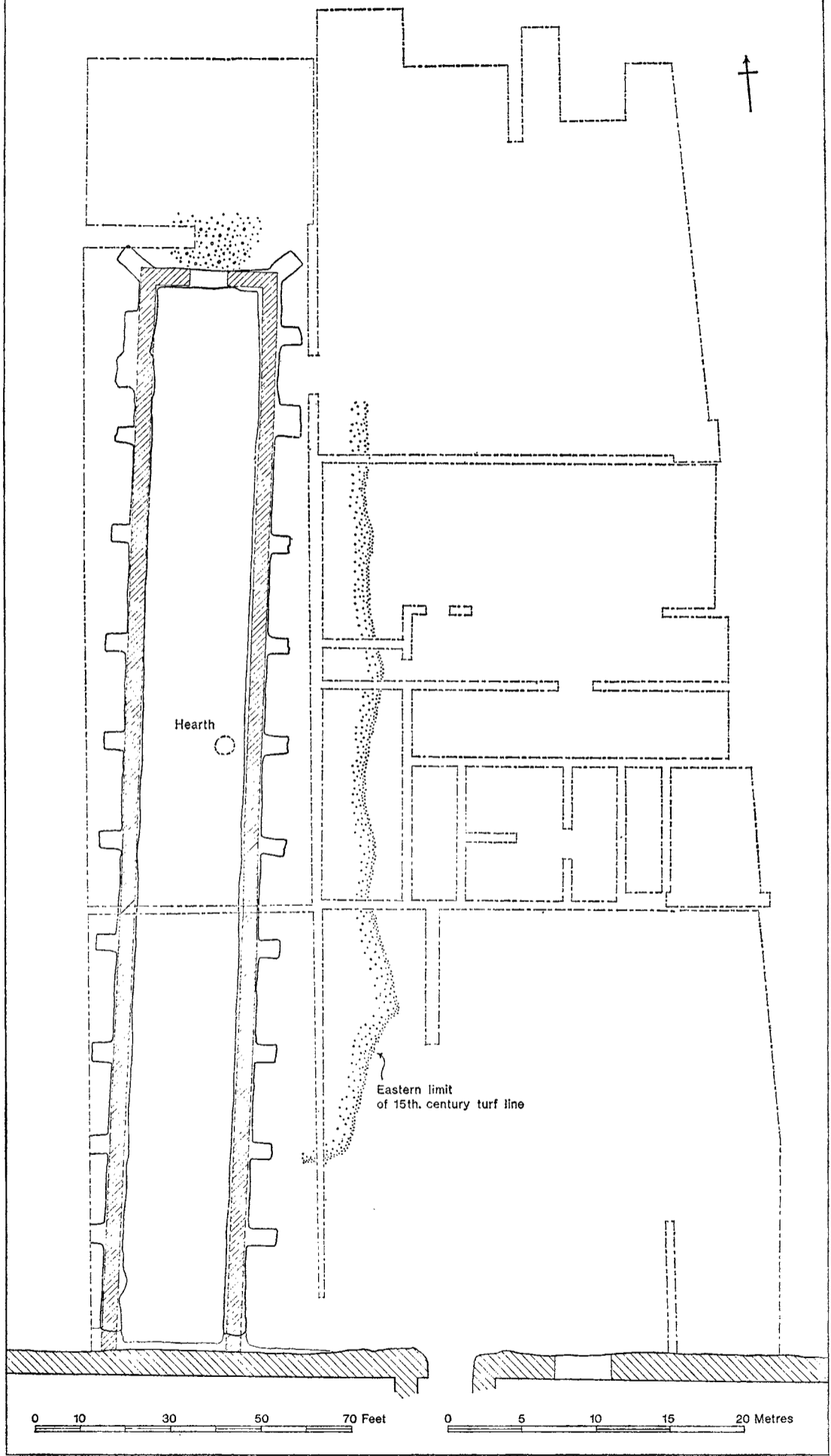

FIG. 17. The Tudor storehouse

builders to vary the procedure in order to counter the problems of potential subsidence (pl. XXIII*b*): diagonal corner buttresses were provided on the northern corners (pl. XVIII*b*).

The spoil from the foundation trenches was spread out within and on either side of the building, sealing the pre-building turf line and raising the level by about 9 in. (0.23 m.).

The surface of the foundations had been carefully levelled to support walls $3\frac{1}{2}$ ft. (1.07 m.) wide. That the walls had indeed been constructed was shown by the mortar seating for the basal course, but not one block of the free standing superstructure survived. It could, however, be demonstrated beyond doubt that this superstructure, unlike the footings, was *not* buttressed, since fillets of mortar representing the front faces of the walls in many cases continued irrespective of adjacent buttressed footings (pl. XVII*b*). Two explanations are possible: either it was intended that the building should be buttressed but plans were changed during construction after the foundations had been completed, or, more likely, the buttresses were designed to give strength only to the foundations. Such a strengthening would have been a considerable advantage in providing stability in the heavily disturbed subsoil hereabouts.

The above-ground form of the building is uncertain, but the walls may well have been unrendered rubble work with a roof of shingles, straw thatch or broom. The positions of the windows are unknown, but the principal doorway, $9\frac{1}{2}$ ft. (2.90 m.) wide, lay in the centre of the north end, conveniently sited for easy access to the main east-west road. There may also have been subsidiary doors in the side walls. No trace of flooring survived, but the make-up between the walls was in places sealed with a thin spread of mortar which had survived the subsequent disturbances of the eighteenth and nineteenth centuries. The mortar did not in itself appear to have served as a surface, but may have been the bedding for a stone-flagged floor of which only a few loose broken fragments were found in the rubble representing the demolition phase.

The only internal feature to survive in association with the building was a small hearth for melting lead. It measured 4 ft. (1.22 m.) in diameter and was built of bricks and slabs of Portland limestone set in clay in a hollow cut into the pre-building turf line. The hearth had been subjected to intense heat which had caused some of the lead contained within it to melt and trickle down through cracks in the lining. The hearth belonged either to the construction phase of the storehouse or to the years immediately preceding it, since it was cut through the same turf line as the footings, but was sealed by the make-up layers below the floor of the building. It may have been used to melt lead to make fittings for use in the new structure. The demolition of the building was thorough: the walls were pulled down and all the stonework removed, together with the floor slabs, leaving only a thin spread of broken-up mortar and stone chippings.

Dating

The apparent buttressed form of the building suggested, quite reasonably, to Crawford and subsequent writers (Crawford, 1938; Rigold, 1965) that the building was of medieval date. Excavation, however, eventually showed that this was not so. In archaeological terms the date of the building rests upon the rubbish which was thrown into gully 9 when it and gully 32 were filled and levelled immediately prior to the digging of the foundation trenches.

This material has been discussed in some detail below (pp. 180–3, 194–6, 210–11) where it is shown that finds and pottery all date to within the bracket 1475–1540. Thus, on this evidence alone it is reasonable to suggest that the building was probably erected in the first half of the sixteenth century. Demolition is more difficult to date precisely, but sufficient time had elapsed for a stone-free topsoil to have begun to develop over the footings in places before the deposition of occupation and building levels containing mid to late eighteenth-century material. A demolition date before the middle of the seventeenth century therefore seems to be indicated on archaeological grounds.

The documentary record of the castle includes references to a building which is almost certain to equate with the excavated structure, and thus offers more precision in dating. Sir John Daunces' accounts of money received from the treasurer of the King's chamber refer to a sum of £400 paid between 1521 and 1527 'to my Lord Lisle, upon the buldyng of a stores house at the castell of Porchestre, and other causes',¹ while in 1585 we learn of the 'repairing of a long store house at Portsmouth, that came from Portchester'.² This last reference presumably implies that the storehouse at Portchester was no longer in use and may have even been demolished and the materials transported to Portsmouth. Certainly, by the time of the Norden survey in 1609 there is no mention of the building, which, had it been standing, would surely have been described. If Lord Lisle's storehouse can be equated with the excavated building, which seems reasonable since it fits the chronological context provided by the archaeological evidence, then its construction provides a valuable *terminus ante quem* for the group of pottery and finds sealed in gully 9.

By an interesting coincidence an early sixteenth-century storehouse of almost identical proportions, 30 by 234 ft. (9.14 × 71.32 m.) compared with 31 by 237 ft. (9.45 × 72.23 m.) at Portchester, has been recently recognized at Portsmouth during its demolition to make way for an extension to the power station. The Portsmouth storehouse was built of rough stone faced only on the external face, and was originally thatched with broom. Its main door lay in the short end. The structure was referred to on several occasions in contemporary documents and is shown in the Cowdray print,³ complete with barrels being taken from it and loaded at the town quay nearby. The storehouse was under construction in 1514, when the captain of the Portsmouth garrison, Richard Palschyd, was allowed a sum of money 'for building a great storehouse at Portsmouth'.⁴ On 17th June 1557 'ther did happen a Great and Terryble flyer begonne within a Storehouse of the Kynge and Queenes Majesties in Portsmouth, aforesaid called the Broomhouse . . .'.⁵ The stone shell of the building survived and was subsequently renovated. In 1782 it was encased in brickwork and remained thus until it was exposed by bombs in 1940–1 and subsequently demolished in 1963.

The structural details and size of the Portsmouth and Portchester storehouses are strikingly alike, but since both buildings were in use at the same time the references to the removal of the storehouse from Portchester to Portsmouth must imply function rather than structure. The close similarities, however, argue for a degree of standardization in the naval architecture of the sixteenth century.

¹ Quoted in *VCH Hants* iii, 157.

² *Cal. S.P. Dom.* 1581–90, p. 257.

³ Produced in 1778 by James Basire for the Society of Antiquaries after a contemporary wall painting formerly

in Cowdray House, near Midhurst, and subsequently destroyed in a fire.

⁴ *Letters and Papers, Hen. VIII*, vol. 1, p. 960, no. 5724.

⁵ Brit. Mus. Add. MS. 5752, fol. 51.

GULLIES

(figs. 18–21)

Most of the gullies of medieval date belong to three systems which were constructed to drain the environs of buildings or to serve as boundaries. In the following descriptive section they will be considered in four groups:

Group A: gullies 1, 2, 19, 20 and 21, and soakaway pit 78.

Group B: gullies 4, 6, 7 and 8.

Group C: gullies 3, 5, 9, 16, 30, 31 and 32.

Miscellaneous: gullies 11, 17, 18, 28, 29, 33, 35 and 37.

Group A

This complex appears to have been constructed to serve as drains emptying into the soakaway pits referred to here as gully 20 and pit 78. Gullies 1 and 2 (pls. XXI*b*, XXII) drained the area to the east, running from the vicinity of building M2, while gullies 19 and 21 drained from the west. The system was several times partially re-cut.

In the first stage, gully 1 (fig. 18; section 6, layer 7; section 5, layer 9; section 3, layer 10; sections 2 and 4, layer 52) opened into a hollow represented by an early version of gully 20 (section 1, layer 26), which appears to have been subsequently re-cut (section 1, layer 69). The precise relationship of gullies 19 and 21 to this early system could not be demonstrated with certainty, but it is possible that gully 21 preceded gully 19 and was contemporary with the first phase of gully 20 (i.e. section 1, layer 26), while gully 19 was cut at the same time as the second stage of gully 20 (i.e. section 1, layer 69). It was probably in this second stage that the western part of gully 1 was deepened (section 3, layer 27). The third stage is represented by the deepening of gully 20 to its final profile. Finally, in stage four, the deep soakaway pit 78 was dug to a depth of 5 ft. (1.5 m.) below the contemporary ground surface (pl. XXII*a*). It may have been at this time that gully 2 was cut to replace the east end of gully 1 (section 6, layer 15; section 5, layer 10).

The lowest filling of pit 78 (layers 47–9) accumulated rapidly. It consisted of grey silty soil, some large flints, lenses of charcoal and burnt clay, thick tips of winkle shells, together with lenses of brickearth which had eroded in from the sides (section 4). After this initial rapid filling, silting proceeded more slowly, giving rise to layers of grey silty soil, some occupation material, and accumulations of loose flints (sections 2 and 4, layers 42–6). If the third stage of gully 20 had not already silted before the digging of pit 78, then its filling (section 1, layers 36) may be considered to be contemporary with the upper filling of pit 78. The exact sequence is, however, impossible to demonstrate.

The fillings of the rest of the gullies require little comment. With the exception of the re-cut section of gully 1 they were filled with grey stony silt derived from the erosion of the soil on either side. The re-cut length of gully 1, which was probably kept open until the system was abandoned, was filled with loosely packed flints apparently at the same time as flints were tipped in to fill the upper hollow of pit 78. This may represent a deliberate act of levelling, after which soil accumulated in the remaining hollows.

EXCAVATIONS AT PORTCHESTER CASTLE

GULLIES 1 & 2

Section 1

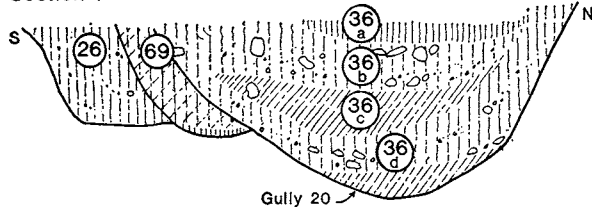

Section 2

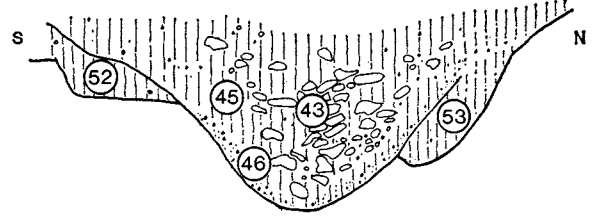

Section 3

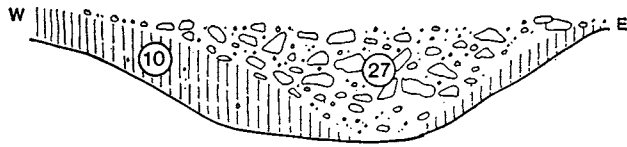

Section 4

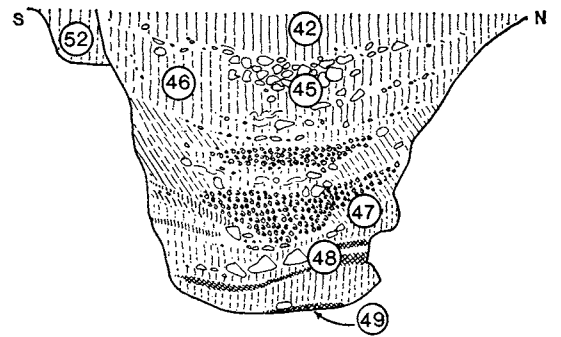

Section 5

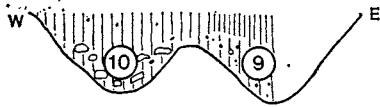

Section 6

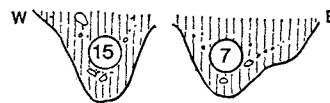

GULLY 3

Section 7



Section 8



Section 9

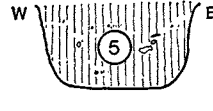

Section 10

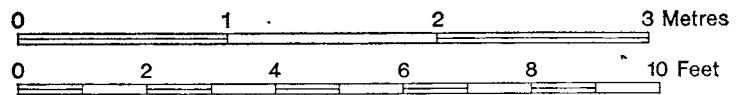
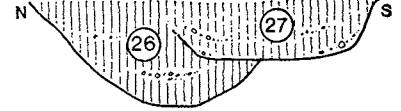

FIG. 18. Sections of gullies (for positions, see figs. 64-6)

Gullies 1 and 2 post-date gully 3 and cut through pit 44. Gullies 19 and 21 post-date gullies 16 and 29 but were cut by the foundations of the early sixteenth-century store building.

Dating

Pottery recovered from the gully system is illustrated and described below (pp. 158–9, 163, nos. 167–78 and 207–13). It belongs generally to the *late medieval tradition*, for which a fourteenth-century date is suggested. The quantity is too small to allow a sequence to be built up representing the different phases of the re-cutting.

Small Finds

Gully 19 Bronze disc (1816): not illustrated
 Gully 20 Bronze fragment (1809): not illustrated
 Gully 21 Roman bronze coin (1807): not illustrated

Group B

Gullies 6, 7 and 8 ran approximately parallel to the north side of building M2, for which each in turn probably served as a drain. The profiles of the gullies, their fillings and their relationships to each other are best appreciated by reference to fig. 19, sections 13 and 14.

Gully 8, dug close to the wall of the building, was the first. Since it deepened slightly to the east it cannot have drained into the end of gully 1, although it might have overflowed in this direction. It was partially replaced by gully 7 which diverged from the original line and widened out before emptying into the end of gully 1. This widening (section 14) was probably the result of re-cutting. At a still later stage gully 6 was dug, clear of the earlier lines. It cut through the silted up end of gully 1 but emptied into gully 4.

Gully 4 was in fact a trench 4 ft. (1.22 m.) wide, 3 ft. (0.91 m.) long and cut to a depth of 1 ft. 6 in. (0.46 m.) below the surface of the natural brickearth and packed with large flints mixed with soil. The absence of erosion or silting implies that the filling was immediate and deliberate. Presumably the intention was to create a soakaway trench which in all probability superseded the drainage system represented by the gullies of group A described above.

In addition to the relationships between gullies 6, 7, 8 and gully 1 already described, gully 4 could be shown to post-date gully 3. It could also be shown to have been dug from a ground surface higher than that from which gully 2 was dug, thus supporting the view that it was later than the gullies of group A.

Dating

The pottery from these gullies is not plentiful, but the more distinctive sherds are described and illustrated below (figs. 38–9, nos. 181–92), where it is suggested that the group belongs to the *late medieval tradition* and should be dated to the fourteenth century.

Small Finds

Gully 6 Roman bronze coin (904): not illustrated
 Roman bronze coin (906): not illustrated
 Gully 4 Casket key ? Roman (119): fig. 110, no. 79
 Loop, possibly a brooch or buckle (120): fig. 110, no. 81

EXCAVATIONS AT PORTCHESTER CASTLE

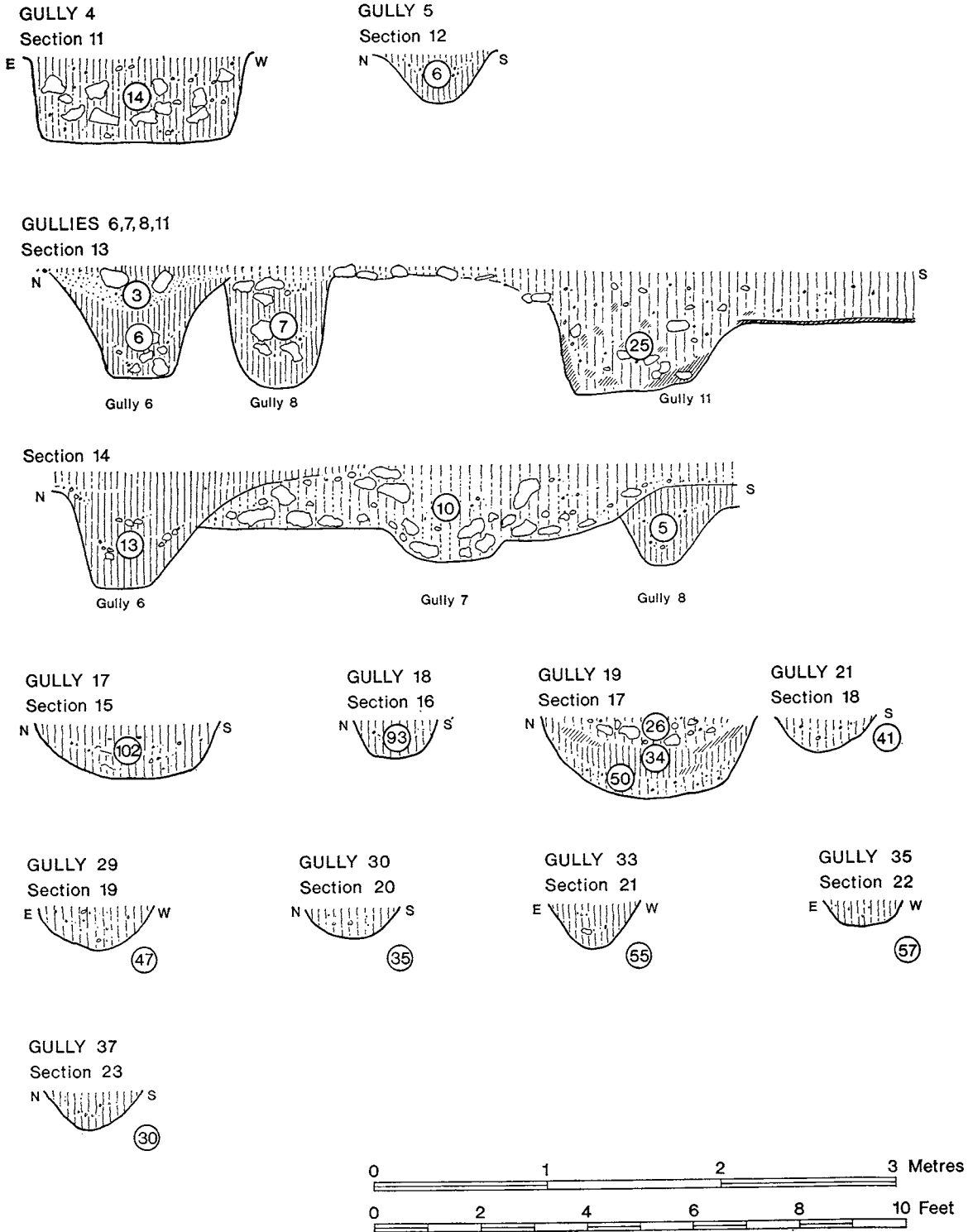

FIG. 19. Sections of gullies (for positions, see figs. 64-6)

Group C

Unlike the gullies of groups A and B, which were dug primarily as drains, the gullies of group C appear to have served as land divisions or boundaries. Although individual lengths were re-cut on several occasions, thus destroying evidence for the original layout, the intention seems to have been to create an east–west boundary, running parallel to the main road, with north–south ditches dividing the land to the south of it into plots. The one plot wholly excavated averaged 70 ft. (21.3 m.) wide.

Gullies 3 and 5

Gully 3 delimited the corner of one plot of land, subdivided by gully 5. The southern limit of gully 3 could not be defined since its projected course was occupied by the later gully 4 and the west wall of building M2. Beyond this, had the gully continued south towards the fort wall, the extensive disturbance in this area might have destroyed all trace of it.

The line of gully 3 projected to the east is, even today, marked by a noticeable scarp, which can be traced across the church yard, dividing a low lying area to the south, around the church, from a greater depth of soil accumulation to the north. It is tempting to suppose that this line marked the position of the Priory boundary, but without excavation the contention must remain speculative. The form of gullies 3 and 5 is best appreciated by reference to the sections (fig. 18, sections 7–10; fig. 19, section 12). Overall they were filled with an accumulation of grey stony soil: only the east–west arm of gully 3 showed any sign of re-cutting.

Dating is confined to a few sherds from the upper level of gully 3 (fig. 88, nos. 179–80) for which a generalized date in the thirteenth or early fourteenth centuries is suggested. Gully 3 cut the early twelfth-century pit 44, but was in turn cut by gullies 1 and 2, a relationship which tends to support a date in the later twelfth and thirteenth centuries.

Small Finds

Gully 5 Bronze pin of Roman fibula (732): not illustrated
 Roman bronze coin (742): not illustrated

Gully 16

Gully 16 ran north–south between gully 9 and the wall of the Roman fort. For much of its length it had been wholly or partially destroyed by the foundation of the sixteenth-century storehouse.

In its original state the gully was divided into two lengths by a gap 10 ft. (3.05 m.) wide. The northern sector was flat-bottomed, 6–7 ft. (1.8–2.1 m.) wide and 2–3 ft. (0.6–0.9 m.) deep, while the southern length was somewhat deeper (fig. 21). At a later date the partially silted ditches were re-cut, the causeway between them being abandoned. The re-cut ditch was V-shaped, narrower and deeper than the original ditches, but the re-cutting need not have followed the entire length, since it could not be traced further north than section 32 (fig. 21) where its filling was only barely distinguishable as a more stone-laden soil. It could however be clearly seen cutting through the partially silted original ditch in section 33 where traces of an earlier re-cut were also indicated. South of the original gap, the re-cut

EXCAVATIONS AT PORTCHESTER CASTLE

GULLY 9
Section 25

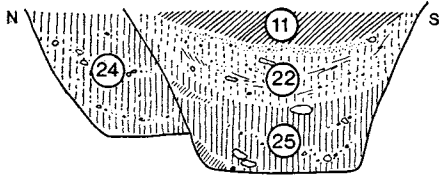

Section 26

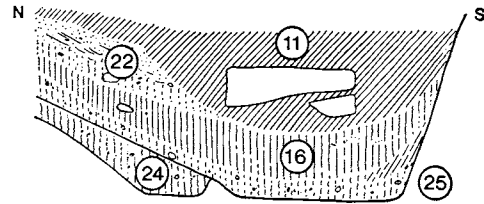

Section 27

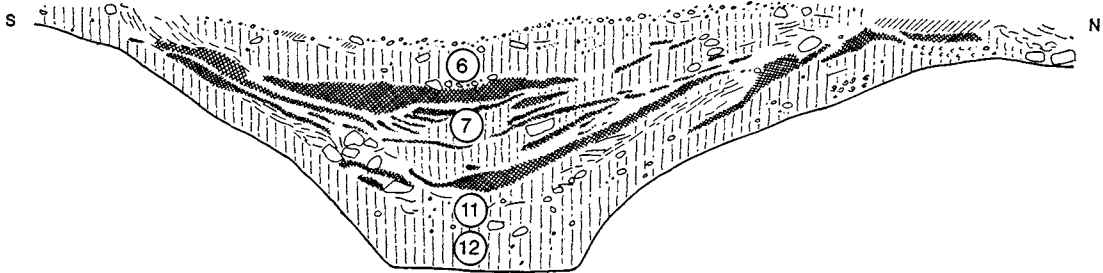

Section 28

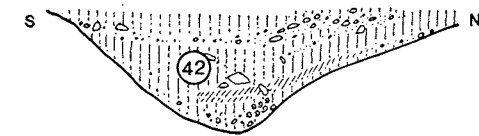

Section 29

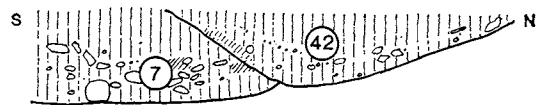

GULLY 32
Section 30

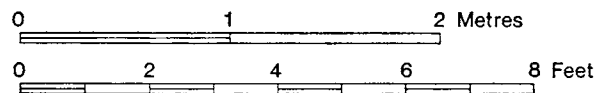
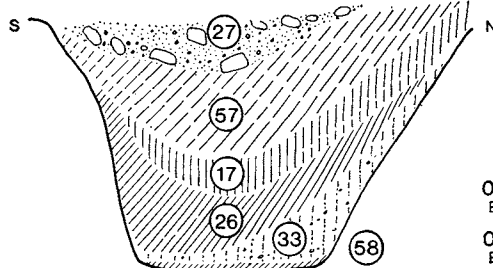

FIG. 20. Sections of gullies (for positions, see figs. 64-6)

was wide and V-shaped. In part (e.g. section 34) it totally removed the earlier ditch, but further south the profile and part of the silting of the original ditch could still be seen (section 35). At this point, in the vicinity of the limekiln, the later ditch had been filled with tips of clay (see p. 31).

Dating

Gully 16 could be shown to be earlier than gullies 19 and 20 dated to the fourteenth century. The relatively small quantity of pottery from its filling (fig. 89, nos. 193–200) belongs to the *developed medieval tradition*, for which a thirteenth-century date is suggested. No significant difference of date can be distinguished between the fillings of the different re-cuts.

Small Finds

Gully 16	Bronze binding	(1748):	fig. 110, no. 80
	Bronze fragments	(1588 and 1754):	not illustrated
	Iron buckle	(2102):	fig. 108, no. 52
	Iron latch hook?	(2103):	fig. 108, no. 56

Gullies 9, 30, 31 and 32

The east–west gully, though referred to here as gullies 3, 9, 30, 31 and 32, is best considered as a single boundary feature. The earliest definable element was the east–west length of gully 3. Whether or not the line was continued to the west, in the earliest phase, it is impossible to say, but the shallow gully 30 which might be thought to represent the sole remaining length of such an early feature produced sherds of fifteenth-century date and cannot therefore represent the original line unless it was totally re-cut. However, the fact that gullies 16 and 29 (both of which pre-date the last re-digging of gully 9) end as they do, tends to support the view that an early boundary of some kind continued the line of the east–west arm of gully 3. Whatever the earliest arrangement in this centre section, at a later stage gully 9 was dug to complete or strengthen this east–west line, at the same time re-cutting the east–west arm of gully 3 (fig. 18, section 10; fig. 20, section 29). It was probably at this time that gully 30 was cut or re-cut. The western termination of gully 9 was subject to two subsequent re-cuttings, best appreciated by comparing the plan (fig. 66) with sections 25–7 (fig. 20). The original end appears as a narrow flat-bottomed ditch filled with grey stony soil (layer 24). This was later re-cut as a steep-sided ditch with a wide flat bottom, within which stony silt accumulated (layer 25) resulting, in part, from the eroding back of the north side of the ditch where it had been cut through the fill of the earlier ditch. Soon afterwards a thick deposit of silty soil began to accumulate (layer 16).

The second re-cut (i.e. third phase) created a deep rectilinear pit some feet to the east of the original end (fig. 20, section 27). After the accumulation of a layer of washed-in stony soil (fig. 20, section 27, layer 12) the hollow was deliberately filled with tips of ash, soil and building rubbish consisting of slates, roof tiles, mortar, plaster, bricks and debris from leaded windows (layers 7 and 11). Rubbish of a similar kind spread into a hollow created by the partially silted end of the phase 2 ditch (fig. 20, sections 25 and 26, layer 22). This was

followed by the deposition of tips of rammed yellow clay containing large blocks of stone (sections 25 and 26, layer layer 11) immediately prior to the construction of the footing of the store building which can be dated on documentary grounds to between 1521 and 1527. The contents of gully 9 are described in various parts of this report: the pottery (figs. 99, 100, pp. 180-3); the glass (fig. 113, pp. 210-11); the building materials (pp. 121-8); the small finds are listed here below. The pottery is wholly consistent with a date in the first two decades of the sixteenth century. Thus the ultimate (third) phase of gully 9 must have been dug some time about 1480-1500. The two preceding phases should therefore lie within the fifteenth century, but no distinctive pottery of this period has been recovered from them.

Gullies 31 and 32 continued the line of gullies 9 and 30. All that remained of gully 31 was part of one side, the rest having been cut away by gully 32. Gully 32 was similar in profile to the end of gully 9 in its second and third phase (fig. 20, section 30). It had partially silted by natural erosion (layers 58 and 33) before being deliberately filled by tightly packed layers of clay and soil (layers 26, 17 and 57) as a preliminary to the construction of the store building (pl. XXIII*b*). Although no closely datable material was recovered, its sequential relationship to the storehouse implies that, like the end of ditch 9, the last re-digging had been carried out in the early years of the sixteenth century.

The simplest interpretation of these structures is that the complex of gullies 9 and 30 formed a boundary, the latest two re-cuttings of which led to the creation of two elongated pits flanking a gap of 15 ft. (4.6 m.) in width.

Small Finds

Gully 9	Trench 73, layer 12	Iron fragment	(633):	not illustrated
	Trench 75, layer 7	Roman bronze coin	(711):	not illustrated
		Glass bead	(691):	not illustrated
		Iron purse frame	(710):	fig. 106, no. 39
		Iron strip	(655):	fig. 109, no. 68
	Trench 75, layer 42	Roman bronze coins	(752, 753, 754):	not illustrated
	Trench 73, layer 7	Bronze button fragment	(477):	not illustrated
		Bronze fragment	(475):	not illustrated
		Lead cuttings	(460):	not illustrated
		Iron spear	(459):	fig. 105, no. 30
		Iron spur	(461):	fig. 104, no. 19
		Iron key	(462):	fig. 107, no. 51
		Iron key	(463):	fig. 109, no. 63
		Iron armour	(465, 474):	pl. XL, nos. 3, 4
		Miscellaneous iron fragments	(464, 480):	not illustrated
		Plaster with inscription	(466):	pl. XLIII <i>a</i>
	Trench 73, layer 11	Bronze fragment	(651):	not illustrated
		Bronze sheet fragment	(525):	not illustrated
		Roman bronze coin	(488):	not illustrated
		Lead cuttings	(650):	not illustrated
		Lead from window	(492):	not illustrated
		Window glass	(490):	pp. 128-30 and fig. 75

Trench 93, layer 11	Iron spur	(485):	fig. 104, no. 17
	Iron square-headed bolt	(486a):	fig. 105, no. 25
	Iron point	(493):	fig. 109, no. 65
	Iron spear	(486b):	fig. 105, no. 29
	Iron hook or pivot	(500):	fig. 109, no. 62
	Iron object	(515):	fig. 109, no. 71
	Iron hinge pivot	(532):	fig. 109, no. 61
	Iron armour	(495, 649):	pl. XLI, nos. 6-10
Trench 98, layer 15	Miscellaneous iron fragments	(494, 496, 516, 524, 533, 553)	not illustrated
	Chalk object	(497):	not illustrated
Trench 98, layer 16	Iron horseshoe	(1827):	fig. 106, no. 36
	Iron horseshoe	(1822):	fig. 106, no. 35
	Iron buckle	(1810):	fig. 108, no. 55
	Iron armour	(1826):	pl. XL, no. 5
Trench 98, layer 16	Bronze fragment	(1813):	not illustrated
	Iron knife blade	(1821):	not illustrated

Miscellaneous Gullies

Gully 11

Probably a constructional feature belonging to building M2 (see pp. 37-40).

Gully 17 (fig. 19, section 15)

Short length of flat-bottomed gully averaging 3 ft. (0.91 m.) wide and 1 ft. (0.30 m.) deep. Deeper towards gully 16 with which it may have been contemporary. Filled with grey stony soil. Cut by the sixteenth-century wall footing. Thirteenth- or fourteenth-century pottery.

Gully 18 (fig. 19, section 16)

Two short lengths of gully parallel to gully 17. Approximately 1 ft. 6 in. (0.46 m.) wide and 9 in. (0.23 m.) deep. Filled with grey stony soil. Cut by the sixteenth-century wall footing. Fourteenth-century pottery.

Gully 28

Length of a shallow gully 1 ft. (0.30 m.) wide and 6 in. (0.15 m.) deep. Filled with grey soil. Cut by the sixteenth-century wall footing. Contained sherds of early medieval cooking pot.

Gully 29 (fig. 19, section 19)

Gully 1 ft. 6 in. to 2 ft. (0.46-0.61 m.) wide cut to a depth of c. 9 in. (0.23 m.). Filled with grey stony soil. A narrow length of gully, which continues the line further north, may be the original, the wider gully representing a later recutting. Its relationship to gully 19 could not be defined but in all probability it was part of the same system. The pottery was of the thirteenth- or fourteenth-century.

EXCAVATIONS AT PORTCHESTER CASTLE

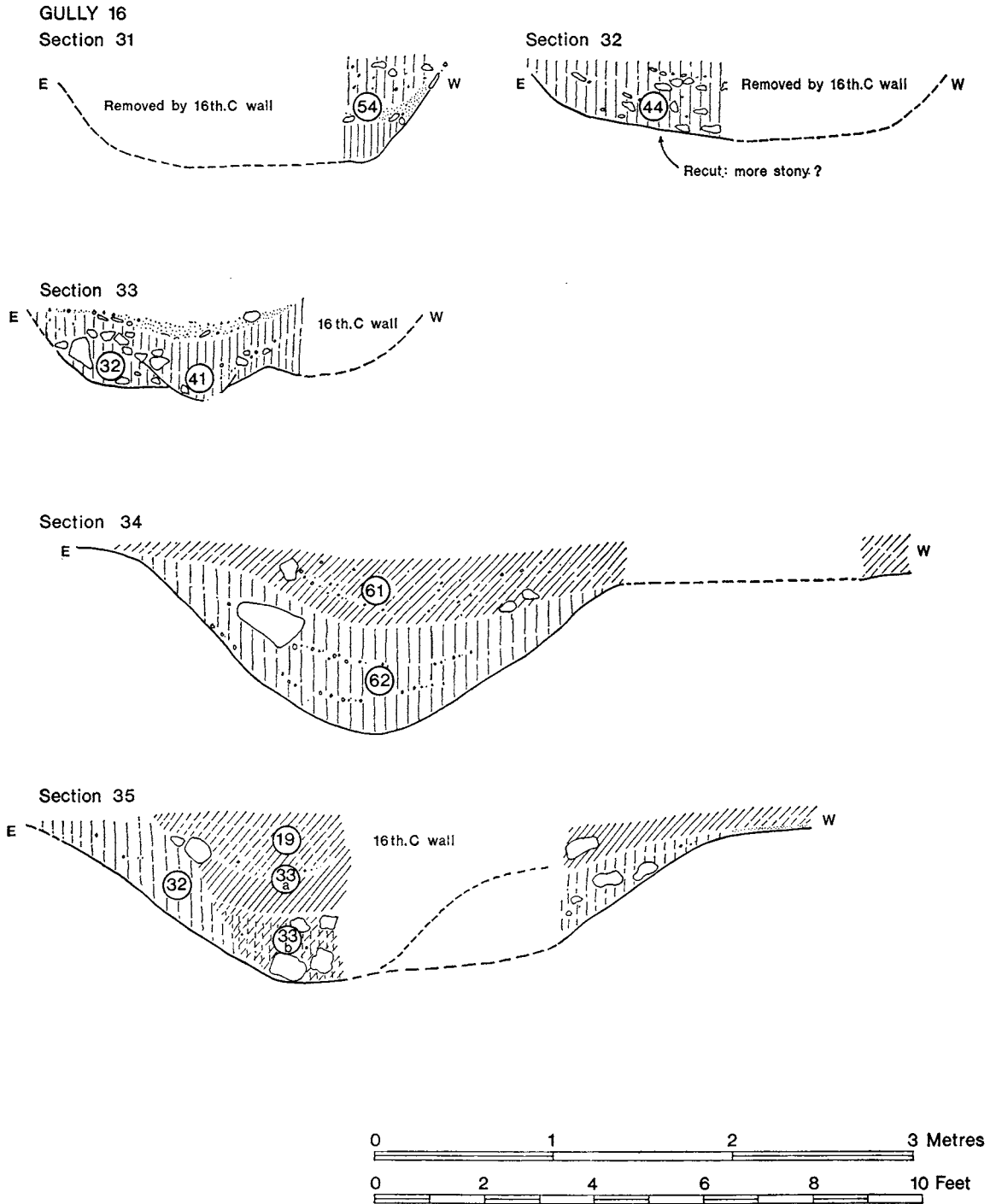

FIG. 21. Sections of gullies (for positions, see figs. 64-6)

Gully 33 (fig. 19, section 21)

Gully of V-shaped profile, up to 1 ft. (0.30 m.) deep. Filled with grey stony soil. Cut by gully 30.

Gully 35 (fig. 19, section 22)

Shallow flat-bottomed gully filled with grey stony soil. Cut by the foundation of the sixteenth-century building.

Gully 37 (fig. 19, section 23)

Gully of V-shaped profile up to 1 ft. 6 in. (0.45 m.) wide. Filled with grey stony soil. The gully was sealed by a thin discontinuous spread of chalky mortar which was in turn cut by gully 16 in its latest form. The fact that gully 37 did not continue beyond the line of gully 16 might suggest that it was contemporary with the original phase of gully 16, but the point is beyond proof.

Gully 38 (fig. 127, section 15, layer 40)

Gully, 2 ft. (0.61 m.) wide, which could be traced cutting through the collapsed rubble of the late Saxon masonry structure (Vol. II, p. 52). It was filled with stony soil containing mortar derived from the surrounding layers. It ran parallel to the southern end of the northern sector of gully 16, with which it was broadly contemporary. It contained a few sherds of twelfth- or thirteenth-century pottery.

Correlation of Gully Numbers with Trench and Layer Numbers

Gully	Trench	Layers
1, 2	60	7, 15
	62	9, 10
	67	22
	69	9, 10, 27
	70	28
	71	10, 42, 43, 45-53
	3	62
67		25
68		5
75		21
76		27
4	60	14
5	68	6
6	57	4, 8
	85	6, 3
7	57	9
8	57	10
	85	7
9	73	7, 11, 12
	74	6
5		

Gully	Trench	Layers
9	75	7, 42
	76	26
	98	10, 15, 16, 22, 24, 25
	85	25
11	85	25
16	94	49, 53
	95	32, 41
	96	44
	97	52, 54
	98	44
	100	61, 62
	101	19, 32, 33, 116
	95	93
17	95	93
18	95	102, 117
19	97	26, 34, 50
20	97	36
21	97	41
28	96	30, 45
29	97	57
	98	48, 61
30	98	35
31	98	24
32	98	26, 27, 33, 56, 57, 58
33	98	42, 55
35	99	52
37	101	16, 30
38	72	40

THE LIMEKILNS

The area excavation in the south-west quarter of the fort exposed two limekilns of different structure and date: kiln 1 belonged to the thirteenth century; kiln 2 to the late fourteenth century. Together they provide an interesting insight into the technological improvements effected in the lime-making process during the medieval period. That both kilns were situated close together away from contemporary buildings may well imply that this part of the fort was regarded as the proper place for industrial activities likely to cause offence to the castle's residents. The situation was also convenient if, as seems likely, the lime was to be used to repair the adjacent fort wall.

Limekiln 1 (fig. 64)

Limekiln 1 appeared, during the course of excavation, to be two adjacent pits which were accordingly given pit numbers (pits 131 and 132). It was only after the work had progressed that it was realized that the pits, which proved to intercommunicate, constituted a limekiln (pl. XXIa).

The main pit, pit 132, or kiln chamber, was 9 ft. (2.74 m.) square and dug to a depth of

7 ft. (2.13 m.) below the contemporary surface. It was unlined, but firing had baked the brickearth through which it was cut to a bright red colour. The smaller pit (pit 131) served as a raking pit. It was elongated, 9 ft. (2.74 m.) long by a maximum of 5 ft. (1.52 m.) wide, with a bottom sloping from 3 ft. (0.91 m.) deep at the west end to 7 ft. (2.13 m.) at the east. From the east end a tunnel 2 ft. 6 in. (0.76 m.) wide and 1 ft. 8 in. (0.51 m.) high had been cut to join the two pits. The tunnel walls and floors, together with the adjacent floor of the raking pit, showed signs of having been subjected to intense heat. The kiln chamber still contained a thick layer of partly burned chalk which must have represented the remnants of its last load. After disuse the pits were allowed to fill with soil and rubbish (described on pp. 83-5) containing pottery of the thirteenth century (pp. 153-5).

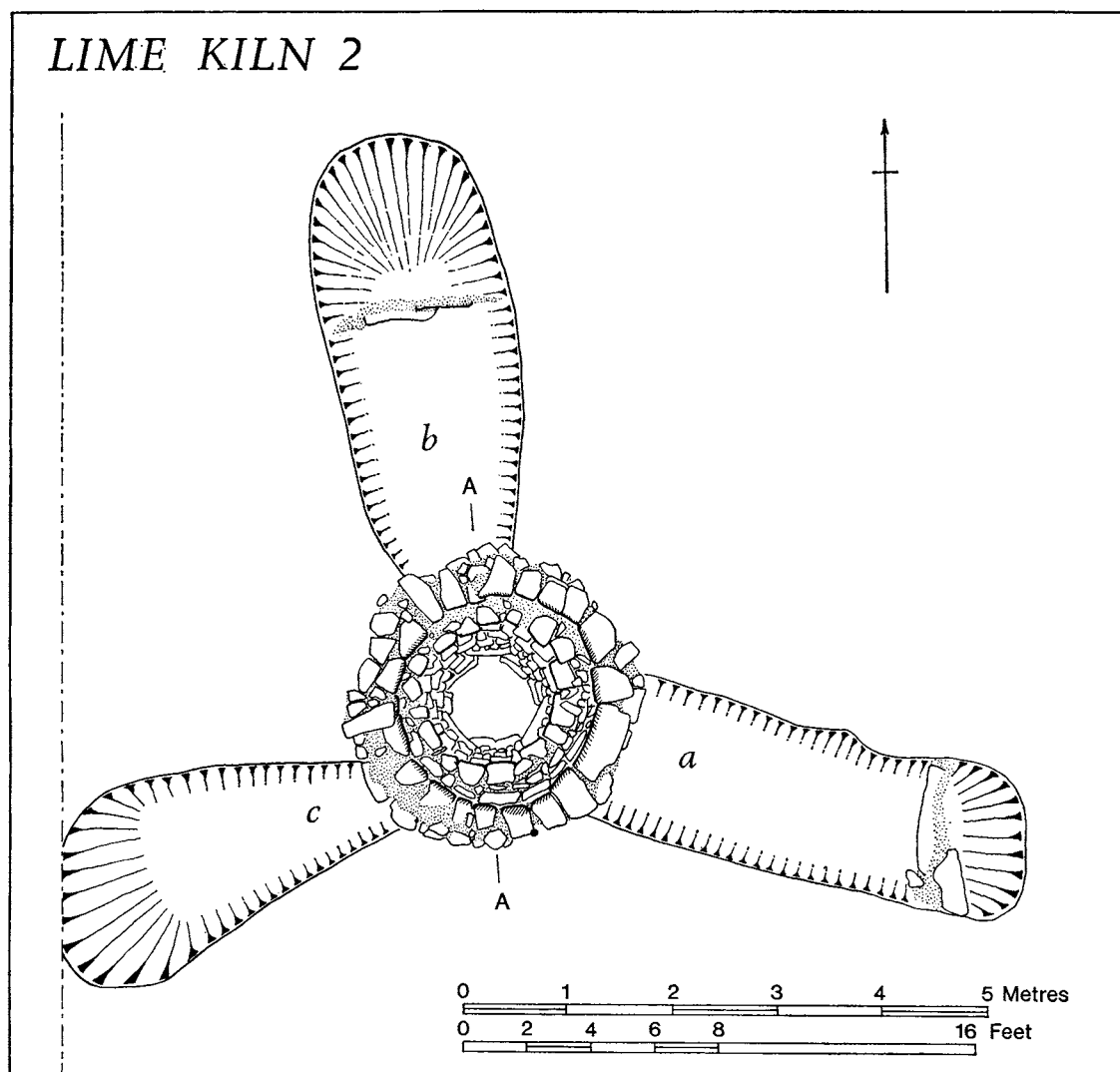

FIG. 22

Limekiln 2

(figs. 22, 23, and pls. XIX, XX)

The principal characteristics of this kiln, which consisted of a circular chamber served by three raking pits, will be readily apparent from the plan, sections and photographs. The central chamber, built of large freshly quarried blocks of limestone set in clay and mortar,

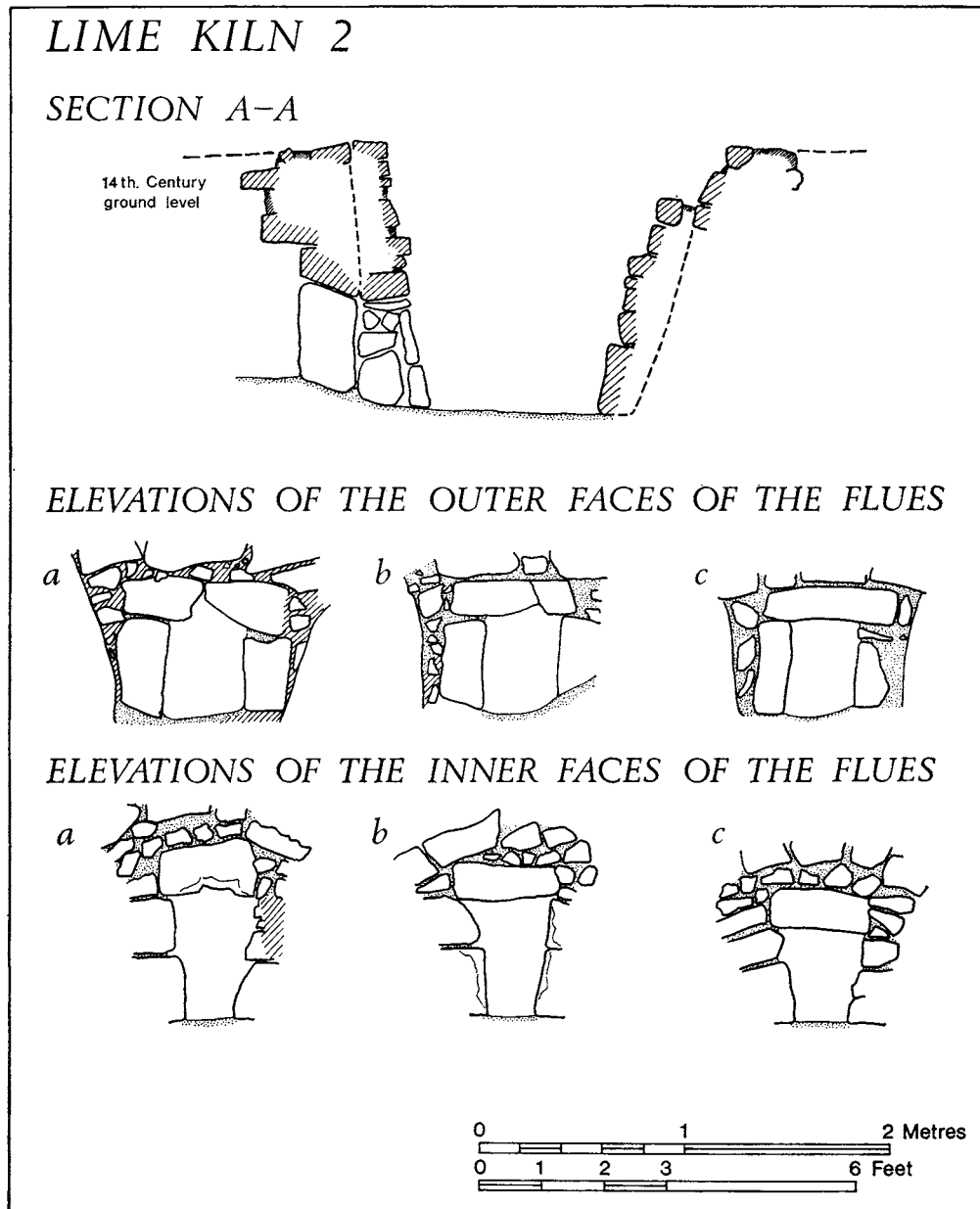

FIG. 23

showed two phases of construction. In the first, the diameter of the chamber at ground level measured 6 ft. (2 m.) across, but after at least one firing which reddened the faces of the stones, its volume was reduced, by the addition of one inner skin of stone blocks, to 4 ft. (1.22 m.) in diameter. In both phases, the chamber narrowed towards the bottom in the shape of an inverted, truncated cone. The walls survived to a height of 4 ft. 6 in. (1.37 m.) above the base of the chamber, the upper part of the structure having been destroyed to the contemporary ground surface. Their original height cannot now be estimated with any degree of accuracy, but the absence of any elaborate structure such as a ramp to allow the loads of chalk to be raised to the lip of the chamber suggests that the chamber walls were unlikely to have stood more than 3 ft. (1 m.) or so above ground, otherwise shovelling from a chalk cart into the kiln would have been made too laborious.

The provision of three raking flues, each opening into the main chamber through basal vents, would have facilitated the removal of the lime while at the same time allowing a constant supply of air to be drawn into the kiln chamber. Two of the raking flues, A and B, were provided with stone slabs for the raker to stand on well clear of the kiln itself.

After the kiln had fallen into disuse, rubble from the superstructure, together with soil, accumulated in the main chamber and in the raking flues.

Dating must depend largely upon the small group of pottery from levels immediately following the kiln's use, for which a date in the fourteenth century is argued below (p. 171). The stratigraphical position of the kiln in relation to the building of the storehouse in the early sixteenth century is best demonstrated on section 9 (fig. 124), where the level denoted by trench 101, layer 57 and trench 103, layer 114 represents the ground level contemporary with the kiln's active life. After disuse, 1 ft. (0.30 m.) of stony grey soil accumulated (trench 101, layer 51) before a turf line formed (trench 101, layer 12). It was from this level that the storehouse footings were cut in the 1520s. Thus a considerable period of time intervened between the abandonment of the kiln and construction of the storehouse.

One plausible use for the kiln would have been to provide the lime needed in the great rebuilding programme undertaken in 1396–99, during which time the domestic quarters of the castle were largely rebuilt, but this is unlikely since a large kiln is recorded to have been constructed for this purpose at the base of Portsdown a mile or so to the north. Another context is offered by the extensive repairs carried out to the walls in 1369. The kiln would have been conveniently sited to provide lime for the repair work of approximately this date which appears to have been carried out on the south wall of the fort. Such close dating is however impossible on the basis of the pottery alone, and it must be allowed that any of the late fourteenth-century building undertakings could have led to the kiln's construction.

Details of Stratigraphy

Adjacent rubbish spreads (= destruction)	trench 89, layer 8a trench 90, layer 8
Filling of chamber	trench 90, layer 17
Filling of raking pits	trench 89, layer 24 trench 90, layers 13, 14 and 15
Adjacent contemporary occupation	trench 90, layers 10 and 21

The Use of the Kilns

The process of lime-making entailed the filling of a pit or specially constructed kiln chamber with layers of broken chalk or limestone interleaved with fuel, most usually charcoal. When the chamber had been filled the fuel was ignited, the heat slowly converting the chalk (calcium carbonate) to lime (calcium oxide). Air was necessary to allow the charcoal to burn. In kilns provided with raking pits, the lime thus formed could be raked out from the base of the main chamber while further supplies of chalk and fuel were tipped in at the top. In this way the process could continue without a break until sufficient lime had been produced (see Singer, 1967, pp. 346-57).

Kiln 1, constructed wholly below ground and with its single raking pit, would have been easy to fill but laborious to extract the lime from. Such a structure, comparatively simple to construct, would have been suitable for producing a limited amount of lime quickly, but is unlikely to have remained serviceable for long. Kiln 2, on the other hand, was of more advanced design and could have functioned with ease over long periods. The hopper-like shape of the chamber would have ensured a steady fall of properly converted lime while the provision of three raking pits would have allowed the lime to be removed expeditiously. The difference in the two structures, therefore, probably reflects the tasks for which they were designed rather than their different dates.¹

PITS

Altogether some 42 pits of medieval date were discovered during the excavation. Of these 38 were rubbish or cesspits. The total compares with 57 of Saxon date and 77 of the Roman period from the same area. Evidently some decrease in activity or difference in use is indicated. In support of this it may be remarked that no well of medieval date was found in the area compared with six Roman and four Saxon.

In the following pages each pit is illustrated and briefly described, together with a list of the artifacts and animal bones found within it. No attempt has been made here to describe pottery, but reference is given to the section on pottery where the contents of each pit group is illustrated and described in detail. Small finds are all listed with reference to the appropriate detailed reports and a quantitative summary is given of the animal bones. The number following the name of the species is the percentage of the total number of fragments identified, excluding ribs and skull fragments (but including upper jaws with teeth present and horn cores). Where no percentage is given the species forms less than 0.5% of the total. Percentages are corrected to the nearest whole number. Where no percentages are given for a pit, it was considered that too few fragments were found for such an analysis to be meaningful. The order of species given for each pit is their order of importance in that pit.

¹ The Portchester limekilns should be compared with those excavated in Southampton (Platt and Coleman-Smith, 1975, vol. 1, p. 298, figs. 97, 98). Minor differences

will be noted. Together, the two sites provide an interesting range of evidence.

Pit 2 (PC 61, trench 1, pit B)

Square pit 6 ft. by 6 ft. 9 in. (1.83×2.06 m.) cut into the angle between the back face of the Roman fort wall and the internal face of the inturned Roman gate wall. Cut to a depth of 1 ft. 7 in. (0.48 m.) below the surface of the natural brickearth, i.e. 3 ft. 9 in. (1.14 m.) below the contemporary ground surface.

Two distinct fillings were recognized: the lower, some 11 in. (0.28 m.) thick, consisted of crumbly brown cesspit filling. Above this was a layer of black soil mixed with large flint nodules. The pit was partially sealed by a layer of clay which covered the adjacent area.

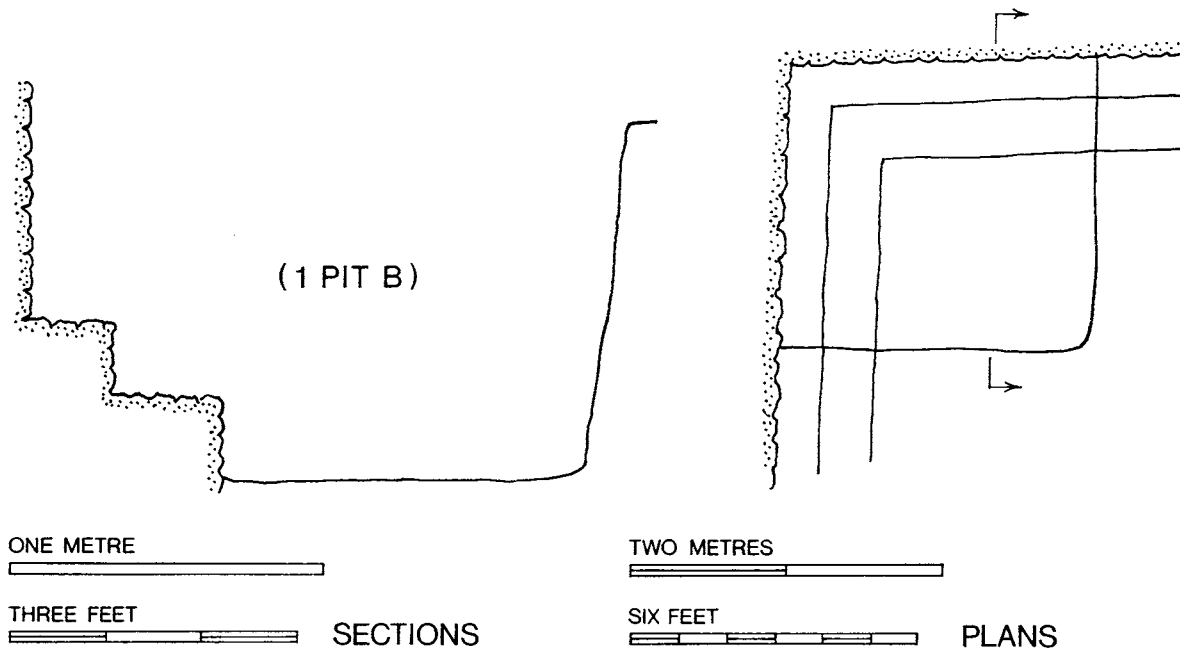

FIG. 24. Pit 2

Pottery (figs. 76-7, nos. 1-18, pp. 138-41)

Early medieval tradition: twelfth-century. Probably early within this period if the sealing clay layer was contemporary with the construction of the landgate (p. 18).

Pit 4 (PC 61, trench 1, pit D)

Large rectangular pit 12 ft. by c. 8 ft. (3.66×2.44 m.) cut against the face of the inturned Roman gate wall to a depth of 4 in. (0.10 m.) below the surface of the natural brickearth, i.e. 2 ft. 5 in. (0.74 m.) below the contemporary surface.

The filling was uniform, consisting of large numbers of loosely packed flints mixed with clay and dark grey soil. It was sealed by a layer of clay.

Pottery (p. 141)

Early medieval tradition: twelfth-century.

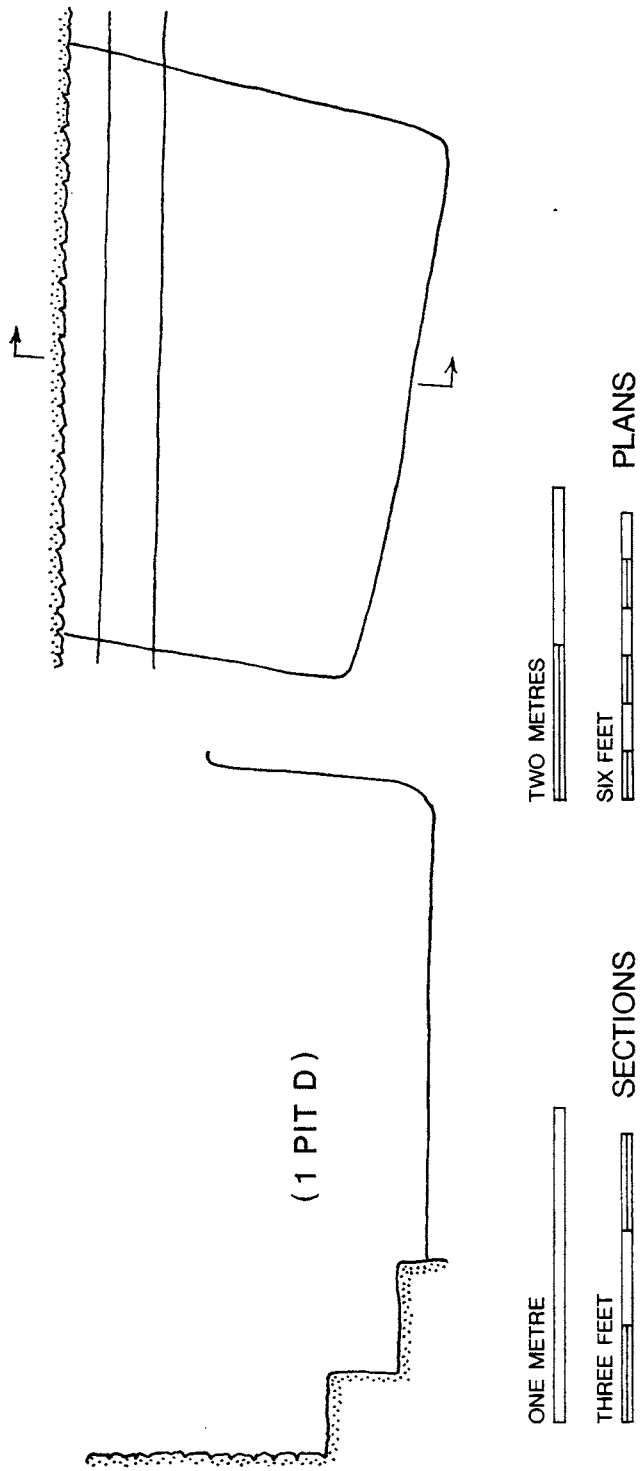

FIG. 25. Pit 4

Pit 6 (PC 61, trench 2, pit C)

Rectangular pit 7 ft. 4 in. by 4 ft. (2.24 × 1.22 m.) cut to a depth of 1 ft. (0.30 m.) below the surface of the natural brickearth, i.e. 2 ft. 6 in. (0.76 m.) below the contemporary surface. Cut through the filling of pit 8.

Uniform filling of grey mortary soil containing fragments of slate.

Pottery (p. 141)

A few sherds, probably twelfth- to thirteenth-century.

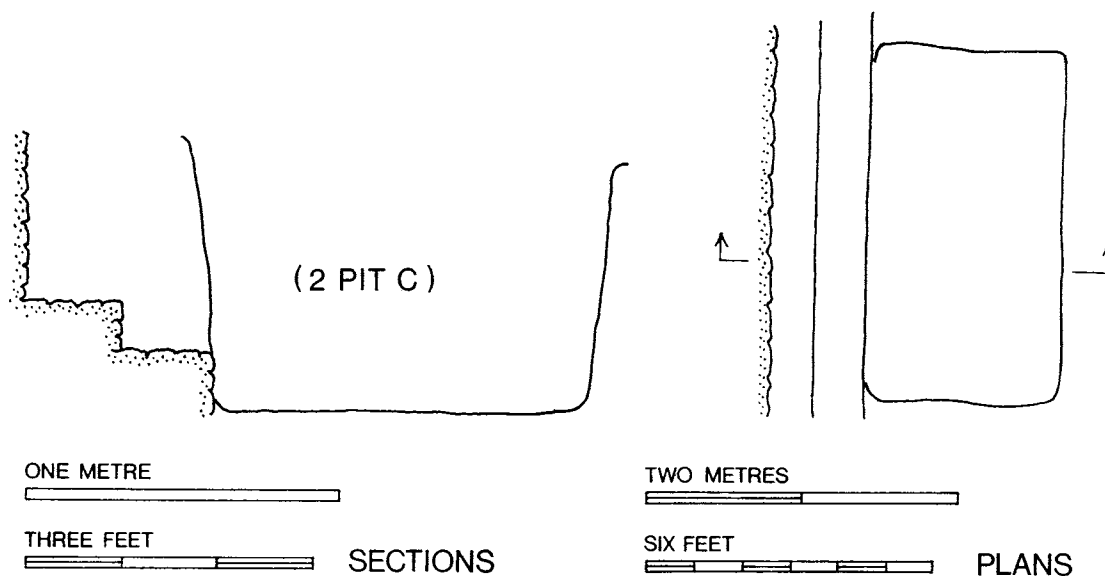

FIG. 26. Pit 6

Pit 8 (PC 61, trench 2, pit E)

Oval-shaped pit 5 ft. 9 in. by 3 ft. 9 in. (1.75 × 1.14 m.) cut to a depth of 2 ft. 6 in. (0.76 m.) below the surface of the natural brickearth, i.e. 3 ft. 10 in. (1.17 m.) below the contemporary surface. Cut by pit 6.

The filling was uniform, consisting of light grey soil mixed with a few large flints.

Pottery (p. 141)

A few sherds only, probably thirteenth-century.

Pit 11 (PC 61, trench 3, pit C) (pl. XVa)

Circular stone-lined pit measuring *c.* 5 ft. (1.52 m.) in diameter, internally, at the top. It was dug to a depth of 3 ft. 9 in. (1.14 m.) below the surface of the natural brickearth. Where it had cut through the natural brickearth it was unlined, but the top 3 ft. (0.91 m.), cut

through Roman occupation layers, were lined with a wall, 1 ft. 3 in. (0.38 m.) thick, built dry of flints and stone blocks, butting up to the back face of the Roman wall.

The lowest filling consisted of crumbly brown cesspit fill containing two small finds and large quantities of pottery. The upper 2 ft. 6 in. (0.76 m.) were filled with dark grey soil and large numbers of flints.

Pottery (fig. 78, nos. 19–29; pp. 141–2)

Early medieval tradition: twelfth-century.

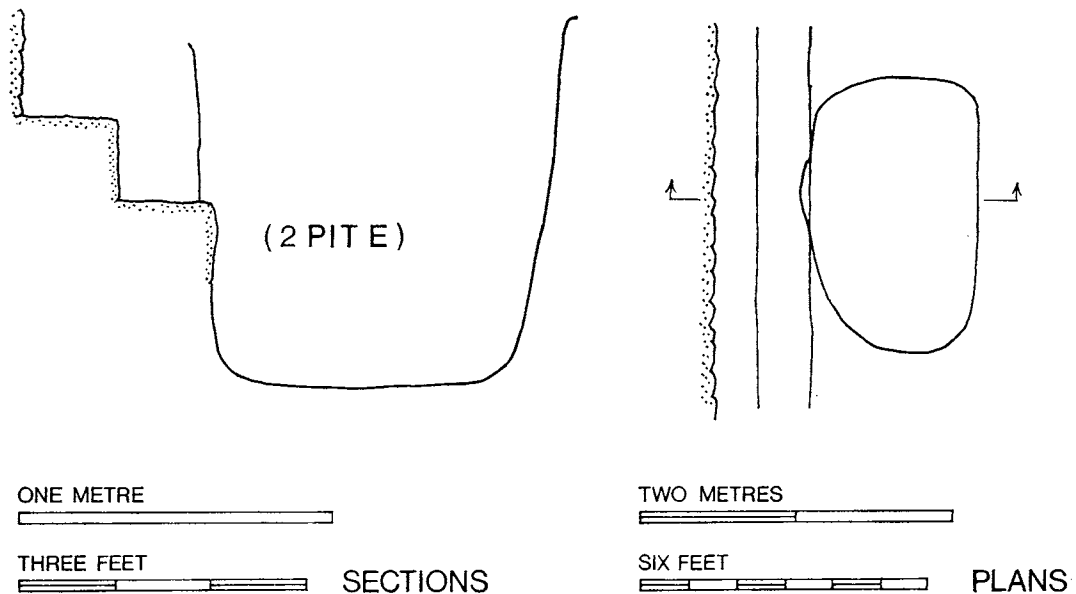

FIG. 27. Pit 8

Small Finds

From the bottom filling:

Iron knife (19): fig. 107, no. 43

Whetstone (18): fig. 111, no. 89

Pit 30 (PC 62, trench 28b, layers 2, 3, 4; PC 69, trench 91, layers 8, 15, 74, 75, 76)

Pit of roughly rectangular shape, 9 ft. by 5 ft. (2.74 × 1.52 m.) dug to a depth of *c.* 10 ft. (3.05 m.) below the contemporary ground surface. The pit was dug close against the wall of Norman date which blocked the south Roman postern gate. It cut through the layers of soil and rubbish which were tipped into the foundation trench after the blocking wall had been completed.

The pit was excavated to the level of the Roman foundations in 1962 (trench 28b); the bottom filling was examined in 1969 (trench 91).

The lowest layer (91, layer 76) consisted of dark grey crumbly soil which became lighter and more stony above, where it was intermixed with brickearth which had eroded from the west side (91, layer 75). Above this (91, layer 74) was a thick layer composed of black soil mixed with large flints. Layers of cesspit filling interleaved with loosely packed flints completed the filling.

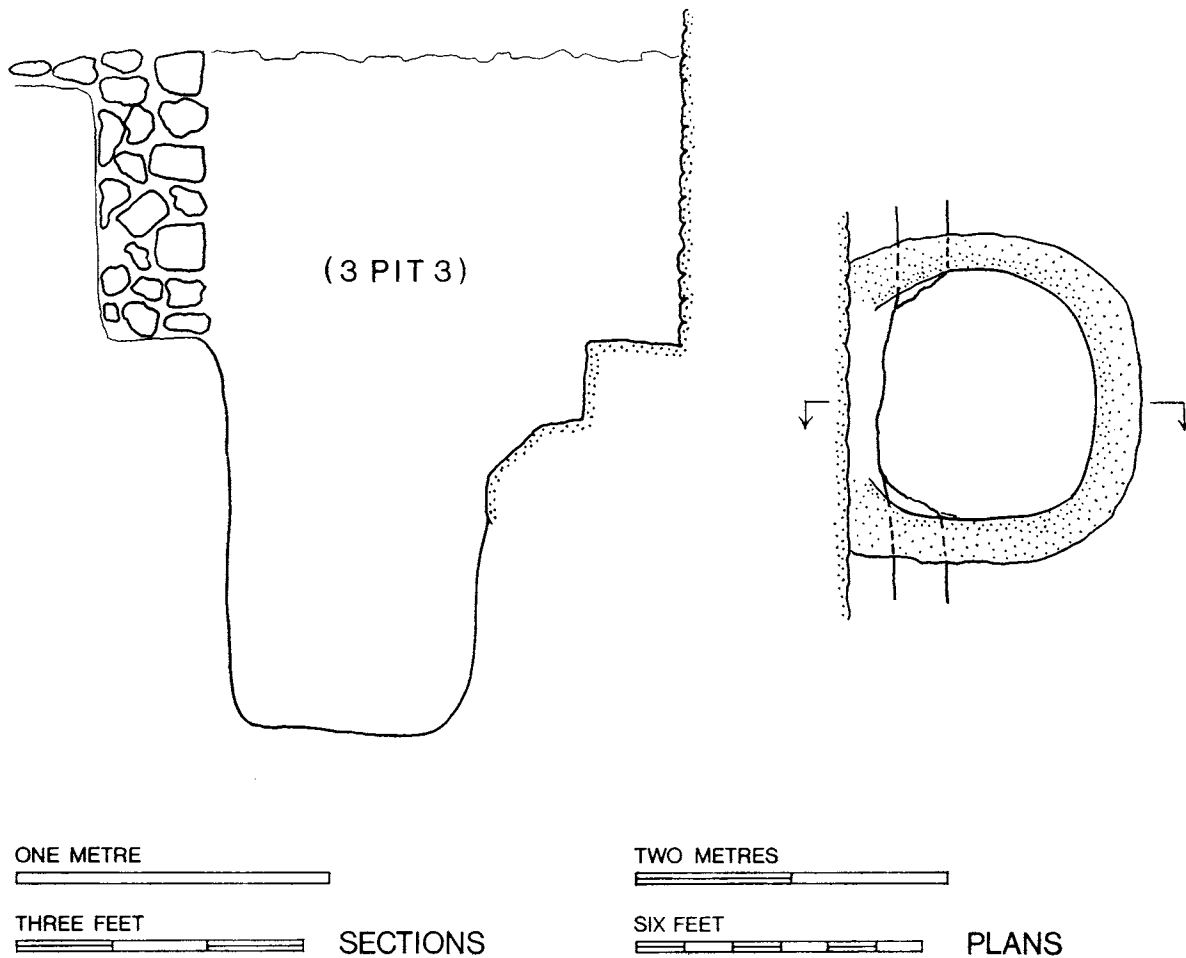

FIG. 28. Pit 11

Pottery (fig. 79, nos. 30-44; pp. 141, 143-4)

Developed medieval tradition: thirteenth-century.

Animal Bones

12 fragments identified (including 2 ribs).

Species represented: cattle, bird, pig, horse, dog, small mammal.

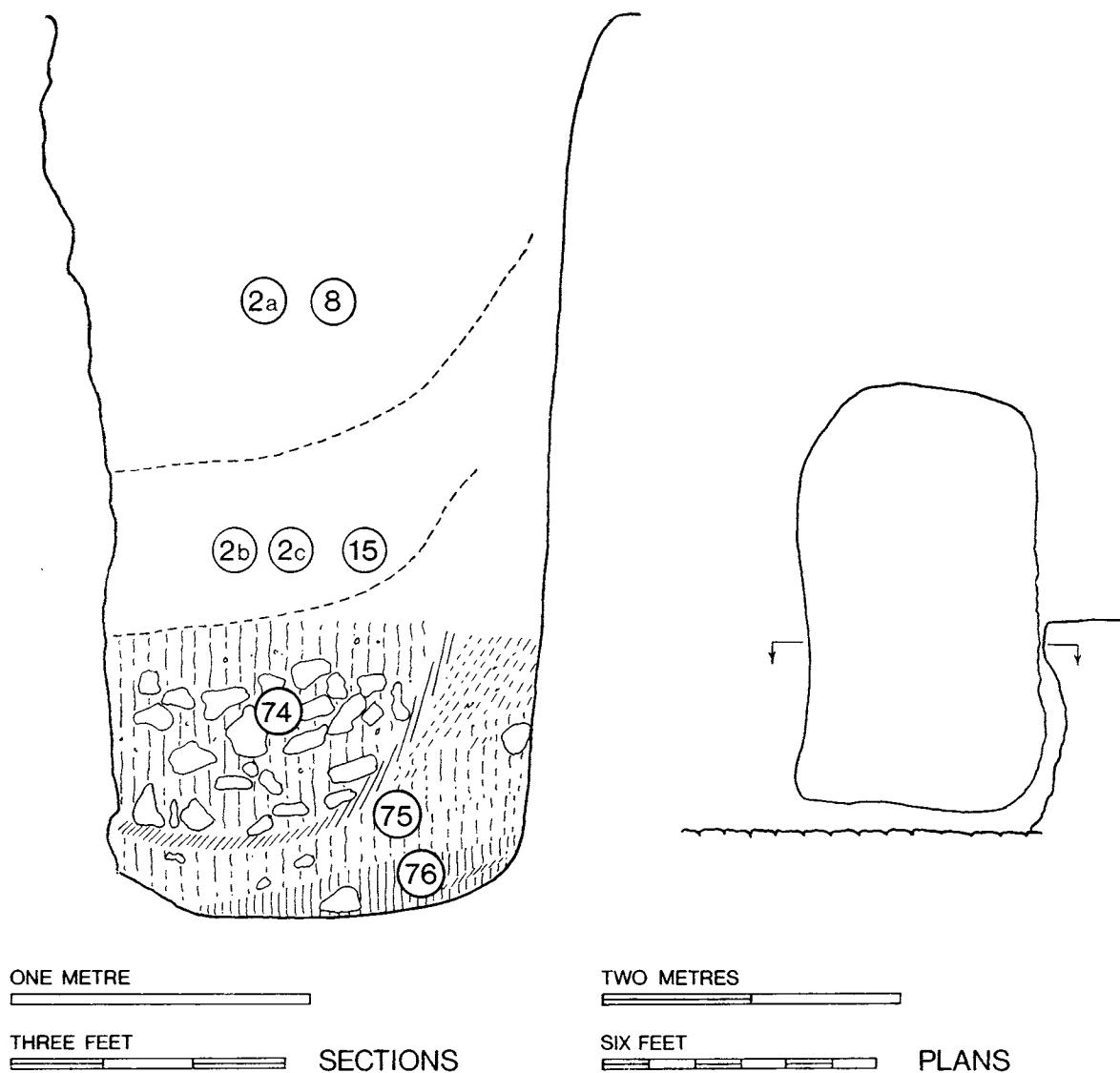

FIG. 29. Pit 30

Pit 31 (PC 63, trench 37, pit A)

Small, roughly circular pit, 3 ft. 6 in. (1.07 m.) in diameter cut through the footings of the Roman watergate to a depth of 1 ft. 9 in. (0.53 m.), i.e. *c.* 5 ft. (1.52 m.) below the contemporary ground level.

The filling was uniform, consisting of grey soil mixed with flints, tiles and mortar rubble. It was sealed by the mortar floor of building M1.

Pottery (fig. 80, no. 45; pp. 144, 145)

Possibly developed medieval tradition: thirteenth-century.

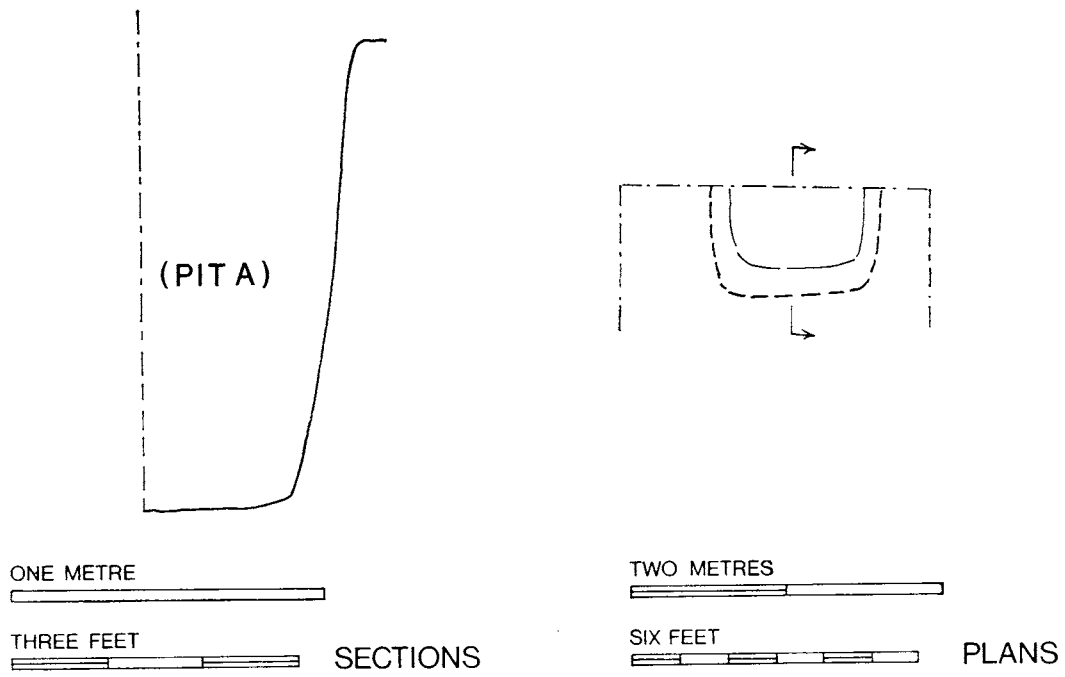

FIG. 30. Pit 31

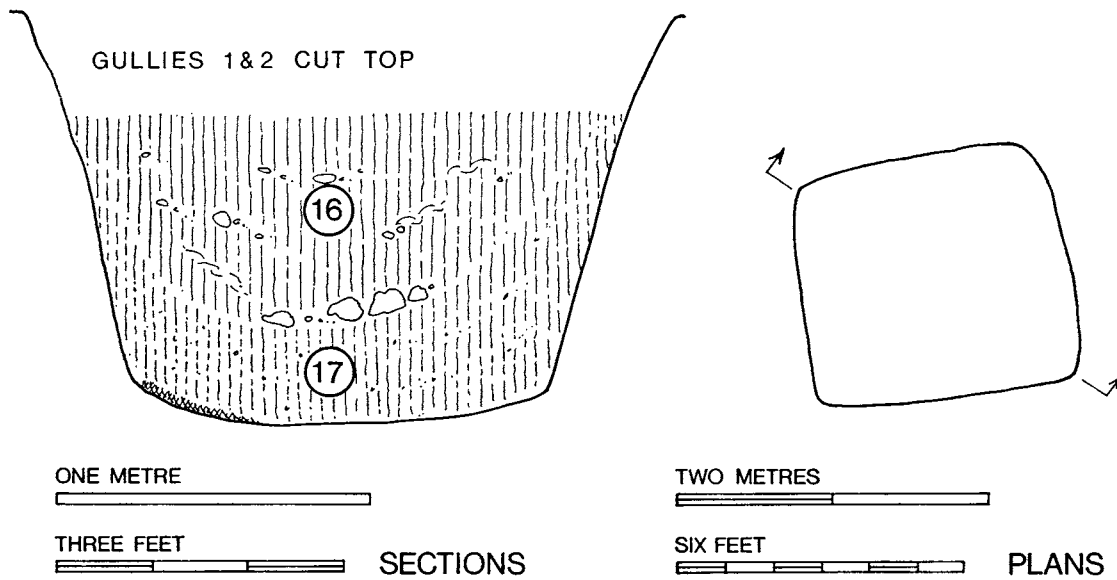

FIG. 31. Pit 44

Pit 44 (PC 66, trench 62, layers 16, 17)

Rectangular pit 5 ft. 9 in. by 5 ft. 3 in. (1.75 × 1.60 m.) cut to a depth of 3 ft. 10 in. (1.17 m.) below the surface of the natural brickearth. The pit was cut by gullies 1, 2 and 3.

The lower filling (layer 17) consisted of a crumbly grey brown cesspit filling with a thin lens of charcoal on the pit bottom. Above this (layer 16) the filling was of black soil mixed with flints, oyster shells, etc. A mass of large flints lay at the interface between the layers.

Pottery (fig. 80, nos. 46-57; pp. 144-5)

Early medieval tradition; twelfth-century.

Small Finds

From layer 16:

Iron horseshoe (180): fig. 106, no. 32

Pit 57 (PC 67, trench 67, layers 9, 26, 32-6)

Rectangular pit 7 ft. by 4 ft. 9 in. (2.13 × 1.45 m.) cut to a depth of 4 ft. 6 in. (1.37 m.) below the surface of the natural brickearth.

The lower layers in the filling (layers 36-2) represented lenses of soil, brickearth and rubbish which had washed in from the sides. Then followed the deposition of a thick layer of black soil mixed with occupation rubbish including oyster shells, bones and pottery (layer 26). The upper filling (layer 9) was principally a deposit of large flints mixed with black soil.

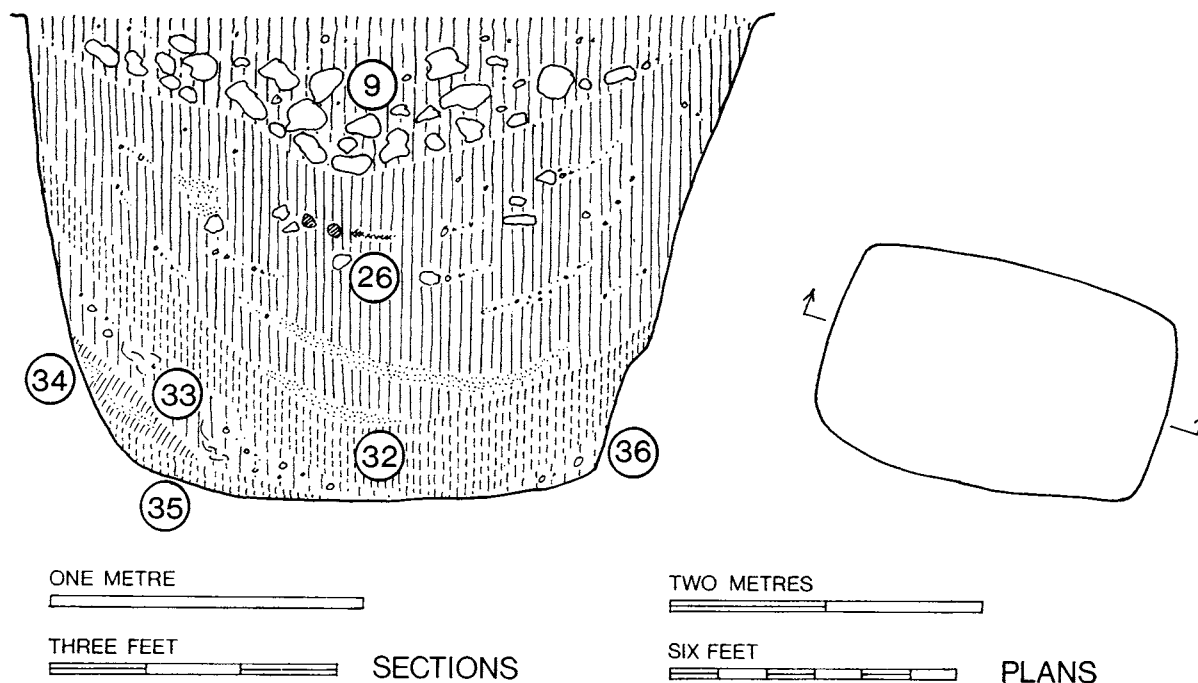

FIG. 32. Pit 57

Pottery (fig. 81, nos. 58-73; pp. 146, 147)

Early medieval tradition: twelfth-century.

Small Finds

From layer 9:

Iron rod, twisted (239): fig. 108, no. 59

Iron horseshoe (287): fig. 106, no. 34

From layer 26:

Bronze fragment (283): not illustrated

Iron chain link (293): fig. 109, no. 67

Iron fragment, ?nail (266): not illustrated

Bone gaming counter (281): fig. 111, no. 83

Animal Bones

179 fragments identified (including 30 ribs and 9 skull fragments).

Species represented: cattle 46, sheep 26, pig 21, bird 5, horse 1, red deer 1.

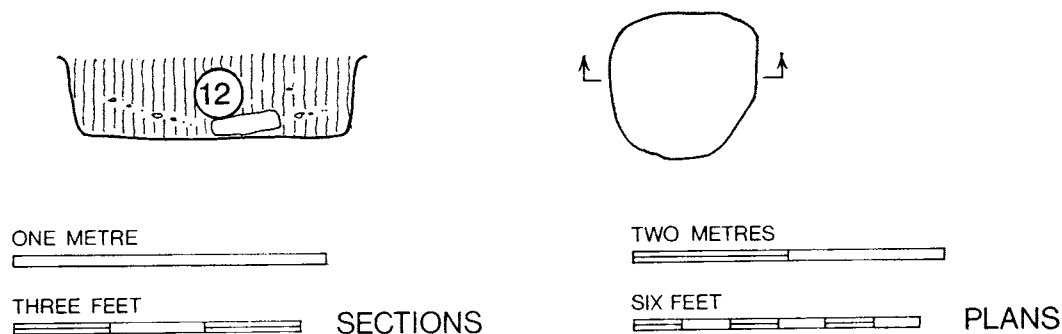

FIG. 33. Pit 75

Pit 75 (PC 67, trench 71, layer 12)

Small circular pit 3 ft. (0.91 m.) in diameter, cut to a depth of 9 in. (0.23 m.) below the level of the natural brickearth.

The filling consisted of grey soil containing some occupation debris and a block of limestone.

Pottery (p. 146)

Sherd only, date uncertain but twelfth- or thirteenth-century.

Animal Bones

2 fragments identified.

Species represented: cattle.

EXCAVATIONS AT PORTCHESTER CASTLE

Pit 78 (PC 67, trench 71, layers 42, 43, 45-51)

This pit was a soakaway connected with gullies 1 and 2. It is described as part of this system on pp. 45-7 and illustrated in figs. 18 and 65.

Small Finds

From layer 42:

Bronze fragment (402): not illustrated

Animal Bones

51 fragments identified.

Species represented: cattle 67, sheep 14, bird 6, pig 4, horse 4, cat 4, red deer 2.

Pit 81 (PC 68, trench 73, layers 40, 49)

Circular pit *c.* 5 ft. (1.52 m.) in diameter, cut to a depth of 3 ft. 4 in. (1.02 m.) below the surface of the natural brickearth. The side of the pit had been cut into by an early nineteenth-century pit.

The lower filling consisted of grey soil containing small stones and occupation rubbish such as bones and oyster shells (layer 49). Above this were tips of grey soil, clay, mortary rubble and large blocks of limestone (layer 40).

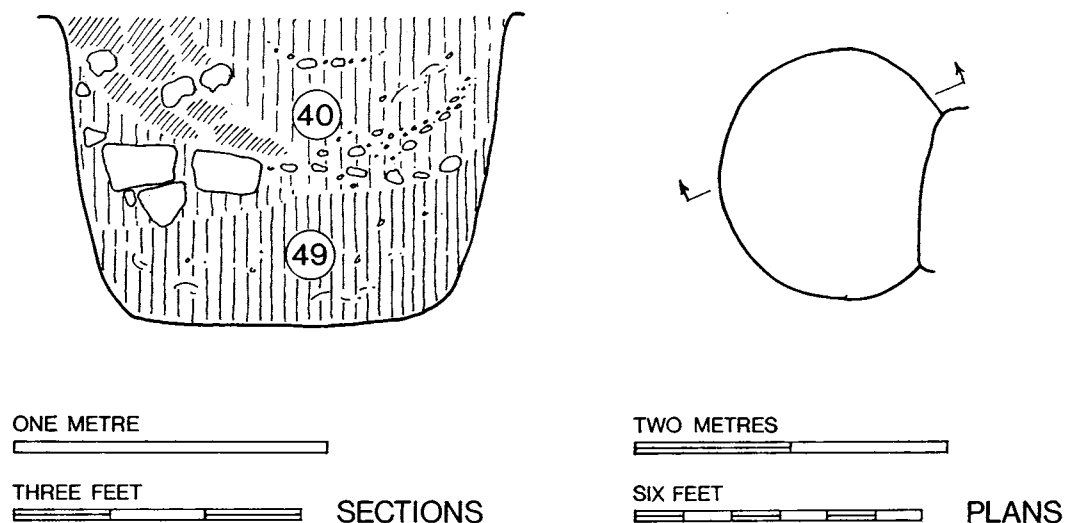

FIG. 34. Pit 81

Pottery (fig. 82, nos. 74-8; pp. 146, 148)

Developed medieval tradition: thirteenth-century.

Small Finds

From layer 40:

Lead fragment (616): not illustrated

Animal Bones

61 fragments identified (including 15 ribs and 1 skull fragment).

Species represented: sheep 27, bird 24, cattle 22, pig 16, roe deer 9, red deer 2.

Pit 96 (PC 68, trench 76, layers 8, 31)

Rectangular pit measuring 6 ft. by 5 ft. (1.83 × 1.52 m.) cut to a depth of 4 ft. (1.22 m.) below the surface of the natural brickearth.

The lower filling consisted of a grey silty soil interleaved with lenses of brickearth eroded in from the sides (layer 31). Above this the pit was filled with black soil which contained tightly packed flint nodules (layer 8).

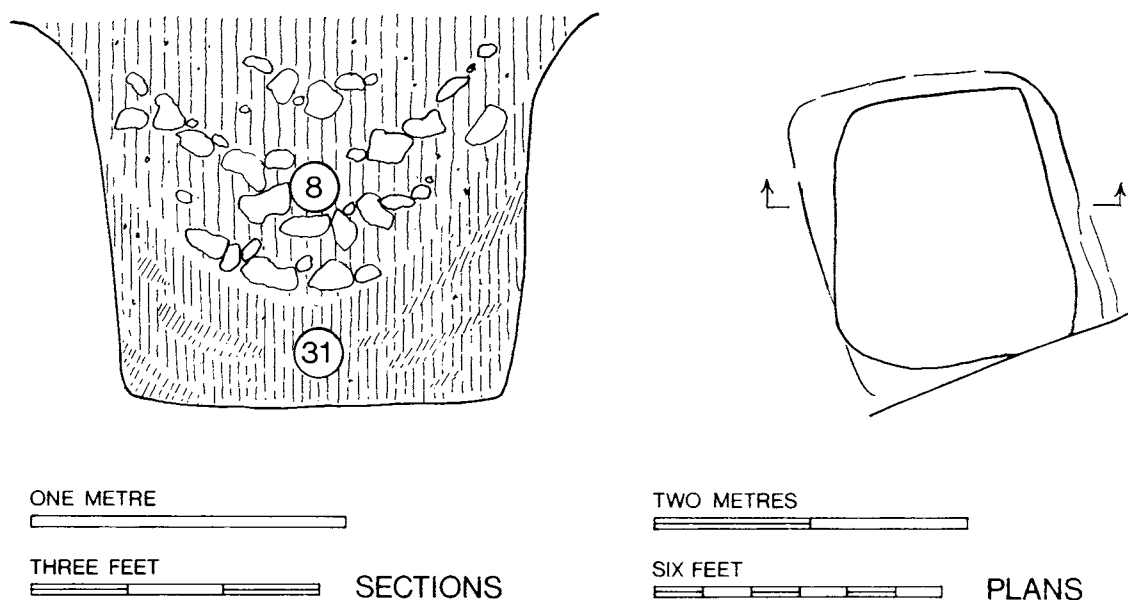

FIG. 35. Pit 96

Pottery (fig. 82, nos. 79–84; pp. 148–9)

Developed medieval tradition: thirteenth-century.

Animal Bones

64 fragments identified (including 12 ribs and 1 skull fragment).

Species represented: cattle 31, sheep 27, pig 18, horse 10, roe deer 4, fallow deer 4, small mammal 4, red deer 2.

EXCAVATIONS AT PORTCHESTER CASTLE

Pit 99 (PC 68, trench 75, layers 6, 32-41, 46-48) (pl. XVb)

Large rectangular pit, measuring 7 ft. by 8 ft. (2.13 × 2.44 m.) at the top; 5 ft. by 3 ft. 9 in. (1.52 × 1.14 m.) at the bottom. Cut to a depth of 8 ft. 6 in. (2.59 m.) below the surface of the natural brickearth.

On the bottom of the pit was a lens of chalky wash from the pit sides (layer 48). This was sealed by a grey-brown cesspit filling (layer 47), which was in turn sealed by grey clayey silt washed in from the pit sides (layer 46). Layers 41 and 39 which followed were of grey soil with mixed occupation material divided by a lens of charcoal (layer 40), the shape of which reflects the subsidence of the lower layers. Layers 35-8 were composed largely of tips of flints, oyster shells and brickearth mixed with grey soil. At this stage a turf line (layer 34)

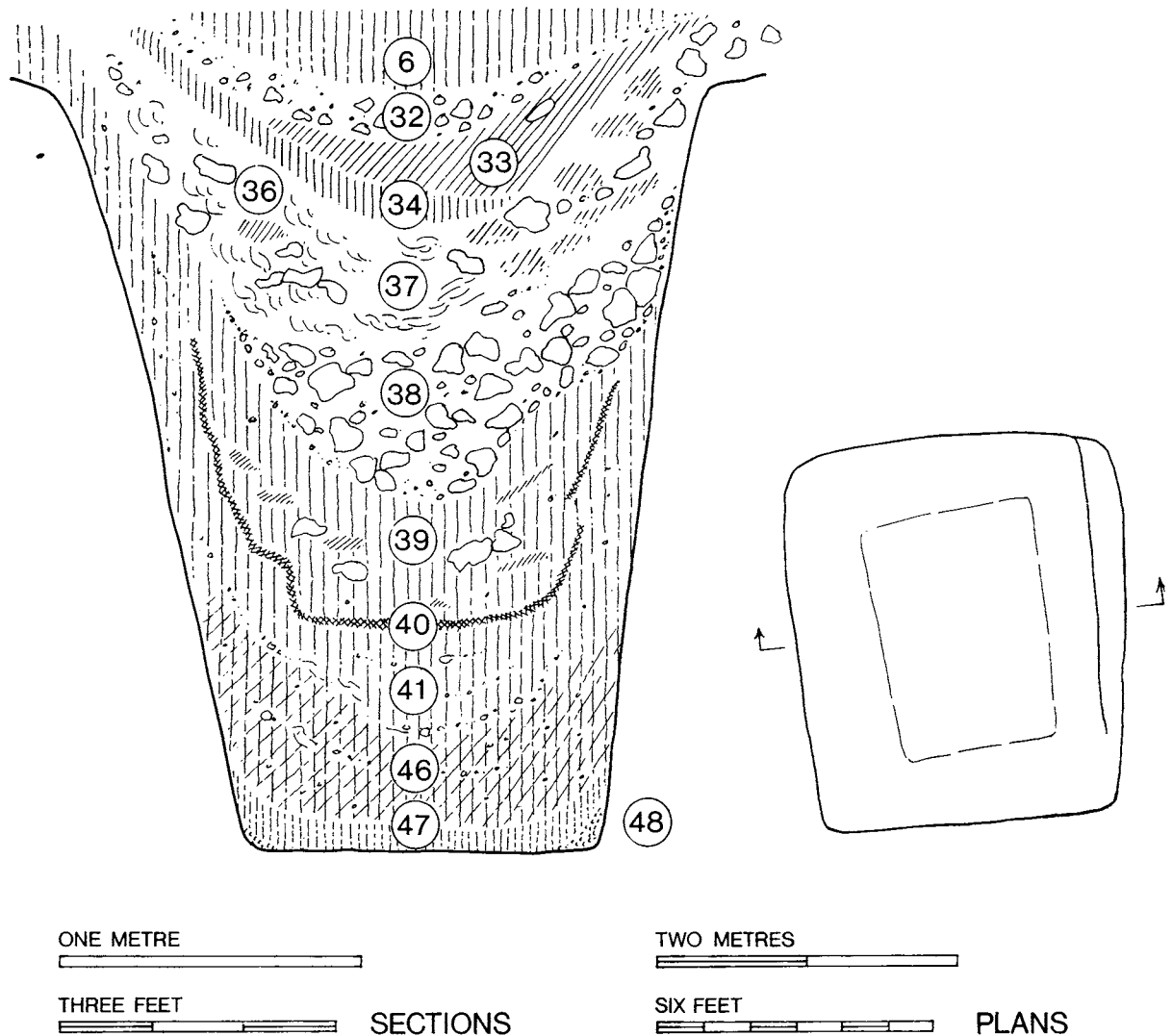

FIG. 36. Pit 99

had formed in the hollow. Then followed a deliberate tip of brickearth (layer 33), a layer of chalk and flint lumps in brown soil (layer 32) and finally an accumulation of soil (layer 6).

Pottery (figs. 82-3, nos. 85-98; pp. 149, 150)

Early medieval tradition: twelfth-century.

Small Finds

From layer 6:

Bronze fragment (719): not illustrated

From layer 34:

Iron knife (763): fig. 107, no. 45

From layer 46:

Iron chain link (790): fig. 109, no. 66

Animal Bones

667 fragments identified (including 244 ribs and 20 skull fragments).

Species represented: bird 38, horse 23, sheep 19, cattle 10, pig 8, dog 1, red deer 1, cat, fallow deer.

This pit had a high percentage of bird and horse bones as well as young sheep.

Pit 100 (PC 68, trench 77, layers 6, 22, 23)

Circular pit 4 ft. 9 in. (1.45 m.) in diameter, cut to a depth of 4 ft. 8 in. (1.42 m.) below the surface of the natural brickearth.

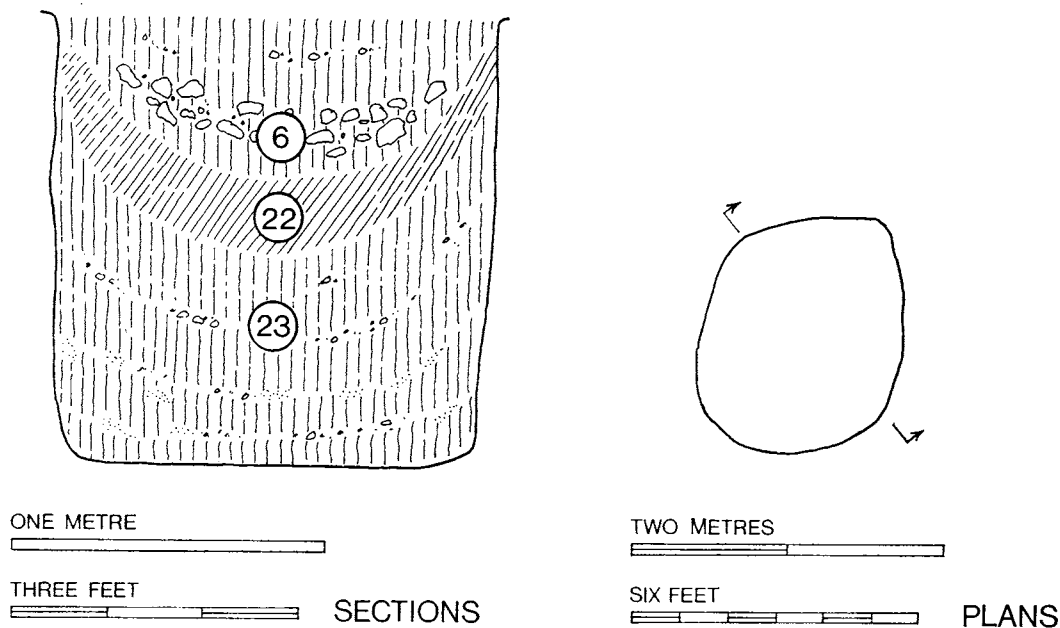

FIG. 37. Pit 100

The lowest filling consisted of black soil containing occupation rubbish including bone and pottery. There were also discontinuous lenses of chalky marl washed in from the pit sides (layer 23). This was sealed by a capping of brickearth (layer 22) above which the hollow was filled with black soil, flints and occupation debris (layer 6).

Pottery (fig. 84, nos. 99-102; pp. 149, 151)

Early medieval tradition?: twelfth-century.

Small Finds

From layer 6:

Stone cresset (744): fig. 112, no. 93

Animal Bones

83 fragments identified (including 19 ribs).

Species represented: cattle 44, sheep 28, pig 17, bird 5, horse 3, red deer 3.

Pit 105 (PC 68, trench 77, layer 31)

Small rectangular pit 3 ft. by 4 ft. (0.91 × 1.22 m.) cut to a depth of 1 ft. 5 in. (0.43 m.) below the surface of the natural brickearth.

The filling was uniform, consisting of black soil mixed with chalk, charcoal and fragments of bone.

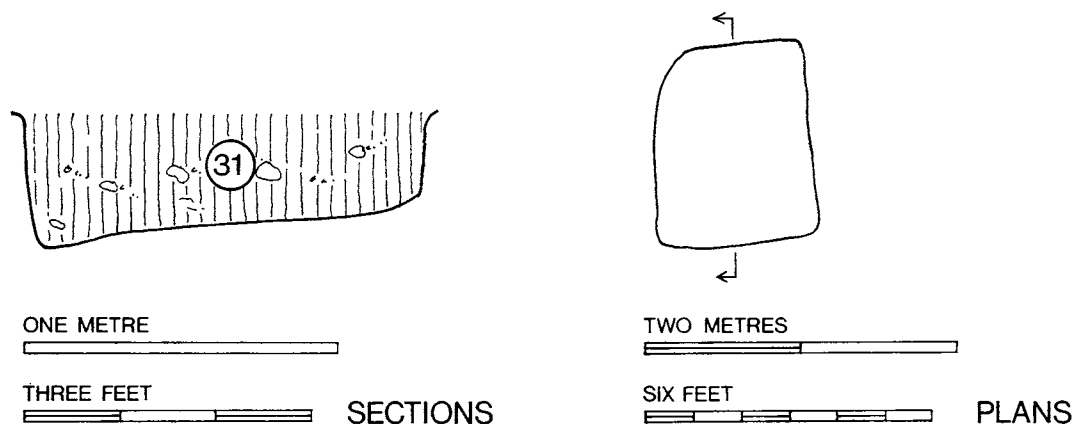

FIG. 38. Pit 105

Pottery (p. 149)

A few body sherds: date uncertain but Saxo-Norman or early medieval tradition: eleventh- or twelfth-century.

Small Finds

Roman bronze coin (785): Constantine II (A.D. 317-22)

Pit 108 (PC 68, trench 79, layers 11, 24, 25, 38, 39, 40)

Roughly circular pit about 4 ft. (1.22 m.) in diameter, cut to a depth of 3 ft. 9 in. (1.14 m.) below the surface of the natural brickearth.

On the bottom of the pit was a discontinuous lens of charcoal (layer 40) which was covered by a thick layer of grey soil containing flecks of chalk (layer 39). This was sealed with a layer of redeposited chalk marl (layer 38) overlaid by fine black soil (layer 25) which was in turn sealed by a thick lens of redeposited brickearth (layer 24). The filling above this consisted of black soil mixed with occupation debris (layer 11).

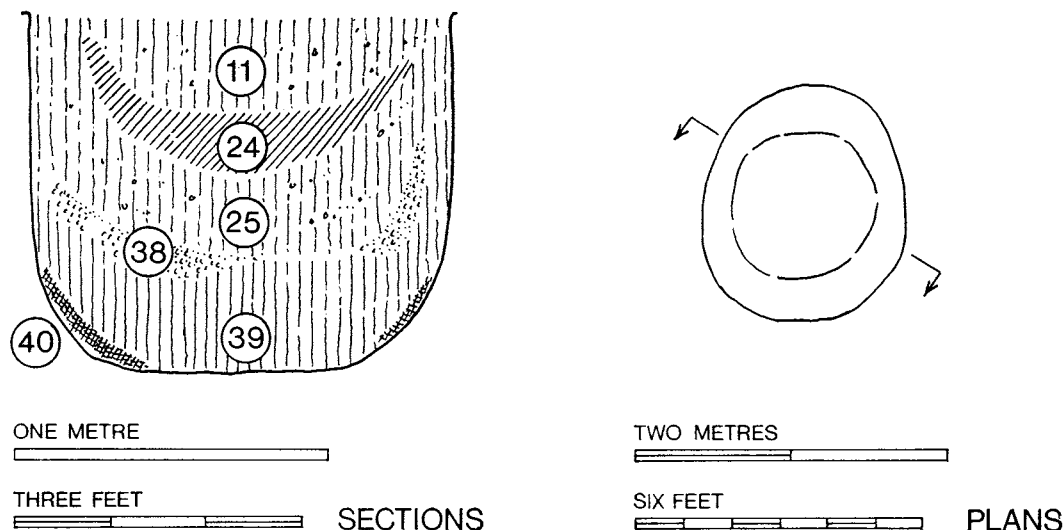

FIG. 39. Pit 108

Pottery (p. 152)

Body sherds of either the Saxo-Norman or early medieval tradition: eleventh- or twelfth-century.

Small Finds

From layer 11:

Roman bronze coin (761): Constans (A.D. 337-41)

Animal Bones

116 fragments identified (including 50 ribs and 9 skull fragments).

Species represented: cattle 35, sheep 23, pig. 19, bird 16, dog 5, red deer 1.

Pit 110 (PC 68, trench 79, layers 34, 42, 43)

Rectangular pit approximately 5 ft. square (1.52 m.) cut to a depth of 4 ft. (1.22 m.) below the surface of the natural brickearth.

The lowest filling (layer 43) consisted of grey soil mixed with flints and occupation debris. This was sealed by a discontinuous lens of brickearth (layer 42). The upper hollow was filled with black soil mixed with some occupation debris.

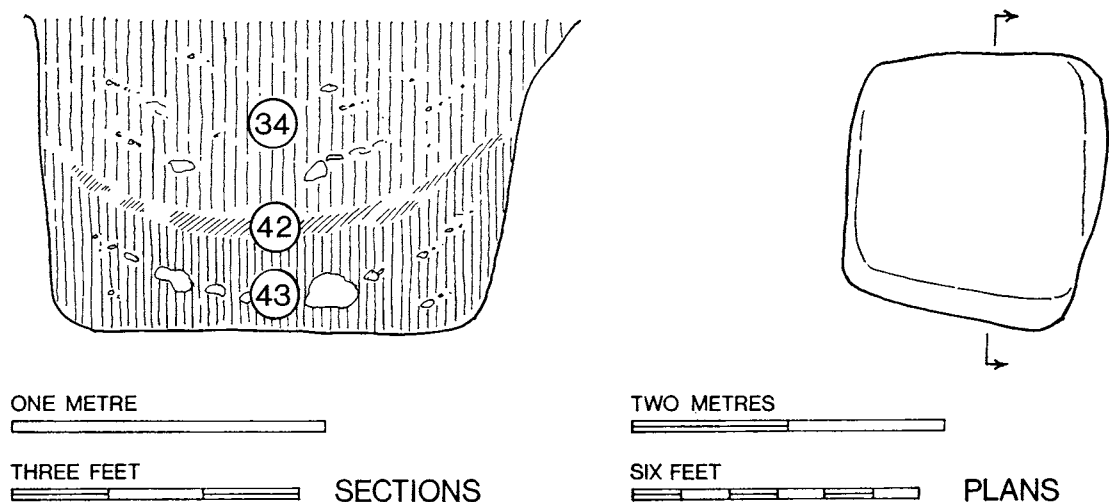

FIG. 40. Pit 110

Pottery (fig. 84, no. 103; pp. 151-2)

Date uncertain, but of the Saxo-Norman or early medieval tradition: eleventh- or twelfth-century.

Small Finds

From layer 34:

Iron chain link (841): not illustrated

From layer 43:

Roman bronze coin (798): Constantius II (A.D. 348-50)

Lead fragment (817): not illustrated

Animal Bones

278 fragments identified (including 73 ribs and 8 skull fragments).

Species represented: cattle 29, dog 28, pig 17, sheep 15, cat 6, bird 5, horse 1.

There was an unusually high percentage of dog bones in this pit.

Pit 112 (PC 68, trench 79, layers 6, 30, 31, 35)

Pit only partly excavated. Cut to a depth of 2 ft. 8 in. (0.81 m.) below the surface of the natural brickearth.

The lowest layer (layer 35) represented brickearth eroded in from the pit sides; above this was a tip of black soil and flints (layer 31) sealed by a layer of brickearth (layer 30). The upper hollow was filled with mixed black soil (layer 6).

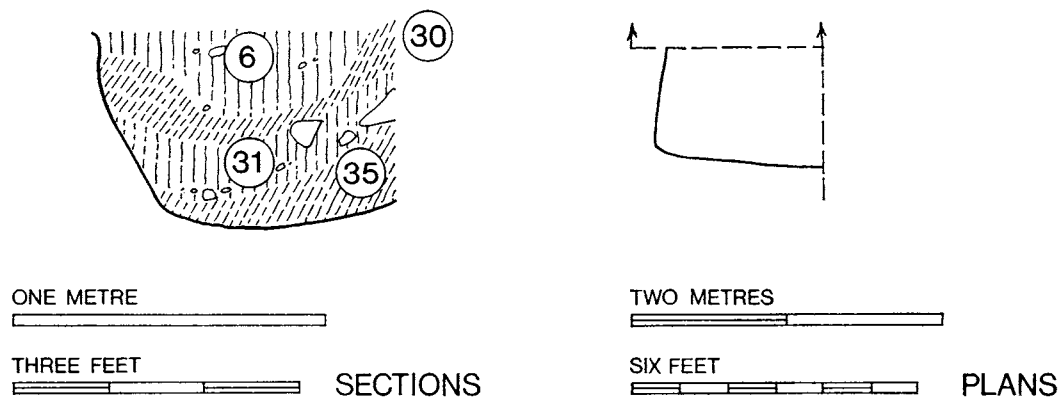

FIG. 41. Pit 112

Pottery (fig. 84, nos. 104-9; pp. 151-2)

Early medieval tradition: twelfth-century.

Small Finds

From layer 6:

Roman bronze coin (760): copy of Urbs Roma (A.D. 330-45)

Animal Bones

66 fragments identified (including 20 ribs and 4 skull fragments).

Species represented: bird 43, sheep 24, pig 19, cattle 14.

Pit 114 (PC 68, trench 73, layers 32, 54, 54a)

Oval pit 5 ft. 6 in. by 3 ft. (1.68 × 0.91 m.) dug to a depth of 4 ft. 9 in. (1.45 m.) below the surface of natural brickearth.

The lowest filling (layer 54a) of fine brown soil, was sealed by a thick layer of redeposited brickearth and marl mixed with lenses of black soil (layer 54). Above this was a layer of grey soil with chalk fragments and occupation debris (layer 32).

Pottery (p. 152)

A few fragments, Saxo-Norman tradition: eleventh-century.

Small Finds

From layer 32:

Lead fragment (846): not illustrated

Animal Bones

105 fragments identified (including 19 ribs and 21 skull fragments).

Species represented: cattle 35, sheep 23, pig 22, bird 17, horse 2, fish 2.

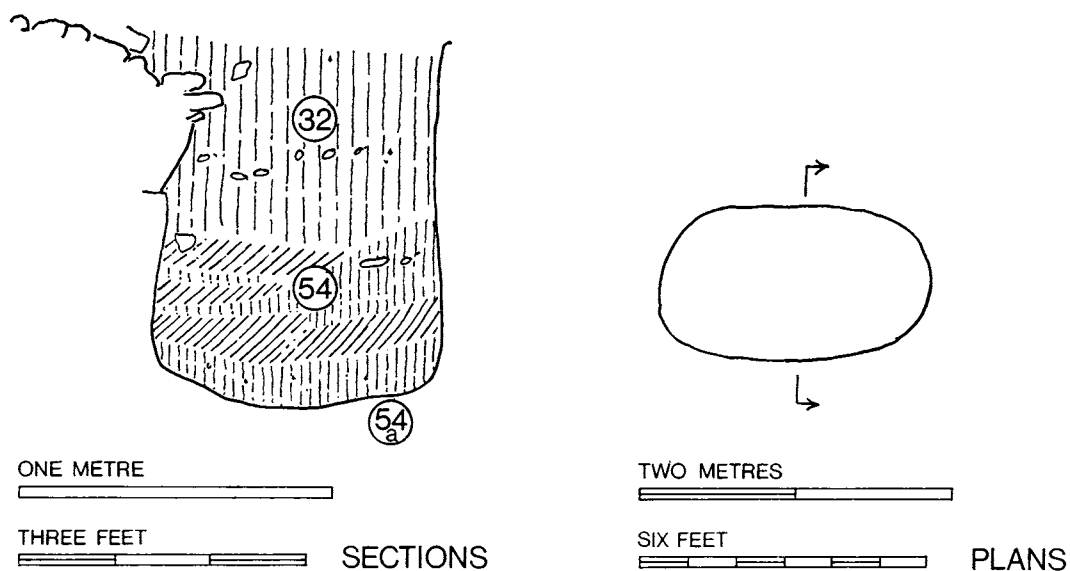

FIG. 42. Pit 114

Pit 116 (PC 68, trench 80, layers 55, 62, 63)

Rectangular pit 6 ft. (1.83 m.) wide, only partially excavated. Cut to a depth of 2 ft. 8 in. (0.81 m.) below the surface of the natural brickearth.

The lower half of the pit was filled with redeposited brickearth (layer 62) interleaved with a layer of black occupation rubbish (layer 63). The upper filling (layer 55) consisted of black soil containing occupation debris.

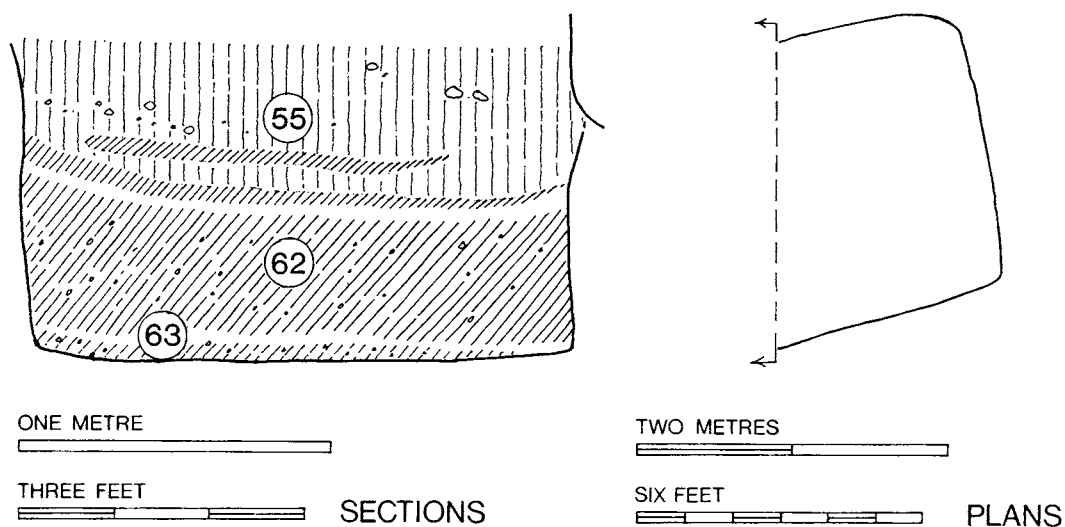

FIG. 43. Pit 116

Pottery (fig. 84, nos. 110-17; pp. 151-2)

Saxo-Norman tradition: eleventh-century.

Animal Bones

73 fragments identified (including 24 ribs and 3 skull fragments).

Species represented: cattle 35, pig 28, sheep 24, bird 13.

Pit 118 (PC 68, trench 80, layers 30, 49-52)

Sub-rectangular pit 4 ft. 6 in. by 5 ft. (1.37 × 1.52 m.) cut to a depth of 2 ft. 10 in. (0.86 m.) below the surface of the natural brickearth.

The lowest layer (layer 52) consisted of brown crumbly soil which was sealed by a thick but discontinuous layer of orange clay (layer 51). Above this was another layer of brown soil containing occupation debris (layer 50) which was also sealed but with redeposited chalky marl (layer 49). The uppermost filling (layer 30) was of black soil containing occupation debris.

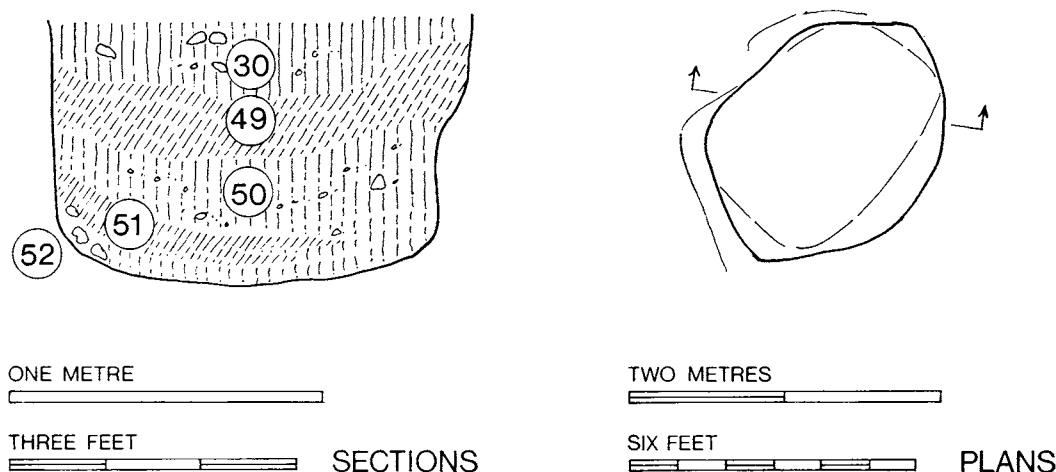

FIG. 44. Pit 118

Pottery (fig. 84, no. 118; pp. 151-2)

Early medieval tradition: twelfth-century.

Animal Bones

28 fragments identified (including 4 ribs and 2 skull fragments).

Species represented: cattle, sheep, pig, bird.

EXCAVATIONS AT PORTCHESTER CASTLE

Pit 120 (PC 68, trench 80, layers 66, 67, 68)

Circular pit 4 ft. (1.22 m.) in diameter, cut to a depth of 1 ft. 8 in. (0.51 m.) below the surface of the natural brickearth.

The lowest fill (layer 68) consisted of dark grey-brown cesspit fill which was sealed by a discontinuous layer of brickearth (layer 67) above which was a layer of brown soil containing stones and occupation debris.

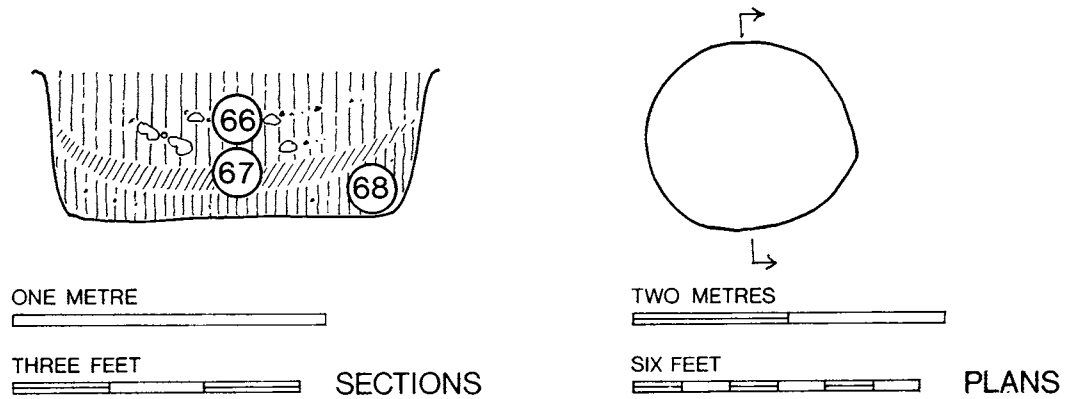

FIG. 45. Pit 120

Pottery (p. 153)

Sherds only, in the Saxo-Norman or early medieval tradition: eleventh- to twelfth-century.

Animal Bones

21 fragments identified (including 7 ribs and 2 skull fragments).

Species represented: cattle, pig, sheep, bird, fallow deer.

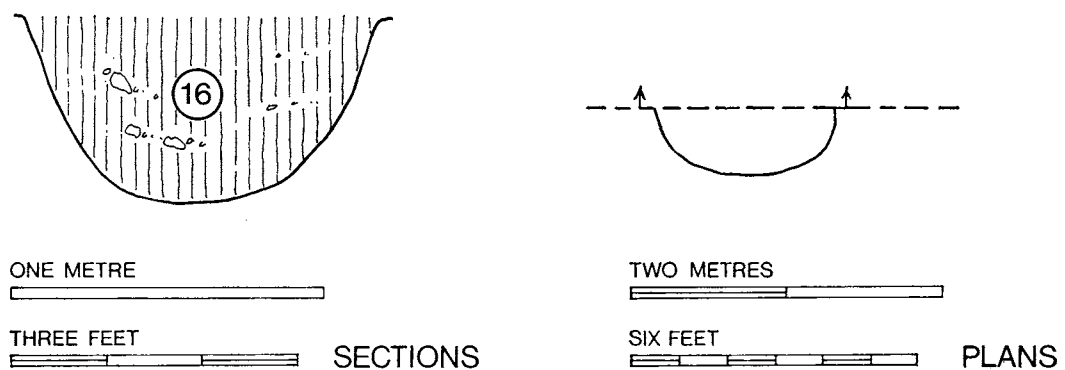

FIG. 46. Pit 123

Pit 123 (PC 68, trench 79, layer 16)

Circular (?) pit 4 ft. (1.22 m.) across, but only partially excavated. The sides sloped to a bottom 2 ft. (0.61 m.) below the surface of the natural brickearth.

Filled with black soil containing some occupation debris.

Pottery (p. 153)

Sherds only, of the early medieval or developed medieval tradition: twelfth- or thirteenth-century.

Pit 125 (PC 68, trench 82, layer 18)

Corner of a shallow pit of unknown dimensions, cut to a depth of 1 ft. 4 in. (0.41 m.) below the surface of the natural brickearth.

Filled with a layer of black soil, mixed with some occupation debris, and large flints (layer 18b), which was sealed by a layer of brickearth (layer 18a).

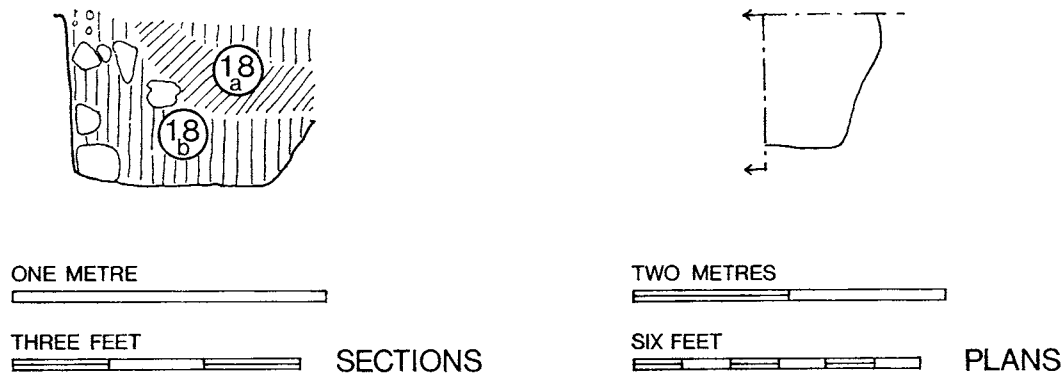

FIG. 47. Pit 125

Pottery (p. 153)

Sherds only, date uncertain, early medieval?

Pit 126 (PC 69, trench 87, layer 21)

Although originally recorded as a pit, this feature may well be a re-cut posthole belonging to building M2. It consisted of a square hole some 2 ft. (0.61 m.) deep filled with black soil and occupation rubbish, into the side and filling of which a circular posthole 1 ft. 4 in. (0.41 m.) in diameter at the base had been cut (see p. 39).

Pottery (p. 153)

Fragments only, date uncertain.

Animal Bones

3 fragments identified.

Species represented: pig, cattle.

EXCAVATIONS AT PORTCHESTER CASTLE

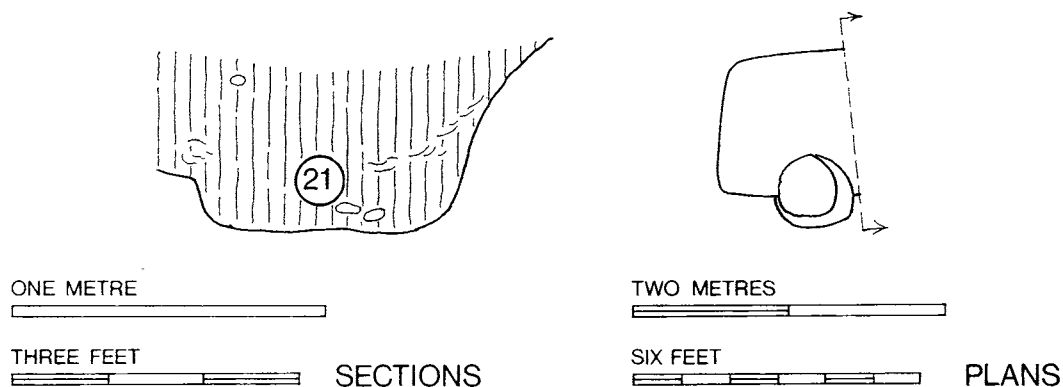

FIG. 48. Pit 126

Pits 127 and 128 (PC 69, trench 87, layer 37 (pit 127), and layer 38 (pit 128))

Two inter-cut pits of rectangular form partially exposed at the eastern limit of the excavation. Pit 128 was cut to a depth of approximately 3 ft. 6 in. (1.07 m.) from the contemporary ground level; pit 127 was some 4 ft. 6 in. (1.37 m.) deep.

Both pits were filled with uniform tips of blackish brown soil with occasional flints and stones. Layer 7 is the lower part of a continuous layer of soil which sealed the area.

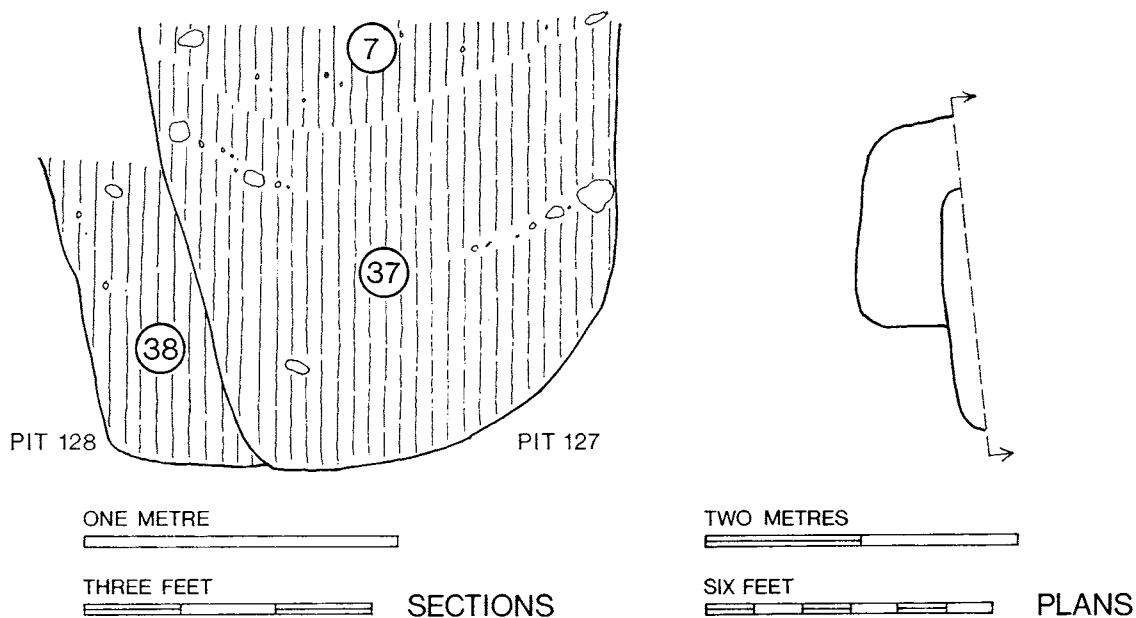

FIG. 49. Pits 127 and 128

Pottery (fig. 84, no. 119; pp. 151, 153)

From pit 127, cooking pot sherds of uncertain date.

From pit 128, cooking pot of the twelfth or thirteenth century.

Animal Bones

From pit 127: 4 fragments identified.

Species represented: pig, sheep, cattle.

From pit 128: 118 fragments identified (including 23 ribs and 9 skull fragments).

Species represented: cattle 71, pig 12, sheep 10, dog 5, bird 1, red deer 1.

Pits 131 and 132 (PC 69, trench 89, layers 31, 31a, 34, 56, 62, 63 (pit 131), and layers 32, 57-9, 61, 70 (pit 132))

These two pits were cut adjacent to each other, 3 ft. (0.91 m.) apart but intercommunicating at the base by means of a tunnel 2 ft. 6 in. (0.76 m.) wide and 1 ft. 8 in. (0.51 m.) high. The form of the pits has been discussed above (pp. 56-7) where it is suggested that they constituted a limekiln. Here the fillings will be considered.

Pit 131

The lowest layer (layer 63) consisted of lumps of chalk lying on the pit bottom sealed by a fine crumbly brown soil containing a large block of greensand and a few small flints. Above this was a tip of winkle shells (layer 62). The upper part of the pit was filled with tips of black occupation rubbish (layers 56, 31 and 34) interspersed with lenses of clay, winkle shells (layer 31a) and flints and stone. They appeared to represent a deliberate act of filling over a short period of time using any available rubbish.

Pottery (fig. 84, nos. 120-5; pp. 151, 153)

Developed medieval tradition: thirteenth-century.

Small Finds

From layer 56:

Roman bronze coin (1173): Constantine II (A.D. 330-45)

Animal Bones

124 fragments identified (including 24 ribs and 3 skull fragments).

Species represented: cattle 40, sheep 30, pig 20, red deer 4, horse 3, roe deer 2, bird 1.

Pit 132

The bottom of the pit was covered with a closely packed mass of partly burnt chalk rubble, no fragment exceeding 3 in. (0.08 m.) across (layer 70). Above this was a layer of brown soil intermixed with wads of brickearth, combe rock, baked clay and charcoal, giving the appearance of having been thrown into the pit in shovelfuls (layer 61). This was sealed

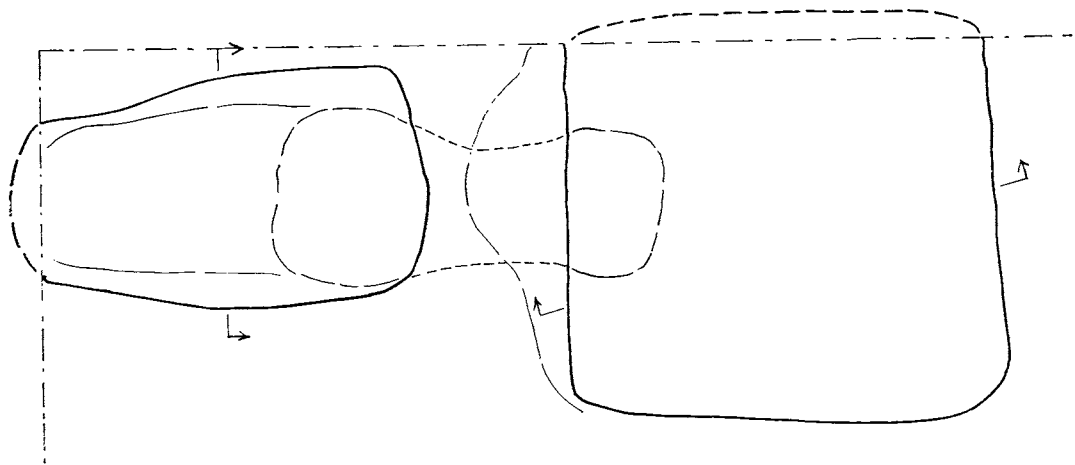
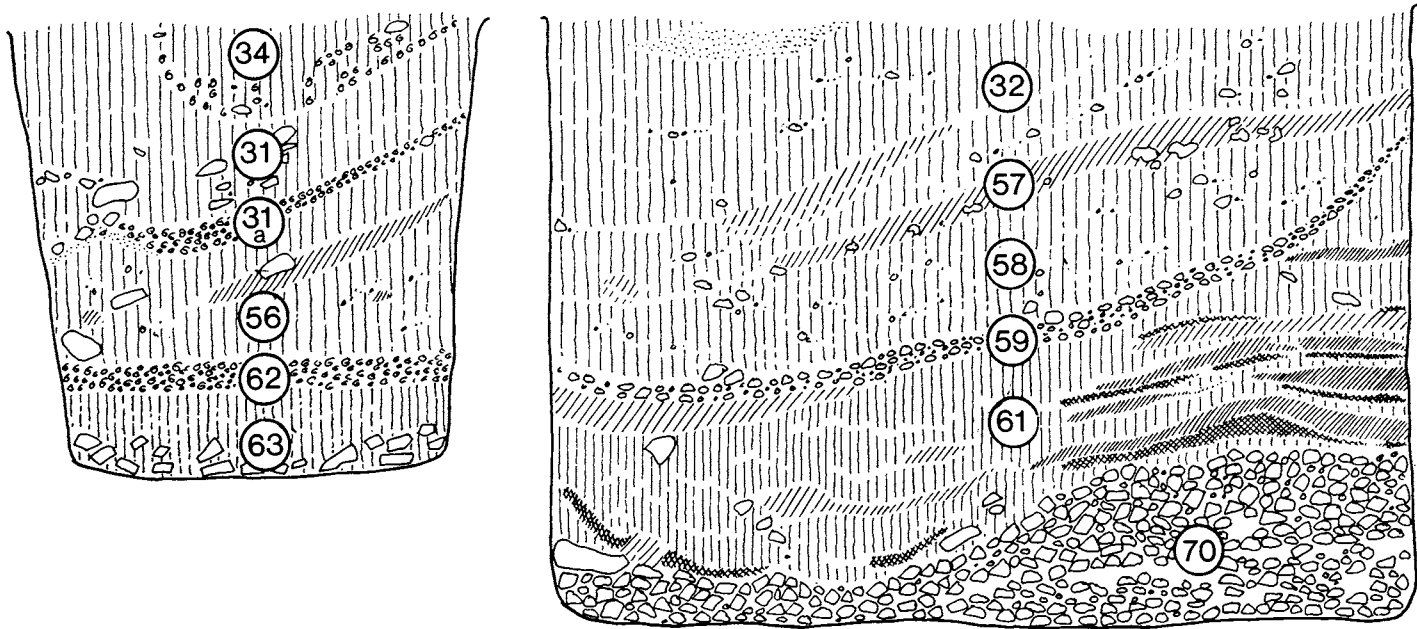

ONE METRE

THREE FEET

SECTIONS

TWO METRES

SIX FEET

PLANS

FIG. 50. Pits 131 and 132

by a layer of finely crushed chalk (layer 59). The upper filling of the pit consisted of grey-brown soil mixed with stones and occupation rubbish (layers 58 and 32) interleaved with lenses of brickearth (e.g. layer 57).

Pottery (fig. 85, nos. 126-43; pp. 153-5)

Developed medieval tradition: thirteenth-century.

Small Finds

From layer 32:

Iron spur (1309): fig. 104, no. 14

From layer 57:

Roman bronze coin (1311): Valentinian I (A.D. 364-75)

From layer 58:

Iron shears (1317): fig. 106, no. 38

Iron knife (1318): fig. 107, no. 44

Iron fragment (1319): not illustrated

Iron horseshoe (1320): fig. 106, no. 37

From layer 59:

Iron fragment ?nail (1178): not illustrated

Iron chain (1179): fig. 109, no. 70

Animal Bones

188 fragments identified (including 50 ribs and 3 skull fragments).

Species represented: sheep 39, cattle 36, pig 14, bird 2, fish 2, horse 2, red deer 1, roe deer 1, dog 1.

Pit 146 (PC 70, trench 95, layers 103, 112, 114-19)

Approximately circular pit 4 ft. 8 in. (1.42 m.) in diameter cut to a depth of 3 ft. 6 in. (1.07 m.) below the surface of the natural brickearth.

The lowest layer (layer 119) consisted of grey soil mixed with charcoal, and was partially sealed by brickearth (layer 118) which had eroded in from the sides of the pit. Above this was a filling of grey soil and occupation rubbish (layers 114 and 117) interspersed with a lens of chalky marl (layer 116). Towards the top of the pit was a sealing layer of brickearth mixed with soil (layer 112) which was covered by a further deposit of black soil (layer 103).

Pottery (p. 155)

Date uncertain: twelfth- or thirteenth-century.

Small Finds

From layer 116:

Roman bronze coin (1666): House of Valentinian (A.D. 364-78)

Animal Bones

22 fragments identified (including 1 rib and 1 skull fragment).

Species represented: cattle, pig, hare, roe deer, sheep.

EXCAVATIONS AT PORTCHESTER CASTLE

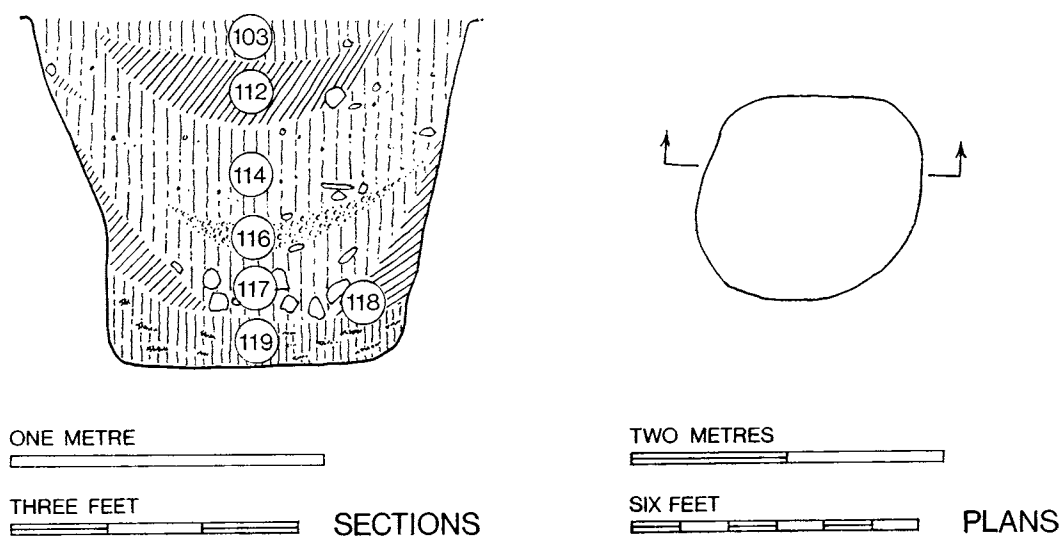

FIG. 51. Pit 146

Pit 152 (PC 70, trench 97, layers 14, 39, 53)

Pit (or well) of unknown size partially excavated at the western limit of the excavation. The lowest of the exposed layers (layer 39) consisted of black soil lying against the pit side. In the hollow above a layer of fine chalk marl had been thrown (layer 53). The upper part of the pit was filled with an accumulation of brown soil, partly derived from the erosion of the pit sides, intermixed with occupation rubbish including tips of winkle and oyster shells.

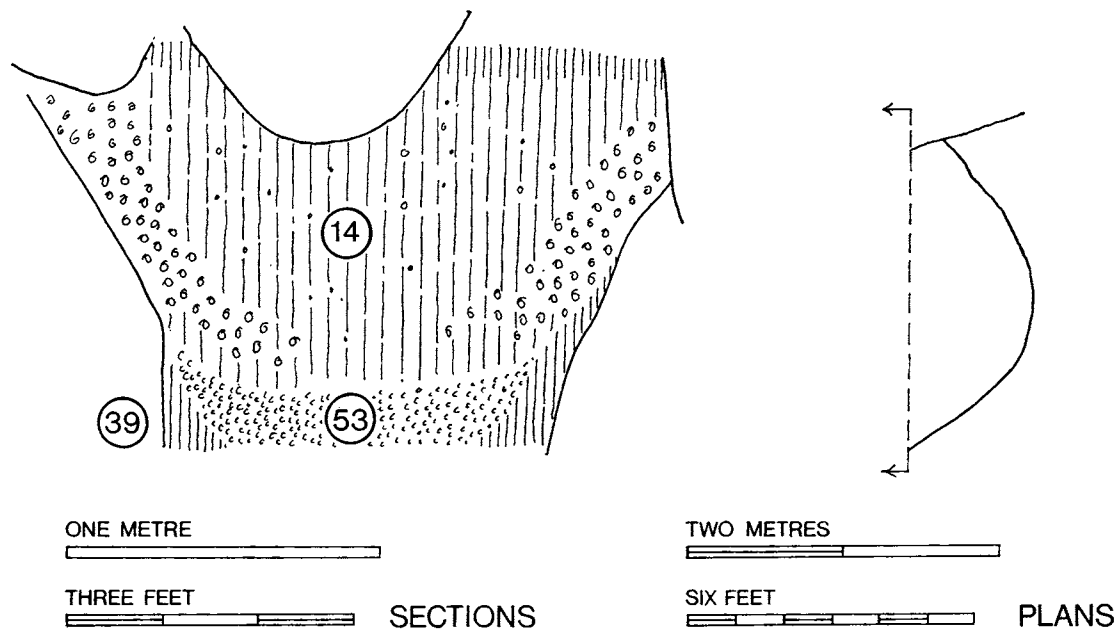

FIG. 52. Pit 152

Pottery (p. 155)

Date uncertain but of the early medieval or developed medieval tradition: twelfth- or thirteenth-century.

Pit 161 (PC 70, trench 97, layers 43-7)

Pit of approximately circular plan *c.* 5 ft. (1.52 m.) in diameter, cut to a depth of 5 ft. (1.52 m.) below the surface of the natural brickearth. The sides sloped in evenly to a narrow flat bottom.

The lowest layer (layer 47) was composed of a crumbly greenish brown cesspit filling which had rotted down causing the slumping of the layers above which consisted of tips of

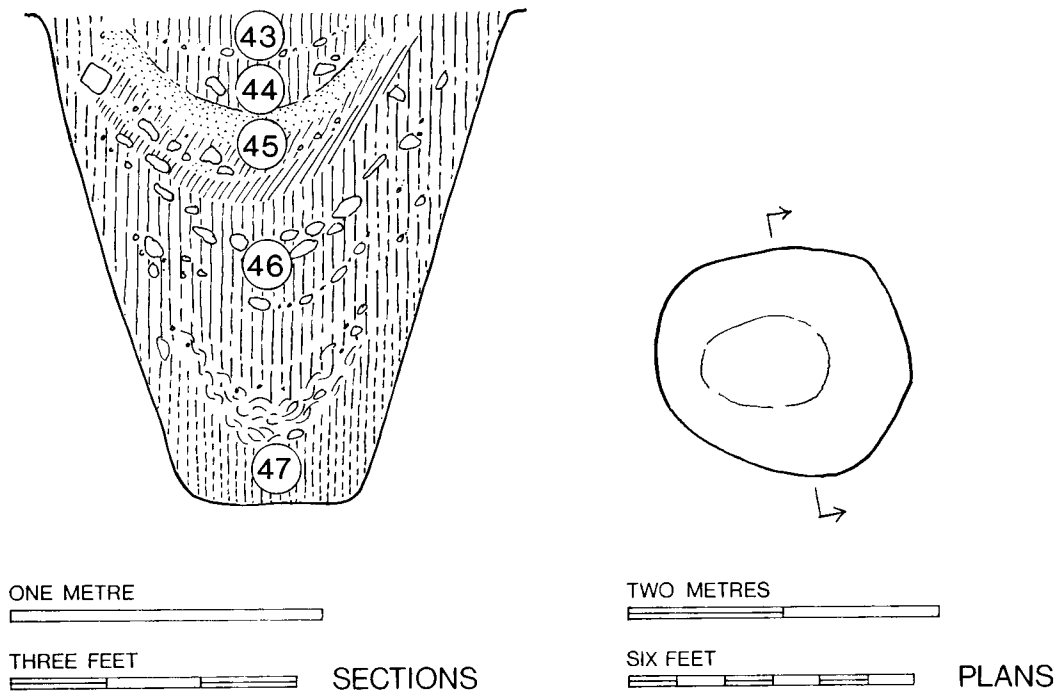

FIG. 53. Pit 161

occupation rubbish such as oyster shells interleaved with brown stony soil (layer 46). This was sealed with a layer of brickearth and chalk marl (layer 45). In the hollow above brown stony soil had accumulated (layers 44 and 43).

Pottery (fig. 86, nos. 144-5; pp. 155, 156)

Early medieval tradition: thirteenth-century.

Animal Bones

34 fragments identified (including 1 rib and 2 skull fragments).
Species represented: cattle, bird, sheep, fallow deer, red deer.

Pit 172 (PC 70, trench 99, layer 47)

Pit of unknown size largely cut away by the foundations of the sixteenth-century storehouse. Cut to a depth of 1 ft. 9 in. (0.53 m.) below the surface of the natural brickearth.

The filling (layer 47) consisted of brown stony soil containing occupation rubbish and lenses of brickearth.

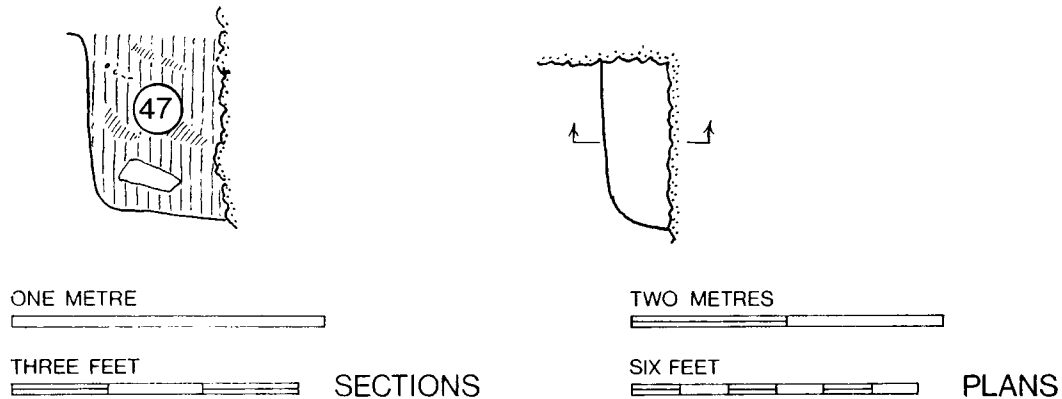

FIG. 54. Pit 172

Pottery (fig. 86, no. 146; pp. 155, 156)

Date uncertain: twelfth- or thirteenth-century?

Animal Bones

3 fragments identified.

Species represented: cattle, sheep.

Pit 189 (PC 70, trench 98, layer 45)

Base of a small rectangular pit truncated by gully 16 and partially cut away by the footing of the sixteenth-century store building.

The filling (layer 45) consisted of brown soil which contained occupation debris including winkle shells.

Pottery (p. 155)

Two sherds of cooking pots in gritty fabrics. Eleventh- or twelfth-century.

Small Finds

Iron point (1939): fig. 109, no. 64

Animal Bones

2 fragments identified.

Species represented: cattle.

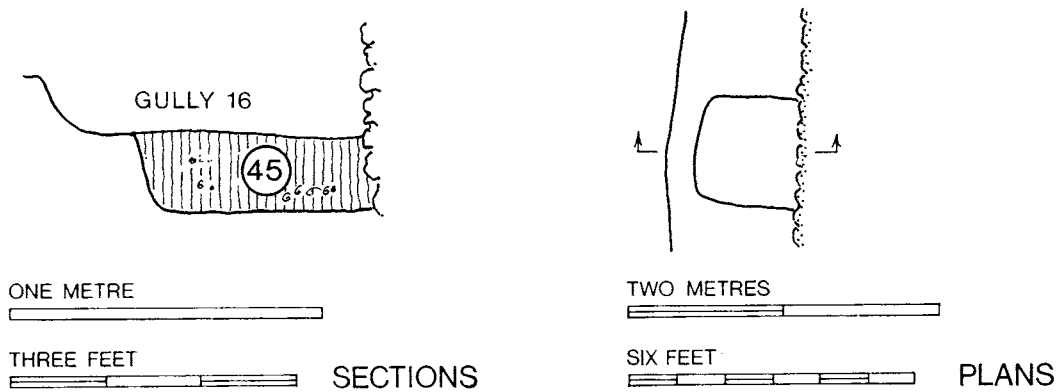

FIG. 55. Pit 189

Pit 190 (PC 71, trench 102, layers 39-41)

Circular pit *c.* 6 ft. 6 in. (1.98 m.) in diameter, cut to a depth of 3 ft. (0.91 m.) below the contemporary ground surface.

The main filling of the pit (layers 40a and 40b) was composed of brown soil containing lenses of brickearth eroded in from the sides and a number of large flints. Layer 39 was a thick lens of washed-in brickearth which divided layer 40a from 40b. The upper part of the pit was filled with a deliberate packing of brickearth and brown soil (layer 39).

Pottery (fig. 86, no. 147; pp. 155-6)

Developed medieval tradition: thirteenth-century.

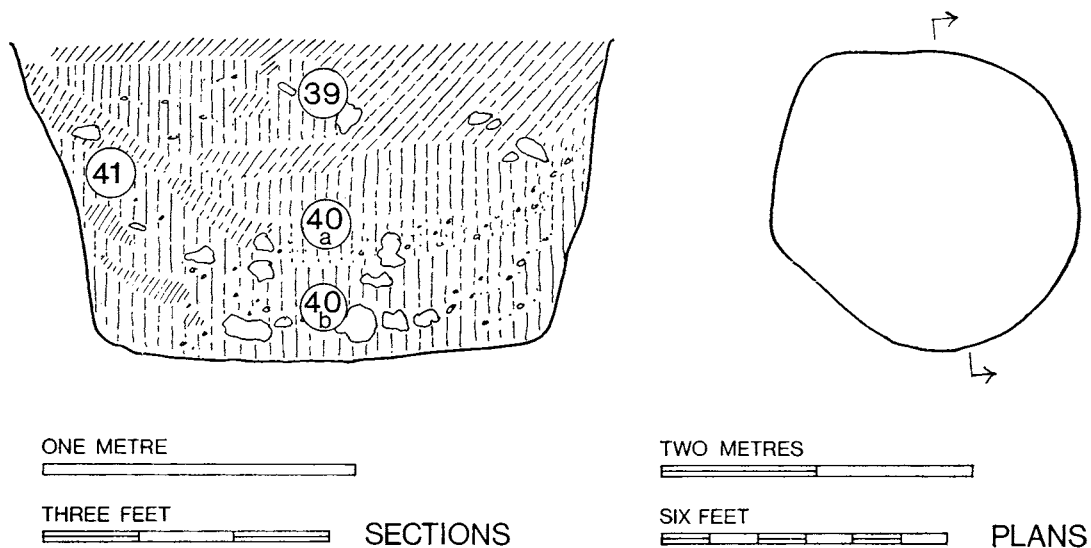

FIG. 56. Pit 190

Small Finds

From layer 40:

Five bronze fragments (2092): not illustrated

From layer 41:

Lead blob (2091): not illustrated

Animal Bones

44 fragments identified (including 7 ribs and 3 skull fragments).

Species represented: cattle, pig, sheep, bird, horse.

Pit 197 (PC 71, trench 101, layers 52-5)

Small oval pit 3 ft. by 3 ft. 10 in. (0.91 × 1.17 m.), cut to a depth of 1 ft. 10 in. (0.56 m.) below the contemporary ground surface.

Layer 55 represented the first erosion of the pit side deposits, a washed-in layer of chalky marl. Above this (layer 54) was a mass of crumbly mortar with a lens of clay above. This was sealed by a lens of ash and charcoal (layer 53). The upper fill (layer 52) consisted of black soil mixed with occupation debris.

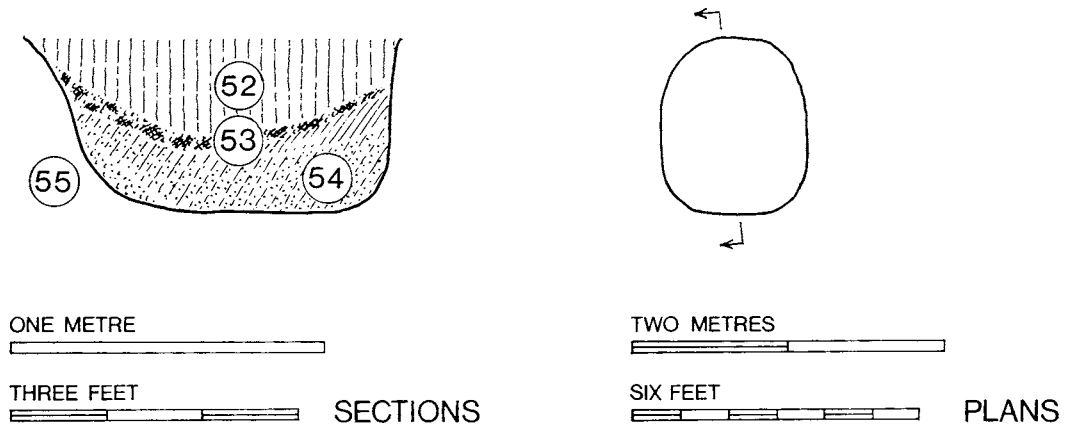

FIG. 57. Pit 197

Pottery (p. 156)

Few sherds, date uncertain, but twelfth- or thirteenth-century.

Small Finds

From layer 52:

Roman bronze fibula (2191): fragment only

Bronze scrap (2192): not illustrated

Iron knife (2193): fig. 107, no. 46

Whetstone (2194): fig. 111, no. 88

Animal Bones

22 fragments identified (including 5 ribs).

Species represented: cattle, pig, sheep, roe deer.

Pit 199 (PC 71, trench 101, layers 64, 65)

Rectangular pit 3 ft. by 3 ft. 7 in. (0.91 × 1.09 m.) with sloping sides cut to a depth of 2 ft. 3 in. (0.69 m.) below the contemporary ground surface.

The filling consisted of brown soil with large flints and some occupation debris (layer 65) with a thick layer of charcoal towards the bottom (layer 64).

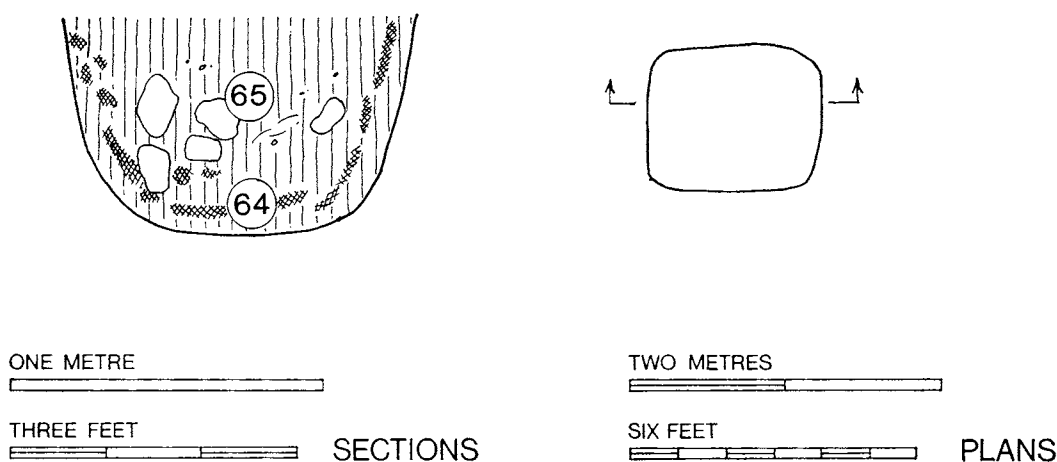

FIG. 58. Pit 199

Pottery (fig. 86, no. 148; p. 156)

Date uncertain, but of the Saxo-Norman or early medieval tradition.

Animal Bones

16 fragments identified (including 4 ribs).

Species represented: cattle, pig, bird.

Pit 208 (PC 71, trench 103, layer 37)

Roughly oval-shaped pit up to 5 ft. (1.52 m.) across, cut to a depth of *c.* 1 ft. (0.30 m.) below the contemporary ground surface.

The uniform filling consisted of brown soil, mixed with large flints and mortar.

Pottery (fig. 86, nos. 149, 150; p. 156)

Developed medieval tradition: thirteenth-century.

Small Finds

Worked stone (2262): not illustrated

EXCAVATIONS AT PORTCHESTER CASTLE

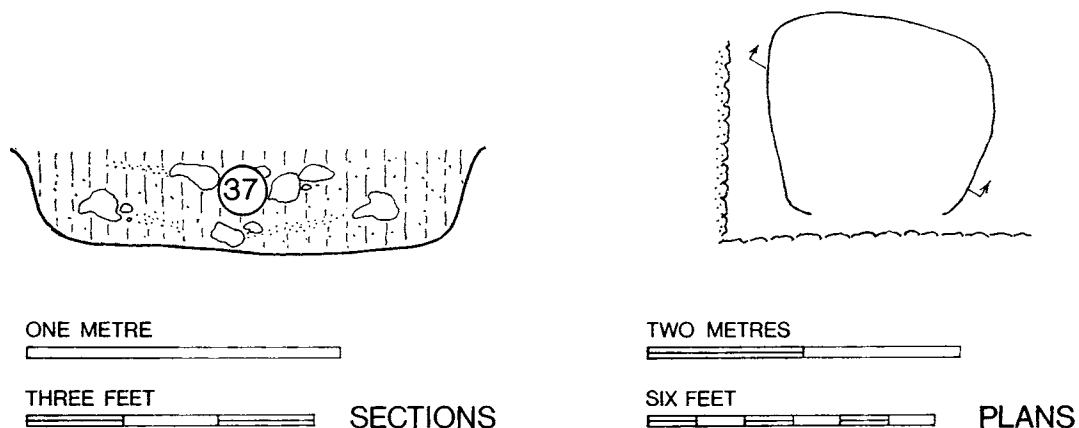

FIG. 59. Pit 208

Pit 214 (PC 72, trench 108, layers 13, 23, 27-9)

Rectangular pit 3 ft. 6 in. by 5 ft. (1.07 × 1.52 m.) cut to a depth of 4 ft. 9 in. (1.45 m.) below the contemporary ground surface.

The lowest fill (layer 29) consisted of crumbly green-brown cesspit filling, above which was a lens of charcoal (layer 28) and a sealing layer of crumbly, chalky mortar (layer 27). The upper part of the pit was filled with tips of brown soil interleaved with lenses of clay, stones

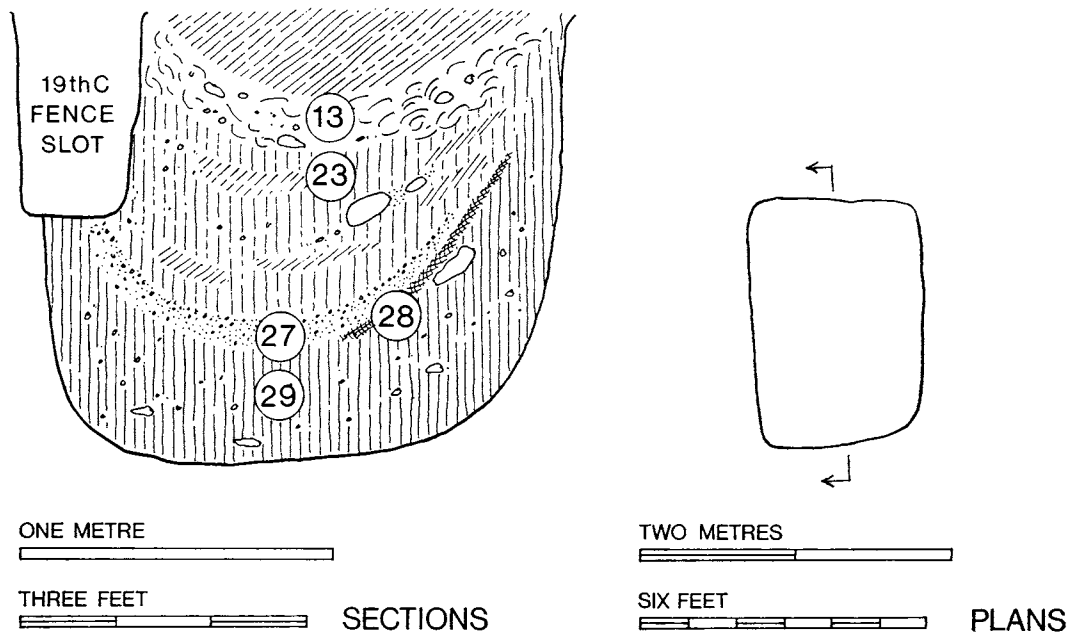

FIG. 60. Pit 214

(layer 23) and oyster shells (layer 13). Above this a layer of brown clayey soil, continuous across this part of the site, had slumped in.

The pit was cut by a nineteenth-century fence slot.

Pottery (fig. 87, nos. 152–60; pp. 156–8)

Developed medieval tradition: thirteenth-century.

Small Finds

From layer 13:

Iron fragment (2422): not illustrated

From layer 23:

Iron hook or hinge (2428): fig. 109, no. 69

Lead cuttings (2427): not illustrated

Animal Bones

109 fragments identified (including 43 ribs and 2 skull fragments).

Species represented: sheep 34, bird 25, cattle 22, pig 17, fish 2.

Pit 215 (PC 72, trench 107, layer 27)

Pit 4 ft. (1.22 m.) wide and of uncertain length since its ends were cut away by pits 212 and 213. Cut to a depth of 3 ft. 6 in. (1.07 m.) below the contemporary ground surface.

The uniform filling consisted of brown soil with large flints and some lumps of mortar.

Pottery (fig. 87, nos. 161–5; pp. 157, 158)

Developed medieval tradition: thirteenth-century.

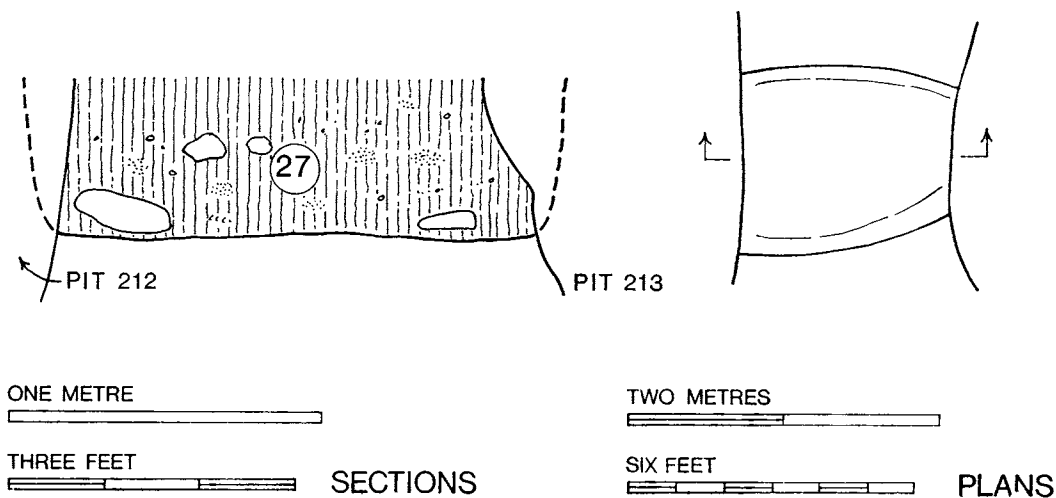

FIG. 61. Pit 215

Small Finds

Iron door fitting? (2401): fig. 108, no. 58

Animal Bones

70 fragments identified (including 19 ribs and 3 skull fragments).

Species represented: sheep 40, cattle 29, bird 17, pig 10, mouse 4.

Pit 232 (PC 72, trench 109, layer 20)

Square pit 3 ft. 3 in. (0.99 m.) across, cut to a depth of 1 ft. 9 in. (0.53 m.) below the surface of the natural brickearth.

The uniform filling consisted of brown stony soil with some occupation rubbish.

Pottery (p. 158)

Date uncertain, but twelfth- or thirteenth-century.

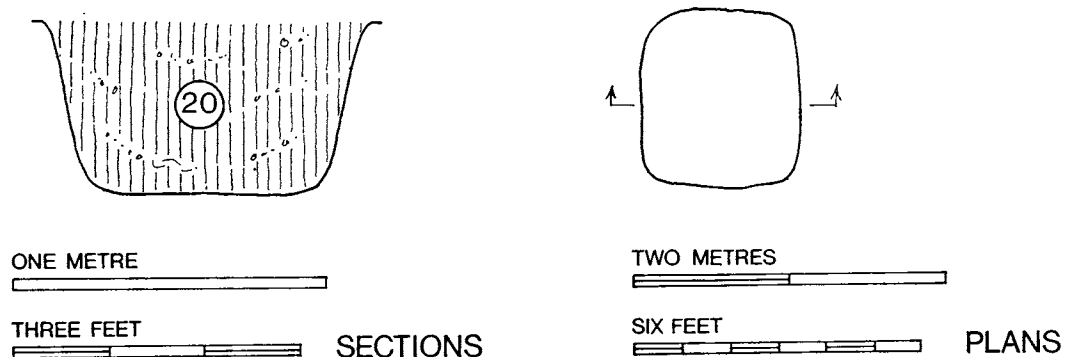

FIG. 62. Pit 232

Pit 233 (PC 72, trench 109, layer 54)

Square pit 5 ft. (1.52 m.) across at the top, but with one side eroded out to form a sloping ramp. Cut to a maximum depth of 3 ft. 3 in. (0.99 m.) below the surface of the natural brickearth.

The filling consisted of tips of chalky marl, clay and black soil thrown in apparently in one operation.

Pottery (p. 158)

Date uncertain but of the Saxo-Norman or early medieval tradition: eleventh- to twelfth-century.

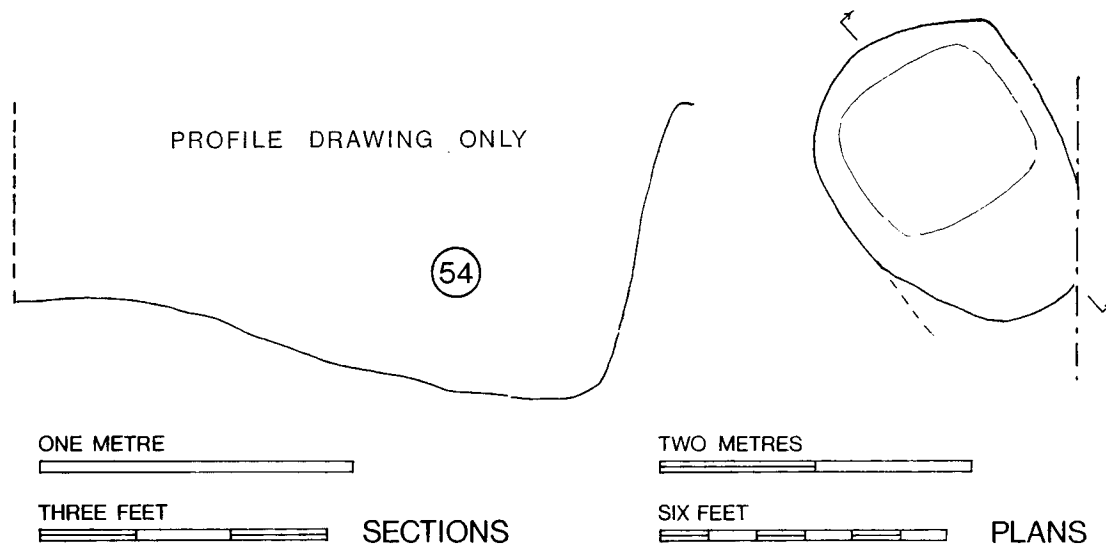

FIG. 63. Pit 233

Small Finds

Roman silver coin (2574): Magnus Maximus (A.D. 383-8)

Animal Bones

7 fragments identified (including 2 ribs).
Species represented: cattle, sheep.

GENERAL BIBLIOGRAPHY

- BROWN, R. A., COLVIN, H. M. and TAYLOR, A. J. 1963. *The History of the King's Works. II: The Middle Ages.* (London).
- CRAWFORD, O. G. S. 1938. 'Crop-mark at Portchester Castle.' *Antiquity* xii (Dec.), 478-9.
- CUNLIFFE, B. W. 1963. 'Excavations at Portchester Castle, Hants, 1961-3. First Interim Report.' *Antiq. J.* xliii, 218-27.
- CUNLIFFE, B. W. 1966. 'Excavations at Portchester Castle, Hants, 1963-5. Second Interim Report.' *Antiq. J.* xlvi, 39-40.
- CUNLIFFE, B. W. 1969. 'Excavations at Portchester Castle, Hants, 1966-8. Third Interim Report.' *Antiq. J.* xlix, 62-74.
- CUNLIFFE, B. W. 1970. 'The Saxon culture-sequence at Portchester Castle.' *Antiq. J.* l, 67-85.
- CUNLIFFE, B. W. 1971. 'The Tudor Store-House at Portchester Castle, Hants.' *Post-Med. Arch.* v, 188-90.
- CUNLIFFE, B. W. 1972. 'Excavations at Portchester Castle, Hants, 1969-71. Fourth Interim Report.' *Antiq. J.* lii, 70-83.
- CUNLIFFE, B. W. 1975. *Excavations at Portchester Castle, Volume I: Roman.* (London: Society of Antiquaries Research Reports, No. XXXII).

- CUNLIFFE, B. W. 1976. *Excavations at Portchester Castle. Volume II: Saxon.* (London: Society of Antiquaries Research Reports, No. XXXIII).
- PLATT, C. and COLEMAN-SMITH, R. 1975. *Excavations in Medieval Southampton 1953-1969*, Vols. 1 and 2 (Leicester).
- RADFORD, C. A. R. 1970. 'The later pre-Conquest boroughs and their defences.' *Med. Arch.* xiv, 83-103.
- RIGOLD, S. E. 1965. *Portchester Castle, Hampshire*, 3rd. edn. (H.M.S.O.).
- SINGER, C. 1967. *A History of Technology*. Volume ii (Oxford).
- WILLIAMS-FREEMAN, J. P. 1915. *Field Archaeology as Illustrated by Hampshire* (London).

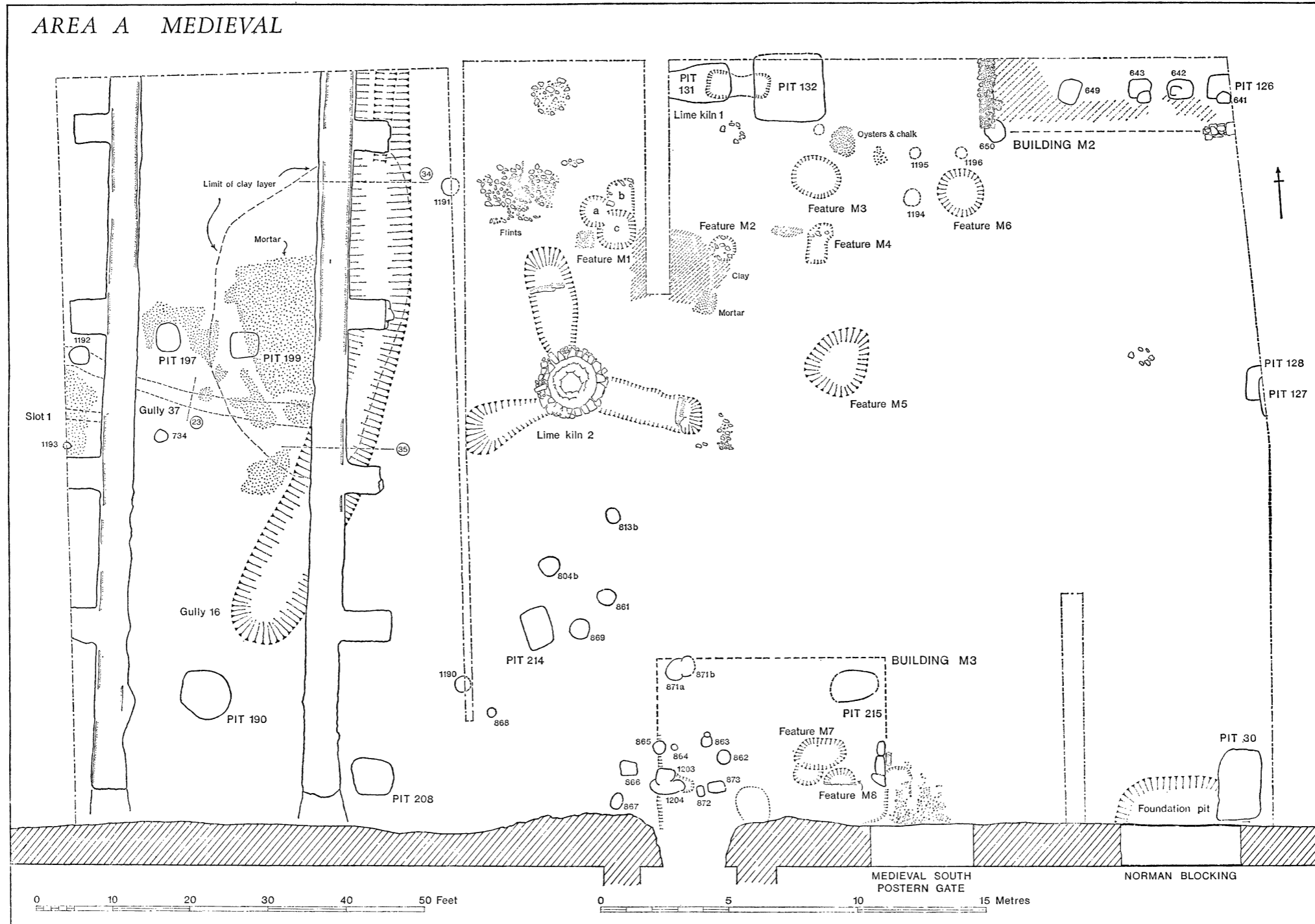

FIG. 64. Area A showing all medieval features



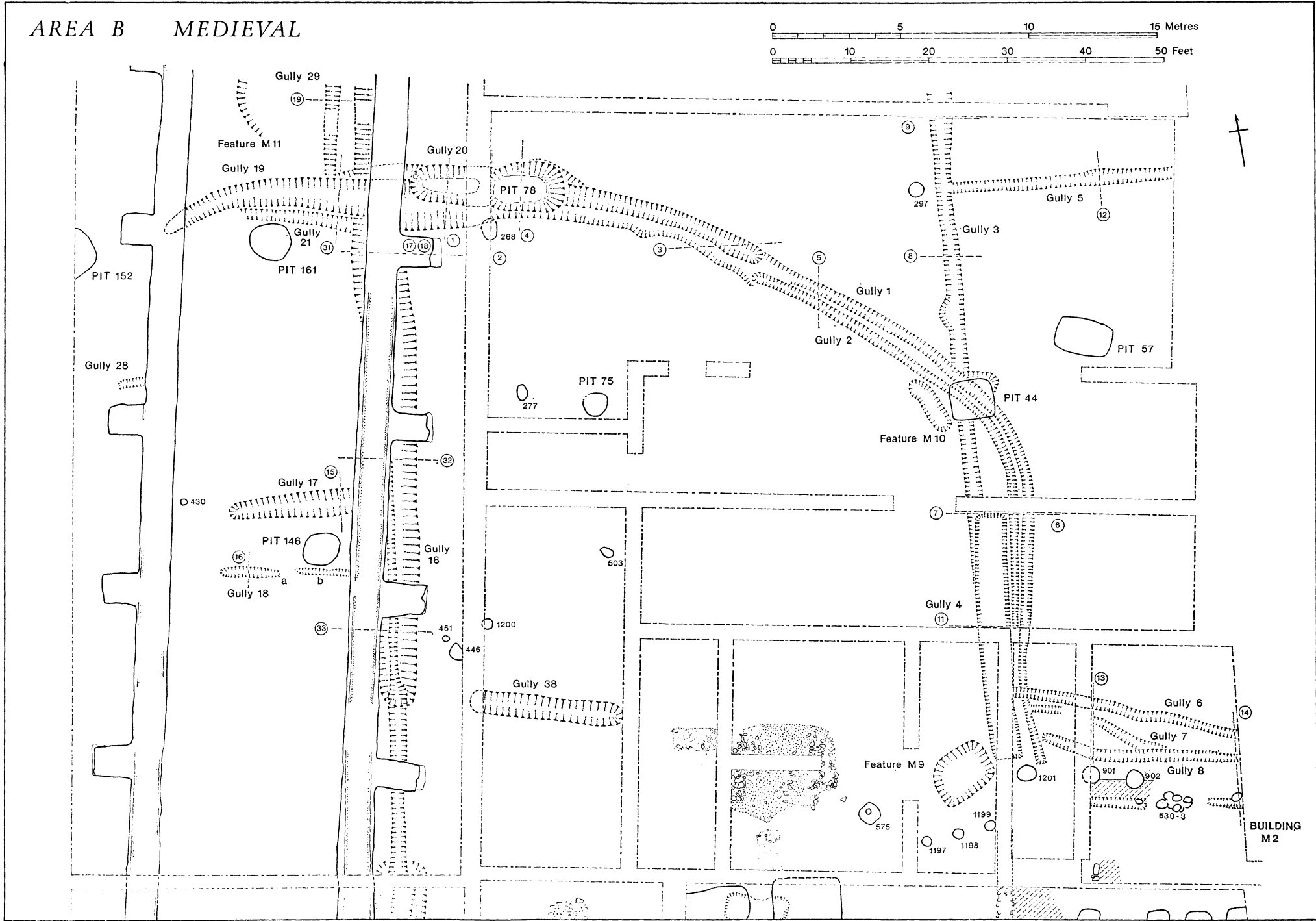

FIG. 65. Area B showing all medieval features

AREA C MEDIEVAL

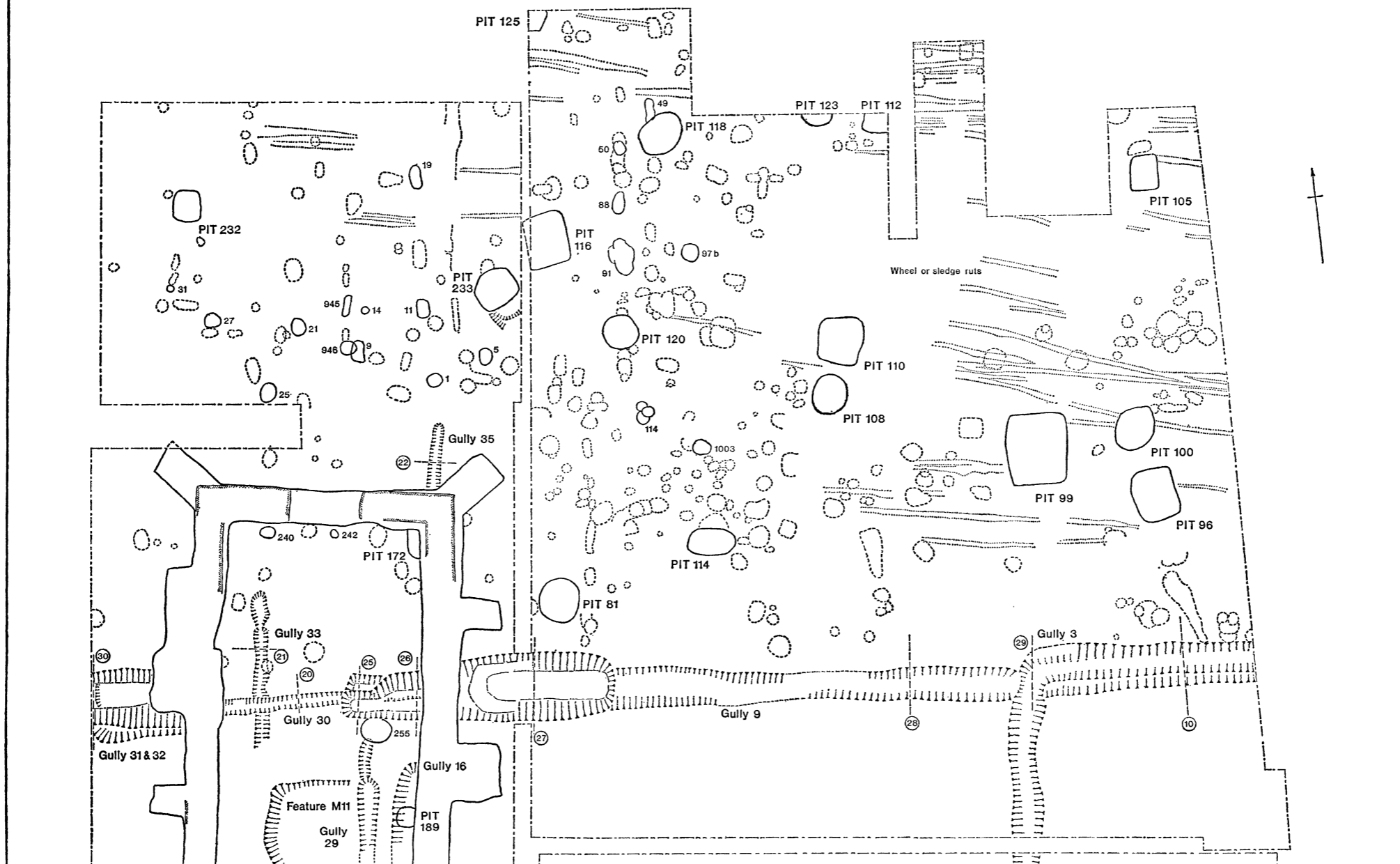
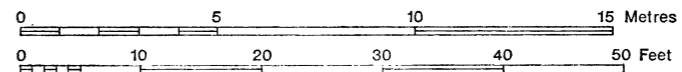

FIG. 66. Area C showing all medieval features. Features delimited in a broken line are of uncertain date but may be medieval

IV. THE OUTER BAILEY—THE SITE OF THE PRIORY

THE EXCAVATIONS

By DAVID BAKER

Introduction

THE parish church of St Mary, formerly the Augustinian priory church, lies with its graveyard within the south-east quadrant of the medieval castle outer bailey (fig. 67). Intensive burying in the entire churchyard has left only a small part accessible for excavation, and must have destroyed most archaeological evidence. Only two strips were investigated, the pathway around the church, narrowed by the insertion of a modern concrete plinth against the church, and the ground close to the fort wall, south and east of the church.

A resistivity survey was carried out across the claustral area, now the centre of the oldest part of the graveyard, but without any clear results, due to the disturbance of grave digging. A vestry was recently built overlapping the site of the west range against the church, but unfortunately there was no opportunity to make an archaeological examination of its footing trenches.

I am grateful to the then Rector of Portchester, the Rev. C. F. Cardale, M.A., for readily granting permission to excavate, and to the Churchwarden, Captain J. Grindle, R.N. (retd.), for interested and friendly co-operation. The excavations were carried out mostly in 1968–70. They formed part of a training course organized by the Department of Extra-Mural Studies in the University of Southampton during the summer of 1969. Portsmouth Polytechnic Archaeological Society assisted with most of the remaining work, and the final trenches were undertaken by a group from Bedford. Evelyn Baker assisted with direction and recording. Stuart Rigold made helpful suggestions regarding the interpretation of the west range. The whole excavation was conducted within the context of the Portchester research programme directed by Professor Barry Cunliffe, and greatly benefited from his observations and assistance.

The excavation of the priory quadrant was approached with three main archaeological problems in mind.

(a) Given the extent of Saxo-Norman use of the fort, was there any evidence in this quadrant for a parish church predating the priory church?

(b) How far and in what form was the priory constructed before the transfer of the canons to Southwick?

(c) When were the vanished parts demolished? Did they have any post-priory use, bearing in mind that the medieval castle persisted in the opposite quadrant for a further four centuries, with the remainder of the fort as its outer bailey?

The East End of the Church (trenches P₁, P₄)
(fig. 68)

At some time before the death of the Constable, Sir Thomas Cornwallis, in 1618 a blocking wall had been inserted at the present east end of the church. The superstructural evidence for the sequence here was confused by the re-use of ashlar blocks at this time and in later restoration work. None the less the primary priory church work is clearly indicated by a small plinth just above present ground level, not hidden by the modern restoration plinth. This Norman plinth is present on main walls and buttresses, both of clasping and pilaster type, and is usually absent where doors, later walls and other features have been introduced. At the south-east corner of the church it runs around the corner northwards sufficiently far to indicate a clasping corner buttress rather than a pilaster on a wall continuing further east. At the north-east corner of the church the plinth is more mutilated, but one block survives on the eastern face to show a similar depth of return.

Trenches P₁ and P₄ were excavated to seek evidence for a reconstruction of the eastern termination which had been replaced by this blocking wall. Initially it was felt that the task was to decide whether a missing bay gave a square or an apsidal end.

In trench P₁ the wall footing for the demolished east end was seen with a width of 4 ft. (1.22 m.), but in a robbed and disturbed condition (pl. XXIV*b*). It was made of rough limestone blocks set in a white mortar. Its core had been completely destroyed by a burial cut through it to a maximum depth of only 1 ft. 7 in. (0.48 m.) below the path surface. The skull of this skeleton had been removed by an extension of the construction trench for the modern restoration plinth. The footing ran generally eastwards, but its edges were insufficiently defined to show any definite alignment.

No floor levels were seen north of this footing, but several disturbances likely to have been graves were not investigated. One of these, north of the footing, had two rows of brass buttons on its surface; it may have related to a re-sited eighteenth-century tombstone immediately to the east, probably moved to this secondary position from against the church when the modern plinth was inserted.

Trench P₄ was similarly uninformative. A footing of flint and white-cream mortar, about 4 ft. 6 in. (1.37 m.) wide, was seen in a length of nearly 2 ft. (0.61 m.). It had been cut by the modern plinth insertion and to the east by various graves of undetermined date. The ground was much more disturbed in the trench and little stratigraphy survived.

The evidence of surviving superstructure and excavated remains allows at least four interpretations to be considered. First, an apse may have been built with the priory church, and removed by about 1618. This is consistent with clasping buttresses on the existing corners, having the apse springing from their internal angles. However, no evidence for an apse foundation was seen in the north of trench P₁ or the south of P₄; also, at the north-east corner of the church, the Norman plinth had been cut to give a width similar to that of the excavated footing further east. Secondly, the church may have originally had a square-ended termination on an extra bay. This explanation is consistent with the evidence of eastward continuing footings, but not with that of the surviving walls, if the evidence for corner clasping buttresses is accepted. The third possibility is that an original square-ended termination on an extra bay was replaced at some time in the medieval period, and the replace-

PORTCHESTER CASTLE

AUGUSTINIAN PRIORY AND CHURCH OF ST. MARY

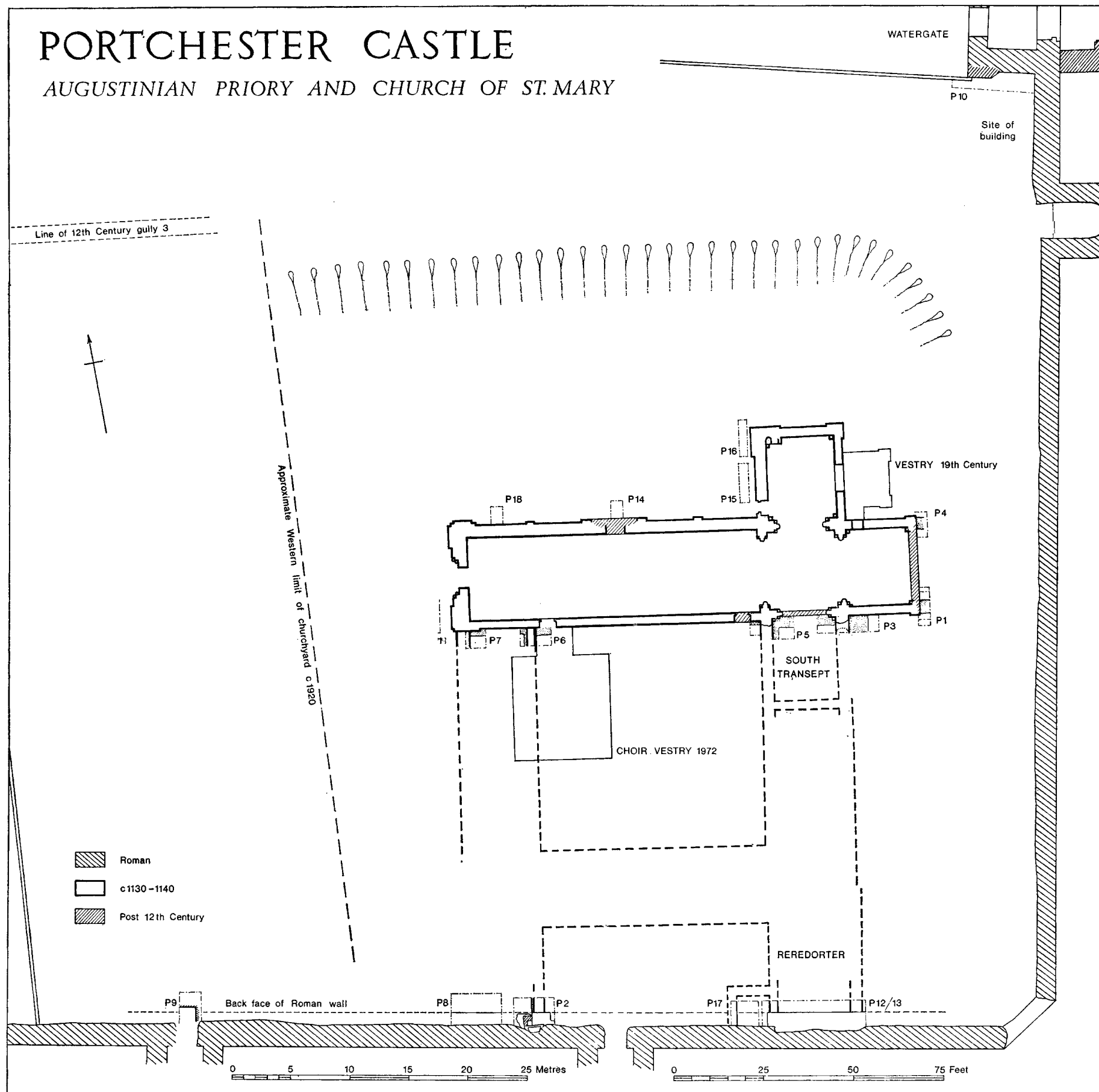

FIG. 67

ment was removed by the early seventeenth century. Like the second possibility, this fails if weight is given to the evidence of primary corner clasping buttresses. Fourthly, the simplest explanation of the available evidence seems to be that the original church terminated in its present position with a square end, and that the excavated foundations represent a later, perhaps post-priory, addition which was removed by the early seventeenth century. This is supported by the impression of an unfinished structure which Alan Borg has noted within the chancel. It accounts for all the known facts and is not in direct conflict with any of them. Other possibilities, such as the original provision of footings for a two bay square east end, only built above ground as one bay, should not be ignored, but there is insufficient evidence to assess them properly. However, it is still prudent to end on a note of caution, re-emphasizing the amount of disturbance caused here by grave-digging and church restoration.

The North and West Sides of the Church
(trenches P11, P14, P15, P16, P18)
(fig. 69)

Five trenches were excavated north and west of the church, along the paths adjacent to the standing building, to see whether there was any evidence for earlier churches not exactly on the same site. The site of the Norman north transept chapel was obscured by its nineteenth-century successor and oil tanks. The transept chapel, adequate traces of whose existence can be seen in the Norman north transept, had been removed and not yet replaced in 1815 according to a detailed plan of the whole castle.¹ The north-eastern buttress, clasping round the corner, may suggest an apsidal termination.

Trench P11 was set out south of the west entrance of the church, 3 ft. (0.91 m.) from the main flanking buttress. The ground level at this point had been reduced. Recent path metalling covered layers probably contemporary with or pre-dating the church, since no construction spread was seen. The only features were burials, probably laid out respecting the church.

Trench P14 was set out against the large central shallow buttress on the north side of the nave. It could only be excavated for 5 ft. (1.52 m.) out from the church. A feature of loose yellow mortar with flints and pebbles ran into the trench from the east, but was cut by the modern restoration plinth to the south and by probable graves to the north. No dating material was found, and no conclusions are drawn from this limited evidence.

Trench P15, to the west of the north transept, was excavated to a maximum depth of 2 ft. 2 in. (0.66 m.) below the present ground surface. The disturbed nature of the ground, attributed to unmarked graves, inhibited deeper investigation.

Trench P16 was excavated immediately to the north of trench P15. It showed a similar picture of ground disturbance by burials. The trench was then extended eastwards at its south end for a length of 2 ft. (0.6 m.) in order to see the Norman church footings, since there was no sign here of the modern restoration plinth. The lowest ashlar course was that seen going into the ground. At least five courses of unshaped stones were seen beneath it, with fairly

¹ Hants CRO 4 M 53. Lease from Thomas Thistlethwayte to H.M. Commissioners for Barracks, 31st May 1815.

coarse sandy yellow mortar between them. No construction trench was visible, and the disturbed layer in the trench ran right up to the church.

Trench P18 was excavated against the north wall of the nave. Again the ground was generally disturbed by burials, and the modern restoration plinth had obliterated the area immediately adjacent to the church footings.

The South Transept and the Eastern Range
(trenches P3, P5, P12, P13, P17)
(fig. 68)

Two trenches were excavated against the truncated side of the south transept (pl. XXXIV). For reasons of safety these were positioned separately against the south side of the south-west (trench P5) and south-east (trench P3) crossing piers, rather than in one continuous trench across the whole transept. In the event only a strip of 6 ft. 6 in. (1.98 m.) between the two piers was not examined. The two trenches are described together.

Post-medieval and modern disturbances had reduced the amount of available evidence. Outside each crossing pier was a roof down-pipe to a drain running across the trenches. In trench P3, a vault and a grave had cut through the eastern transept footing: a further grave had been cut within the transept itself. In trench P5, a grave had also been cut through the west transept footing. The modern restoration plinth had disturbed the ground against the church outside the two main transept walls.

These trenches showed that the church at this point was based upon broad strip footings tying the plan together, in places functioning as sleeper walls. The four crossing piers rose from the four corners of a square footing. The southern sleeper wall of this square became a true foundation when the blocking wall between the two southern piers was inserted after the demolition of the transept. The east and west walls of the south transept were bonded with the southern part of the crossing sleeper wall, suggesting a single period of construction. For both southern crossing piers, large rough blocks had been laid in two to three courses, interspersed with small flints to provide a footing. There was a slight distinction between a white, pebbly mortar used in the footings immediately underneath the pier, and a yellower, sandier, finer grained mortar used for the other footings. Together with the evidence from trench P18, this might suggest that the footings for the church were laid out entirely in one campaign, before major superstructural construction commenced.

The blocking wall across the north of the south transept was made of ashlar, no doubt re-used from the demolished parts of the church (pl. XXXIV). Its coursing was distinctively random as opposed to the more regular medieval work. At the base, it rode up over the chamfered offsets of the Norman pier bases.

These two trenches showed, as might be expected, the position of the two southwards running walls of the south transept. The narrow width of the available section prevented any significant exploration into the transept, and certainly not as far as the north end of the eastern range. It can only be noted that the width of the transept and of the east range against the fort wall were similar.

Trenches P12 and P13 were excavated for a total length of 30 ft. (9.14 m.) running west-east against the fort wall. It was assumed that the garderobe slits indicated a reredorter

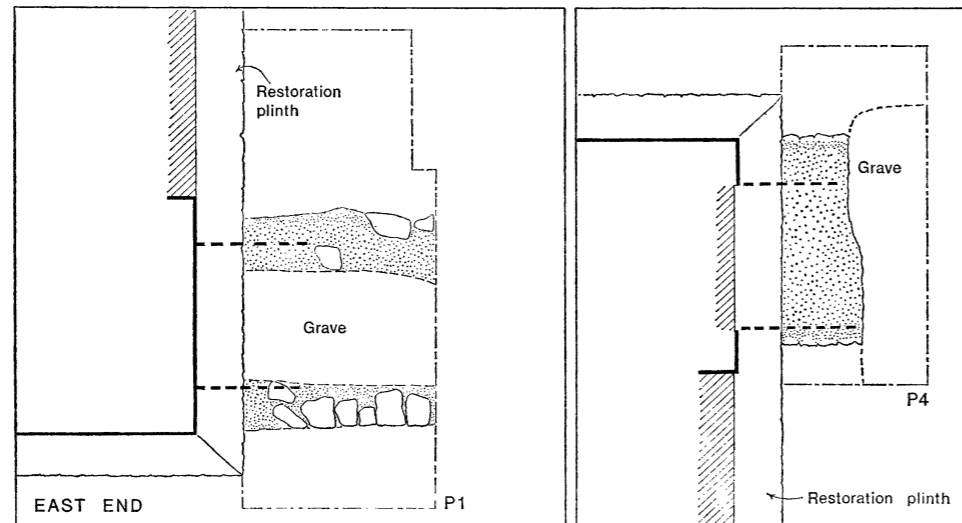
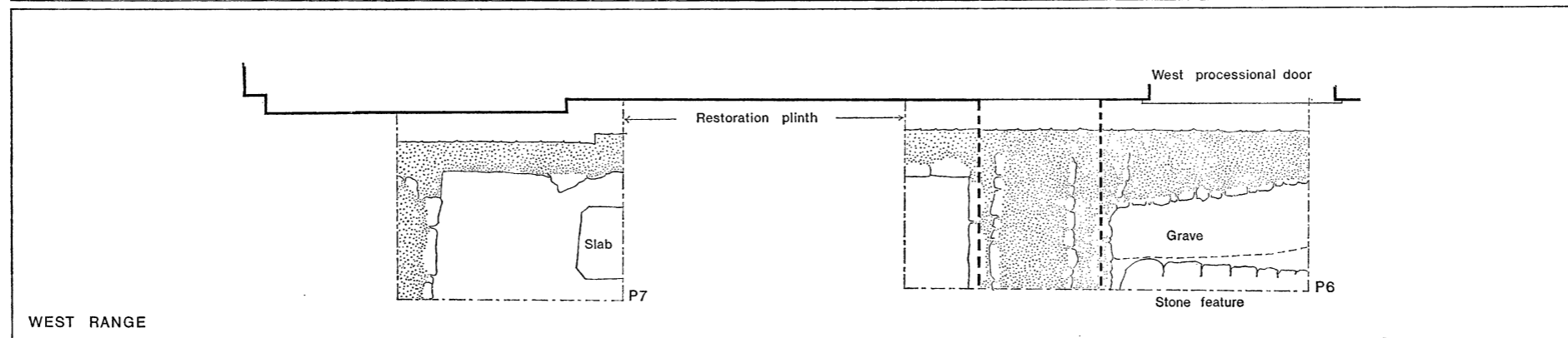
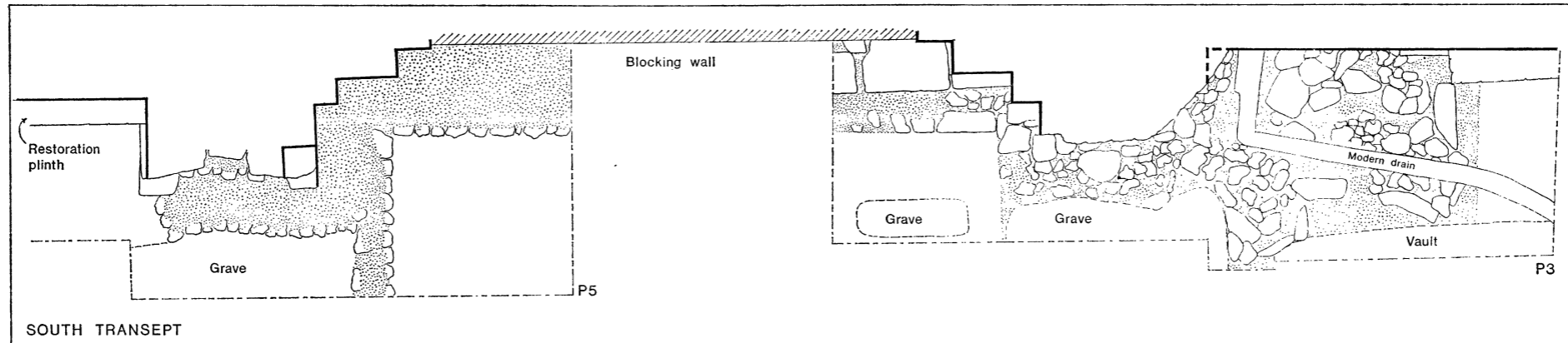

PORTCHESTER CASTLE
PRIORY

Trenches against the church

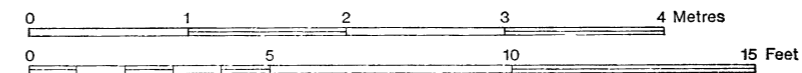

FIG. 68

in the usual position at the south end of a dormer range. These trenches could not be totally excavated to natural subsoil due to a considerable build-up of loose rubble against the fort wall, but surviving medieval layers were fully investigated.

Parts of the footings for both the western and eastern walls of the east range were seen. A footing survived on the east side, though the western was almost entirely robbed. Both abutted the original front face of the Roman fort wall, and had ridden up over the surface of the eroded portion to abut the upstanding refaced fort wall. A deliberate channelling into the Roman wall surface could be seen for the west wall and there was a lesser erosion on the east side, possibly the same feature. No occupation layers associated with the eastern range of the priory were located.

At the west end of trench P12, outside the robbed footing, and almost on a line with it, the original face of the Roman wall had been cut back severely during the life of the monastic range. Accordingly trench P17 was excavated immediately to the west of trench P12, giving a further extension westwards to total 39 ft. (11.89 m.).

Trenches P12 and P17 showed a building abutting the west side of the eastern range. The western side of the cut into the Roman wall had been faced with a fine mortar which almost resembled plaster. In the west side of the trench, some 8 ft. 9 in. (2.67 m.) away, ran the east side of a medieval wall, roughly constructed. The intervening space had been filled with debris and patches of mortar. Layer 16, towards the bottom of this feature, contained fourteenth-century pottery. A sloping roof line can be seen cut into the refaced fort wall, above the area of this lean-to building. This implies the monastic buildings continued in some use for perhaps two centuries after the canons had transferred to Southwick.

The garderobe chutes above these trenches had been cut through the fort wall (pl. XXVIa, b). The nine apertures formed a row, each lined with ashlar blocks and pointing sharply downwards towards the fort exterior. The lower openings of the chutes were flush with the outside face of the fort wall, and rested on a slight ridge running the length of the insertion. On the priory side the surviving openings were recessed deeply into the fort wall so that a considerable ledge was in front of them. At its southern end the dormitory must have been a two-storey building with floor joists perhaps resting on this ledge. A groove running up the wall face to the east of this ledge probably represented the attachment of a timber superstructure to the fort wall.

The West Range (trenches P2, P6, P7, P8)
(figs. 68, 69)

Trenches P6 and P7 were intended to investigate respectively the east and west walls of the west range where they abutted the nave of the church (pl. XXXV). In both trenches the modern restoration offset obliterated the exact relationship of the walls to the church.

The offset foundation for the south wall of the priory church seemed thicker here than seen elsewhere. It came out some 1 ft. 6 in. to 2 ft. (0.46–0.61 m.) from the upstanding ashlar face. Since the total width of the footing has not been ascertained, it is not clear whether this represents special superstructural needs at this point, or broad foundations with a non-central superstructural wall. Both west range footings were bonded into the footing for the south wall of the nave, and had the yellow sandy mortar used elsewhere in the church.

The eastern wall was located just to the west of the western processional door from the church into the cloisters. This had a porch, and was presumably still open in 1815.¹ The position for the eastern side of the west wall suggested that, unless the whole wall was unusually thick, the west side of the range would have been slightly recessed back from the line of the church west front.

The width between wall edges gave a west range at this point of internal width about 13 ft. 4 in. (4.06 m.). The evidence of the long corbel on the south side of the nave wall (pl. XXXV) suggests that the northern unit of the west range was a chamber with west-east axis having a barrel vault as at Norton Priory (Greene, 1972). This would have been an outer parlour providing access between the cloister and the outer bailey of the castle. It is not known how much further the western range extended to the south, if at all.

In trench P6, a stone feature was seen in the south-eastern corner of the trench. Even though it was separated from the church by a grave, both features were sealed by several layers, which also sealed the footing for the south wall of the nave. Although no dating evidence was available, on stratigraphic grounds this feature could be contemporary with or earlier than the priory. Yet an ecclesiastical context is not certain, since Roman and Saxon features seem to occur throughout the fort. In trench P7 a worked slab of stone of indeterminate date was found projecting from the east section.

It had been presumed at the outset of excavation that a full west range had extended from the church to the fort wall. Accordingly two trenches (P2, P8) were excavated to locate respectively the east and west walls against the fort wall, and to examine as much as possible of the interior. The amount of post-medieval dumping limited the amount of ground area that could be examined.

In trench P2 the original front face of the Roman wall had been cut back extensively, except where the medieval priory wall abutted (pl. XXVa, b). What appeared to be the eastern wall of the west range rode up over the second offset of the Roman fort wall, and butted against the face of the top offset.

It consisted of loosely mortared flints, giving a maximum of four rough courses. Its west face was mortared to give a straight edge; the east face was irregular, but this could have been caused by later pits. No occupation or associated floor levels were seen.

To the west of this wall foundation there was a complicated sequence of deposits. Several pits had been cut into each other at various dates. A pit (P2, layer 20), containing fourteenth-century pottery, had been dug down against the Roman wall footing to a considerable depth. A pit or other feature (trench P2, layer 26), cutting the Roman and medieval walls in the eastern part of the trench, contained sixteenth-century and residual fourteenth-century material. A stone-lined soakaway or latrine pit (trench P2, layer 25) had been dug between the west side of the medieval wall and the cut-back Roman face. This had broken through the surface of the foundation revealing an extensive pattern of timber voids (Vol. I, pp. 13-17). The soakaway pit was larger than the stone latrine, and its fill had been forced some way down the timber voids. Pottery from the pit dated to about the fourteenth century. Perhaps the latrine was located within a structure leaning against the medieval wall.

This evidence suggests the medieval wall was standing in the fourteenth century, but the

¹ Hants CRO, *ibid.*

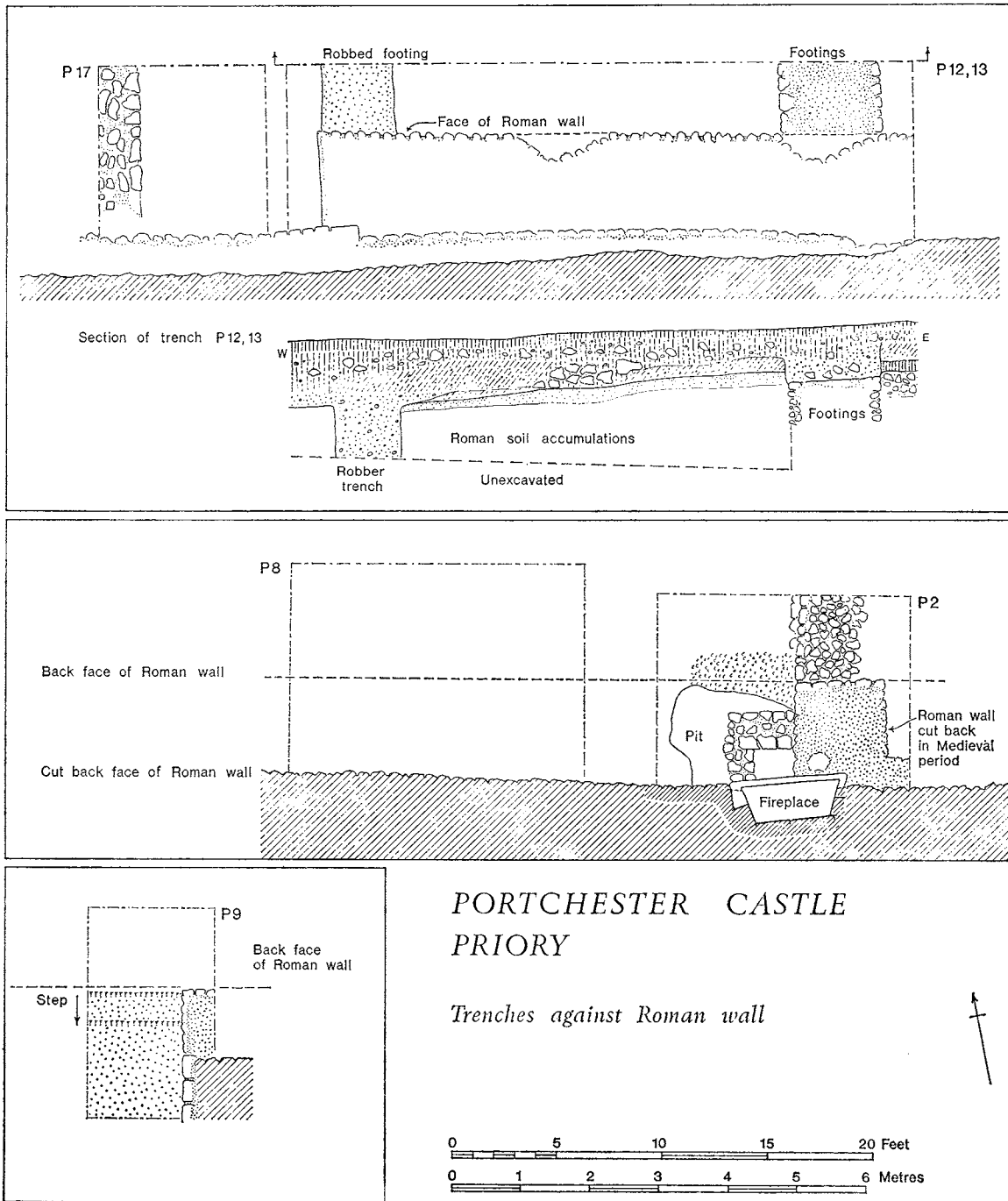

PORTCHESTER CASTLE
PRIORY

Trenches against Roman wall

FIG. 69

fireplace cut into the upstanding fort wall must date to a period after the medieval wall had been demolished. In plan it overlapped both latrine pit and medieval wall: sixteenth-century pottery was found in its fill. The hearth was set slightly askew to the axis of the main fort wall face, and was made of large (17 in., 0.43 m.), medium (12 by 9 in., 0.30 × 0.23 m.), and small (5 in., 0.13 m.) ashlar blocks, discoloured and with surfaces flaked by heat. Its sides, apart from one stone, had been robbed. Its floor was made of large, shaped greensand blocks, and it had a raised outer edge. The medieval fort wall was extensively refaced around the area of the fireplace. There must have been a structure around the fireplace, post-dating the priory wall and abutting the fort wall. No footings were seen and the ground in front was disturbed, so it is not certain whether it had been constructed in masonry or timber.

Trench P8 was excavated to the west of trench P2 with the intention of finding the other wall for the west range. In upper layers (especially layer 13) Tudor Green pottery was conspicuous, presumably indicating a sixteenth-century date, and perhaps associated with the fireplace and its building further to the east. One of these tips, which contained rather more flint than the others, was initially misinterpreted as the robber trench for the western wall of the west range. In fact no western range west wall was found, nor was there disturbance by later pits to allow an argument that all traces of a wall had been removed.

In the top surface of the eroded Roman wall a number of regular depressions were found, involving the removal of about one flint course. These probably represent scaffold poles against the refaced fort wall.

The South Range

The claustral complex normally includes a refectory opposite the church. Assuming one was built at Portchester, there are two possible locations. The refectory may have leant against the refaced Roman fort wall, even though later refacing could have obliterated all traces. In this case, the span of the range would place the foundations for its north wall where destruction by grave digging would be almost certain. Alternatively, the south range may have stood clear of the fort wall, to form a more exactly square cloister. In this case, all evidence is likely to have been destroyed by grave digging.

There must be some doubt as to whether a south range was completed in stone or completed at all. The evidence of trench P8 shows the west range must have terminated at some point north of the fort wall. Had the priory persisted at Portchester, the west range would no doubt have been fully completed. If the usual sequence of monastic construction were followed, the refectory may have been built in sequence following the church and east range, and before work on the main part of the west range started.

The Fort Wall (trenches P9, P10) (fig. 69)

Two trenches were excavated against the fort wall outside the immediate claustral area. They emphasized that all the available information about this quadrant could only be gained by a systematic trenching along the available 8 ft. (2.44 m.) strip. Much of this would probably relate to pits dug in all periods against the wall; only tantalizing glimpses

would be gained of other structures and features whose main parts had been destroyed by grave digging.

Trench P10 was excavated in the angle between the back face of the eastern fort wall, and the south face of the watergate. The evidence it produced was entirely Roman in date (Vol. I, pp. 34–6). No further evidence was seen to explain the row of corbels set into the back face of the eastern fort wall near the watergate.

Trench P9 was excavated against the fort wall by an entrance into bastion 15. It was placed astride the eastern side of the bastion and was intended to examine the Roman wall footings to see how they had been adapted in the medieval period.

A number of features were seen, but these were not fully understood within the limits of the area examined. The Roman wall had been cut into by a feature containing pottery of fourteenth-century date. Whether this was a pit or a means of gaining access to the bastion is uncertain. The eastern side of the cut into the Roman wall had been carefully refaced (pl. XXIVa). Irregularities in the floor level of the feature could be explained either by a systematic cutting into the various courses of the Roman wall, or as a deliberate device. Similarly, various holes in the revealed Roman wall level surfaces could be interpreted as either postholes belonging to a larger and not fully understood structure, or as accidental erosion.

ST MARY'S CHURCH

BY ALAN BORG

The church is a comparatively well preserved and fairly simple structure. It has been described in some detail in both the *V.C.H.* and by Pevsner.¹ The following account takes note of some features not previously recorded and an attempt is made to place the building within its regional context.

Date and History of the Building

The church is usually said to be closely dated to between the years 1133, when the Augustinian priory was founded by Henry I, and 1144–53, when the canons transferred themselves to Southwick.² In fact, neither of these events can be taken as firm evidence for dating the church. The charter establishing the Augustinian canons at Portchester suggests fairly strongly that a church was already in existence on the site,³ while St Mary's remained a parish church and the church of the castle after the canons had departed for Southwick. It is possible that a new church was ready in time for the arrival of the canons, or that they

¹ *V.C.H., Hants.*, Vol. III, pp. 151ff.; Pevsner and Lloyd, 1967, pp. 382–6. See also the available guide to the church, *The Ancient Priory Church of St Mary, Portchester* (Ramsgate, 1970); Peers, 1952; Renn, 1972. In addition, I am most grateful to Mr Stuart Rigold, for his advice and assistance.

² The date of departure cannot be precisely fixed; there are two bulls of Eugenius III (1145–53), one addressed to

the prior of Portchester, the other to the prior of Southwick. See Dickinson, 1950, p. 124.

³ W. Dugdale, *Monasticon Anglicanum* (ed. J. Caley, 1830) Vol. VI, p. 244, no. 1; *Sciatis me concessisse Deo et ecclesiae beatae Mariae de Porcestre et canonicis regularibus ibidem servientibus, ipsam ecclesiam S. Mariae ibidem a me fundatam, cum terris et decimis et omnibus rebus eidem ecclesiae pertinentibus.*

took over a pre-existing building, only beginning work on a new church after several years. However, the date limits 1133–53 accord in general terms with the style and decorative detail of the building, and the establishment and departure of the canons would explain its overall unity and the subsequent lack of alterations to the fabric. Detailed examination of the structure reveals a number of inconsistencies and alterations, but these may be put down, for the most part, to a measure of uncertainty and occasional incompetence on the part of the builders — elements which are familiar to any student of medieval architecture. The decoration of the building is, in fact, remarkably unified, and it is clear that there was only one major campaign of construction, which may be placed in the period *c.* 1130 (assuming the church could have been ready for the canons in 1133) to 1153. However, the actual building can hardly have taken more than three or four years, and it is worth trying to establish a rather more precise date.

There is some slight evidence that, when the canons left, the church was incomplete: there are wall shafts in the chancel and in the transepts which may imply that vaults were intended, but, at least in the transept, the vaults do not seem to have been constructed. In this case, it is arguable that plans for vaulting were abandoned when the canons departed, and the building was completed in a simpler and cheaper fashion. A second point is the disparity in the thickness of the nave walls. The north wall is on average 107 cm. thick at its base, while the south wall is only 76 cm. thick. The reason appears to be that the south wall was buttressed by the cloister; an explanation may be sought in the integral planning of the church with at least the northern cloister walk, though the possibility that the cloister predates the church should not be dismissed from consideration in any future investigation.¹

Despite this, the decoration of the present church is not particularly advanced for a date of *c.* 1140, and such a date presents some problems in terms of the closely related church at Petersfield (see below). On the other hand, the decorative detail at both Portchester and Petersfield is rich and elaborate, and the combination of motifs would be extremely unusual for *c.* 1120 (Pevsner's date for Petersfield). A date of *c.* 1130 would be more acceptable, and, in terms of the church at Portchester, there are no strong grounds for favouring 1140 as against 1130 — certainly it is not at present possible to date any of the decorative or architectural features more closely than within a decade. The slight inconsistencies and oddities in the church favour the later date, for the reasons given above.

The church has remained substantially as it was built in the twelfth century, and the major changes have consisted of subtractions rather than additions. The main alterations were carried out in the early seventeenth century, under the auspices of Sir Thomas Cornwallis, Constable of the castle. He died in 1618, and his monument is situated in the east chancel wall, the reconstruction of which he was responsible for, together with other alterations in the chancel. At the same time, the south transept was removed, presumably because it was in a state of decay, and, most probably, the northern doorway in the nave was blocked off in the same campaign.

In 1653 the church was used to hold Dutch prisoners taken by Admiral Blake in the Channel, and they apparently damaged the building and caused a fire. However, nothing was done for 50 years, and in 1705 the parishioners petitioned Queen Anne for assistance to

¹ There is no sign of any pre-twelfth-century masonry anywhere in the present church, but earlier fabric may have been recased during the main building, or patched at any subsequent period.

repair the church, which was 'the greatest part ruined'. This resulted in a Treasury Warrant, dated 11th December 1706, of £400 for the repair of the fabric, to be raised by the sale of firewood cut in Windsor Forest. The restoration was completed in 1710 and the church was re-opened with some festivities.¹ A large painted panel, set up on the north side of the nave, bears the royal arms and the inscription *By the Bounty of Queen Anne this Church was repaired and beautified, 1710*. In fact, major structural repairs do not seem to have been required at this time, and it is probable that the main damage was caused by fire in the roof. The present form of wooden roof dates from the 1705–10 restorations, although it has itself been restored in the nineteenth and twentieth centuries. Some small repairs were carried out to the structure in 1824, 1867 and 1888, the latter being the most extensive. These involved a certain amount of refacing, but were on the whole conservative. In 1951 the south wall was strengthened and the roof repaired. The most recent alteration is the construction, within the past few years, of a large new vestry on the south side of the nave.

Plan
(fig. 67)

The building originally comprised an aisleless nave, crossing, transepts with single chapel, and chancel. The south transept no longer exists, and the north transept chapel, together with the east end of the chancel, has been rebuilt. Consequently we cannot be sure about the precise form of the east end or of the chapels. The transept chapel is said to have been rebuilt (in 1864) on old foundations.² The excavations carried out by David Baker on the outside of the east chancel wall revealed very small traces of footings on both the north and south side. If these represent traces of an original wall it seems very probable that the chancel terminated with an apse (since a chancel consisting of two square bays is unlikely in a building of this size). In this case, the transept chapels were probably apsidal as well. However, the evidence is unclear, and the footings revealed in the excavations could represent a later addition to an originally square chancel.

There was no standard plan adopted by Augustinian canons in the twelfth century, and indeed Augustinian buildings vary widely in form and appearance (Clapham, 1934, pp. 83–4). Generally their churches belong to local traditions, and this seems to be so at Portchester, where the plan may be compared with contemporary parish churches of the region. At St Nicolas, Old Shoreham, a Saxon church was altered in the twelfth century to present a plan of an aisleless nave, projecting transepts each with a single chapel, and a chancel of one bay. The transept chapels and the chancel were all apsidal, which could be a pointer to the Portchester plan, since, as we shall see, the two buildings are linked in other ways. Another related building is the problematic (and much altered) church of St Peter, Petersfield, where the original plan again seems to have been similar to that of Portchester.

Description

The church is faced in ashlar both inside and out. The block size varies considerably, and in this the church resembles the keep of the castle.

¹ See Woodward, Wilks and Lockhart, 1858–69, p. 331; also the guide to the church (p. 105, note 1), p. 8.

² *V.C.H., Hants*, Vol. III, p. 160. No authority is given for this statement.

The west front (pls. XXVII, XXVIII) is gabled and strengthened by corner buttresses. The central doorway is surmounted by a window, which is flanked by a pair of blind arched recesses of slightly smaller size. At its base the façade wall is some 152 cm. thick, and this may be compared with the 107 cm. of the north wall of the nave. At the level of the sill of the central window the façade wall is stepped back on the inside, reducing the thickness. Again, above the central window the wall is chamfered back inside and out, producing a comparatively thin gable wall. The façade buttresses themselves are quite massive; that on the north-west corner is completely preserved, while the corresponding buttress on the south-west corner is preserved only on its west face (presumably because the cloister buildings abutted the south wall at this point). The size of the corner buttresses, taken in conjunction with the thickness of the lower façade wall, suggest that there may have been an intention to construct a more substantial façade, perhaps with flanking turrets. However, any such plans were abandoned in the course of the construction, and one cannot now establish the original intention. As it stands, the articulation of the façade is squashed between the relatively massive flanking buttresses, which is visually unsuccessful.

Within this frame, the elements of the doorway and the triple arcade above are decorated in a fairly elaborate fashion. The doorway is formed by a round-headed arch of three orders (pl. XXVIII*b*), the outer two of which are divided by thick roll mouldings, supported on inset shafts, while the innermost order is plain, with squared jambs. The arch of the innermost order is decorated with saw tooth, and the middle order bears a series of small roundels filled with schematic flower forms, each consisting of a sexfoil with a central ball. The second roundel on each side of the arch contains a sign of the zodiac: on the north Pisces, and on the south Sagittarius (both badly worn). These, the only examples of figure sculpture in the fabric of the church (apart from a small dragon's head label stop in the transept), have given rise to symbolic interpretations. It has been proposed that the Pisces stands for Christ and the Sagittarius, as the badge of King Stephen, indicates the period in which the building was completed. This can be discounted and it is probable that the two signs have no special significance in this context.

The outer order of the arch is decorated with a chevron pattern, consisting of three strands of low relief zigzags, the innermost of which has a small ball terminal to each V. The label of the arch bears a pattern formed of roundels, each of which contains a concave-sided lozenge. At the base of the arch, at the level of the abaci of the capitals, is a narrow horizontal band, carved with a lozenge pattern in low relief, and this continues along the wall beyond the outer order of the arch and runs directly into the buttresses. On either side of the door is a pair of inset shafts, corresponding to the roll mouldings of the arch, and these are decorated with an incised spiral pattern (apart from the outer shaft on the south side, which has a pattern of superimposed Vs). The two capitals on the north side of the doorway are decorated simply with scroll volutes, with, at the centre of the face, a vertical lanceolate leaf. Both capitals are very worn, but that of the outer order is clearly unfinished. On the south side the capitals are cut back at the corners to produce a broad pointed leaf, with a central rib, and again narrow lanceolate leaves at the centre of the face. The bases of the shafts are of normal torus and scotia form, with a steep profile. The whole doorway is comparatively little restored, although sections of the lozenge pattern at abacus level and parts of the label have been renewed, and the innermost capital on the south side is a restoration.

Above the west door is a window, flanked by narrower blind arched recesses (pl. XXVIII*a*). The sill of the window drops below the base of the recesses. Each of the three arches is of a single order, with roll mouldings supported on inset shafts. The capitals are plain, of cushion form, but the arches are decorated with a single strand of chevron, and the narrow vertical spaces between the shafts of the central window and the flanking arches are decorated with two opposing strands of chevron, forming a lozenge pattern. The blind recesses themselves are filled with a pattern of circles containing concave-sided lozenges.

On its inner face the arch of the doorway consists of two orders, with inset shafts and roll mouldings, and with chevron ornament of the same form as the exterior on the outer order. The inner face of the west window consists of a single order, with inset shafts, plain capitals, and roll moulding on the arch.

The nave is a simple and plain structure, both inside and out (pls. XXIX, XXX). Just below the windowsill level a plain chamfered string course runs the full length on the interior. There are five round-headed windows on the south side, regularly spaced, although the westernmost is blocked (presumably from an early date, by the construction of the west wing of the cloister and claustral buildings). On the north side there are matching windows, except that the place of the central window was taken by a tall doorway, now blocked. The windows are plain, with simple splayed jambs, and on the interior they are stepped at the base (cf. windows on the south side of the main floor of the castle keep). On the south side there are traces of two cloister doorways. That to the west, between the first and second windows, consists of a plain round-headed arch, and now leads to the new vestry. To the east, close to the crossing, there are traces of two intersecting doorway arches. Much of the stone around these arches has been renewed, but it is clear that the upper arch is the earlier feature, since it is intersected and cut short by the lower one. It seems that a cloister doorway was begun or intended at this point, and shortly after it was moved slightly to the west and lowered. However, the anomaly persists, for even the second arch is some 15 cm. higher than the western cloister doorway and at its apex it would have touched the string course. In fact, the string course does not continue on the south side beyond the eastern splay of the easternmost window, and so the problem is avoided. The two arches clearly represent a minor alteration in the design, but whether either doorway was ever completed, or at what date they were blocked, remains unknown.

On the north side of the nave, opposite the central window on the south side, is a tall blocked doorway (pl. XXXI*a*). The jambs and voussoirs are clearly visible, and the surrounding masonry shows signs of alteration. To the immediate west of the doorway the string course has been cut back on one block, and this and the stone below appear to have been cut to receive the lower voussoirs of the door arch. This might indicate that the doorway itself was only inserted in the course of building, but it is impossible to be certain since the whole area has been altered by the blocking of the door and subsequent stone patching. On either side of the arch is a single stone bearing the concave-sided lozenge pattern seen in the arcaded recesses of the west front.

At the east end of the nave, on the north side is a small squint window (Green, 1929, pp. 164-5), of indeterminate date, and the *V.C.H.* is probably correct in suggesting that this was intended to light an altar below a rood loft.¹ Above this window, as on the south side,

¹ *Ibid.*

the string course is discontinued, but in this case the reason is probably to be sought in the original insertion of the rood and the later insertion of the wall plaque to Thomas Luttmann.

The nave is covered by an eighteenth-century wooden truss roof, but it must always have been roofed in wood since there is no provision for any kind of vaulting. The masonry of the nave walls appears to be homogeneous, although there is a considerable amount of later patching. At the south-west angle between the nave and façade the coursing is discontinuous (the corresponding north-west angle is obscured by modern fittings). There is similar discontinuity of coursing between the nave walls and the crossing, especially in the area below the string course. However, such masonry breaks cannot be taken to indicate any significant breaks in the construction of the building, for, as we shall see, the decoration throughout is remarkably unified.

On the exterior, the north side of the nave is plain (pl. XXIX), with simple window openings, between each of which is a plain shallow pilaster buttress. Below the windows is a chamfered string course, corresponding to that on the inside, which runs into but not around the buttresses. It has been noted that the central north door is blocked, and on the exterior the area between the middle two buttresses is filled in to the depth of the buttresses. On this wall surface the outline of the gable of the door is visible, and on the lower surface are four or five stones, set at random, bearing a diaper pattern — presumably fragments of the original decoration of the doorway. There is no evidence as to when the door was blocked, but the presumption is that this was done in the early seventeenth century, when the other major changes were made.

In the westernmost bay on the north side, above the window, there is evidence of a slight alteration in the line of the wall, perhaps an original correction to the building.

The south side of the nave on the exterior is now partly obscured by the modern vestry, but it resembles the north except that the buttresses are stopped on a simple chamfered ledge, which runs the length of the nave just below the windows. The reason for this is that the cloister abutted the church at this point. The lower part of the wall is plain, and has been much restored, although there are traces at both east and west ends of a low string course. The whole of the westernmost bay, between the final buttress and the corner buttress of the façade, has been thickened to the depth of the buttresses (so blocking the westernmost window), presumably as a result of the construction of the cloister and associated buildings.

The crossing arches are large and impressive features (pl. XXX). Each arch is of two squared orders, with a bold roll moulding between. The inner order is supported by a half column and capital, flanked by inset shafts and capitals, supporting the roll moulding. The arches are plain, but for a label of boldly formed billet. The capitals are all carved from the adjoining block (i.e. they are not free standing). Those of the half columns, which are the same height but roughly twice the width of the shaft capitals, are of three types: (1) scalloped cushion, with vertical striations on the bell (pl. XXXIIa); (2) volute form, with a spray of rudimentary lanceolate leaves at the centre of the face (pl. XXXIIb); (3) similar to the latter, except that the volutes are replaced by broad pointed leaves (pl. XXXIb). In the second type the volutes are prominent features, unlike the lightly incised volutes seen on the west front capitals. The shaft capitals follow the same three types, with the notable exception of the western shaft capital on the north side of the chancel arch, which is covered with a

pattern of small overlapping leaves or scales (pl. XXXII*b*). The half columns and shafts are plain, and the bases similar in form to those of the west front.

The four crossing arches form a square, which on the interior is covered with a flat wooden roof. Just below this roof is a string course consisting of a double row of billet. The upper floor of the tower originally opened on to the nave, transepts, and chancel through pairs of plain round-headed arches, which are now blocked (except for the western opening in the north transept, which provides access to the tower).

On the exterior the tower appears low, hardly rising above the apexes of the nave and transept roofs. It has a plain, squared appearance, each face bearing a pair of small plain bell openings. The regularity of the exterior is broken by a stair turret on the north-east corner and an angle shaft on the north-west corner. It seems probable that in the first instance a somewhat higher tower was intended. The whole is now covered by a low pyramidal roof.

The north transept is well preserved, although the chapel and certain other features have been renewed. The interior forms a rectangular vessel, with inset shafts at the corners. These shafts and their capitals rise to the same height as the crossing piers, and are then continued by squared wall shafts. This somewhat unusual arrangement could suggest an intention to vault the transept, but there is no indication that vaults were ever constructed. The shafts are coursed into the wall, but that in the south-west corner terminates well below the top of the wall, again indicating that plans were changed in the course of construction.

In the south-west corner there is a doorway, in its present form entirely nineteenth-century, which possibly represents an original feature. The lower walls of the transept carry a blind arcade (cf. the chancel), consisting of round-headed arches supported on shafts and capitals. All the capitals are of early gothic form and almost all of them are clearly nineteenth-century. However, Pevsner queried whether those of the north side might not be original, representing an alteration or repair of *c.* 1200 (Pevsner and Lloyd, 1967, p. 385). Certainly these capitals are more worn than the others, and consequently look older, but this appears to be because they are of softer stone. On stylistic grounds it is difficult to accept any of them as genuine, and in addition it is unlikely that any such repairs would have been contemplated at Portchester *c.* 1200, since the church was already of minor status.

Above the blind arcade is a simple chamfered string course, at the same height and of the same form as that in the nave. There is a single western window, of one order with inset shafts. The arch is decorated with an unusual triple bar pattern, consisting of radiating lines set in groups of three, with recessed spaces between (pl. XXXIII*b*). The label bears a lozenge pattern. The main north window is of the same form and decoration, and this is surmounted by a single plain light in the gable. The north-west corner of the transept contains a stair turret, leading to a gantry below the roof which gives access to the tower. The arch giving on to the eastern chapel is decorated with chevron (pl. XXXIII*a*), with the same ball terminals to the Vs seen on the west door. It is supported by inset shafts, with simple scalloped cushion capitals. However, these shafts are not aligned with the roll moulding of the arch, the latter being set back from the shafts. This is visually awkward, and elsewhere in the building shafts are aligned with roll mouldings, once more suggesting that there were miscalculations or alterations to the transept in the course of construction. This impression is confirmed by the fact that, at the level of the abaci of the shaft capitals, there is a fragmentary chamfered string course, resulting in two superimposed string courses on the east

transept wall. These oddities might have been clarified had the transept chapel survived, but the present rectangular structure dates from 1864.

On the exterior the north transept is plain, the windows of the same form as those in the nave and with the same string course below. The north wall is supported by two plain corner buttresses, which reach to gable height.

The south transept is lost, and the southern crossing arch is closed by a roughly built wall, presumably constructed in the seventeenth century (pl. XXXIV). However, the corner shafts of the transept survive, and, like those of the north transept, they are surmounted by squared wall shafts.

The chancel is rectangular, and shows considerable signs of alteration. It has been much lowered, and the walls now barely reach above the height of the crossing piers. In the corners are inset shafts, as in the transepts, but there is now no trace of the squared wall shafts which they presumably carried. The interior side walls bear a blind arcade, of which only the arches and springers remain (cf. the transept). Above the arcade is a string course. Adjacent to the crossing, on both north and south sides, the arcade is interrupted by a low doorway. That to the north now leads into the transept chapel, that to the south is blocked. The rebuilt east wall of the chancel is pierced by a simple window of late perpendicular form, and to the south of this is the monument to Cornwallis, who is represented as a small half-figure in armour. On the outside, the north and south chancel walls have been largely refaced, presumably when the east wall was built.

Portchester Church and Related Works

In most respects Portchester church is a fairly standard building, of moderate size and decorated in a rather smart way. However, there are certain aspects, both general and specific, which deserve further consideration. Its relationship to the castle is obviously significant, and it should be considered alongside the twelfth-century keep. It shares the same form of ashlar construction, and the sills of the nave windows are stepped like those in the keep. However, the very plain windows in the keep, with inset shafts and undecorated capitals, can be related only in general terms to the work in the church, and otherwise the keep is devoid of decoration. For this reason it is not possible to assert that the keep and the church are exactly contemporary or that they were built by the same masons.

A curious feature of the church is the number of doorways. Assuming the nineteenth-century doorway in the transept represents an original feature, the building appears to have been provided with seven entrances. Those on the south side of the nave and in the chancel were presumably specifically for the canons, but it seems odd that, in addition to an elaborate western entrance, a large northern doorway was also included. On the whole, doorways and windows were provided in medieval buildings to meet practical requirements, and, as we have seen, there is some slight evidence that the northern entrance was only decided upon in the course of construction. The most likely explanation would be that this was the most convenient for use by dignitaries from the castle.

In general terms, the façade of the church, with its articulation of arches, suggests connections with buildings in Normandy and western France, while certain details of the decoration, such as the rosette pattern on the western doorway arch, can be compared with motifs

found in Italian Romanesque architecture. However, it is probably a mistake to try to interpret Portchester in an international context, and any continental features which are present are likely to have been derived at second or third hand. For the most part, the decorative forms employed in the building are fairly standard. Lozenge patterns and billet mouldings are very common, and saw-tooth mouldings can be found in several Hampshire churches (e.g. East Meon, Droxford, Andover, Hurstbourne Tarrant). There are three specific forms at Portchester which are less usual: the pattern of concave sided lozenges set in circles (label of west doorway and blind recesses of façade), the chevron with ball terminals (west door and chapel arch), and the triple bar pattern (transept windows). None of these forms can be found in the major twelfth-century buildings of the area (in Winchester, Romsey Abbey, Christchurch, St Thomas', Portsmouth), although the concave lozenges, together with floral rosettes, can be found in the architectural fragments recovered from Old Sarum. The significance of this connection is difficult to assess, since neither the chevron and ball nor the triple bar pattern has been found at Old Sarum.

There are some more closely related buildings, which appear to be the work of the masons who built Portchester. Closest of all, in terms of decoration, is the parish church of St John the Baptist, Yaverland, on the Isle of Wight.¹ This is a tiny chapel, originally comprising a plain rectangular nave (later extended by a north aisle) and a small rectangular chancel. It must have been built as a chapel for the adjacent manor, held in the twelfth century by the Aula family. The doorway arch on the south side, is decorated with the characteristic triple bar pattern, with single strand chevron on the label (pl. XXXVI*a*). The tympanum contains the concave-sided lozenges found in the arcades of the Portchester façade. On the inside the chancel arch bears the chevron and ball pattern of the Portchester west door (pl. XXXVI*b*), with opposed chevrons forming lozenges on the label (Portchester, shafts of façade arcade). The occurrence of these various rather unusual elements in combination at both Yaverland and Portchester suggests that both are the work of the same masons.

A third church in this group is St Peter's, Petersfield.² This much-restored building assumed its present aisled form as the result of two twelfth-century campaigns. In its first phase the church was, as has been noted, similar in plan to Portchester, and the crossing arches and west door belong with this phase. The crossing arches adopt the same form as Portchester, while above the western arch is an elaborate triple arcade, decorated with chevron and the triple bar pattern (pl. XXXVII*a*). The west doorway arch bears the chevron and ball; this is almost totally restored, but two original voussoirs survive to prove that the original pattern has been followed (pl. XXXVII*b*). It also appears that Petersfield, in its first phase, was faced with ashlar inside and out.

The clear connection between Petersfield and Portchester raises rather more problems than it solves. The nature of the original foundation at Petersfield is unclear, for the church preceded the town; it seems to have been intended as a well-made and rather lavishly adorned small building, and it is tempting to see it as some sort of collegiate foundation, which would provide a further parallel with Portchester. However, no evidence to support this hypothesis has yet been found. The date of the first phase of building at Petersfield also raises problems.

¹ *V.C.H., Hants.*, Vol. V, pp. 206–8; Pevsner and Lloyd, 1967, pp. 777–8.

² *V.C.H., Hants.*, Vol. III, pp. 111–21; Pevsner and Lloyd, 1967, pp. 371–2; *Notes on Petersfield Parish Church* (available guide, published 1972).

It is very close in its decoration to Portchester, yet the bases look earlier, and Pevsner dated the first stage to *c.* 1120. This would conflict with the date of *c.* 1140 proposed here for Portchester, but the explanation may well be that Petersfield is a case of very slow building, and the first phase was probably never completed. At any rate, radical changes were made in the second half of the twelfth century, when aisles were added and a western tower constructed (a fact which in itself implies that the crossing tower was incomplete at that time).

Another related church is St Nicolas, Old Shoreham, which is again a somewhat complicated structure, involving a twelfth-century enlargement of a pre-Conquest building, which was in turn substantially altered in the late thirteenth-century.¹ The twelfth-century work consisted of the addition of transepts and east end to the pre-existing fabric, resulting in a plan which resembled that of Portchester. The south transept doorway is decorated with the triple bar pattern (pl. XXXVIII*a*), and the form of the crossing arches is the same as at Portchester; however, the form and decoration of the scalloped crossing capitals at Shoreham suggests that this is the latest extant work of the Portchester group.

The church of the Assumption of the Blessed Virgin Mary at East Wittering is a plain and simple structure, resembling the church at Yaverland.² The entrance is through a doorway on the south side, and the arch of this is decorated with a rather low relief version of the chevron and ball pattern. There is no other decoration, but the rarity of this motif suggests that East Wittering can also be attributed to the Portchester group. More distantly related is the arch of the doorway at Natley Scures (Hants),³ which bears a chevron pattern on the main face and on the soffit, joined by balls on the arris. This would seem to be a later variation on the theme.

The Font
(pl. XXXIX*a, b*)

This is of simple tub-shaped form, decorated with an intersecting blind arcade, surmounted by an inhabited scroll. The entire lower section, from the spandrels of the intersecting arcade, is a nineteenth-century restoration.

It is at once clear that the decoration of the font is not connected with the architectural decoration of the church. The bold scroll at the top of the font is formed of a thick, fleshy stem forming a tight *rinseau*, filled with foliage, flowers, birds, and human figures. The type and form of this decoration immediately suggest a connection with the mid twelfth-century work of the Winchester school, where such tight scrolls, Byzantine blossoms and figures enmeshed in turning stems are characteristic. This style had its origins in manuscript painting, but it was successfully adapted to stone sculpture, at Winchester itself and at other influential centres, such as Reading Abbey. The scroll patterns seen on the Portchester font can be compared with surviving capitals from Hyde Abbey, while there is a second font, perhaps by the same artist, in St Michael's church, Alphinton, Devon.⁴ The latter is identical to the Portchester font in form and decoration, but the carving is rather less accomplished. A date of *c.* 1150 for both fonts may be suggested.

¹ Simpson, 1971.

² *V.C.H., Sussex*, Vol. IV, p. 216.

³ *V.C.H. Sussex*, Vol. IV, p. 154.

⁴ Zarnecki, 1953, p. 53.

The Portchester font points up the fact that the church, while belonging to a small and clearly defined group of buildings, has no direct links with the Winchester school. It would seem that the men who built Portchester, and the other buildings in the group, belonged to a stratum of artists and craftsmen which operated largely independently of the major 'cathedral' workshops. However, given the comparatively modest scale of their operations, the Portchester masons produced attractive and competent structures, employing a distinctive decorative repertoire.

GENERAL DISCUSSION OF THE PRIORY¹

BY DAVID BAKER

Excavation produced no evidence at Portchester of a parish church predating the priory church on or near the same site, though the opportunities were limited and the ground frequently disturbed. The problem is not whether there was a pre-existing church, but where it was sited, since the foundation charter suggests that one was already in existence. The adjacent quadrant has been shown to have had an extensive sequence of occupation in the Saxon period, with substantial complexes of buildings. Their relationship to a Saxon village of Portchester is not clear, but a church should be expected within or without the fort, in wood or stone.

The position of the priory church was probably determined by the ready-made enclosure of the fort's south-eastern angle, leaving sufficient space for the claustral buildings. As recent large-scale church excavations elsewhere have indicated, it would have been quite possible for the limited excavations at Portchester to miss completely the evidence for an earlier building on or near to the same site as the later church. There is also plenty of room in the unexplored graveyard around the priory for several undetected churches. It is not known whether the interior of the fort was carefully divided into plots in the Saxon period, as for the late eleventh and early twelfth centuries, thereby tending to stabilize the positions of successive church buildings, or whether the lack of such constraints allowed successive structures to wander from site to site. Perhaps a religious function might be sought for the late Saxon masonry tower (Cunliffe, 1976, p. 60).

There is no evidence that the claustral buildings were erected against a pre-existing parish church which was later replaced by the priory church. The unity of footing construction between church, south transept, and west range point to a single campaign of work. Slight differences in the superstructural alignment of walls separated by the crossing might be explained by the Norman habit of placing narrower walls upon wider strip footings.

Excavation has also added little to general understanding of the priory itself. Previously, the existence of church, dormitory range with two-storey rere-dorter and west range was clear, and the completion of a roughly square cloister with a south refectory range could be assumed by analogy with other houses. The south end of the west range had left no traces upon the face of the fort wall, though these could have been obliterated by later patching

¹ I am glad to acknowledge the advice of Messrs R. Gilyard-Beer and S. E. Rigold on aspects of this discussion, though I accept full responsibility for any aberrant monastic comparisons which have survived their helpful comments.

and refacing. There is new evidence that the west range was never completed, at least not in stone.

A neglected topic in monastic archaeology is the temporary accommodation which must have been used by the first generations of religious during the interval between arrival at the site and the completion of permanent buildings. Few temporary timber structures have been recognized, perhaps because they would usually have been sited close to, but not on,

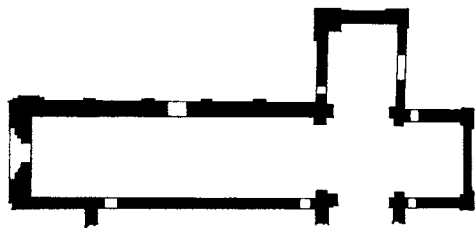
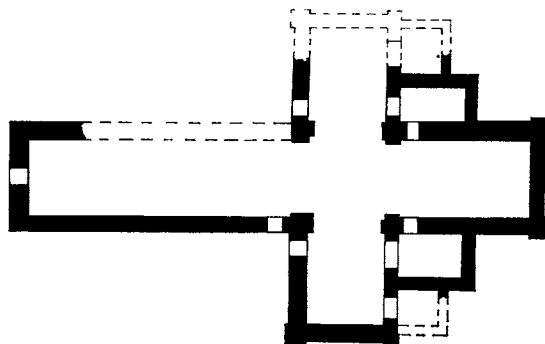
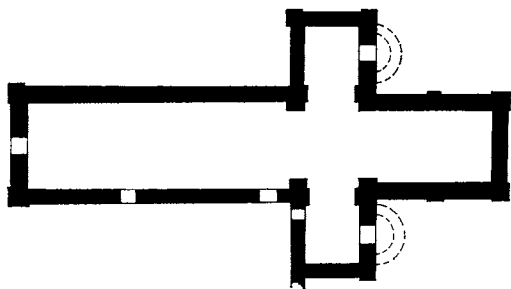
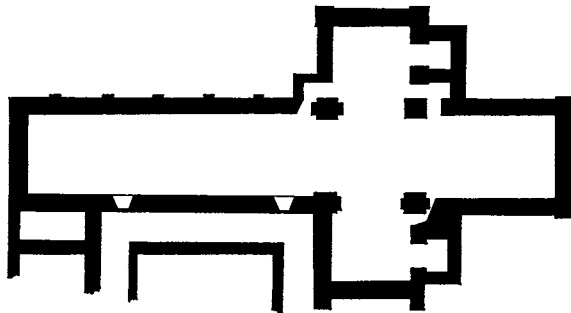
PORTCHESTER*EWENNY**ST LEONARD STANLEY**NORTON*

0 10 20 30 metres

FIG. 70. Comparative plans of Augustinian establishments

the site of their permanent successors, and would only be located in the course of extensive excavation, such as recently at Norton Priory, Cheshire.¹ The limitations on excavation at Portchester make the discovery of such structures extremely unlikely, but future workers should not neglect the possibility.

The sequence of construction at Portchester is obscure. It would be usual for the church

¹ Information kindly supplied by the excavator, J. Patrick Greene.

and the east range to be followed by the south range, and lastly by the *cellarium*, which may have been only partly completed at the abandonment of the site. In comparison with some other houses this would represent a comparatively rapid construction programme, perhaps explained by the sharing of an outer bailey with a growing royal castle.

Reconstruction of Portchester Priory by comparison with contemporary monastic and parish church sites is limited by three main factors. The first is its short life of 20 years and cramped position in the angle of the fort, two reasons why the fabric should have been untypically fossilized at an early stage. Town monastic sites might provide parallels for such restricted plans, but few early examples are known in any detail. Alan Borg has stated the second factor: small mid twelfth-century monastic churches are better seen in their immediate local tradition, which mainly includes parish churches, rather than in comparison with other English or continental houses of the same order and date, especially in the case of the Augustinian canons, who were normally under diocesan control (above p. 107). The third factor is a general comment on the present state of monastic archaeology. Thanks to the labours of Knowles and Hadcock (1971,) the names of nearly all medieval religious houses are known, numbering over 1000. Yet in many cases uncertainties persist over dates of foundation and over actual locations. Relatively few known sites have been excavated: only a few of these have been dissected with modern techniques down to their earliest layers over most of their ground area. Consequently most is known about those buildings which Henry VIII dissolved, and much less about their predecessors on the same site. The sample of excavated sites is also biased towards the greater houses.

Alan Borg has discussed the affinities of Portchester with local parish churches, so some comparisons are made here with contemporary monastic houses, both to illustrate the imperfect state of knowledge, and draw together some common and contrasting threads among these early plans. Knowles and Hadcock list 245 principal and lesser houses of Augustinian canons. About 120 or half were founded in the period 1120–75, and for less than 10% of these are parts of primary plans known. The small selection of parallel sites discussed below is distributed widely throughout England and Wales, and includes non-Augustinian houses on the assumption that size and date are factors at least as important as order, especially with smaller churches.

Churches of Augustinian canons were the subject of articles by J. F. Hodgson in the 1880s, following a series of somewhat sweeping generalizations made by J. T. Micklethwaite from the evidence at Lanercost (Micklethwaite, 1882). Hodgson spilt much ink in a series of refutatory studies (Hodgson, 1884, 1885, 1886), which showed a considerable diversity of plan amongst the churches of canons and other orders, but did not develop in detail any alternative schemes. The comments which follow do not attempt to fill this gap, and are minimal observations based upon problems of plan suggested by Portchester Priory.

Three houses provide fairly complete parallels for Portchester. *Leonard Stanley Priory* (Glos., AC) (Swynnerton, 1921) was founded after 1121, and its first church must have been started only a few years later. Like Portchester it has been relatively little altered, and most of the claustral buildings have disappeared: it enjoyed independent existence only until 1146. The building has been investigated more in the process of repair than by excavation. *Norton Priory* (Cheshire, AC) (Greene, 1972, 1973)¹ founded on that site in 1134, is one of the

¹ I am most grateful to Patrick Greene for discussing his results in detail.

most completely excavated sites of recent years: as a result, unusually, a fairly detailed ground plan has been recovered for the mid twelfth-century claustral complex. *Ewenny Priory* (Glam., Ben) (Radford, 1952) was founded in 1141, and has a mid twelfth-century church which can be largely reconstructed, though the nave belongs to a pre-existing parish church of the early twelfth century (fig. 70).

Several other houses might provide parallels for Portchester, but there are serious gaps in the evidence at present. *Butley Priory* (Suffolk, AC) (Myres, 1933), founded in 1171, was partly excavated in 1933, but several matters, including the nature of the early choir and chancel, were obscured by modern farm buildings and a road. *Kirkham Priory* (Yorks, AC) (Peers, 1946) was founded in 1122–30. The first church of c. 1140 was small: sufficient traces survive to show it was similar to Portchester, but the later twelfth- and thirteenth-century rebuildings have overlaid the original form which can only be established by excavation. Current excavations at *Haughmond Abbey* (Shrops., AC) are adding to the fragmentary evidence for the early church, parts of which may date from the 1130s.¹

In two cases there are churches with similarities of plan, but with more elaborate elevations, and constructed over a longer period. At *Llanthony Priory* (Mon., AC) (Craster, 1963) the eastern part of the earliest known church dates from 1180–1200, though the foundation is dated to c. 1108. The aisled nave was the product of an early thirteenth-century campaign. The monastic buildings during the first three-quarters of a century present an intriguing problem for solution by future excavation. *Lanercost Priory* (Cumbs., AC) (Eden, 1958), founded c. 1166, shows some indication of a simple early church, though there is also evidence that plans were altered in the course of a lengthy building campaign.

Some contrasts may be provided by *West Malling Abbey* (Kent, Ben Nuns) (Elliston-Erwood, 1954), founded c. 1090, with an early church of c. 1100. The published plan shows a version of the smaller aisleless church of the generation preceding Portchester, but there are major unsolved problems east of the central tower. *Dudley Priory* (Worcs., CI) (Radford, 1940) was founded slightly later than Portchester, in 1149–60, but a reconstruction of the earlier church plan shows apses to the chancel and transept chapels.

A discussion centred upon Portchester Priory has to be limited to the church itself. The type falls into the category of development described by R. Gilyard-Beer as 'austere planning' (Gilyard-Beer, 1958). The plan is cruciform, with aisleless nave and chancel, and transeptal chapels rather than choir aisles; the style is Norman rather than Early English. It pre-dates the later elaboration of chapels, the addition of aisles and the extension of chancels in secondary building campaigns, which took place in many cases during the later twelfth and thirteenth centuries. The buildings reflect partly the modest resources available in the early years, and partly a restrained mode of architectural expression similar to, but distinct from, the austere and simple plans of the reforming orders, the Grandmontines, the Premonstratensians and the Cistercians, not discussed here.

Before excavations were commenced, the original shape of *chancel termination* at Portchester in the 1130s could have been reconstructed as apsidal or squared. It is clear, not least from the houses discussed here, that there was no definite transition from one form to the other. An apse might be expected c. 1100 at West Malling and at other contemporary churches. Leonard Stanley and Norton, founded respectively a decade earlier and a year later than

¹ Gilyard-Beer (1958, fig. 6, vi); Geoffrey West is currently excavating for the Department of the Environment.

Portchester, both had square-ended chancels. But the reconstruction of Dudley, founded over a decade later, shows apses for both chancel and transept chapels. At Portchester the archaeological evidence points to a chancel unfinished during the canons' occupation, but one can speculate on the chosen form had the opportunity to complete the east end existed during the primary building campaign.

The evidence for a shortened and unfinished *chancel length* at Portchester is strengthened in the light of parallels. The distance between the east side of the crossing and the presumed east wall is about half that for the other Augustinian houses considered here. Only early Haughmond seems comparable, but the evidence here is fragmentary and in process of clarification. A related feature is that Portchester's transeptal chapels were not integrated within the main structure of longer transepts. This could give an illusion from outside of a relatively shorter choir-chancel length, as in some early Cistercian houses, and as at Ewenny which had a three-bay chancel.

The *transept chapels* at Portchester also provide problems of reconstruction. The east wall of the north transept, with its single Norman arch, suggests an apsidal termination on analogy with Leonard Stanley and Dudley. Yet there are Norman doors on each side of the chancel: in this case they would have led outside the buildings altogether, between chancel and apse. At Llanthony, Norton and Ewenny such doors led into a square chapel abutting the north side of the chancel.

The *crossing* is particularly important for communication between the four arms of aisleless churches. At Norton and Kirkham (1180 rebuild) there are wall passages which give access respectively between nave and north transept, choir and south transept (Norton), and nave and north transept (Kirkham). There are no signs of such an arrangement at Portchester which, in common with Ewenny and Kirkham, has a door at the south end of the west wall of the north transept, allowing direct access to the transepts and choir from outside without going through the nave. There are problems in pursuing this topic when much of the available evidence consists of strip footings uninterrupted for the door openings in the walls which stood upon them.

The churches in this group generally had aisleless naves in their early stages. There are variations within the group for *proportional lengths of nave to chancel*. At Leonard Stanley, Ewenny and Norton this is more or less 2 to 1. Portchester is 4 to 1, but, had its chancel been originally built of two bays, would have been nearer 2 to 1. At West Malling the ratio was nearly 3 to 1, excluding western tower and eastern chapel. Butley had a nave of exceptional length: if its chancel was of only two bays, the ratio would still have been between 4 and 3 to 1.

Excavation has not added much to the history of the priory after the canons had left. It might be inferred that the extra bay was attached to the chancel following their brief tenure, but this sequence cannot be proved. The only point of certainty is that the added portion must have been removed by the death of Sir Thomas Cornwallis whose memorial is attached to the blocking wall across the east end. A similar problem exists with the northern transept and its chapel of 1864. A plan of 1815 shows the transept without a chapel, the date of whose removal is unknown.¹ Pottery evidence indicates parts of the eastern range remain-

¹ Hants. C.R.O. 4 M 53. Counterpart lease from Thomas Thistlethwayte to H.M. Commissioners for Barracks, 31st May 1815.

ing in use for some centuries after the departure of the canons: the survival of the embrasure and garderobe chutes in the fort wall, amid so much medieval and post-medieval patching and refacing, would support this. Perhaps the priory buildings served as a quarry for successive repairs and extensions within the inner bailey: it contains Norman features which could have been transferred almost as easily from the church as from within the bailey itself. In any event this must be surmise, since the church only starts to be mentioned after the castle has ceased to have any strategic military value.

BIBLIOGRAPHY

- CLAPHAM, A. W. 1934. *English Romanesque Architecture after the Conquest* (Oxford).
- CRASTER, O. E. 1963. *Llanthony Priory, Monmouthshire* (H.M.S.O.).
- DICKINSON, J. C. 1950. *The Origins of the Austin Canons and their Introduction into England* (London).
- EDEN, P. 1958. 'Lanercost Priory.' *Arch. J.* cxv, 220-5.
- ELLISTON-ERWOOD. 1954. 'The Plan of the Abbey Church of the Benedictine Nunnery of Stuart Mary, West Malling, Kent.' *Antiq. J.* xxxiv, 55-63.
- GILYARD-BEER, R. 1958. *Abbeys* (H.M.S.O.).
- GREEN, A. R. 1929. 'An alphabetical list, with descriptions, of the low side windows of Hampshire churches.' *Proc. Hants Field Club* x (1926-30), 148-77.
- GREENE, J. P. 1972. *Norton Priory Excavations 1971* (Runcorn Development Corporation).
- GREENE, J. P. 1973. *Norton Priory Excavations 1972* (Runcorn Development Corporation).
- HODGSON, J. F. 1884. 'On the difference of plan alleged to exist between churches of Austin Canons and those of monks; and the frequency with which such churches were parochial.' *Arch. J.* xli, 374-414.
- HODGSON, J. F. 1885. (Continuation of paper of 1884). *Arch. J.* xlii, 96-119, 215-46, 331-69, 440-68.
- HODGSON, J. F. 1886. (Continuation of 1884 and 1885 papers). *Arch. J.* xliii, 53-74, 290-305, 403-22.
- KNOWLES, D. and HADCOCK, R. N. 1971. *Medieval Religious Houses in England and Wales*, 2nd. edn. (London).
- MICKLETHWAITE, J. T. 1822. Note in *Arch. J.* xxxix, 457-8.
- MYRES, J. N. L. 1933. 'Butley Priory.' *Arch. J.* xc, 243-58.
- PEERS, C. 1946. *Kirkham Priory, Yorkshire* (H.M.S.O.).
- PEERS, C. 1952. *Portchester* (H.M.S.O.).
- PEVSNER, N. and LLOYD, D. 1967. *Hampshire and the Isle of Wight (The Buildings of England)* (London).
- RENN, D. F. 1972. *Portchester Castle* (H.M.S.O.).
- RADFORD, C. A. R. 1940. 'The Cluniac Priory of St James at Dudley.' *Antiq. J.* xx, 449-59.
- RADFORD, C. A. R. 1952. *Ewenny Priory, Glamorgan* (H.M.S.O.).
- SIMPSON, F. S. W. 1971. *The Churches of St Nicolas, Old Shoreham, and St Mary de Hau(v)ra, New Shoreham*, 4th. edn.
- SWYNNERTON, C. 1921. 'The Priory of Leonard Stanley.' *Archaeologia* lxxi, 199-226.
- WOODWARD, B., WILKS, T. and LOCKHART, C. 1858-69. *A General History of Hampshire*, Volume III (London: n.d. but probably 1858-69).
- ZARNECKI, G. 1953. *Later English Romanesque Sculpture, 1140-1210* (London).

V. BUILDING MATERIALS

ONLY a small quantity of building material was found during the excavation. The largest single deposit was recovered from the filling of gully 9 and must represent rubbish collected from elsewhere, presumably the castle itself, and brought out to level up the ground prior to the erection of the storehouse in 1521-7. It therefore reflects building debris available in the castle in the early years of the sixteenth century. Another, smaller, group found in the priory will have been derived from the refurbished remnants of the western claustral range. Building M1, against the north side of the watergate, also produced slates and ridge tiles with which it was probably roofed. Elsewhere in the area excavation of 1964-72 building material was rare.

LOUVER

(fig. 71)

BY GERALD DUNNING

From the priory, trench P9, layer 16.

Greater part of the top and one side of an aperture, with projecting flange attached to side of the structure. The light red outer surface is entirely glazed green; the inside is not smoke-stained.

The body of the louver was wheel-turned, as shown by rilling marks on the inner surface. The flange was made separately, and then applied by hand; its inner margin partly overlaps the body of the louver.

Near the top of the fragment the structural join has the impression of a cordon passing round the body, as shown in the section. This cordon and the rilling give the approximate slope and size; thus the louver was incurved in profile and about 14 in. (36 cm.) in diameter at the lower part. Cordons dividing the louver into stages or zones, which contain the apertures, are known elsewhere in Hampshire, e.g. at Winchester (Dunning, 1972).

The aperture was triangular in shape and, since its apex and most of one side are present, its size can be determined within limits by duplication and by comparison with other examples. As restored, the opening was about 4.75 in. (12 cm.) high and 4 in. (10 cm.) wide at the base. The flange projects about 1.75 in. (4.5 cm.). On the outer side it is decorated with deep slash-marks, a feature for which no parallel is known on other louvers. The front edge of the flange is marked irregularly by shallow thumb-impressions.

At the summit of the flange the curve continues upwards as a broken stem, showing that the aperture was surmounted by a finial. Only three instances can be quoted of finials in this position on louvers. Two are in the eastern counties; spur finials at the manor of the More, near Rickmansworth, and ovoid finials with terminal knobs at Great Easton, Essex (Dunning, 1966). Roof-fittings were made at the third site, the pottery kilns at Nash Hill, Lacock, Wilts (McCarthy, 1974). Among the pieces of louver is a dome-shaped knob attached above

the flange of an aperture. This provides the most likely parallel for the finials on the Portchester louver, which has been restored accordingly.

Fig. 71 shows the Portchester sherd in front and side views, and in section. This does not necessarily imply that four apertures were present at this level, but the spacing seems right and this number occurs on other louvers. Finally, there is insufficient to decide whether the louver was of type 1 (a separate structure), or type 2 (attached to a ridge-tile), though the latter is better represented in the region. However, its large size suggests that it belonged to type 1, and this is supported by the analogies mentioned above.

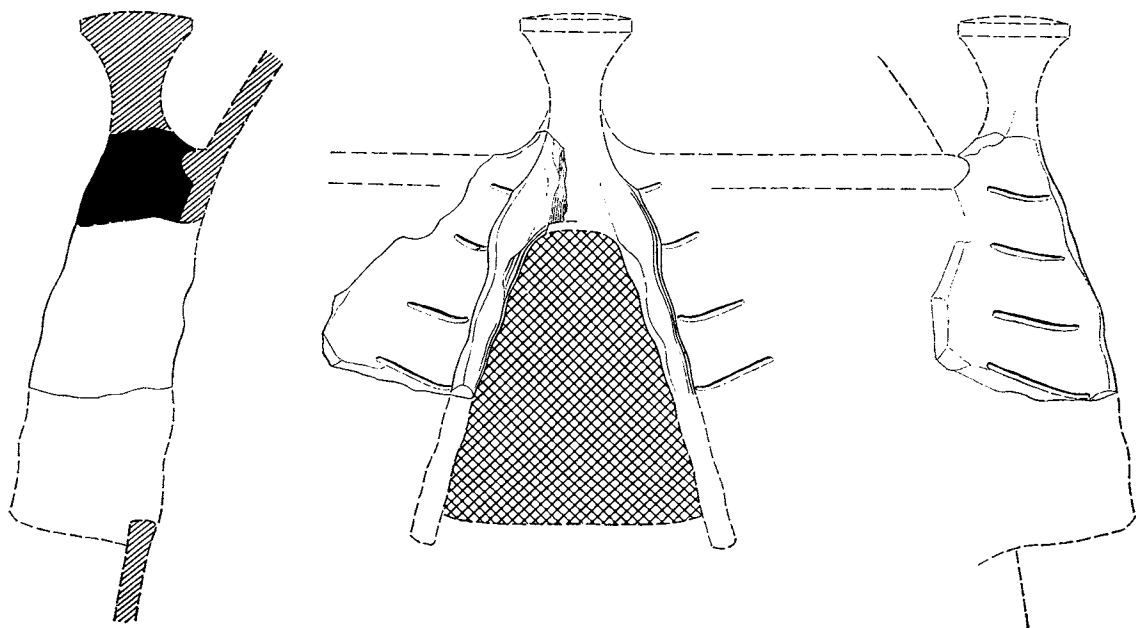

FIG. 71. Restoration of louver (pp. 121-2). Scale $\frac{1}{3}$

CHIMNEY-POTS

(fig. 72)

Fragments of seven chimney-pots were recovered from the excavation: five of them (nos. 44, 73, 142, 160, 178) were from closed contexts, and are accordingly illustrated below together with the rest of the ceramic material from the groups in which they were found. For the sake of convenience they are illustrated again in fig. 72, together with two others (nos. 333 and 334) which were found in general layers.

- 44, from pit 30; thirteenth-century
- 73, from pit 57; twelfth-century.
- 142, from pit 132; thirteenth-century.
- 160, from pit 214; thirteenth-century.
- 178, from gullies 1 and 2; fourteenth-century.
- 333, from trench 89, layer 8.
- 334, from trench 67, layer 3.

All were made in a coarse sandy fabric tempered with flint grits and were fired in an oxidizing atmosphere. Such ornamentation as there was consisted of thumb-impressed strips and jab marks.

Medieval chimney-pots were first discussed in detail by Dunning (1961) and have received further attention on several occasions since then (e.g. Dunning, 1970, for an updating of the

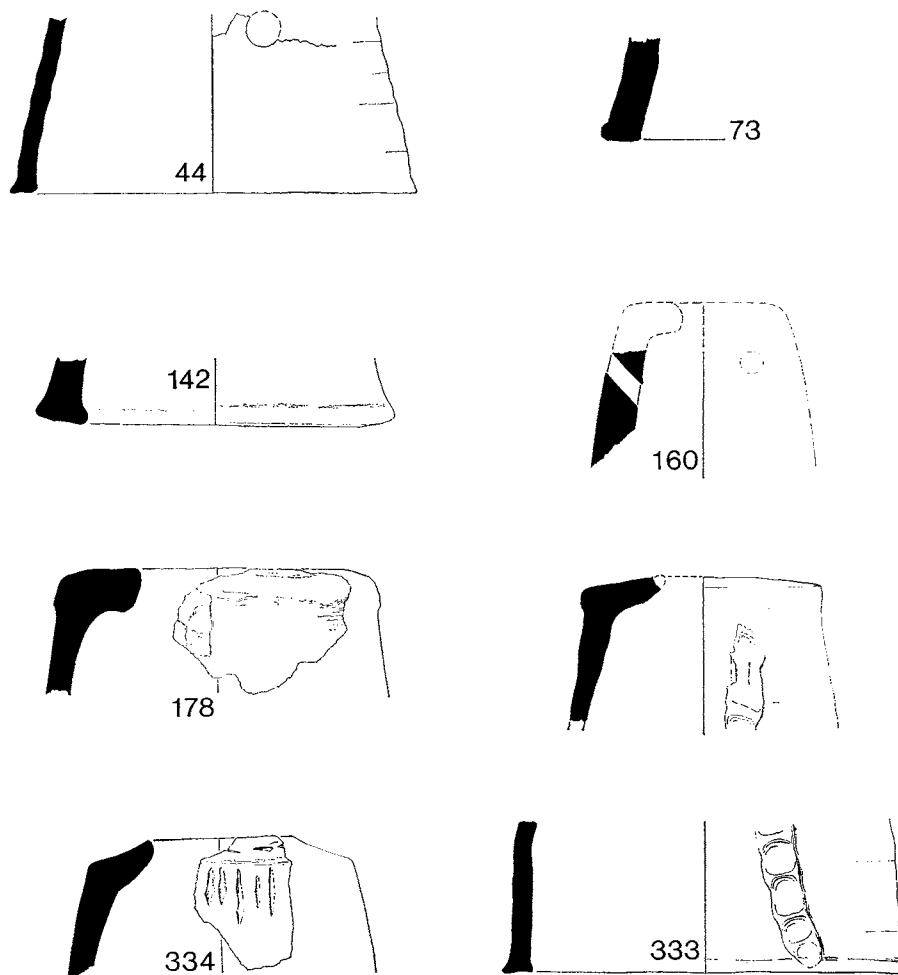

FIG. 72. Chimney-pots (pp. 122-4). Scale $\frac{1}{4}$

original lists). Dunning has emphasized the comparatively large numbers found in Sussex, and has suggested a point of origin in the county, probably in the thirteenth century. It is now known that chimney-pots were made in the kilns at Binstead, Sussex, which were in maximum production in the fourteenth century, and recently a kiln producing chimney-pots among other products, including tiles and pottery, was discovered at Orchard Street, Chichester (Down, 1970) for which Barton, in his discussion of the kiln products, suggests a thirteenth-century date (Barton, 1970). Fragments of chimney-pots are also known from the

material collected from the kiln sites on Wickham Common. The Portchester examples are closely similar to the Chichester and Wickham Common types in both fabric and form. In this context it may be relevant to note that tiles were being transported from Chichester to Portchester by William King in 1324. Evidently the distance was not considered to be too great for this relatively specialized commodity to travel. One chimney-pot from Chichester has been recognized at Southampton (Platt and Coleman-Smith, 1975).

The dates suggested for the Portchester chimneys are largely within the range now generally accepted for examples from other southern British sites, but the specimen from pit 57 (no. 73) is among the earliest known.

ROOF TILES

Roof tiles were very uncommon. Only two examples were found, both from the priory (trench P8, layer 9). They were 14.5 cm. wide and 1.4 cm. thick, but of unknown length. Both were knife cut and were provided with two peg holes.

RIDGE TILES

(fig. 73)

Ridge tiles were relatively plentiful. Their distribution and contexts may be briefly summarized:

Gully 9

Fragments only, of several different types, mostly with knife-cut crests, but some with the crests finger-moulded. Several were deeply jabbed inside below the crest to prevent fracturing during firing. Most were glazed over the crests and some fragments were painted with white bands, in simple geometric designs. The nature of the deposit in which they were found (p. 121) means that the group is of little dating value since it may have contained building rubbish of widely varying date up to the beginning of the sixteenth century.

Priory: east range (trenches P2 and P8)

One complete ridge tile (fig. 73, no. 1) and several fragments.

Priory: west range (trenches P12, P13 and P17)

Two fragments with knife-cut crests.

Building M1 (adjacent to the watergate)

One fragment with knife-cut crests.

Various locations

Fragmentary examples from: trench 95, layer 6; trench 96, layers 14 and 74; trench 97, layer 11; trench 98, layers 6 and 12; and trench 99, layer 49.

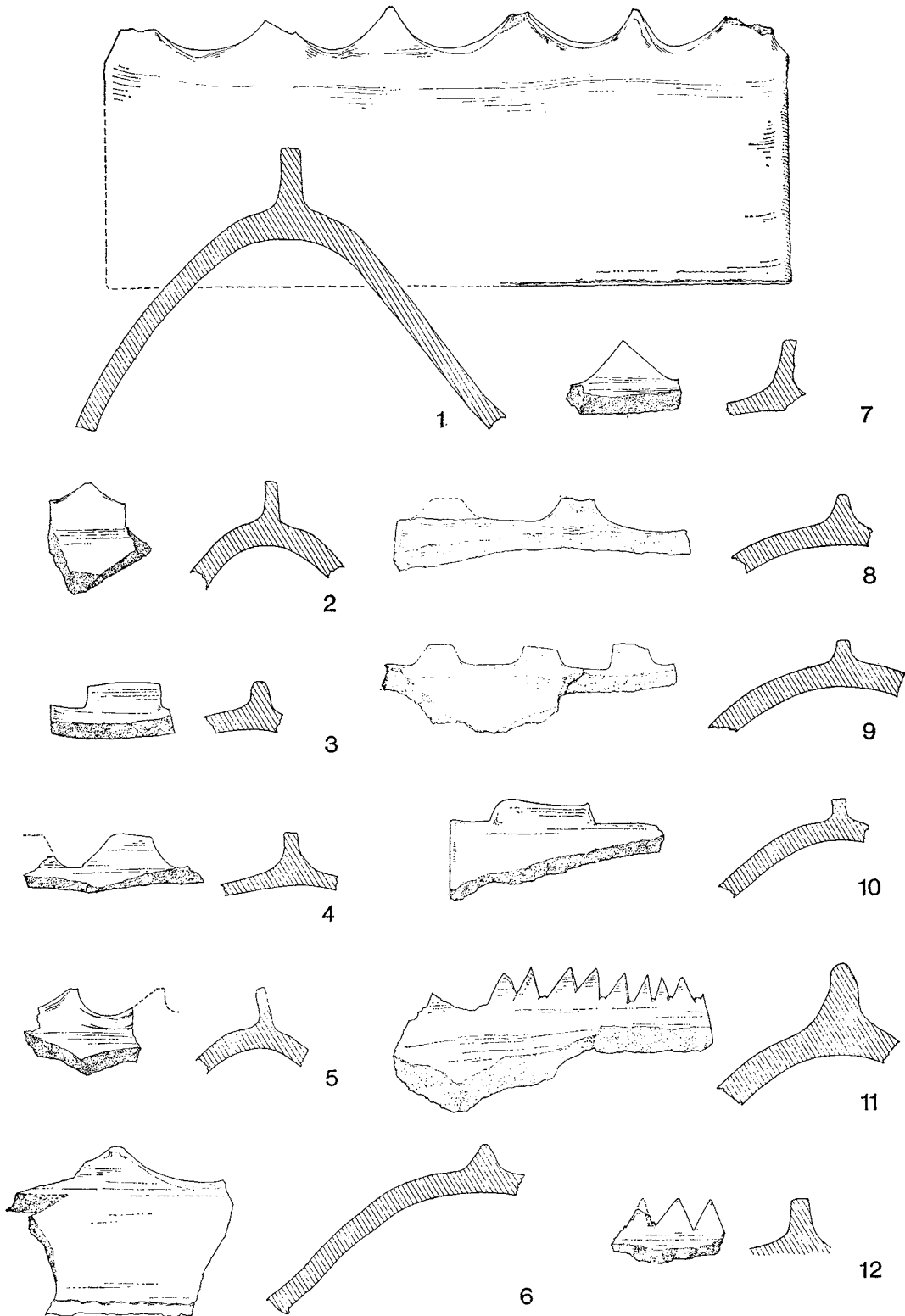

FIG. 73. Ridge tiles (pp. 124, 126). Scale $\frac{1}{4}$

Descriptions of illustrated examples (fig. 73)

All were in hard-fired sandy fabrics, some with a reduced core. Most oxidized throughout.

1. Deep green-brown glaze covering most of exterior. Knife-cut crests with knife stabbing inside beneath crest.
Priory, trench P8, layer 12.
2. No glaze. Careful knife-cut crests.
Trench 96, layer 14.
3. Pale green glaze. Knife-cut crests.
Trench 98, layer 6.
4. Pale green glaze. Knife-cut crests.
Trench 97, layer 11.
5. No glaze. Knife-cut crests.
Trench 96, layer 14.
6. Green-brown glaze over crests only. Crests hand-moulded.
Gully 9.
7. Green glaze. Knife-cut crests.
Gully 9.
8. Thick green-brown glaze. Hand-moulded crests.
Gully 9.
9. Pale green glaze over crests with vertical white lines painted beneath.
Trench 98, layer 12.
10. Discontinuous light green glaze. Knife-cut crests.
Gully 9.
11. No glaze. Tightly cut knife-trimmed crests.
Trench 96, layer 14.
12. No glaze. Tightly cut knife-trimmed crests.
Trench 96, layer 74.

ROOF SLATES

Small fragments of roof slates were found scattered throughout the excavations.

Building M1 (adjacent to the watergate)

Several complete slates from trench 33, layer 2. Widths of 10, 12, 14 and 17 cm. were recorded, with lengths of 19, 21 and 24 cm.

Various locations

Fragmentary examples were found in: pit 30; pit 78; pit 99; trench 60, layer 14; trench 62, layers 9 and 10; trench 73, layer 16; and trench 100, layers 47 and 61.

The slates were up to 0.7 cm. thick and usually of a coarsely laminated light blue slate of West Country origin. They were all roughly cut: a few examples had peg holes surviving.

FLOOR TILES

The only common types of floor tile discovered were square, averaging 12·5 cm across and 2·5 cm thick. They were made from a hard sandy fabric, thoroughly oxidized, and were knife cut. Two varieties of surface finish were represented:

- (a) A white slip covered with a yellow glaze.
- (b) A dark green glaze.

In both cases the glaze was restricted to the one exposed surface.

Tiles of this type were found in the following contexts:

Gully 9

23 fragments of the green type, 21 of the yellow.

Priory: east range

11 fragments of the green type, 11 of the yellow.

In both contexts tiles were found with pottery of the early sixteenth century although, of course, the tiles could be earlier.

An unglazed type of tile of unknown size with deep stab marks in the underside was also represented by one fragment from gully 9 and two from the priory east range.

BRICKS

A single brick was found in gully 9: it measured 11 by 22 cm. and was 4·5 cm. thick.

STONE MOULDINGS

(fig. 74, pl. XLIV)

1. Columnar moulding from door or window.
Priory, trench P2, layer 5.
2. Columnar moulding from door or window.
Priory, trench P2, layer 12.



FIG. 74. Stone mouldings (pp. 127-8). Scale $\frac{1}{2}$

3. (Pl. XLIV*a*). Fleur-de-lis carved both sides.
Priory, trench P₂, layer 5.
4. (Pl. XLIV*b*). Block from arch decorated with Vs each with a small ball terminal. Early twelfth-century, closely comparable to the decoration of the main west door of the church (p. 108, pl. XXVIII*b*) and the arch in the east wall of the north transept, (p. 111, pl. XXXIII*a*).
Priory, trench P₁₄, layer 2.
5. Block from an arch decorated in chevrons. Twelfth-century.
Built into the footings of the sixteenth-century storehouse.

WALL PLASTER

(pl. XLIII*a*)

Gully 9 produced quantities of broken wall plaster, most of which had come from carefully surfaced walls. One fragment was inscribed with the word ANNO in good Roman script.

WINDOW GLASS AND LEADING

BY RICHARD MARKS

Approximately 150 fragments of medieval window glass and 12 pieces of its original leading were found amongst the rubbish thrown into gully 9. The former, except for two pieces, are of white, or clear, glass with a marked green tinge. Several have become completely or partly opaque through devitrification in the soil. A number show surface pitting from corrosion caused by weathering whilst in the windows. Several of the pieces are much thicker than the others, and this suggests that we are dealing with the contents of more than one window (there are obvious technical difficulties in leading together two panes of glass of differing thickness, so it is reasonable to assume that each window contained relatively uniform glass).

Most of the glass fragments have no decoration, but 43 show traces of silver staining and dark brown vitrifiable enamel painted designs. All of these except two are pieces of quarries, i.e. diamond-shaped panes. The painted designs are decorative and similar examples have previously been published (Franks, 1849, pls. 52-4).

Of the other two pieces with painted decoration, one is of blue glass and has a diaper pattern, but it is not possible to identify its context. The other is in what is termed heraldically a cross paty shape and is silver-stained. It may have formed part of a charge on a shield of arms, but equally it could have come from a cross-staff as held by an archbishop or by such figures as the Resurrected Christ, St Margaret of Antioch or St John the Baptist (e.g. Rushforth, 1936, figs. 47-8, 155, 27). The piece thus establishes that the windows did not consist just of quarries, but included figures and/or shields of arms. In terms of domestic glazing in royal palaces and castles both are possible; examples are recorded as early as King Henry III's reign (Borenus, 1943, pp. 47-9).

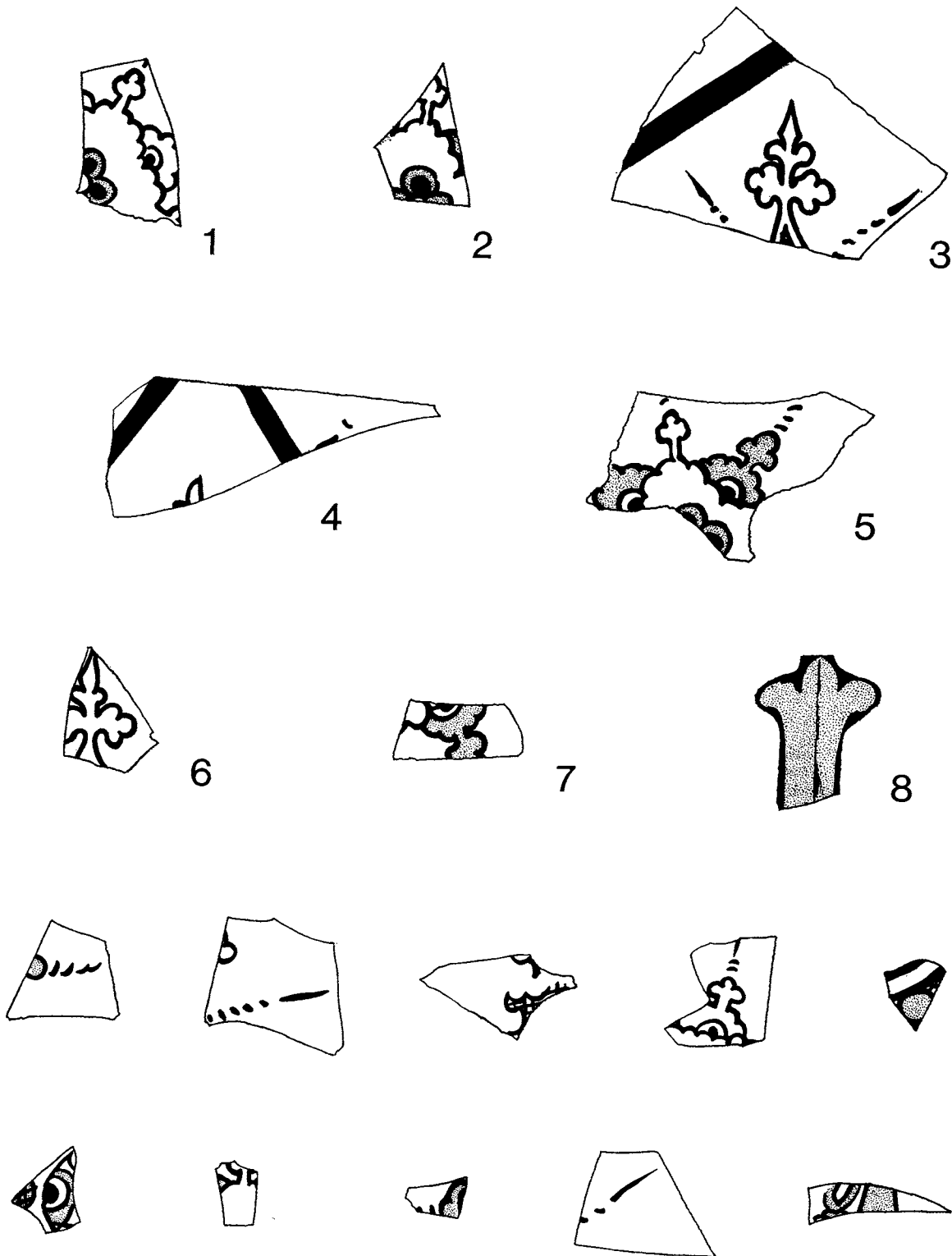

FIG. 75. Window glass (pp. 128, 130). The lower two rows represent a selection of miscellaneous fragments of less diagnostic type. Scale $\frac{1}{2}$

There is also documentary evidence for the use of heraldic glass at Portchester. It is known that glazing work was carried out in the castle in the period June 1398 to August 1399. 216 ft. of glass decorated with shields, badges and borders was bought at the rate of 1s. 2d. per foot for the windows of the hall, great chamber and lower chamber beneath it, the chapel, the exchequer and adjacent upstairs chamber, and for the gallery or passage of the kitchen. 5 ft. of plain glass was purchased at 1s. per foot for the windows over the passage of the great chamber (Brown, Colvin, Taylor, 1963, pp. 790-1). The shields and badges would very probably have been set against quarry backgrounds, and it is tempting to associate the excavated fragments with these accounts. If they are indeed of this period, these quarries would appear to be the earliest examples bearing this type of decoration yet recorded. On the other hand, as no firmly dated quarries of this type have been found before the early fifteenth century it would be rash, in our present state of knowledge, to assume that the pieces were necessarily part of the glazing work carried out in 1398 and 1399. It can at least be said that none of them appears to be of earlier date.

The most recent of the remaining pieces are of the early sixteenth century and consist of fragments of undecorated roundels.

Descriptions of the Diagnostic Illustrated Fragments
(fig. 75)

1. Fragment of clear glass from the centre of a quarry with a formal pattern in silver stain and dark brown vitrifiable enamel paint.
2. As above.
3. Larger fragment of a quarry with a dark brown vitrifiable enamel painted decoration. The left edge has the 'nibbled' surface where it has been trimmed by a glazier's grozing iron preparatory to leading. The glass shows traces of devitrification.
4. Fragment of a quarry decorated in dark brown vitrifiable enamel paint. One edge is grozed.
5. Fragment from a quarry with a formal pattern in silver stain and dark brown enamel paint. One side is grozed to fit the quarry into window tracery or around a different motif in the glass.
6. Quarry fragment with dark brown vitrifiable enamel decoration.
7. Quarry fragment as no. 6, but with some silver stain. Nearly opaque through devitrification.
8. Fragment of a heraldic charge or a cross-staff, in silver stain and outlined in dark brown vitrifiable enamel. All the edges except one are grozed for leading.

BIBLIOGRAPHY

- BARTON, K. J. 1970. 'The Products (of the Medieval Kiln in Orchard Street).' In Down, A. and Rule, M., *Chichester Excavations I*, pp. 157-63 (Chichester).
- BORENIUS, T. 1943. 'The Cycle of Images in the Palaces and Castles of Henry III.' *J. Warburg and Courtauld Insts.* vi, 40-50.

- BROWN, R. A., COLVIN, H. M. and TAYLOR, A. J. 1963. *The History of The King's Works II: The Middle Ages* (London).
- DOWN, A. 1970. 'A Medieval Kiln in Orchard Street.' In Down, A. and Rule, M., *Chichester Excavations I*, pp. 153-7 (Chichester).
- DUNNING, G. C. 1961. 'Medieval Chimney-Pots.' In Jope, E. M. (ed.), *Studies in Building History*, pp. 78-93 (London).
- DUNNING, G. C. 1966. 'A Pottery Louver from Great Easton, Essex.' *Med. Arch.* x, 74-80.
- DUNNING, G. C. 1970. 'Roof Fittings in Pottery from St John's, Bedford.' *Beds. Arch. J.* v, 85-90.
- DUNNING, G. C. 1972. 'Medieval Pottery Louver from Winchester.' *Antiq. J.* lii, 346-9.
- FRANKS, A. W. 1849. *A Book of Ornamental Glazing Quarries, Collected and Arranged from Ancient Examples* (London).
- MCCARTHY, M. R. 1974. 'The Medieval Kilns on Nash Hill, Lacock, Wiltshire.' *Wilts. Arch. and Nat. Hist. Mag.* lxxix, 97-160.
- PLATT, C. and COLEMAN-SMITH, R. 1975. *Excavations in Medieval Southampton 1953-1969*, Vols. 1 and 2 (Leicester).
- RUSHFORTH, G. McN. 1936. *Medieval Christian Imagery as Illustrated by the Painted Windows of Great Malvern Priory Church, Worcestershire* (Oxford).

VI. THE POTTERY

THE medieval pottery from Portchester is discussed in two sections, the first dealing with the chronological and economic aspects of the collection, the second giving descriptions of the illustrated assemblages. Most of the pottery, which comes from pits and gullies, is considered in full: occupation layers associated with buildings provide smaller groups, while from general layers a selection has been made of types otherwise unrepresented or poorly represented. The pottery recovered from the excavations spans the period from the eleventh to the sixteenth centuries; most periods are well represented with the exception of the fifteenth century, for which finds are sparse.

CHRONOLOGICAL AND ECONOMIC CONSIDERATIONS

(a) *The Establishment of a Ceramic Sequence*

The dating of medieval pottery is notoriously difficult, particularly in the context of a site like the outer bailey of Portchester Castle, where no stratified coins were found and the groups were not associated with historically dated building phases. A sufficient number of closed assemblages were, however, recovered to allow the main trends in the ceramic development of the site to be firmly established. For ease of description six phases have been defined, although it must of course be remembered that ceramic development was a continuous process and each observer-imposed phase merged gradually into the next. A comparison of individual Portchester types with those found on neighbouring sites within the region, where localized sequences have been constructed and groups dated by absolute means, provides sufficient evidence for broad chronological date brackets to be assigned to the proposed Portchester phases. The evidence is, however, coarse-grained and, while the sequence is clear, the framework of dates used here must be regarded as tentative.

1. *The Saxo-Norman Tradition (1000–1100)*

Many pit groups of the Saxo-Norman period have already been published in Volume II, where the main characteristic types have been illustrated and described (Vol. II, pp. 153–94). The most commonly occurring were cooking pots and dishes in a distinctive wheel-made fabric termed *Portchester ware*. In association with these were found large jars decorated with neatly applied grid stamps of a type common in Chichester, green-glazed pitchers and jugs in fabrics approximating to *Winchester ware*, products from the Michelmersh kiln and imported French red-painted ware. Besides these characteristic types there were found cooking pots and socketed-handled dishes made in a fairly soft flint-and-chalk tempered fabric. These cooking pots were hand-made but have sagging bases with sharp base angles and deep finger-grooves at the junction of the rim and body. All of these types could be shown to have been in use at the same time at Portchester, and are known to recur together in similar combinations at sites in Chichester and Winchester. The problem is one of dating.

Although it can be accepted that they were in use during the eleventh century, it is difficult to establish when they began to be produced and when manufacture ceased. It has been argued (Vol. II, pp. 190–2) that the advanced pottery skills represented may have originated in the middle of the tenth century — a view consistent with the dating of the beginning of Winchester ware (Biddle and Barclay, 1974, pp. 149–51), but how many of the products survived the end of the eleventh century it is difficult yet to say. Classic Winchester ware seems to have been replaced by more developed types about 1100 (Biddle and Barclay, 1974, pp. 153–4), and it may well be that the other specialized products of the Saxo-Norman tradition had ceased to be made by this time. The effect, if any, of the conquest of 1066 on ceramic production remains to be assessed.

The conventional date of 1066, used here to separate Volume II from Volumes III and IV, is thus somewhat arbitrary when considering pottery. The criterion adopted has been: if a pit contained freshly broken Portchester wares in a high percentage in relation to other fabrics it was considered in Volume II, whereas if it contained the more generalized hand-made coarse ware types virtually to the exclusion of the more distinctive Saxo-Norman wares, it is discussed in this volume. In practice only four pits have been thus selected, pits 110, 116, 118, 161, all of which contain so little pottery as to be largely insignificant. They could all equally as well be pre-Conquest as post-Conquest. Such a distinction has self-evident limitations, its only advantage being that it accepts the potential existence of a recognizable group of late eleventh-century pottery before the more distinctive early medieval types came into production.

2. *The Early Medieval Tradition (1100–1200)*

Pottery assigned here to the twelfth century differs in almost every respect from that of the Saxo-Norman tradition. It is represented at Portchester by the groups from pits 2, 4, 11, 44, 57, 99, 112, 161, and from the foundation pit for the blocking of the Roman south postern. The ranges of forms and fabrics are so distinctive and restricted that they may be listed in full:

1. *Glazed tripod pitchers*: in sandy fabrics with some flint grits, not always thoroughly oxidized, with patchy light green glazes. The bodies are wide, necks corrugated and the pouring lips simply pulled. The handles are of strap type (e.g. no. 2). One vessel (no. 85) with a distinctive mottled orange and green glaze has a rod handle. This vessel has something in common with the green-glazed Saxo-Norman pitchers from which it may have been derived. Apart from combing and scoring (e.g. nos. 2, 3, 85) two other techniques of decoration were employed; applied white strips (e.g. no. 21) and sgraffito (e.g. nos. 49, 61 and 287).
2. *Unglazed tripod (?) pitchers*: in a coarse hand-made flint-gritted ware similar to that of the contemporary cooking pots. The two nearly complete examples (nos. 1 and 19) give some idea of the body shapes. Handles are strap-like, plain (no. 50) or stabbed (nos. 1 and 70).
3. *Cooking pots*: in a coarse sandy flint-gritted ware. They were invariably round-bottomed and hand-made. The commonest rims are usually simple, but may have a slight finger-groove inside. A few are finger-impressed or faceted: occasionally the rims were flattened on the outer lip. Some vessels were fitted with short tubular spouts (nos. 66 and 86) and neck handles (nos. 17, 23, 87 and 285). The surfaces were always smooth but only very rarely grass-wiped (e.g. no. 15). Two (nos. 65 and 66) were decorated with incised wavy lines like the two unglazed pitchers. One (no. 5) differs from the rest. Its wheel-made sandy fabric is much finer and the vessel is more precisely made. It resembles Portchester ware in certain aspects but is at present unique.

4. *Dishes*: in coarse sandy flint-gritted wares with simple pulled out and finger-impressed rims (e.g. nos. 18, 29, 57 and 72).

This limited range of types recurs in reasonable quantity in nine well-stratified groups, each of which exhibits most of the characteristics listed. Indeed it is a distinct possibility that the sgraffito decorated sherds from pits 44, 57 and the foundation pit at the south postern gate may belong to a single vessel. There can be little doubt, therefore, of the broad contemporaneity of these types.

Some indication of dating is provided by a consideration of the earliest Norman defensive works. It can reasonably be argued that the major works on the outer bailey perimeter had been completed at least by 1150 and possibly a good two or three decades earlier (pp. 5–27). As we have seen, one pottery group comes from the foundation trench for the blocking of the south postern gate, which was no doubt part of this work. Another almost identical group, from pit 2, was sealed by a layer of clay which was probably spread when the Norman landgate was built at this time (p. 18). A single, almost complete cooking pot (no. 288) which clearly belongs to the *early medieval tradition* was found in a layer contemporary with the construction of the gate. Thus, on the evidence available, we may reasonably conclude that the vessels of the *early medieval tradition* were in use by the early years of the twelfth century.

With the exception of the pitcher (no. 85) and cooking pot (no. 5) both of which are reminiscent of the Saxo-Norman ceramic techniques, the contrast between the eleventh-century *Saxo-Norman tradition* and the twelfth-century *early medieval tradition* is very striking. Examination of a range of sites of different social status is required before the significance of this factor can be fully assessed.

3. *The Developed Medieval Tradition (1200–1300)*

Nothing was said above of the upper date limit of the *early medieval tradition*. This is because of the extreme difficulty of dating the gradual changes which can be observed. The basis of the distinction at Portchester is technological. The old gritty fabrics of the hand-made cooking pots were replaced by more even-textured fabrics with far less flint grit. Moreover, wheel-turning now became the norm, with the result that rim profiles were far more tightly moulded than before. Little can be said of the pitchers, except that thumb bases began to replace tripod feet. Strap handles and rilled necks still occurred but several pitchers exhibited plain undecorated necks.

Few large groups of this phase have been found, but limekiln 1 (pits 131 and 132) is of this period, together with pits 190, 208, 214 and 215, and possibly the smaller groups from pits 30, 81, 96, 128 and 172. How they should be dated, however, it is impossible to say except that technologically they are more advanced than the *early medieval tradition* but lack some of the refinements of the *late medieval group* described below. The variety of forms is restricted compared with the later period.

4. *The Late Medieval Tradition (1300–1400)*

The later period is typified by a further noticeable improvement in pottery technology. The cooking pots were now all wheel-made, usually in a very fine sandy fabric, thinly

turned and often fired to light tones of red and ochre. The rims were usually tightly moulded and flattened externally. Larger cooking or storage vessels were also made, liberally decorated with finger-impressed applied strips (e.g. nos. 41, 166 and 289). Little can be said of the pitchers, but the narrow-shouldered baluster type is recorded (e.g. no. 30). Corrugated necks and strap handles continued to be made, but the glazes tended to become darker in tone and more glossy in appearance. At least one example of a face-on-front pitcher is also recorded (no. 210). Other forms now occurred, such as pipkins, costrels (no. 181), socketed-handled dishes and glazed vessels with internally flanged rims (e.g. nos. 177 and 253).

No pit groups of this phase have been found, but the gullies associated with building M2 (i.e. gullies 1, 2, 4, 6, 8 and 19) consistently produced this range of types. As might be expected, the same range was found in occupation layers belonging to building M2, but more loosely stratified and associated with a number of earlier types. From these layers came a small number of imported French types, green-glazed pitchers from north-western France (nos. 263, 270 and 271), a jug from the Rouen region (no. 269), and a red-painted vessel from the north of France (no. 268). Pottery from building M3 is in the same general tradition, but without the range of imports.

Precise dating is again impossible, but the associated French pottery would point to an early fourteenth-century date, perhaps extending back into the end of the thirteenth.

The small group from limekiln 2 falls within this general late medieval category. The vessel no. 272 is of particular interest, since it was fired in such a way as to reduce the surface of the otherwise oxidized fabric to a dark grey colour. This may represent an early example of a technique which became common in the fifteenth and sixteenth centuries. If so, it could indicate a date late in the fourteenth century for the limekiln, which, it has been argued above, may have been built to produce lime for the renovations undertaken in 1369 (p. 59).

5. *The Ultimate Medieval Tradition (1400–70)*

The only group so far found at Portchester which might reasonably be argued to belong to this change-over period is the small collection from the phase 2 occupation of building M1 next to the watergate (pp. 14–16). The few vessels found here (nos. 225–31) are not particularly distinctive and could indeed belong to the fourteenth century, with the exception of nos. 227 and 228, which are of a type found in a late fifteenth- or early sixteenth-century context in Winchester (Cunliffe, 1964, fig. 44, no. 13). All that can safely be said at present is that this group might give some indication of the kind of pottery in use during the first part of the fifteenth century. This deficiency in the Portchester material is to some extent made good by a group found in a cesspit at Chalton, Hants (Cunliffe, 1973, figs. 10 and 11). Here the range included large jugs with strap handles, sometimes painted beneath the glaze with white stripes, bung-hole pitchers, bottles and meat dishes, all of which conform to a general category of wares referred to as *Late West Sussex Wares* by Barton (Barton, 1969a, and Cunliffe, 1973, for brief summary), and dated broadly to the mid fourteenth to mid fifteenth centuries.

6. *The Painted Ware Tradition (1470–1570)*

Gully 9 produced a group of pottery of considerable interest, which had been thrown into the already partially silted gully, along with debris of various kinds, immediately prior to the

construction of a store building which can be dated on historical grounds to 1521-7 (pp. 42-4). A high percentage of the vessels were imports, including a Spanish tin-glazed plate, a Beauvais jug, a Netherlands maiolica jug and a group of Rhenish stone-wares, all consistent with a date in the early sixteenth century. Among the English products were several sherds of Tudor green ware, as well as coarse wares in the form of bung-hole pitchers, jugs with thumbled bases and cooking pots. The coarse wares were characteristically in red sandy fabrics, often deliberately fired to a grey surface which had sometimes been painted with white bands.

A second, more loosely stratified group containing the same range of local wares, together with pipkins, bowls with variously flanged lips and plates, came from the priory site (pp. 101-4). Dating must be less precise, but the similarities to the gully 9 group would suggest that it too must belong in the first half of the sixteenth century.

Painted wares are now well known in southern England. At Tarring, Sussex, a well producing this type of pottery also yielded an unworn Nuremberg jetton of the period 1500-50 (Barton, 1963, pp. 28-31), while from another site in the same village a second group of painted wares was found associated with a worn *soldo* of the Doge of Venice minted between 1478 and 1485 (Barton, 1964, p. 18). Painted wares can, then, be dated with confidence to within the bracket 1470-1550, and may be seen as the logical development of the paint-under-glaze types, of the early fifteenth century, as represented at Chalton.

The duration of the *painted ware tradition* and the nature of its internal developments after the middle of the sixteenth century are problems which lie beyond the present scope of the Portchester material.

(b) *Production Centres, Distribution and Markets*

In our present state of knowledge, there is relatively little that can be said of the kiln sites from which Portchester was served, but it is clear that most of the pottery was of local origin. The Laverstock kilns near Salisbury (Musty, Algar and Ewence, 1969), and the Binstead and Rye kilns of Sussex (Vidler, 1934) appear not to be represented in the Portchester assemblage.

The only kilns so far discovered in the general hinterland of Portchester are the Orchard Street and Southgate Street kilns at Chichester (Down, 1970), and the probable kiln sites on Wickham Common, from which only a surface collection of sherds is at present available. Both centres were producing cooking pots, glazed pitchers, roof tiles and chimney-pots. Barton (1970, pp. 163-4) has suggested a thirteenth-century date for the Orchard Street products, but pottery production around Chichester must have continued throughout the medieval period. The Wickham Common sherds include a high percentage of cooking pots of types which would be classed here as being within the *late medieval tradition* of the fourteenth century: there are, however, cooking pots of earlier appearance. The pitchers, most of which had strap handles, could be of thirteenth- or fourteenth-century date. Wickham Common was ideally suited to serve both Portchester and Portsmouth, as well as the large ecclesiastical establishments at Bishops Waltham and Southwick Priory. The numerous dense scatters of pottery indicate intensive production, possibly spanning several centuries, but until the kilns and their waste heaps have been examined by excavation, details of production and distribution must remain obscure.

Chichester is known to have exported roof tiles to Portchester in the mid fourteenth-century (p. 124), and it therefore remains a possibility that pottery was also imported from this source. Pitchers from the Orchard Street kilns offer close comparisons with some of the vessels from Portchester, but it is impossible by visual inspection alone to be sure that Chichester wares were actually in use in the castle. The Chichester kilns seem to have produced no specialized or highly decorated types, but merely the normal domestic wares. They are therefore unlikely to have competed with the more local kilns such as Wickham Common, which were manufacturing much the same range.

So far we have been concerned only with thirteenth- and fourteenth-century wares. Of the production centres for the twelfth-century wares there is little to be said, except that they could well have been sited in the same area as the later Wickham Common kilns. The forms and fabrics of both the cooking pots and the tripod pitchers seem to be localized in that they differ from those found in the neighbouring towns of Chichester, Southampton and Winchester: local production would therefore seem to be indicated.

The post-medieval painted wares and associated types were so widespread in the south that several centres of production must have been in operation. One, at Knighton on the Isle of Wight, has been excavated (Fennelly, 1969); there is no certainty, however, that the Portchester vessels were derived from here rather than elsewhere.

Among the other English wares of the sixteenth century should be mentioned a small collection of Tudor Green wares (figs. 99, 101, nos. 362-4, 379-85), probably from Surrey, and several vessels in fine light-coloured wares (fig. 101, nos. 388-9) which were probably not local to the castle. Their source has not yet been identified.

(c) *Imported Wares and Status*

Imported wares of medieval date are limited in number at Portchester, in sharp contrast to Southampton where over 30% of the medieval pottery was imported from abroad (Platt and Coleman-Smith, 1975, Vol. 2, 16). The only vessels of foreign origin from the area excavation at Portchester are sherds of three or four green-glazed pitchers of north-western French origin (Barton, 1966*a*, fig. 24), a north French painted jug and a glazed jug of Rouen type (Barton, 1966*b*, fig. 1) (fig. 93, nos. 268-71), all, significantly, found in the vicinity of building M2 in contemporary occupation layers. Elsewhere, from pits, gullies and general layers the pottery was local. It would be tempting, on this evidence, to see the building as one of some status. Comparison with assemblages from the inner bailey, when these are available, may throw some light on the standards of living prevalent in the different areas of the castle.

The sixteenth-century group from gully 9 presents an interesting contrast to the medieval assemblages in that it contained a high percentage of imports, including vessels from the Rhineland, Netherlands, France and Spain (p. 180). It has been argued, however (p. 121), that this material was probably derived from the castle and does not represent occupation in the outer bailey. The contemporary group from the priory east range, on the other hand, produced only one sherd from an imported stone-ware tankard (no. 378) and part of a Beauvais jug (no. 404) in a collection of otherwise southern British types, among which cups, a chafing dish, and a goblet in Tudor Green ware indicate a reasonable standard of affluence.

THE POTTERY IN ITS GROUPS

In the following pages a description is given of all the medieval pottery found in sealed groups, or from other well-defined locations. In each group most of the vessels are illustrated in order to indicate the range of minor variations within each type: the numbers of unillustrated rims are also recorded. Then follows the illustration of a selection of sherds from general, loosely stratified, situations, mainly in the medieval ploughsoil. The two post-medieval groups are considered in the final section.

Description has, it is hoped, been kept to an acceptable minimum. No attempt has been made to quote lengthy lists of parallels nor have tenuous arguments been put forward for the dating of each group. Additional comment is offered only on very distinctive types: all too often general comparisons can be misleading. The description of each group is concluded with a brief comment on its likely chronological range, referring to the above discussion (pp. 132-6) where the main lines of reasoning are displayed.

The value of the collection lies in the reasonably large number of well-stratified groups rather than its exotic types or the fineness of the chronological calibration. No statistical analysis has been attempted here. Such an approach will be worth while only after the groups from the inner bailey have been studied in detail.

*(a) Saxo-Norman and Medieval**Pit 2 (I Pit B) (figs. 76, 77)*

1. Pitcher, with decorated strap handle. The body is ornamented with horizontally arranged wavy lines, shallow-tooled into the leather hard fabric. Grey ware with crushed flint grits: the surfaces are smoothed and fired red.
2. Pitcher, possibly of tripod form, with decorated strap handle. The neck is corrugated and the body scored with horizontal lines. Hard grey sandy ware containing flecks of charcoal. Coated externally with an even apple-green glaze.
3. Pitcher base. Fine grey sandy ware fired red on the surfaces, external knife trimming at the base.
4. Pitcher. Hard pale ochre-grey ware: thick green glaze over scored decoration.

Not illustrated: three sherds from pitchers: all in fine red sandy fabrics with orange-green glaze.

- 5-17. Cooking pots of various types selected from a larger group to display the full range of types and fabrics.
5. Fine, rilled surface and tightly moulded rim. Wheel-turned in fine red-grey sandy ware with occasional flint grits. Spots of dark green glaze on the surface.
- 6-8. Moulded rims, wheel-turned. Red-grey sandy fabrics with sparse crushed flint grits. No. 8 is contorted and has spots of glaze on the surface.
- 9-11. Faceted rims, wheel-turned. Red-grey sandy fabrics with crushed flint grits.
- 12-16. Simple rims, hand-made. Grey ware tempered with copious flint grits. No. 15 has a grass-wiped surface. The rim of No. 16 is slightly grooved internally.
17. Strap handle from a cooking pot or pitcher. Light brown flint-gritted ware.

In addition to the illustrated sherds a further 24 rim sherds survive. Of these 11 conform to the class represented by nos. 6-8, the remainder are simple hand-made rims like nos. 12-16. From the large

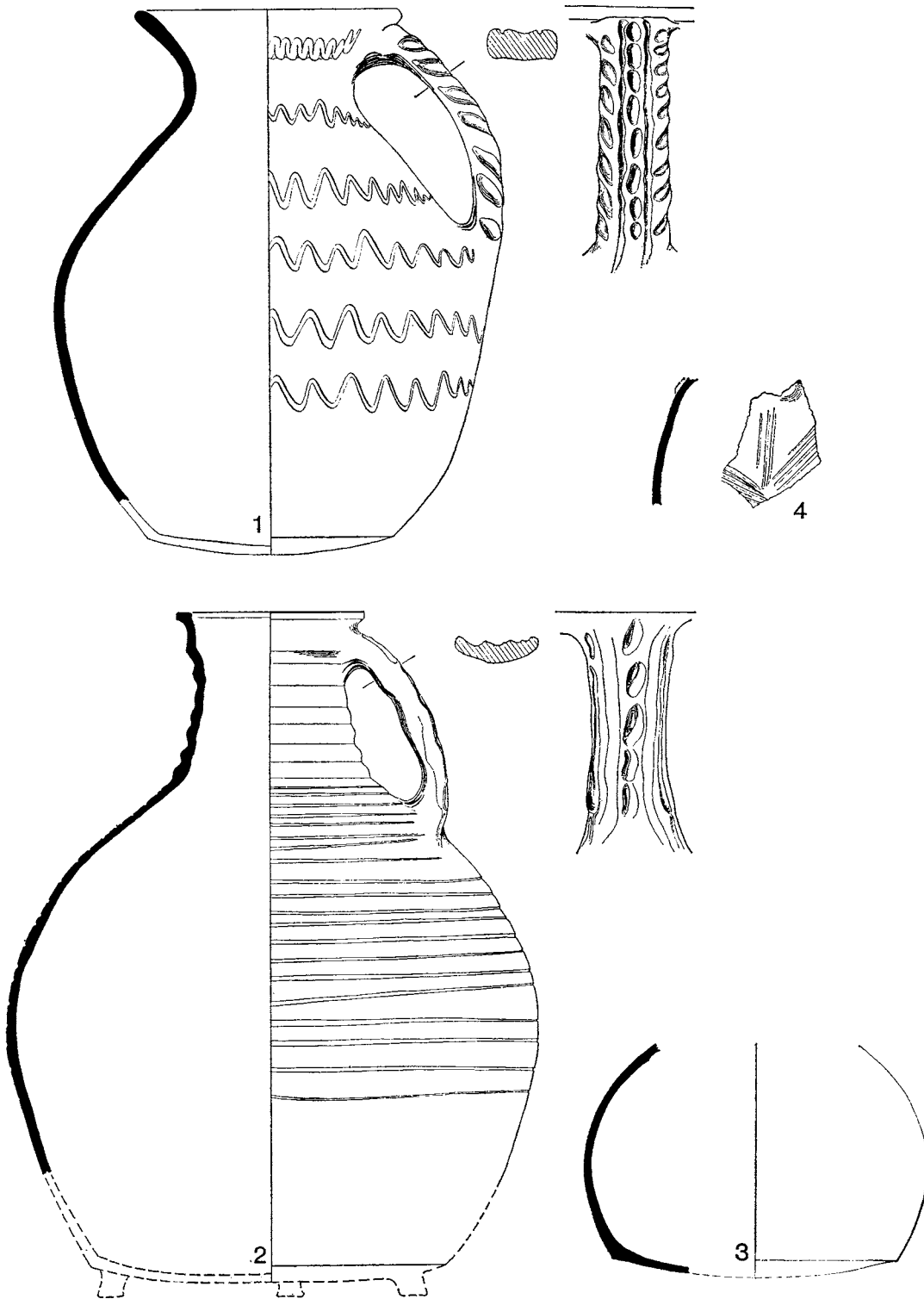

FIG. 76. Pottery from pit 2 (p. 138). Scale $\frac{1}{4}$

EXCAVATIONS AT PORTCHESTER CASTLE

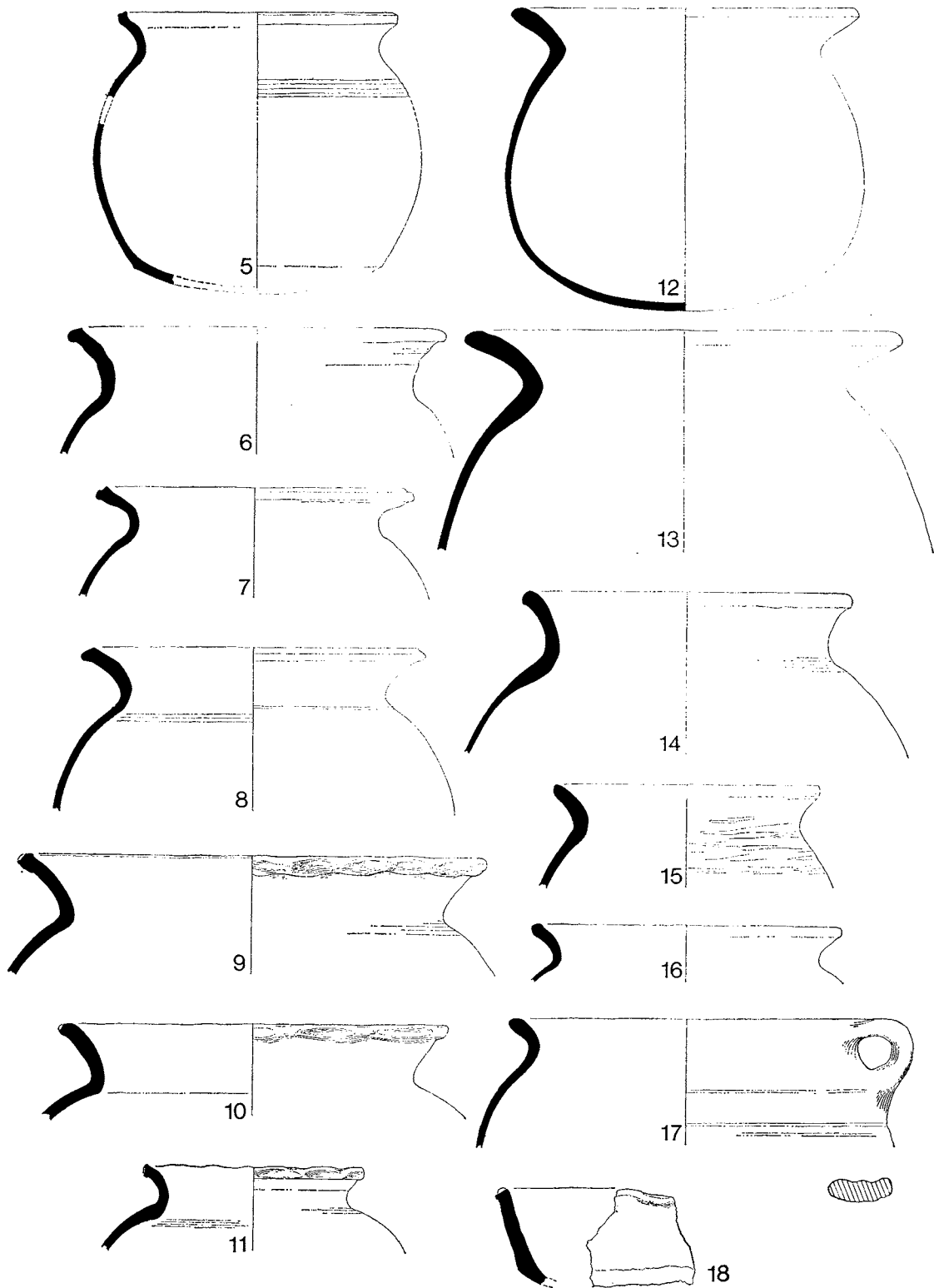

FIG. 77. Pottery from pit 2 (pp. 138, 141). Scale $\frac{1}{4}$

number of body sherds it is clear that most of the cooking pots had rounded bases: only two had sharp base angles and sagging bases.

18. Dish with pie-crust rim. Grey-brown sandy ware with copious flint gritting.

Early medieval tradition: twelfth-century. The pit was sealed by a clay layer which probably dates to the construction phase of the landgate in the first half of the twelfth century; cf. group from foundation trench for south postern blocking wall.

Pit 4 (1 Pit D)

Not illustrated: two cooking pot rims of simple type in hand-made flint-gritted ware (cf. nos. 12-16) and one cooking pot rim of moulded type (cf. nos. 6-8) in a wheel-made sandy fabric with flint grits.

Early medieval tradition: twelfth-century.

Pit 6 (2 Pit C)

Not illustrated: a few cooking pot body sherds.

Date uncertain: twelfth- to thirteenth-century.

Pit 8 (2 Pit E)

Not illustrated: a few cooking pot body sherds.

Developed medieval tradition: thirteenth-century.

Pit 11 (3 Pit C) (fig. 78)

19. Pitcher decorated in horizontal zones with wavy lines, shallow tooled into the leather hard fabric. Greyish ware tempered with flint grits, fired red on the surface. Hand-made?
20. Pitcher?, fine grey sandy ware fired light brown on the surface.
21. Foot from a tripod pitcher. Coarse flint-gritted ware fired light red.
22. Pitcher sherds. Grey sandy ware fired red on the internal surface. Externally the vessel was decorated with bows of white paste before an overall green glaze was applied.
- 23-8. Cooking pots of various types. All were in grey-brown sandy fabrics tempered with flint grits. No. 23 has a small neck handle, the rim to pot no. 24 was flattened and the vessel was wheel-made. The others were hand-made. Not illustrated are 10 cooking pot rims, of which one resembled no. 24. The rest were simple.
29. Dish with pie-crust rim. Reddish-grey sandy ware with flint grit tempering.

Early medieval tradition: twelfth-century.

Pit 30 (28b, layers 2, 3, 4; 91, layers 8, 15, 74-6) (fig. 79)

30. Pitcher. Hard grey sandy ware with brownish-green glaze. 28b, layer 2b, and 91, layer 15.
31. Tripod pitcher base. Fine red sandy ware with splashes of orange glaze. Some knife trimming around the base. 91, layer 15.
- 32-4. Cooking pots with simple rims. Hand-made in grey flint-gritted wares. No. 33 has a neck handle. 32 from 91, layer 8; 33 from 28b, layer 2b; 34 from 91, layer 75.

Not illustrated: three similar rim fragments.

EXCAVATIONS AT PORTCHESTER CASTLE

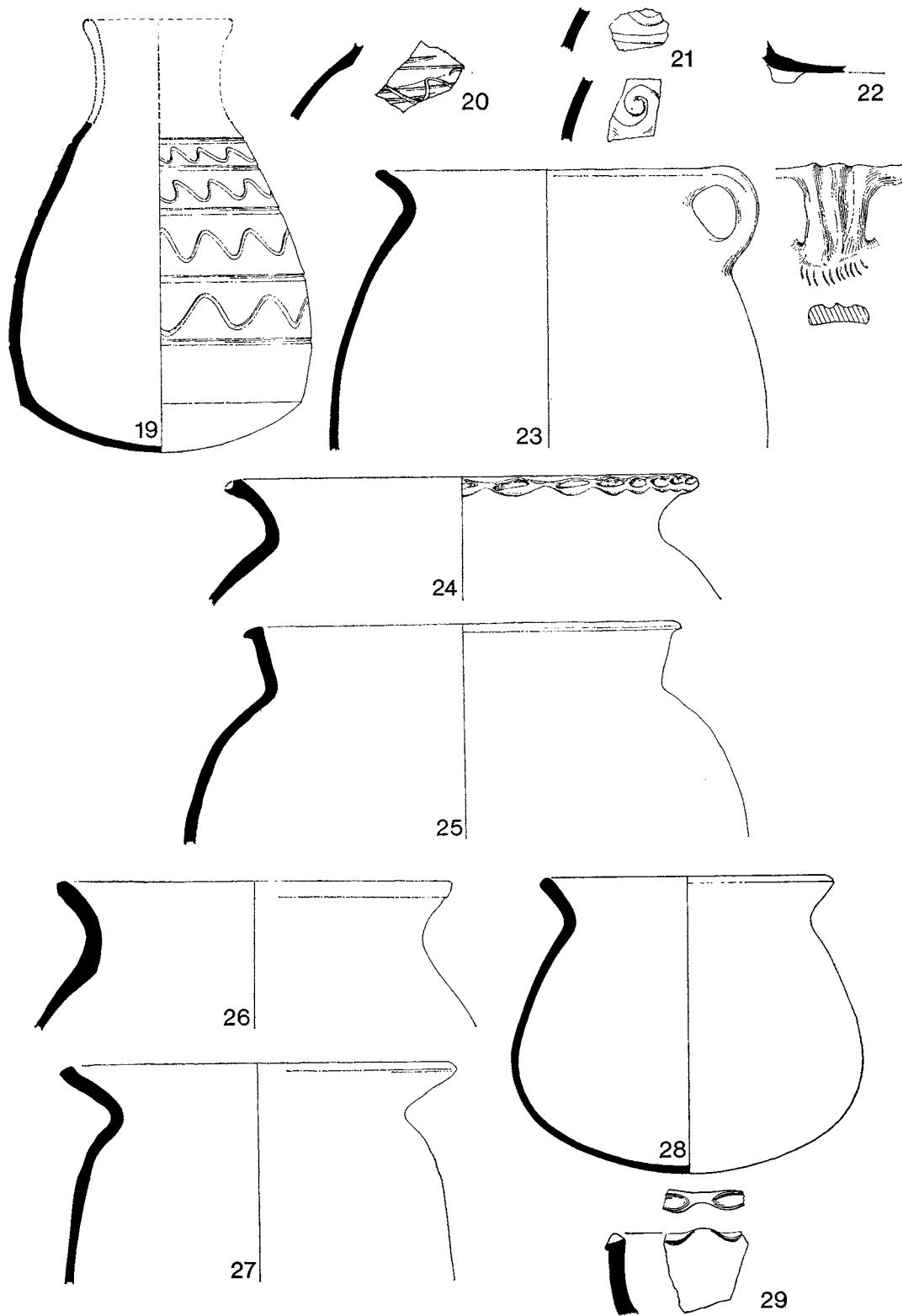

FIG. 78. Pottery from pit 11 (p. 141). Scale $\frac{1}{4}$

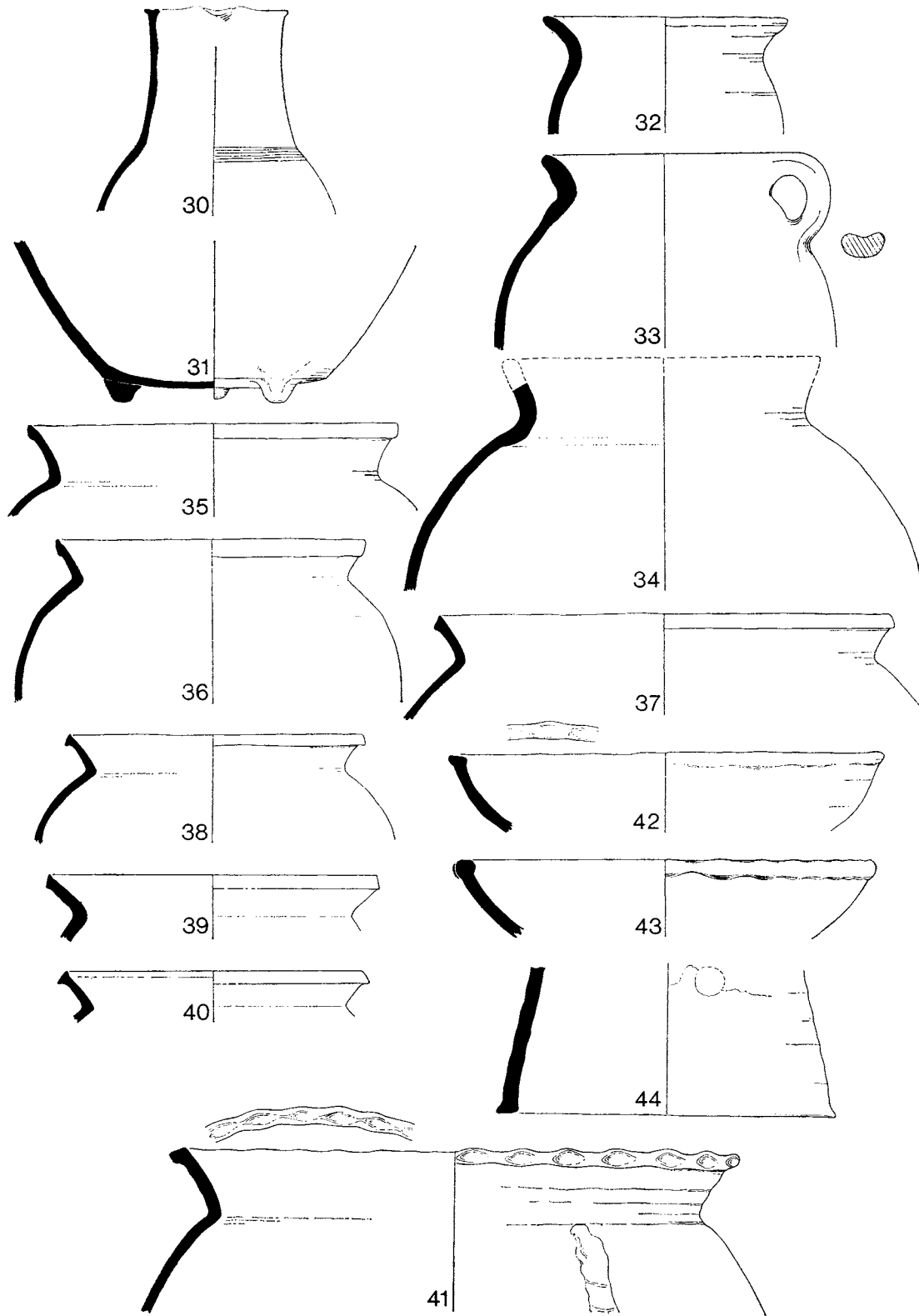

FIG. 79. Pottery from pit 30 (pp. 141, 144). Scale $\frac{1}{4}$

- 35-40. Cooking pots with collared rims. Wheel-turned. All in fine hard sandy wares fired to red or grey-brown. All have sparse flint grits in varying quantities. No. 36 is almost grit-free; no. 37 has some water-worn flint grits; the rest have occasional grits of crushed flint. From the body sherds it is probable that all the vessels were round-bottomed.
35 from 91, layers 15 and 74; 36 from 91, layer 15; 37 and 38 from 91, layer 76; 39 and 40 from 28b, layer 2b.
41. Cooking pot. Wheel-made in grey sandy ware with fine flint grits, fired dark grey on the surface. Pinched rim and with applied pie-crust strip on the body. Odd spots of glaze.
91, layer 75.
- 42-3. Dishes with pie-crust rims in grey sandy wares with flint grits: fired red internally.
42 from 91, layer 76; 43 from 28b, layer 2b.
44. Chimney-pot. Wheel-made in grey sandy ware with fine water-worn flint grits: fired red on the surface.
91, layer 15.

Developed medieval tradition: thirteenth-century.

Pit 31 (37 Pit A) (fig. 80)

45. Cooking pot. Simple rim. Grey sandy ware with flint grits fired red and black externally.

Developed medieval tradition?: thirteenth-century.

Pit 44 (62, layers 16 and 17) (fig. 80)

46. Pitcher with strap handle. Fine light red sandy ware with thick green speckled glaze.
Layer 16.
47. Pitcher with ornamented spout broken off. Fine buff sandy ware with thick green speckled glaze.
Layer 16.
48. Pitcher with corrugated neck. Fine buff sandy ware with orange-brown glaze.
Layer 16.
49. Pitcher decorated in sgraffito technique. Fine red-grey sandy ware coated with an external white slip through which wavy lines have been scratched before the application of a thin yellow-green glaze.
Layer 16. Same as no. 61 from pit 57.

Not illustrated: 11 body sherds of glazed pitchers similar to nos. 46-8.

50. Handle of pitcher? Hard grey sandy ware with some flint grits.
Layer 16.
- 51-5. Cooking pots. Wheel-made except for no. 55. All in sandy wares with crushed flint grit tempering fired to dark red-brown or black. No angled bases are present among the body sherds. In addition to those illustrated five additional rims are recorded of similar type.
51 from layer 17; 52-5 from layer 16.
56. Small cooking pot in fine red sandy ware. Speckles of orange-green glaze.
Layer 16.
57. Dish with pie-crust rim. Grey sandy ware with crushed flint grit tempering: wheel-made.
Layer 16.

Early medieval tradition: twelfth-century. The sgraffito decorated sherd no. 44 may be part of the same pot as the sherds from pit 57, and those from the foundation pit for the south postern blocking wall.

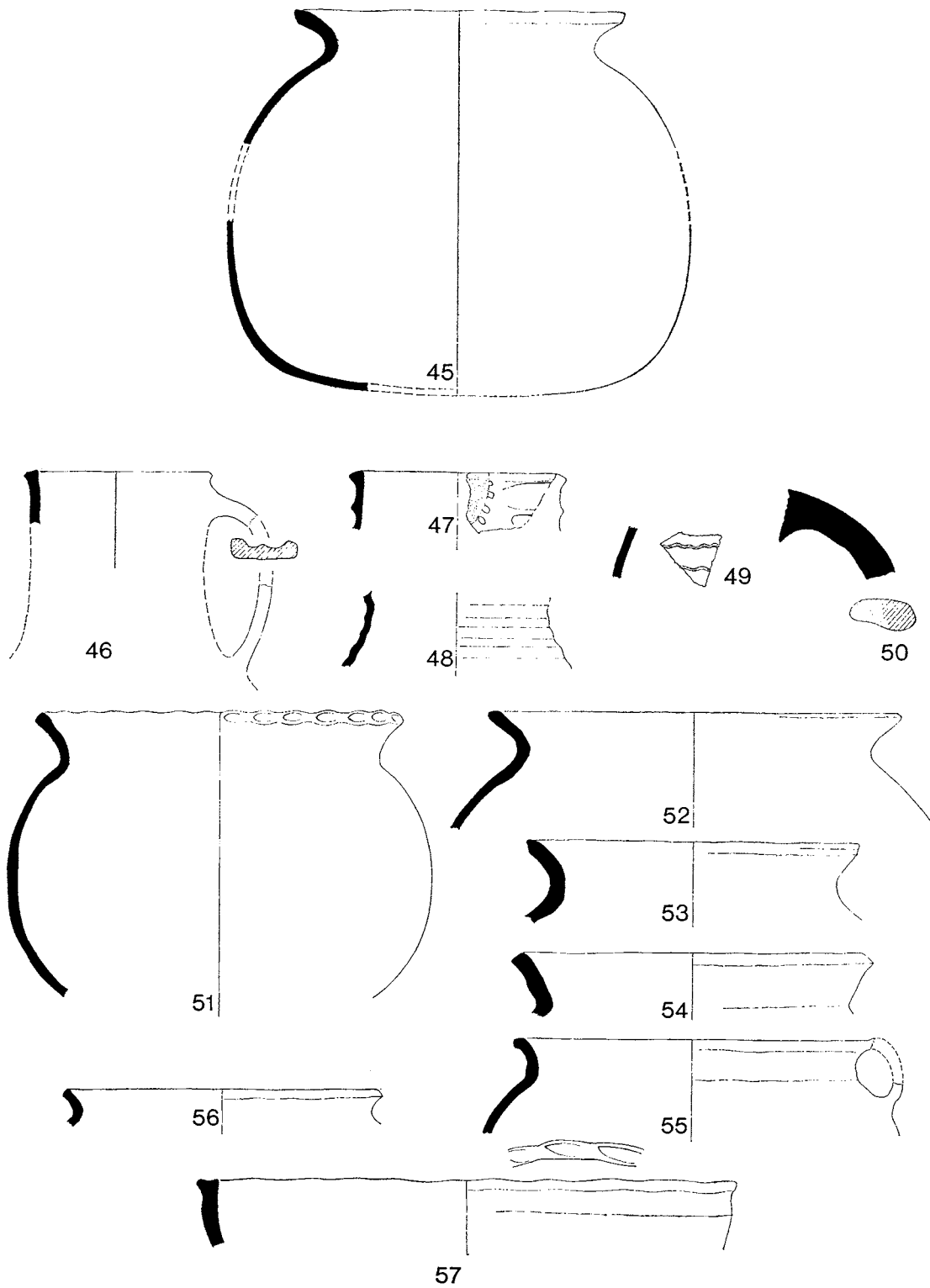

FIG. 80. Pottery from pit 31 (no. 45); pit 44 (nos. 46-57) (p. 144). Scale $\frac{1}{4}$

Pit 57 (67, layers 9, 26, 32, 33, 34, 35, 36) (fig. 81)

58. Pitcher, with corrugated neck in hard red sandy ware with orange glaze speckled with light green.
Layer 26.
59. Pitcher, in light red sandy ware with dark-green glaze.
Layer 9.
60. Pitcher, hard grey sandy ware with light greenish-brown glaze.
Layer 9.
61. Pitcher fragments decorated in sgraffito. Fine red-grey sandy ware coated with an external white slip, through which the decoration was scratched before the application of a thin yellow-green glaze. Same vessel as no. 49 from pit 44.
Layer 9.
- 62-9. Cooking pots. Wheel-finished with round bases. Hard sandy ware tempered with flint grits, fired grey or grey-brown. Several are blackened externally by use. Two, nos. 65 and 66, are decorated with wavy lines; the rims of nos. 65 and 67 are pinched, the rims of nos. 62 and 63 are slightly grooved internally. Sixteen plain cooking pot rim sherds are not illustrated. All from layer 26, except 66, which is from layer 32.
70. Decorated handle. Grey flint-gritted ware fired light red on the surface.
Layer 26.
71. Vessel with high neck. Grey flint-gritted ware, hand-made.
Layer 26.
72. Dish with pie-crust lip. Grey-brown flint-gritted ware, fired red on the surface.
Layer 9.
73. Chimney or curfew. Coarse flint-gritted ware fired red.
Layer 9.

Early medieval tradition: twelfth-century. The sgraffito decorated sherd, no. 61, may belong to the vessel found in pit 44 and the trench for the south postern gate blocking wall.

Pit 75 (71, layer 12)

Not illustrated: one fragment of a simple cooking pot rim, in grey-brown flint-gritted ware.
Date uncertain: twelfth- or thirteenth-century.

Pit 81 (73, layers 40, 49) (fig. 82)

- 74-5. Dishes, one with a pie-crust rim. Both in hard sandy wares with some flint grits. No. 74 is fired black, no. 75 is fired to a pinkish grey colour.
Layer 40.
- 76-7. Cooking pots. Wheel-turned in grey sandy ware with some flint grits. No. 76 is fired to a buff-brown colour.
Layer 40.
78. Pitcher with slashed strap handle. Grey sandy ware with deep green glaze.
Layer 40.

Not illustrated: strap handle of a pitcher with pale green glaze.
Developed medieval tradition: thirteenth-century.

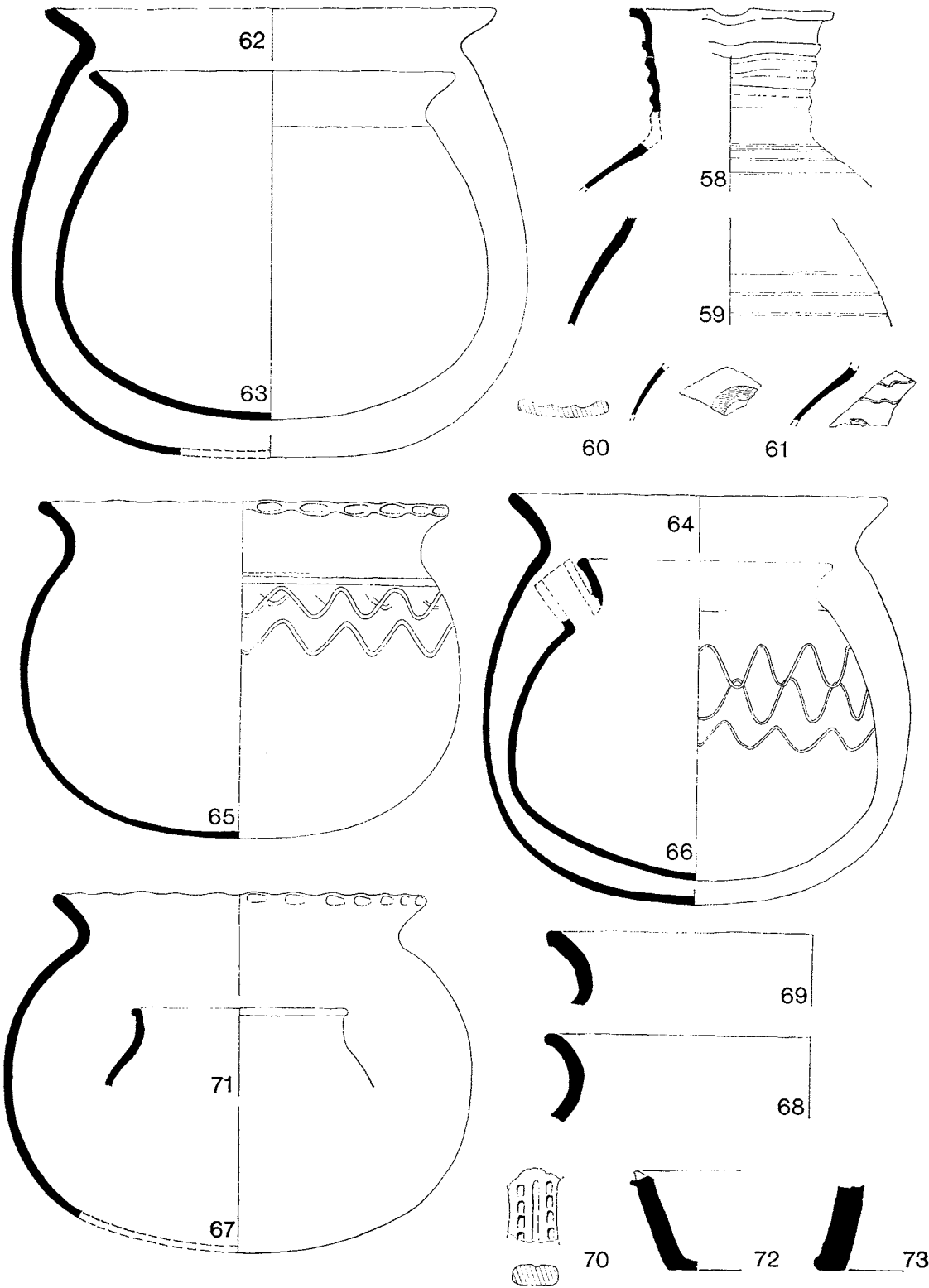

FIG. 81. Pottery from pit 57 (p. 146). Scale $\frac{1}{4}$

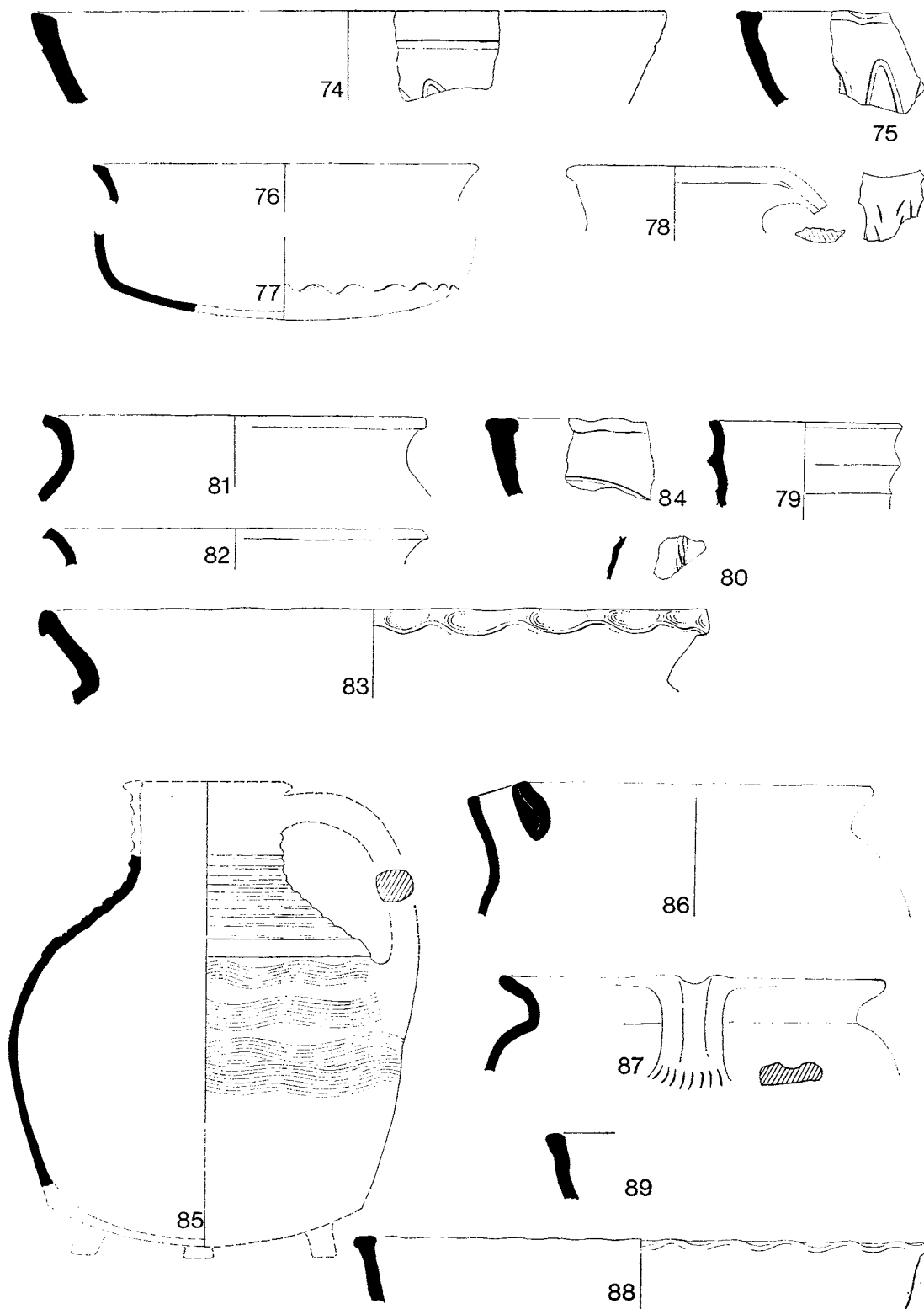

FIG. 82. Pottery from pit 81 (nos. 74-8); pit 96 (nos. 79-84); pit 99 (nos. 85-9) (pp. 146, 149).
Scale $\frac{1}{4}$

Pit 96 (76, layers 8, 31) (fig. 82)

79. Pitcher. Fine buff sandy ware with green-brown glaze.

Not illustrated: one strap handle and two body sherds from glazed pitchers (layer 8).

80. Pitcher fragment. Fine hard white sandy ware with an even dark green glaze. French import. Layer 8.

81. Cooking pot. Wheel-turned. Dark grey sandy ware. Layer 8.

82. Cooking pot. Wheel-turned. Fine pinkish sandy ware with odd spots of orange glaze. Layer 8.

Not illustrated: a sherd of similar but larger vessel.

83. Large cooking or storage vessel. Wheel-turned with pinched rim. Grey sandy ware fired pinkish, with large flint grits. Layer 8.

84. Dish with pie-crust rim. Wheel-turned. In grey-brown finely flint-gritted fabric. Layer 8.

Developed medieval tradition: thirteenth-century.

Pit 99 (75, layers 6, 32-41, 46-8 (figs. 82, 83)

85. Pitcher, possibly of tripod type, with corrugated neck and rod handle. Below the shoulder cordon the body has been decorated by combing. A comb has also been jabbed into the outer face of the handle. The fabric is fine, light grey and sandy. The outer surface is coated with a streaky orange and apple green glaze. Layer 47.

86-7. Two sherds, possibly from the same spouted cooking pot. The base of both the spout and the neck handle are decorated with thumbnail impressions. Hand-made grey-brown sandy ware tempered with flint grits. Layer 46.

88-9. Dishes in grey-brown flint-tempered ware. Both are wheel-turned. No. 88 has a pie-crust rim. 88 from layer 34, 89 from layer 38.

90-8. Round-based cooking pots with simple or slightly moulded rims. Grey sandy ware with crushed flint grits fired to a range from brown to grey. Hand-made, but ?wheel-finished. The slight grooving just inside the rim is characteristic. From layer 46, except 96 which is from layer 32 and 97 which is from layer 41.

Early medieval tradition: twelfth-century.

Pit 100 (77, layers 6, 22, 23) (fig. 84)

99-102. Cooking pots with simple rims, some slightly grooved internally. All in grey-brown sandy ware with flint grit tempering. 99 and 102 from layer 6; 100 and 101 from layer 23.

Early medieval tradition?

Pit 105 (77, layer 31)

Not illustrated: body sherds of cooking pots in grey sandy ware tempered with flint grits.

Date uncertain: *early medieval tradition* or *Saxo-Norman*.

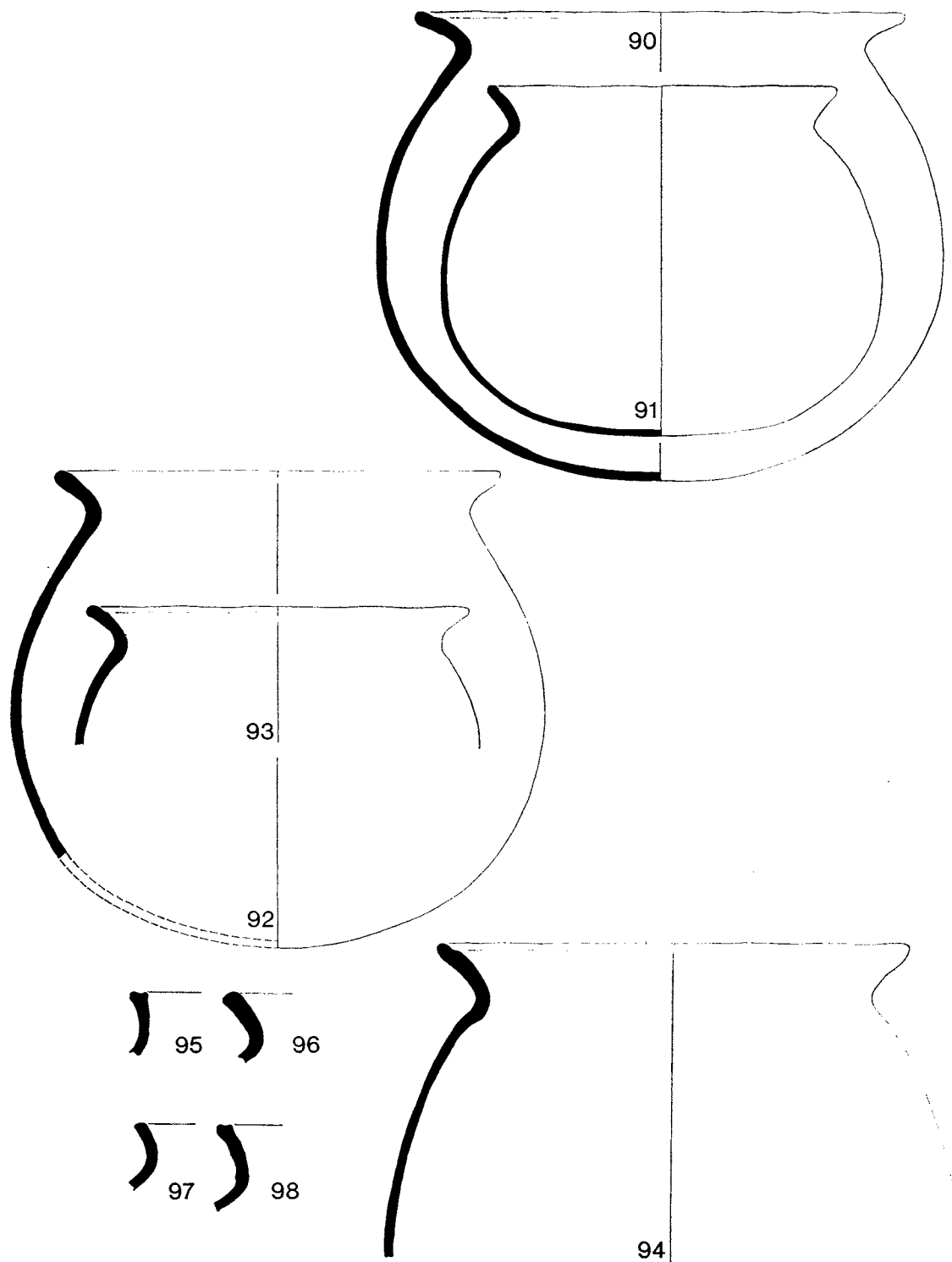
FIG. 83. Pottery from pit 99 (p. 149). Scale $\frac{1}{4}$

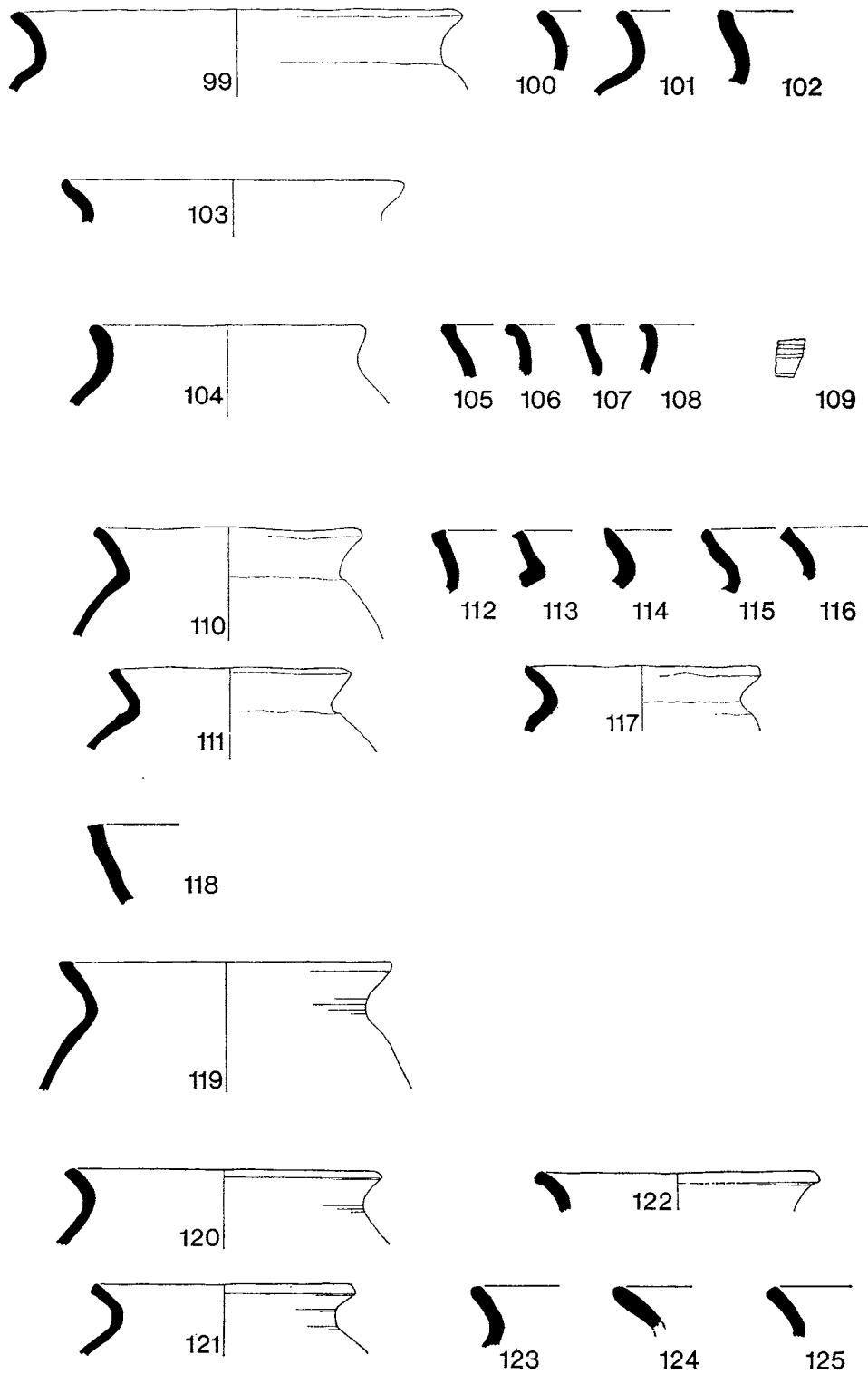

FIG. 84. Pottery from pit 100 (nos. 99-102); pit 110 (no. 103); pit 112 (nos. 104-9); pit 116 (nos. 110-17); pit 118 (no. 118); pit 128 (no. 119); pit 131 (nos. 120-5) (pp. 149, 152-3). Scale $\frac{1}{4}$

Pit 108 (79, layer 11, 24, 25, 38, 39, 40)

Not illustrated: body sherds of cooking pots in grey-brown sandy ware tempered with flint grits.
Date uncertain: *early medieval tradition* or *Saxo-Norman*.

Pit 110 (79, layers 34, 42, 43) (fig. 84)

103. Cooking pot in dark grey sandy ware with flint tempering.
Layer 34.

Not illustrated: body sherd of pitcher in light grey sandy ware fired red with patchy orange-green glaze.

Date uncertain: *early medieval tradition* or *Saxo-Norman*.

Pit 112 (79, layers 6, 30, 31, 35) (fig. 84)

104-8. Cooking pots of various rim forms. Nos. 106-8 are in the smooth fabric with flint grits typical of Late Saxon Portchester ware. They may therefore be regarded as rubbish survival. Nos. 104 and 105 are in grey sandy ware with flint grits.

Layer 31.

109. Pitcher sherd decorated in sgraffito: fine grey sandy ware coated with white slip, through which the decoration has been scratched. Covered with a thin green glaze.

Layer 31.

Early medieval tradition: twelfth-century.

Pit 114 (73, layers 32, 54)

Not illustrated: several rims of late Saxon Portchester ware together with body sherds typical of the medieval cooking pot, sandy fabric with flint grits. Three rims with squared tops in grey ware with flint grits.

Saxo-Norman: eleventh-century.

Pit 116 (80, layers 55, 62, 63) (fig. 84)

110-17. Cooking pots. No. 114 is in sandy ware with flint grits similar to the typical medieval fabric. There are also body sherds in this ware. The remainder are similar in forms and fabric to late Saxon Portchester ware.

110, 112-14 from layer 55; 111, 115-17 from layer 63.

Saxo-Norman: eleventh-century.

Pit 118 (80, layers 30, 49-52) (fig. 84)

118. Dish in grey sandy ware with flint grits, fired red-brown on the surfaces.
Layer 30.

Not illustrated: several large body sherds of a round-bottomed cooking pot in pinkish-buff sandy fabric with large flint grits. The surface is roughly decorated with shallow tooled lines defining pendant triangles.

Early medieval tradition: twelfth-century.

Pit 120 (80, layers 66, 67, 68)

Not illustrated: body sherds of cooking pots in medieval fabrics. Several sherds of Portchester ware. *Saxo-Norman* or *early medieval tradition*: eleventh- or twelfth-century.

Pit 123 (79, layer 16)

Not illustrated: sherd of wheel-turned cooking pot in grey sandy ware with flint grits. The surface is coated by a dribble of green glaze. Also a small sherd of green-glazed pitcher decorated with applied white bands beneath the glaze.

Early medieval or *developed medieval tradition*: twelfth- or thirteenth-century.

Pit 125 (82, layer 18)

Not illustrated: two body sherds of medieval cooking pots.
Date uncertain.

Pit 126 (87, layer 21)

Not illustrated: rim fragment of cooking pot in grey sandy flint-gritted ware.
Date uncertain.

Pit 127 (87, layer 37)

Not illustrated: body sherd in medieval cooking pot fabric, grey sandy ware with flint grits.
Date uncertain.

Pit 128 (87, layer 38) (fig. 84)

119. Cooking pot with moulded lip, grey sandy ware with flint grit tempering.
Date uncertain.

Pit 131 (89, layers 31, 31a, 56, 62, 63, 64) (fig. 84)

120-5. Cooking pots. All wheel-turned in grey-brown sandy ware tempered with flint grits.
Layer 31.

Developed medieval tradition: thirteenth-century.

Pit 132 (89, layers 32, 57-9, 61, 70) (fig. 85)

126-35. Cooking pots. Mainly wheel-turned in grey sandy wares with some flint grits: fired to grey or reddish brown. 130 has a squared faceted rim, 131 appears to be hand-made, 133-5 have finger-impressed rims.

Nos. 126 and 130 from layer 58; 127-9 and 134 from layer 32; 131-3 from layer 57; 135 from layer 61.

Not illustrated: 10 rims of simple form, 10 squared-off and two faceted.

136-9. Pitchers. 136 in fine grey sandy ware fired red on the surface; 137 and 138, light red sandy ware with green-orange mottled external glaze, 139 fine grey sandy ware with traces of greenish brown glaze, with finger impressions.

Nos. 136 and 138 from layer 61; 137 and 139 from layer 32.

Not illustrated: 25 body sherds in oxidized sandy fabrics, some with dark green external glazes and one small body sherd in fine white fabric with a bright yellow-green speckled glaze. ? French import.

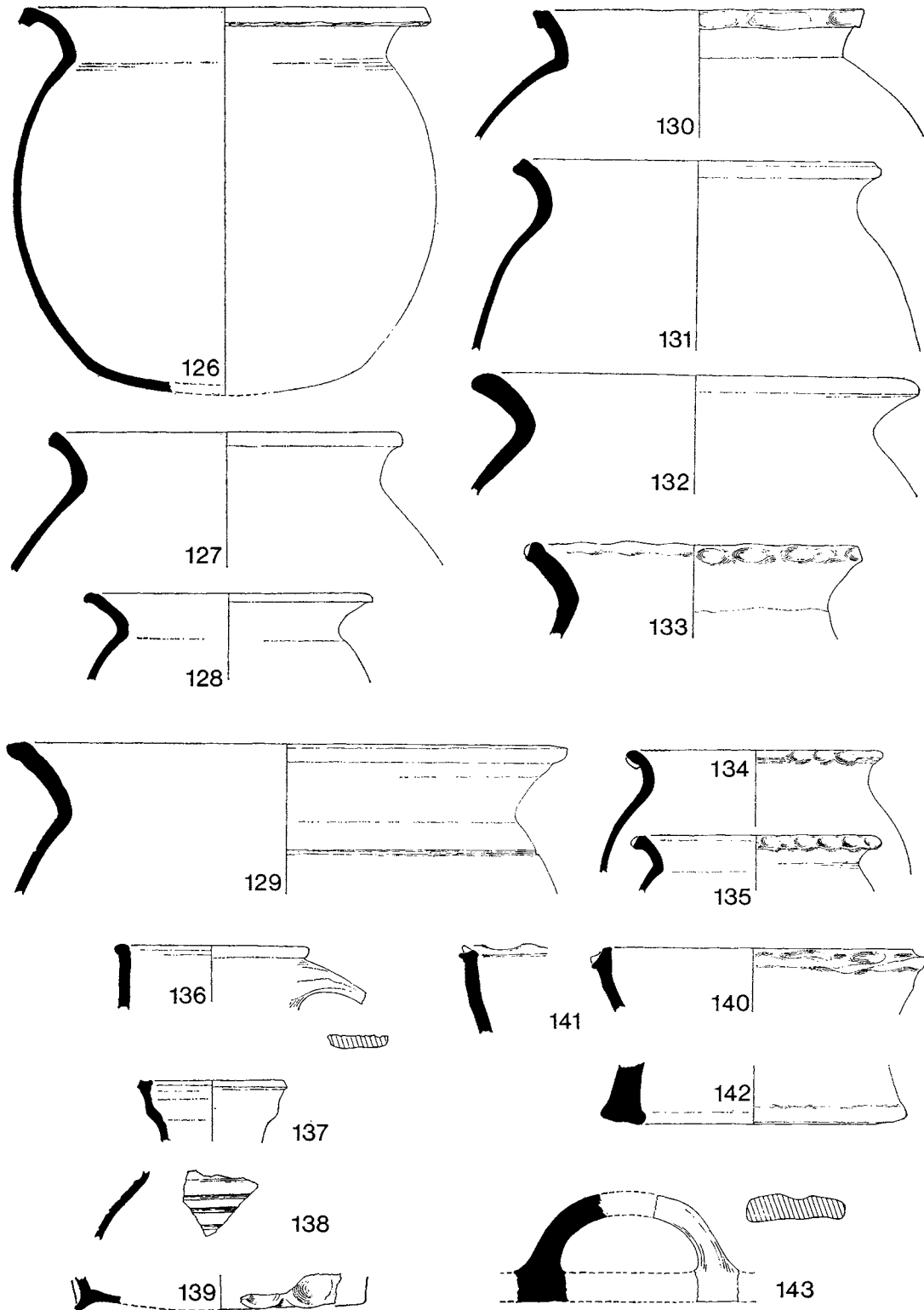

FIG. 85. Pottery from pit 132 (pp. 153, 155). Scale $\frac{1}{4}$

- 140-1. Dishes. Grey sandy ware with some flint grits, fired red on the surfaces. Finger-impressed rims. Both from layer 32.

Not illustrated: two similar vessels.

142. Chimney in coarse reddish brown flint-gritted ware.
From layer 32.
143. Handle of curfew. Coarse grey flint-gritted ware, fired red-black. Rough stab marks from upper surface of handle.
From layer 32.

Developed medieval tradition: thirteenth-century.

Pit 146 (95, layers 103, 112, 114, 115, 116, 118, 119)

Not illustrated: two simple rims of early medieval cooking pots.
Date uncertain.

Pit 152 (97, layers 14, 39, 53)

Not illustrated: 11 body sherds of glazed pitchers, including one fragment of a strap handle; also body sherds of cooking pots in sandy gritted fabrics.

Date uncertain: *early medieval* or *developed medieval tradition*.

Pit 161 (97, layers 43-47) (fig. 86)

144. Cooking pot, sharply moulded neck angle and squared rim. In grey ware tempered with flint grits. Probably a Portchester ware type. (N.B. Other Portchester ware sherds also occur in this group.)
Layer 44.
145. Cooking pot in grey sandy ware with flint grits.
Layer 46.

Not illustrated: body sherd of green-glazed pitcher, also three body sherds and one rim fragment from a cooking pot in fine pink-buff sandy ware: wheel-turned.

Date uncertain: *?early medieval tradition*: thirteenth-century.

Pit 172 (99, layer 47) (fig. 86)

146. Cooking pot rim in grey sandy ware with some flint grits (also two body sherds).
Date uncertain.

Pit 189 (98, layer 45)

Not illustrated: two body sherds of cooking pots in grey sandy ware with flint grits.
Date uncertain.

Pit 190 (102, layers 39-41) (fig. 86)

147. Cooking pot with faceted rim. ?Wheel-turned; grey sandy ware with flint grits, fired on the surface.
Layer 40.

Not illustrated: body sherd of pitcher bearing a raised boss; in buff sandy ware with pale green glaze speckled dark green.

Developed medieval tradition: thirteenth-century.

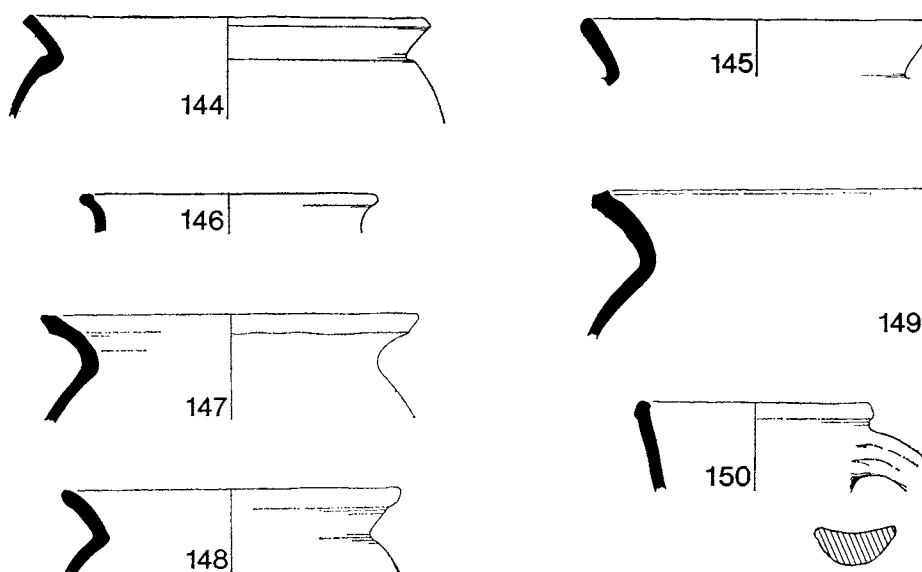

FIG. 86. Pottery from pit 161 (nos. 144-5); pit 172 (no. 146); pit 190 (no. 147); pit 199 (no. 148); pit 208 (nos. 149-50) (pp. 155-6). Scale $\frac{1}{4}$

Pit 197 (101, layers 52-5)

Not illustrated: few sherds of (?) one cooking pot with simple rim and base angle. Grey sandy ware, flint-gritted.

Date uncertain.

Pit 199 (101, layers 64, 65)

148. Cooking pot with simple rim. Dark grey ware with flint grits. Could be of the same date as late Saxon Portchester ware.

Layer 64.

Date uncertain.

Pit 208 (103, layer 37) (fig. 86)

149. Large cooking pot with squared rim. Wheel-turned. Grey sandy ware with crushed flint grit tempering. Odd spots of external green glaze.

150. Pitcher with strap handle. Fine grey sandy ware fired red on the surface: yellow-green glaze. Body sherds from same or similar vessel.

Not illustrated: sherds of thumbbed-down pitcher base.

Developed medieval tradition: thirteenth-century.

Pit 214 (108, layers 13, 23, 27-9) (fig. 87)

151. Pitcher with corrugated neck. Hard pinkish sandy ware with pale green glaze. Layer 13.

152-5. Cooking pots. Wheel-made, all in grey sandy wares with some flint grit tempering. 152 from layer 29; 153-5 from layer 13.

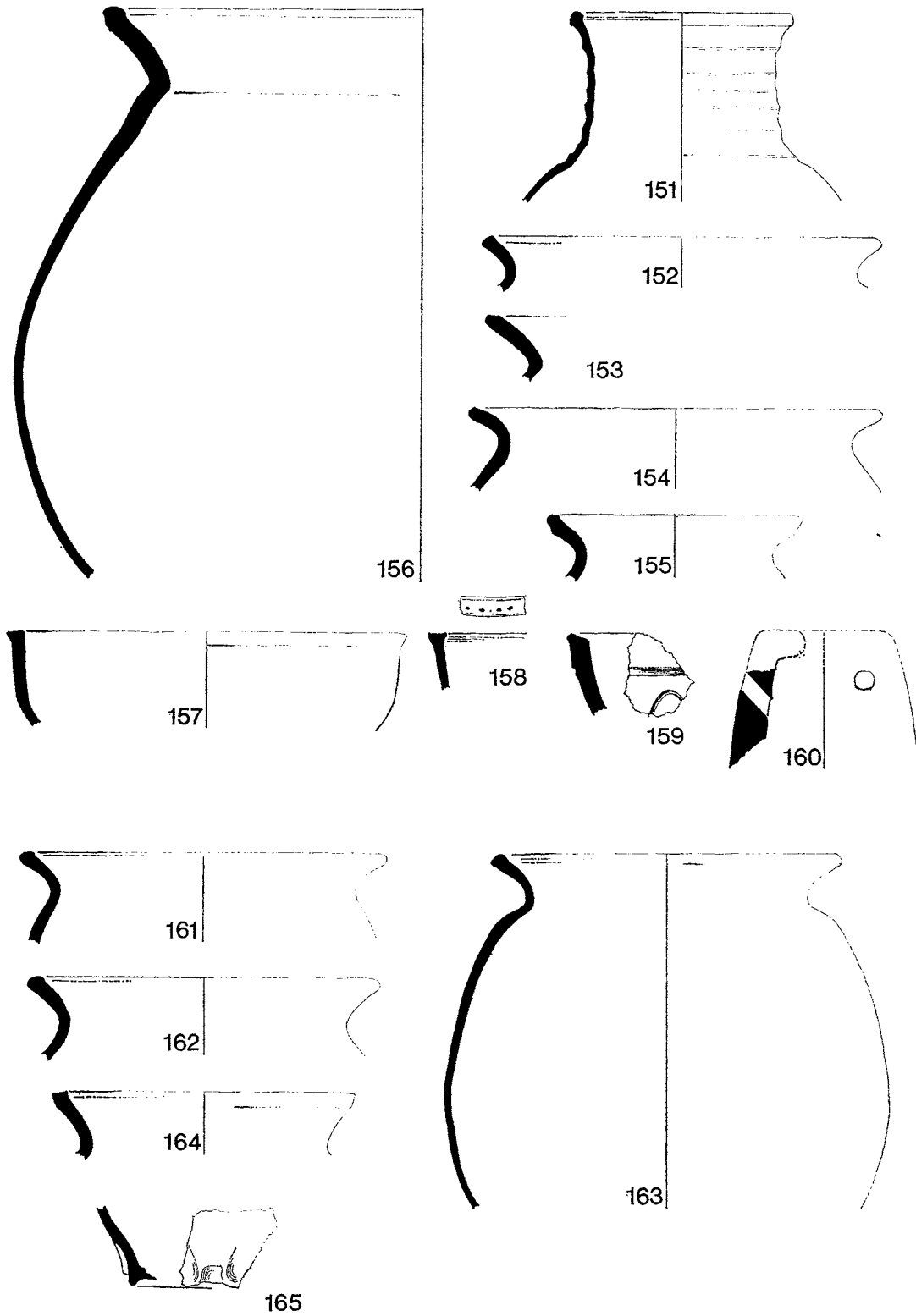

FIG. 87. Pottery from pit 214 (nos. 151-60); pit 215 (nos. 161-5) (pp. 156, 158). Scale $\frac{1}{4}$

156. Large cooking pot with simple, slightly undercut rim. Hard grey sandy ware with flint grits, fired slightly pinkish on the surface.
Layer 23.

Not illustrated: 12 other cooking pot rims, similar to nos. 132–5, of which five are simple unmoulded, six are tooled flat or square, and one is faceted. Three sherds are from the angles of sagging bases.

Not illustrated: six body sherds from at least four different glazed pitchers.

- 157–9. Dishes in brown-grey sandy ware with flint grits.
157–8 from layer 13; 159 from layer 23.
160. Chimney-pot in coarse pink ware with flint grits.
Layer 23.

Developed medieval tradition: thirteenth-century.

Pit 215 (107, layer 27) (fig. 87)

Not illustrated: two body sherds of glazed pitchers.

- 161–3. Cooking pots in grey sandy wares with flint grits.

Not illustrated: four rims of similar cooking pots.

164. Cooking pot. Wheel-turned, with sharply flattened rim in hard pink-buff sandy ware with coarse flint grits.
165. Thumbled base in grey sandy ware with flint grits.

Developed medieval tradition: thirteenth-century.

Pit 232 (109, layer 20)

Not illustrated: three body sherds of early medieval cooking pots.

Date uncertain.

Pit 233 (109, layer 54)

Not illustrated: body sherds of cooking pots, all but one in dark grey fabrics with crushed flint grits similar to Portchester ware. The isolated sherd is in a grey sandy ware fired pinkish, with crushed flint grits similar to the early medieval cooking pot fabrics.

Date uncertain: *Saxo-Norman* or *early medieval tradition*.

Gullies 1 and 2 (60, layers 7, 15; 62, layers 9, 10; 67, layer 22; 69, layers 9, 10, 27; 70, layer 28; 71, layers 10, 42, 43, 45–53) (fig. 88)

- 166–71. Cooking pots with everted rims. Wheel-made in hard grey sandy fabric with some flint grits, fired pinkish. The rims are all tightly moulded and no. 166 is ornamented with applied strips. No. 168 has splashes of green glaze on the outer surface.
166 and 168 from 71, layer 10; 167 from 71, layer 43; 169 from 60, layer 7; 170 and 171 from 60, layer 7.

Not illustrated: rims of cooking pots similar to nos. 166–71; two from 69, layer 9; one from 70, layer 28; one from 71, layer 10; three from 71, layer 43; one from 71, layer 45.

- 172–3. Skillets in red sandy ware with internal glaze, green in 172, orange in 173.
172 from 69, layer 10; 173 from 70, layer 28.

Not illustrated: handle fragment from 71, layer 43.

- 174-6. Pitchers. Grey sandy ware fired red, coated with thick green-brown glassy glaze.
174 and 175 from 69, layers 9 and 10; 176 from 60, layer 7.

Not illustrated: strap handles similar to 174 and 175 from 69, layer 10; 69, layers 9 and 10; 71, layer 10 (two examples); 71, layer 43; one thumbed-down base from 70, layer 28; two rod handles, one from 71, layer 10, and one from 71, layer 42; also body sherds, two of which are decorated with strips of brown slip under the glaze. One body sherd from 71, layer 43, has a thick dark green glaze on a buff fabric which differs from the other local types.

177. Vessel with internal ledge: hard grey sandy fabric with patchy pale green-yellow glaze outside and on the ledge.
71, layer 10.
178. Chimney in light grey sandy ware with flint grits.
71, layer 43.

Late medieval tradition: fourteenth-century.

Gully 3 (62, layer 11; 67, layer 25; 68, layer 5; 75, layer 21; 76, layer 27) (fig. 88)

- 179-80. Cooking pots. Wheel-turned in hard greyish sandy ware with flint grits.
Both from 62, layer 11.

Not illustrated: cooking pot rims in various sandy wares, one from 62, layer 11; four from 68, layer 5.

Not illustrated: pitcher sherds. Three fragments of glazed pitchers from 62, layer 11; one from 67, layer 25.

Developed or late medieval tradition: thirteenth- to fourteenth-century.

Gully 4 (60, layer 14) (fig. 88)

181. Costrel. Fragment from the lip. Hard grey sandy ware fired to light red on the surface.
182. Cooking pot. Wheel-turned. Grey sandy ware with flint grits fired light red on the surface.

Not illustrated: cooking pots, one similar rim to 182 and a body sherd with spots of green glaze.

Not illustrated: pitcher sherds, one small rim fragment, one thumbed base and two body sherds with dark green-brown glaze.

Late medieval tradition: fourteenth-century.

Gully 5 (68, layer 6)

Not illustrated: few body sherds of cooking pots in grey sandy wares tempered with flint grits.

Date uncertain.

Gully 6 (57, layers 4, 8; 85, layers 3 and 6) (fig. 88)

- 183-4. Cooking pots. Wheel-made in hard grey sandy ware, fired reddish on the surface.
Both from 57, layer 4.
185. Pitcher with strap handle. Hard grey sandy ware fired pale red. Mottled pale green glaze with dark green spots.
From 85, layer 6.

Not illustrated: body sherds of pitchers with dark green glaze.

Late medieval tradition: fourteenth-century.

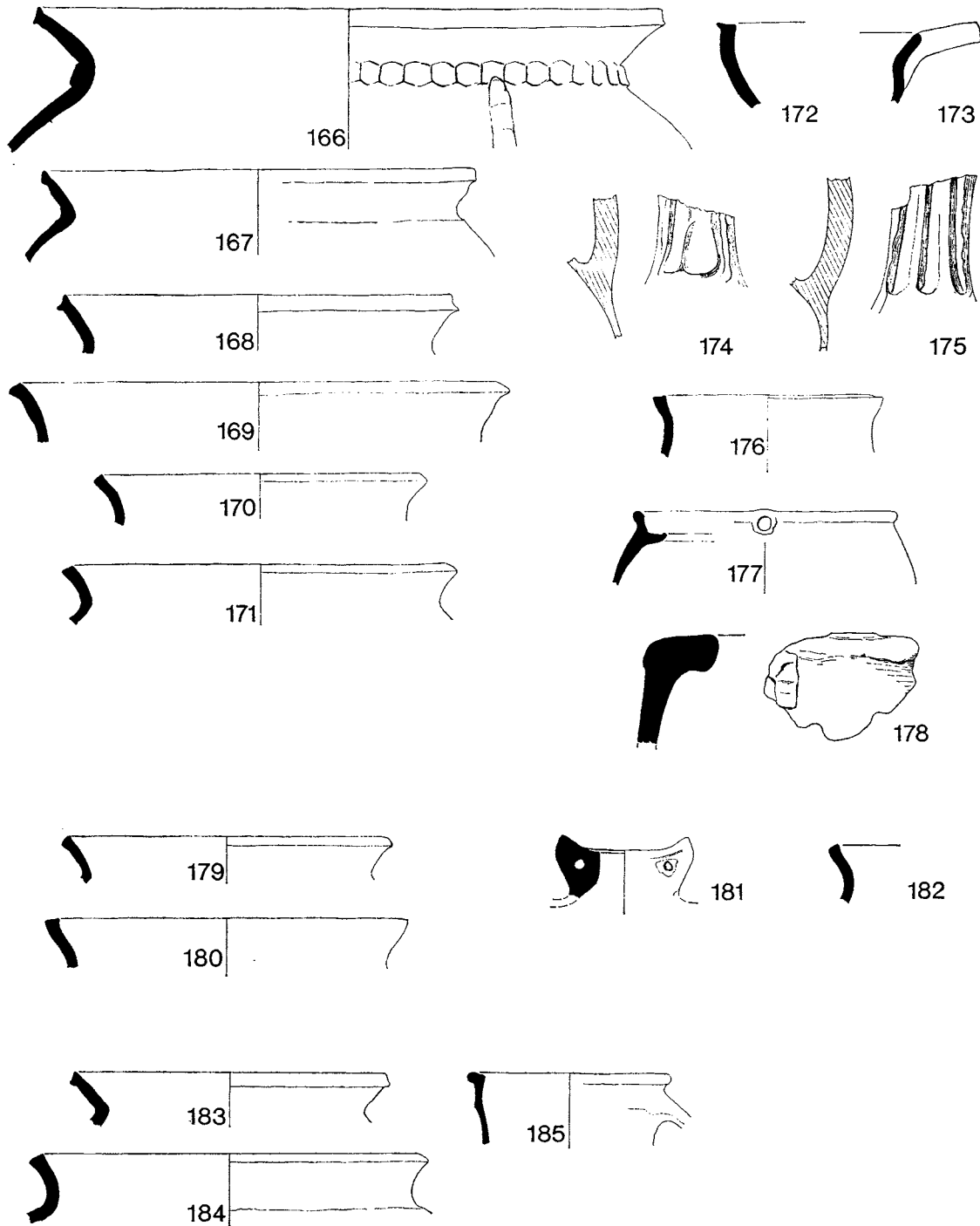

FIG. 88. Pottery from gullies 1 and 2 (nos. 166-78); gully 3 (nos. 179-80); gully 4 (nos. 181-2); gully 6 (nos. 183-5) (pp. 158-9). Scale $\frac{1}{4}$

Gully 7 (57, layer 9)

Not illustrated: cooking pot rim, similar to no. 184, and two green-glazed body sherds.
 ? *Late medieval tradition*: fourteenth-century.

Gully 8 (57, layer 10; 85, layer 7) (fig. 89)

- 186-8. Cooking pots. Wheel-turned in hard grey sandy ware, fired red.
 186 and 187 from 85, layer 7; 188 from 57, layer 10.
- 189-90. Skillets in hard grey sandy ware. Sherd 190 is covered with a light green glaze speckled dark green.
 189 from 57, layer 10; 190 from 85, layer 7.
191. Pitcher sherds with (?) face decoration. Hard grey sandy ware with speckled green-brown glaze. The 'eye' is composed of a thick brown slip.
 From 57, layer 10.

Not illustrated: pitcher fragments including two sherds with thumbled bases from 85, layer 7.

192. Curfew in wheel-turned grey sandy ware with flint grits, fired pinkish externally.
 From 85, layer 7.

Late medieval tradition: fourteenth-century.

Gully 9

Apart from a few residual sherds, the pottery from the western re-cut of gully 9 belongs to the first decades of the sixteenth century. It is illustrated and described in detail below, pp. 180-3.

From the original (eastern) fill of the gully:

Not illustrated: cooking pot, wheel-turned in sandy ware. From 75, layer 42. Pitchers: two glazed pitcher body sherds, one decorated with applied ribs, one with pellets of brown clay. From 75, layer 42.

Gully 11 (85, layer 25)

Not illustrated: a few cooking pot body sherds of early medieval fabric.
 Date uncertain: ? *early medieval tradition*.

Gully 16 (94, layers 49, 53; 95, layers 32, 41; 96, layer 44; 97, layers 52, 54; 98, layer 44; 100, layers 61, 62; 101, layers 19, 32, 33, 116) (fig. 89)

- 193-6. Cooking pots. Wheel-made in grey sandy wares with flint grits, some fired to pinkish surface.
 All from 100, layer 61. No. 193 has neck handle with much hand finishing around.

Not illustrated: similar rim sherds from 100, layer 62 (two examples); 101, layer 116; 97, layer 54.

197. Pitcher. Wheel-made in grey sandy ware with flint grits; fired pinkish. No glaze.
 From 100, layer 61.
198. Dish with pie-crust lip. Dark grey ware with copious flint grits: (?) hand-made.
 From 101, layer 33.
199. Pitcher with strip handle. Pinkish grey sandy ware with thick dark green glaze.
 From 96, layer 44.

Not illustrated: pitcher body sherd from 97, layer 54.

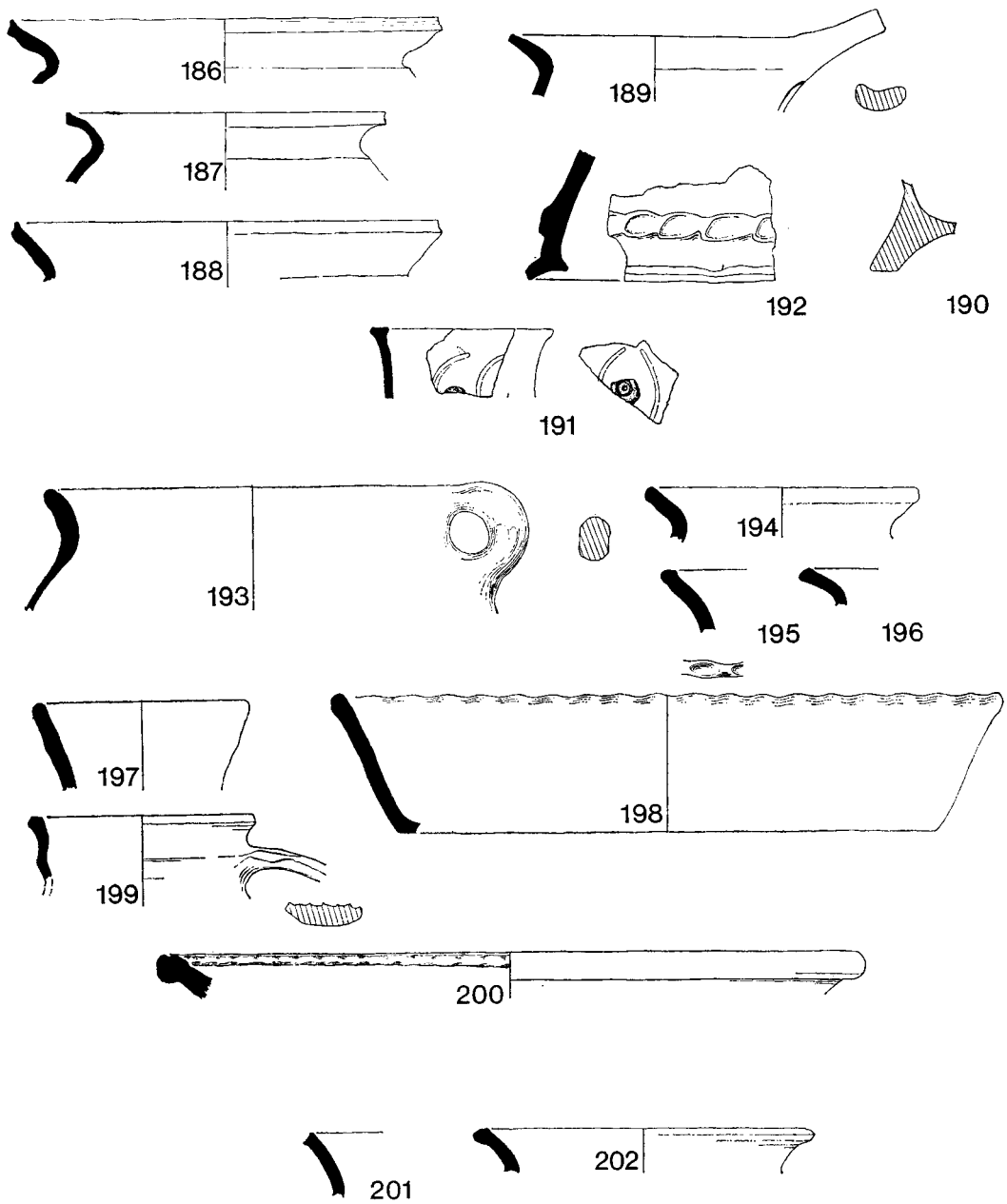

FIG. 89. Pottery from gully 8 (nos. 186-92); gully 16 (nos. 193-200); gully 17 (nos. 201-2) (pp. 161, 163). Scale $\frac{1}{4}$

200. Large vessel with everted rim decorated with an applied strip internally. Wheel-made grey sandy ware with some flint grits.
From 95, layer 32.

Developed medieval tradition: thirteenth-century.

Gully 17 (95, layer 93) (fig. 89)

- 201-2. Cooking pots. Wheel-turned in hard grey sandy ware with flint grit tempering.

Not illustrated: pitcher. Body sherd in pink sandy ware with thick green glaze.

(?) *Late medieval tradition*: fourteenth-century.

Gully 18 (95, layers 102, 117) (fig. 90)

- 203-6. Cooking pots. Wheel-made in hard sandy wares with sparse flint grits. Various moulded rims: no. 203 with external pie-crusting.
All from 95, layer 102.

Not illustrated: similar rim from 95, layer 102; two body sherds of a large cooking pot with finger-impressed applied strip decoration from 95, layer 102; body sherds of green-glazed pitchers and the foot of a skillet from 95, layer 102.

Late medieval tradition: fourteenth-century.

Gully 19 (97, layers 26, 34, 50) (fig. 90)

207. Cooking pot in hard red sandy ware.
From 97, layer 50.

Not illustrated: two cooking pot rims. Wheel-turned in grey sandy wares from 97, layer 34.

208. Pitcher with rod handle in hard grey sandy ware, fired pinkish. Brownish green glaze.
From 97, layer 50.
209. Pitcher in hard buff sandy ware with splashes of dark green and yellow glaze.
From 97, layer 50.
- 210-11. Pitcher (both sherds probably from the same vessel) ornamented with a face. Hard grey sandy ware with glossy green-brown glaze. The eye is constructed from an applied pellet of brownish clay; the moustache is a finger-nail-impressed applied strip.
From 97, layer 26.
212. Strap handle of a pitcher. Sandy ware fired red throughout.
From 97, layer 34.
213. Base of pitcher with thumbbed-down ledge feet. Hard grey sandy ware fired pinkish on the surface. Thick green-brown mottled glaze on the underside of the base.
From 97, layer 26.

Late medieval tradition: fourteenth-century.

Gully 20 (97, layer 36)

Not illustrated: a few body sherds including one from a green-glazed pitcher.

Date uncertain: *developed* or *late medieval tradition* (?): thirteenth- to fourteenth-century.

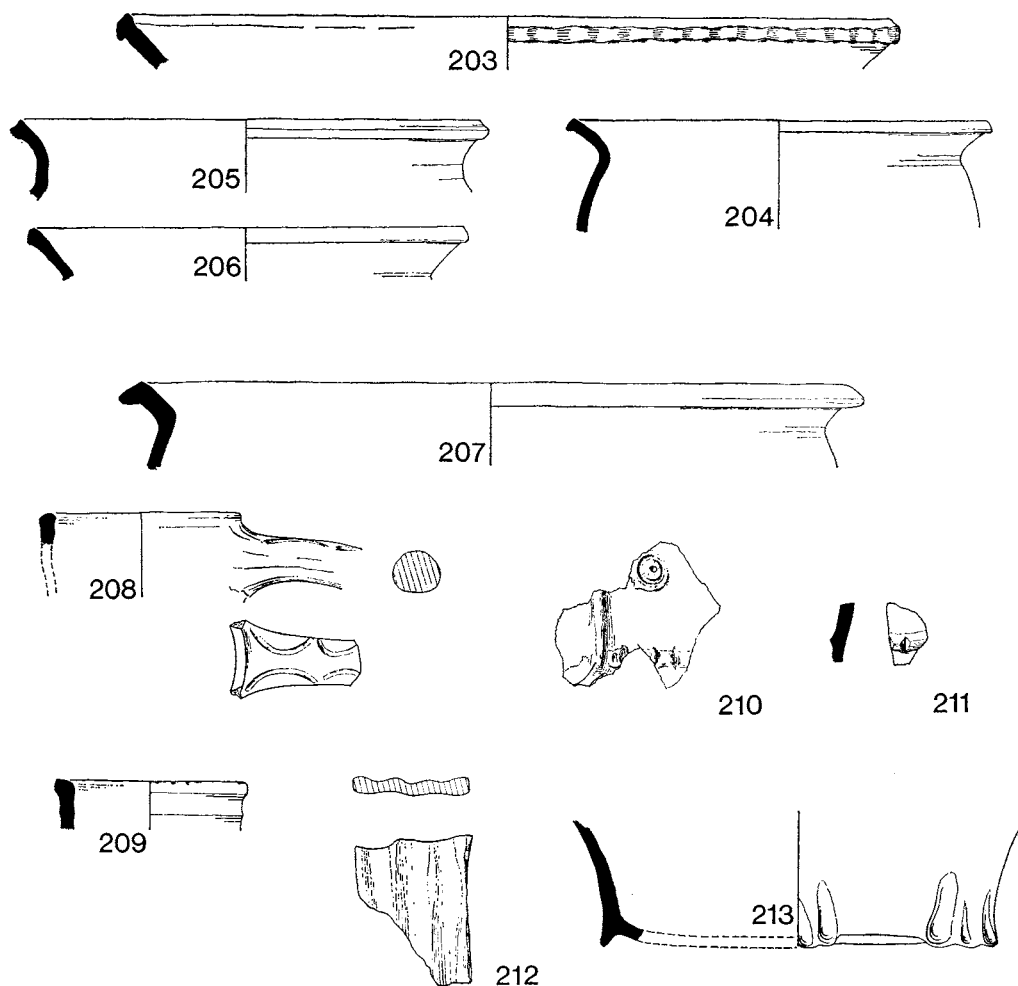

FIG. 90. Pottery from gully 18 (nos. 203-6); gully 19 (nos. 207-13) (p. 163). Scale $\frac{1}{4}$

Gully 21 (97, layer 41)

Not illustrated: few body sherds including four from green-glazed pitcher.

Date uncertain: *developed* or *late medieval tradition* (?): thirteenth- to fourteenth-century.

Gully 28 (96, layers 30, 45)

Not illustrated: body sherds of early medieval cooking pots.

Date uncertain.

Gully 29 (97, layer 57; 98, layers 48, 61)

Not illustrated: pitcher with strap handle in hard grey sandy ware fired pinkish: with spots of green glaze (from 97, layer 57), also body sherds of cooking pots in hard sandy fabrics.

Date uncertain.

Gully 30 (98, layer 35)

The few body sherds from this gully are consistent with the early sixteenth-century date of gully 9, of which system it forms a part.

Gullies 31 and 32 (31 in 98, layer 24; 32 in 98, layers 26, 27, 33, 56, 57, 58)

Not illustrated: a few eroded body sherds from 98, layer 33, include a glazed pitcher and several sherds from sandy fabric cooking pots.

Date uncertain.

Gullies 33, 34, 35, 37

The finds from these gullies are all residual Roman material, with the exception of a medieval cooking pot sherd from gully 37.

Dates uncertain.

Gully 38 (72, layer 40)

A few sherds of gritty cooking pots.

Twelfth- or thirteenth-century.

*Pottery from layers relating to Building M1**Occupation: phase I* (33, layer 5)

Not illustrated: sherds of a cooking pot with sagging base in hard pinkish-grey ware with flint grits.

Destruction: phase I (33, layer 4; 34, layer 4; 37, layer 4) (fig. 91)

214-19. Cooking pots. Wheel-turned in hard grey sandy ware with flint grits. Fired reddish on the surface. One from 34, layer 4, the rest from 37, layer 4. Nos. 215 and 219 both have specks of green glaze on their surfaces.

Not illustrated: five cooking pot rims similar to nos. 214-18. Among the body sherds is one sagging base (two from 37, layer 4; three from 34, layer 4). Two cooking pot rims similar to nos. 214-18 from 33, layer 4.

220-1. Pitchers with strap handles in hard grey sandy wares; no. 220 was fired to red on the surface. Both have external green glazes.
From 37, layer 4.

Not illustrated: three strap handles; two from 33, layer 4, and one from 37, layer 4. Also from 37, layer 4. Also from 37, layer 4, a rod handle and a fragment of the lip of a pitcher similar to nos. 220 and 221.

222. Pitcher shoulder in hard grey sandy ware with splashes of green glaze.

From 37, layer 4.

223. Dish with pie-crust rim in grey-brown sandy ware fired black on the outer surface.

From 37, layer 4.

Not illustrated: dish similar to no. 223 from 33, layer 4.

224. Base of a dish (?) in hard grey sandy ware with some flint grits coated internally with a thick green-brown glaze. Applied diagonal strip externally.

From 37, layer 4.

EXCAVATIONS AT PORTCHESTER CASTLE

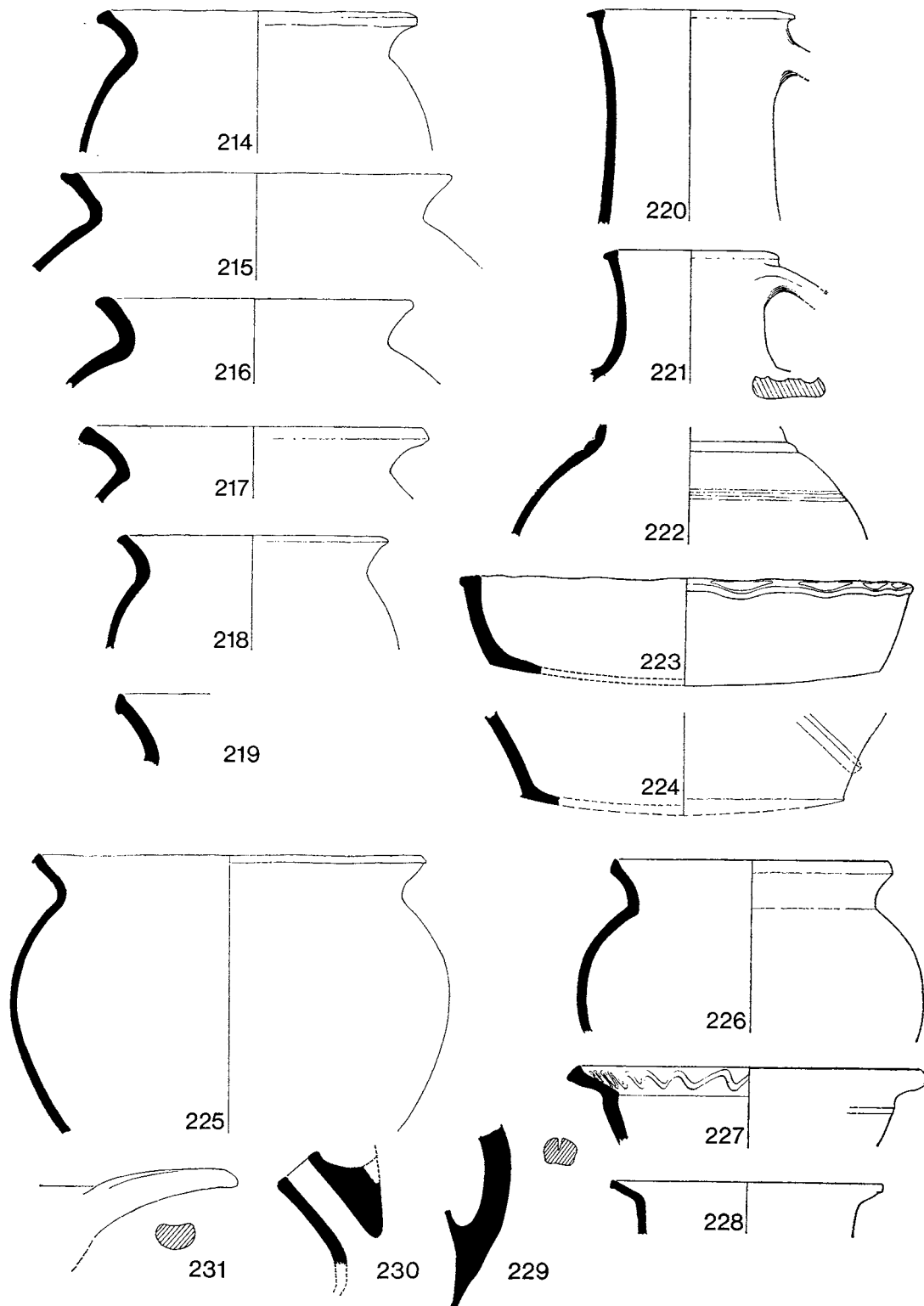

FIG. 91. Pottery from building M1 (pp. 165, 167). Scale $\frac{1}{4}$

Not illustrated: base similar to no. 224 but in a finer fabric. Also the foot from a tripod pitcher. Both from 37, layer 4.

Developed or late medieval tradition: thirteenth- to fourteenth-century.

Occupation: phase 2 (33, layers 2, 3; 37, layer 3) (fig. 91)

- 225-6. Cooking pots. Wheel-made in hard grey sandy ware. No. 226 has external spots of green glaze.
From 37, layer 3.
- 227-8. Dishes in fine hard grey sandy ware fired red-brown. The rim of no. 227 is decorated with an incised wavy line.
From 37, layer 3.
229. Pitcher with rod handle in hard grey sandy ware fired red-brown. Patchy green-brown glaze.
From 37, layer 3.
230. Spout of pitcher in hard grey-buff ware with a deep green glaze.
From 37, layer 3.
231. Skillet handle in hard grey sandy ware fired red. Patchy green glaze over the handle.
From 37, layer 3.

Ultimate medieval tradition: fifteenth-century.

Pottery from the occupation levels associated with Building M2 (45, layer 2, 87, layers 2, 3; 88, layers 3, 7) (figs 92, 93)

Since the division into trenches and layers was arbitrary all layers can be regarded as part of the same chronological horizon.

- 232-42. Cooking pots. Wheel-made with tightly moulded lips of varying profiles. Generally there is oblique or vertical flattening of the rim top and grooving inside the lip. No. 241 has a finger-marked applied strip in the neck angle. The fabrics vary slightly, but all are hard and sandy, and some have sparse flint grits. The vessels are fired to a pink or pinkish buff. Spots of glaze occur.

Not illustrated: a further 46 rim sherds of similar type.

- 243-7. Cooking pots. Wheel-made without tightly moulded rims: sometimes the rims have been flattened. The fabric is generally coarser than that of nos. 232-241, with more flint grit. Firing is less even and is usually grey or dark brown.

Not illustrated: a further 55 rim sherds of similar type.

248. Skillet in hard grey sandy ware fired red on the surfaces. The inside of the lip is coated with a thin light green glaze with darker green spots.

Not illustrated: a skillet handle and a foot.

- 249-50. Dishes in hard grey sandy ware with flint grits, fired reddish on the surfaces.

Not illustrated: a further 13 rim sherds of similar types.

251. Dish (?) in hard grey sandy ware. Coated internally with an even mid-green glaze.

Not illustrated: one further example.

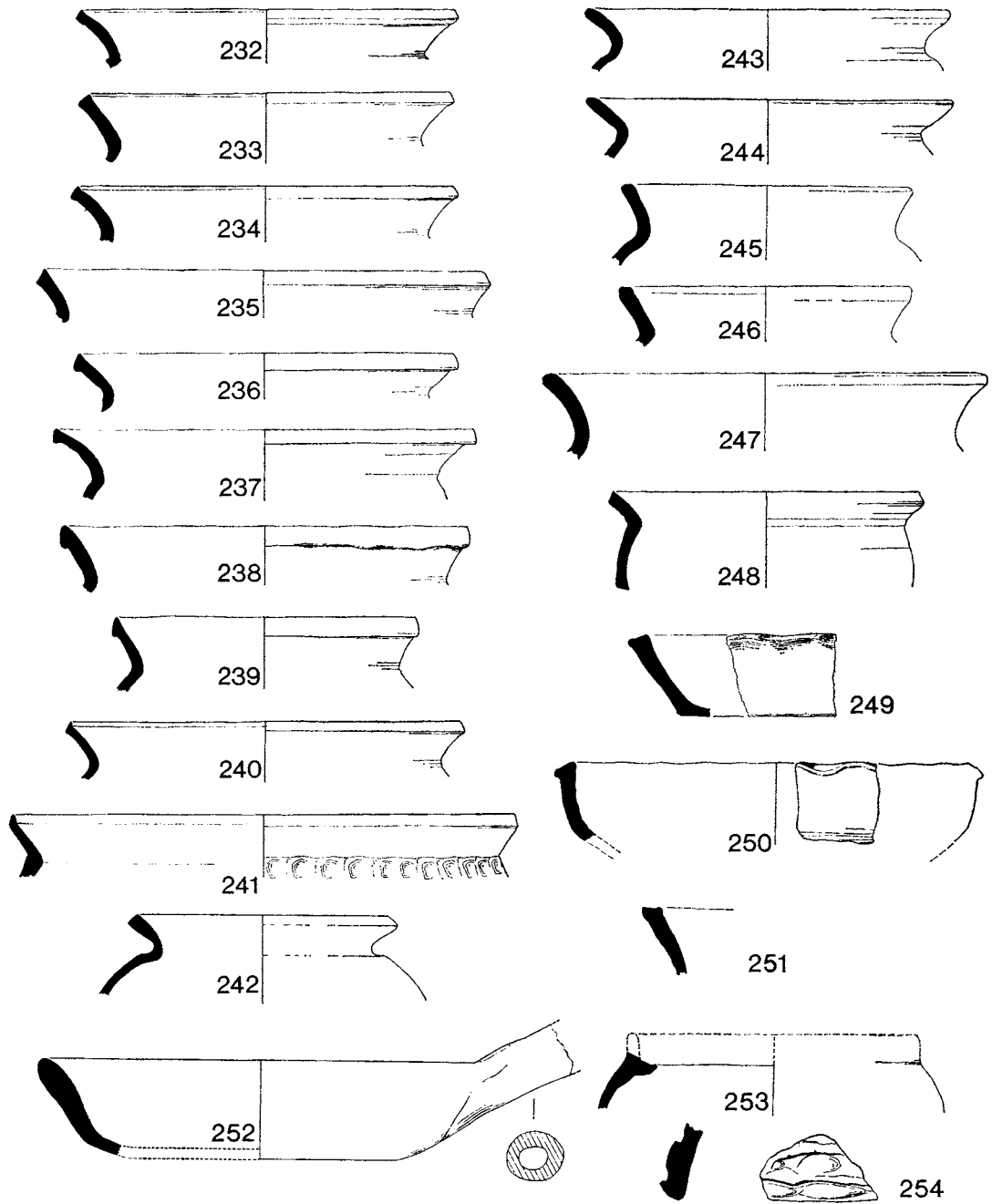

FIG. 92. Pottery from building M2 (pp. 167, 170). Scale $\frac{1}{4}$

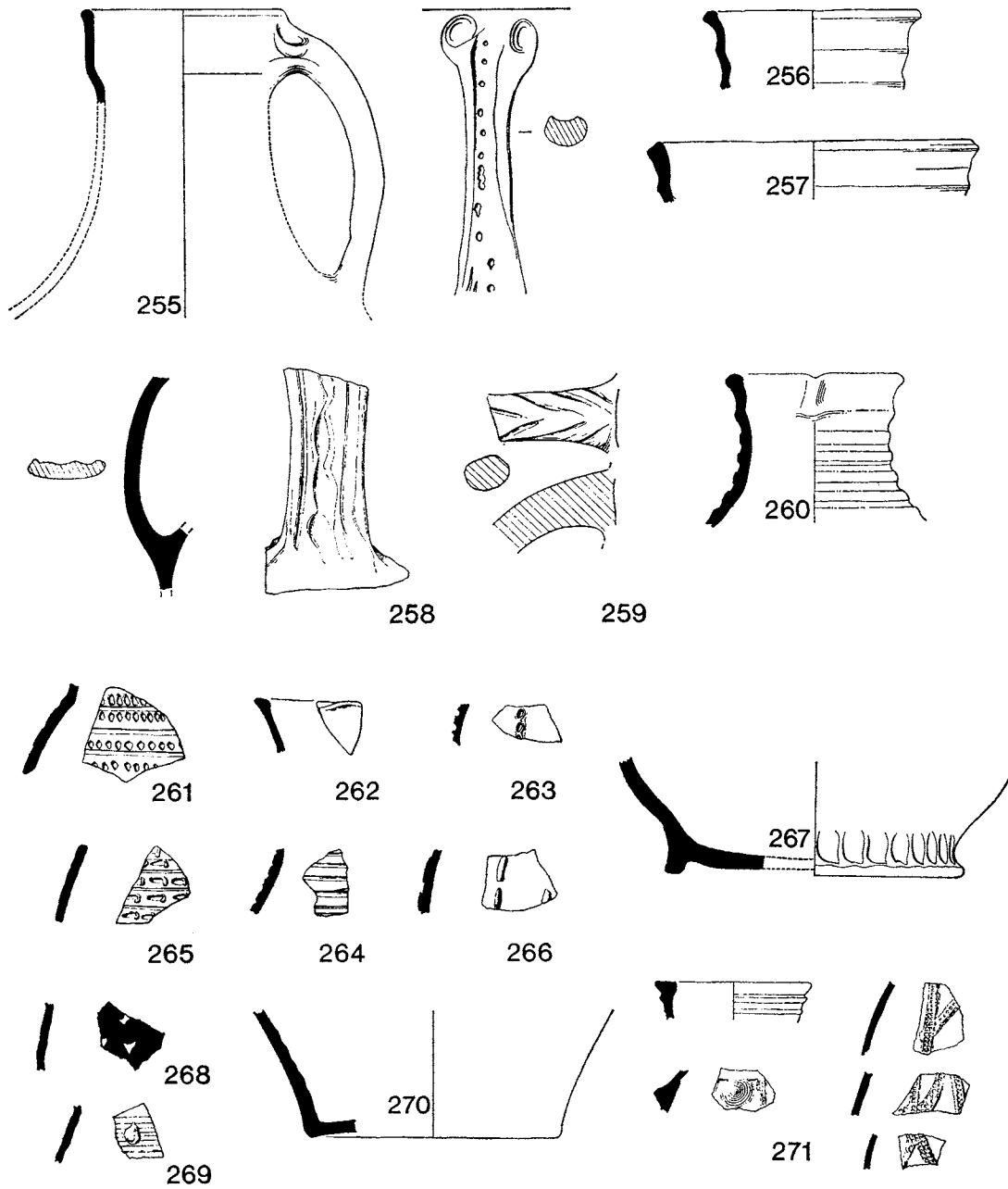

FIG. 93. Pottery from building M2 (p. 170). Scale $\frac{1}{4}$

252. Dish with socketed handle in hardened red sandy ware coated internally with dark green glaze.
253. Vessel with internal flange. Hard grey sandy ware with a thin green glaze externally and on upper surface of the flange.
254. Curfew in hard grey sandy ware with some flint grits, fired red on the surfaces.
255. Pitcher with grooved rod handle. Hard red ware with dark orange glaze.
256. Pitcher with corrugated neck. Hard grey sandy ware fired red on the surfaces: patchy mottled green glaze.
257. Pitcher with wide mouth. Hard grey sandy ware fired red on the surface: thick green-brown streaky glaze.
258. Strap handle from pitcher. Hard grey sandy ware fired red on the surface. Thick green-brown streaky glaze.
259. Rod handle from pitcher. Grey sandy ware with some flint grits, fired red on the surfaces. Mottled green glaze over upper surface of handle.
260. Pitcher with corrugated neck. Hard grey sandy ware fired red on the surfaces: no glaze.
- 261-2. Sherds of (?) the same pitcher. Hard red sandy ware with thick dark green-brown glaze. Decorated with stabs and grooves in horizontal arrangement.
- 263-6. Body sherds of pitchers to illustrate range of decoration. All in hard sandy wares fired red. Nos. 263 and 264 have orange glaze; 265 mottled dark green; 266 thick brown.
267. Thumbed pitcher base. Hard grey sandy ware fired buff.

Not illustrated: pitchers, five rims, seven strap handles, one rod handle, six thumbed bases, and a range of body sherds.

In addition to the decorative techniques illustrated, one sherd has sgraffito ornament, five have pellets or strips of brown slip beneath the glaze, and three are combed.

268. Body sherd of a vessel in hard pinkish buff sandy ware. The surface is thinly painted in brick red. ?French.
269. Fragment of a vessel in fine hard white ware. The surface is ridged, the grooves concentrating the thin brown paint that had been applied. The pellet was added later before the application of a thin yellow glaze. French.
270. Base of a pitcher in hard off-white ware with some sand particles. The outer surface is coated with a thin apple-green glaze. French.
271. Rim and seven body sherds of a pitcher in fine hard white fabric coated with a thick apple-green glaze. The decoration consists of grooves below the rim, pointed bosses and applied strips with rouletted surfaces. French.

These distinctive fragments were widely scattered in 88, layers 2, 3 and 5; 89, layer 8; and 90, layer 6. *Developed to late medieval tradition*: thirteenth- to fourteenth-century.

From the postholes of Medieval Building 2 (not illustrated)

- Ph 641 Pitcher sherd.
- Ph 642 Cooking pot sherds.
- Ph 643a Cooking pot sherds.
- Ph 649 Dish with thumbed-rim top, pitcher sherd and cooking pot rim.
- Ph 650 Dish with thumbed-rim top.

The distinctive forms are all represented among the pottery from the contemporary occupation layers.

*Pottery associated with Medieval Building 3**From rubble layers above* (107, layer 4; 108, layer 20)

(This includes much material derived from the occupation layers beneath.)

Not illustrated: the pottery is fragmentary but is entirely within the range represented by the levels contemporary with building 2 (nos. 232-71). Seven cooking pots as nos. 232-42; 12 cooking pots as nos. 243-7; one fragment of skillet, two dishes, one with a handle socket, one with an external applied strip, finger-impressed; two pitcher rims; four pitcher strap handles.

From occupation layers (107, layers 21, 22, 23, 29; 108, layers 24, 31, 33, 75)

Not illustrated: the pottery is fragmentary, but is entirely within the range represented by the levels contemporary with building 2. Two cooking pots as nos. 232-42; four cooking pots as nos. 243-7; one skillet rim; one dish; one pitcher rim; two strap handles.

From postholes and hollows (not illustrated)

Feature M7 Body sherds of cooking pots.

Ph 1204 Two cooking pots as nos. 243-7 and pitcher sherds.

Developed to late medieval tradition: thirteenth- to fourteenth-century.*Pottery associated with Limekiln 2**From the rubble layers filling the kiln and raking pits* (90, layers 8, 13, 14, 15, 17; 89, layers 8a, 24) (fig. 94)

272-4. Cooking pots. Wheel-turned in hard sandy ware, fired pinkish. No. 272 has been cooled in a reducing atmosphere.

272 from 89, layer 24; 273 from 90, layer 15; 274 from 90, layer 14.

Not illustrated: eight cooking pot rims similar to nos. 243-7.

275-7. Dishes with flattened or pie-crust rims in hard grey sandy ware fired to red-brown.

275-6 from 90, layer 14; 277 from 89, layer 8a.

Not illustrated: two similar types.

Not illustrated: pitchers, numerous small body sherds, one rod handle, one rim and one thumbled base.

Late medieval tradition: fourteenth-century.*Pottery from tip of occupation rubbish* (54, layer 3a) (fig. 94)

278-9. Cooking pots. Wheel-turned in grey sandy wares with some flint grits.

Not illustrated: four similar rim fragments.

280. Pitcher with swelling for spout. Hard grey sandy ware fired red on the surface with external mottled green glaze.

Not illustrated: pitcher strap handle and other pitcher sherds.

281. Dish with socketed handle. Grey sandy ware fired reddish on the external surface. Coated internally with thin light green glaze (possibly same vessel as no. 251).

Developed or late medieval tradition: thirteenth- to fourteenth-century.

EXCAVATIONS AT PORTCHESTER CASTLE

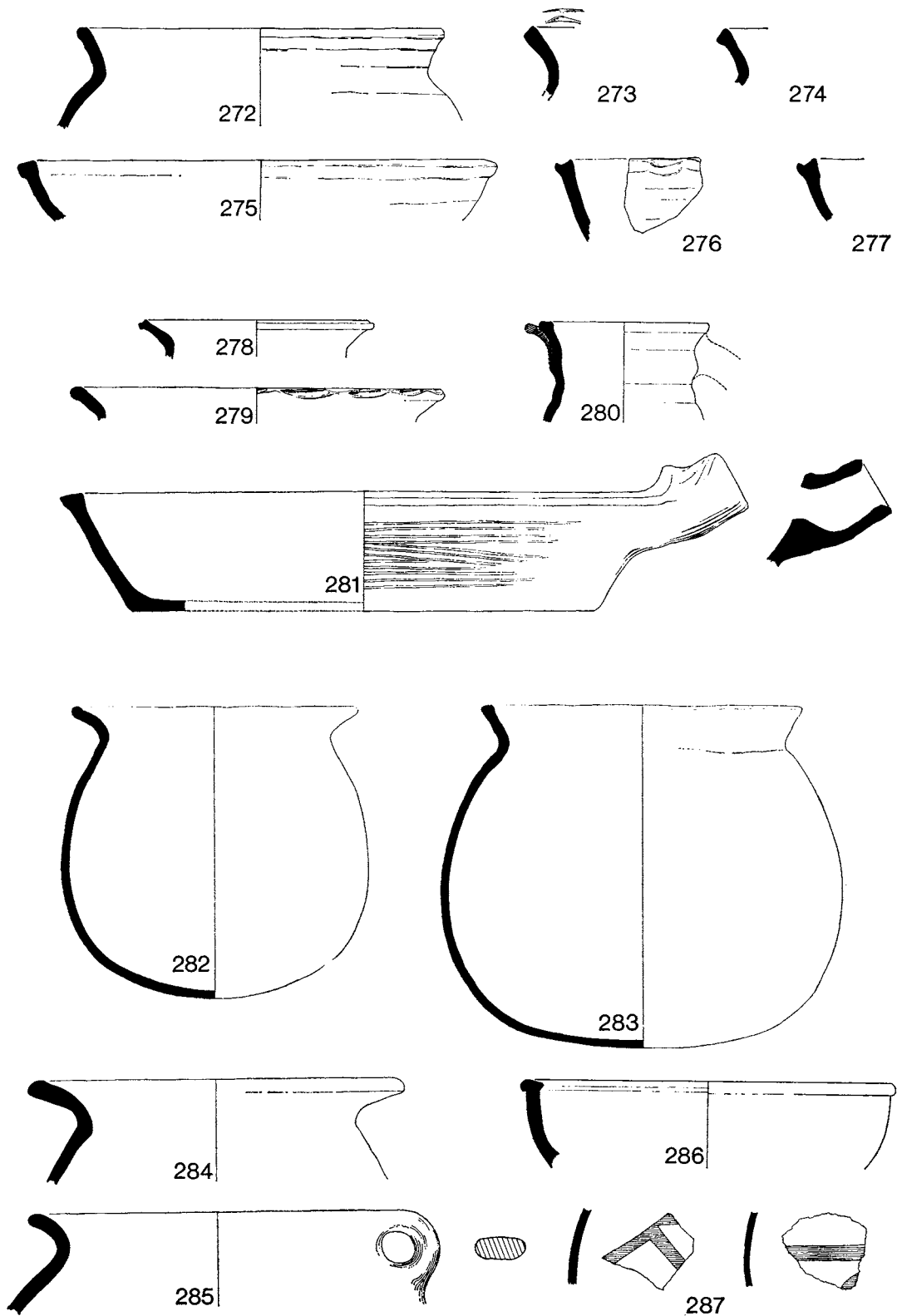

FIG. 94. Pottery from Limekiln 2 (nos. 272-7); from trench 54, layer 3a (nos. 278-81); from foundation trench at south postern (nos. 282-7) (pp. 171, 173). Scale $\frac{1}{4}$

Pottery in foundation trench against blocking wall at the south postern gate (28a, layers 2, 3) (fig. 94)

282-5. Cooking pots in grey sandy wares with flint grits. Several are wheel-finished.

Not illustrated: a further 12 rims of similar types.

286. Dish in dark grey ware with flint grits, fired reddish on the surfaces.

Not illustrated: another dish with pie-crust rim top.

287. Pitcher with sgraffito decoration in hard grey ware fired red on the surfaces. The outer surface was coated with a thin white slip which has been scraped off in strips before the application of a thin green glaze.

Not illustrated: rod handle from pitcher.

Early medieval tradition: twelfth-century.

Pottery relating to landgate from occupation layer (10, layer 4) (fig. 95)

288. Cooking pot. Hand-made in grey sandy ware with flint grits, fired red-brown on the surfaces; scratched decoration.

Early medieval tradition: twelfth-century.

Single pot set in a small pit (71, layer 9) (fig. 95)

289. Cooking pot in hard red sandy ware with sparse flint grits decorated with applied finger-impressed strips.

Late medieval tradition: fourteenth-century.

Miscellaneous pottery from general medieval layers within the 1964-72 area excavation (figs. 96, 97)

The following selection has been made from the sherds recovered from the soil levels which accumulated in the medieval period, unassociated with features or structures. Types already well represented in the closed groups illustrated above have been omitted.

290-8. Cooking pots. Wheel-turned in hard sandy fabrics with sparse flint grits. Usually fired to a light brown or red. Spots of glaze occur on 292, 294 and 298, while 296 is glazed inside the rim and may be part of a skillet.

290 from 89, layer 4; 291 from 95, layer 61; 292 from 97, layer 23; 293-5 from 89, layer 8; 296 from 90, layer 6; 297 from 97, layer 11; 298 from 89, layer 8.

299-302. Dishes in sandy fabrics with flint grits, fired to a reddish brown externally. Two have handle sockets. No. 299 is wheel-turned, the others ?hand-made.

299 from 91, layer 4; 300 from 94, layer 92; 301 from 65, layer 4; 302 from 67, layer 7.

303-5. Dishes, wheel-turned, in fine red sandy fabrics. No. 303 has glaze spots on the rim; 304 has a green glaze internally covering the base; 305 has a thick dark green glaze internally and discontinuous glaze externally.

303 from 71, layer 4; 304 from 97, layer 23; 305 from 71, layer 6.

306. Spouted pitcher in grey sandy ware with flint grits. No glaze.

From 91, layer 21.

307-26. Glazed pitchers in grey sandy ware fired red on the surfaces or throughout.

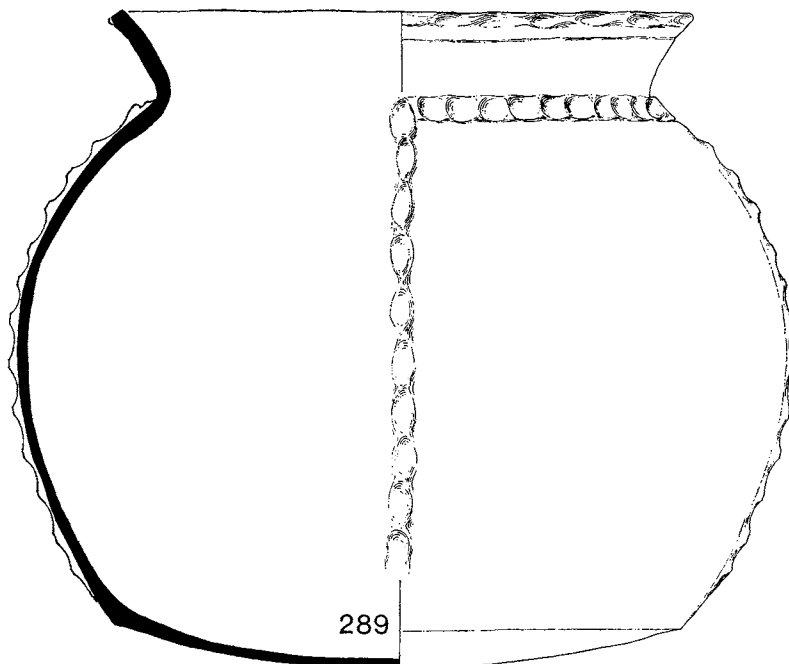
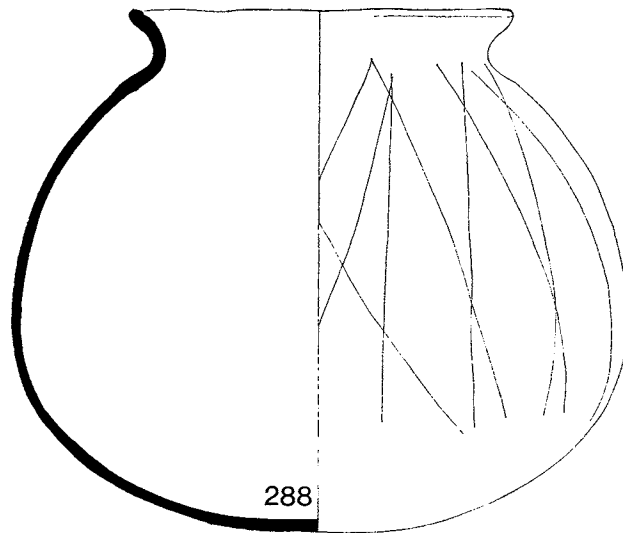

FIG. 95. Pottery from landgate (no. 288); from trench 71, layer 9 (no. 289) (p. 173). Scale $\frac{1}{4}$

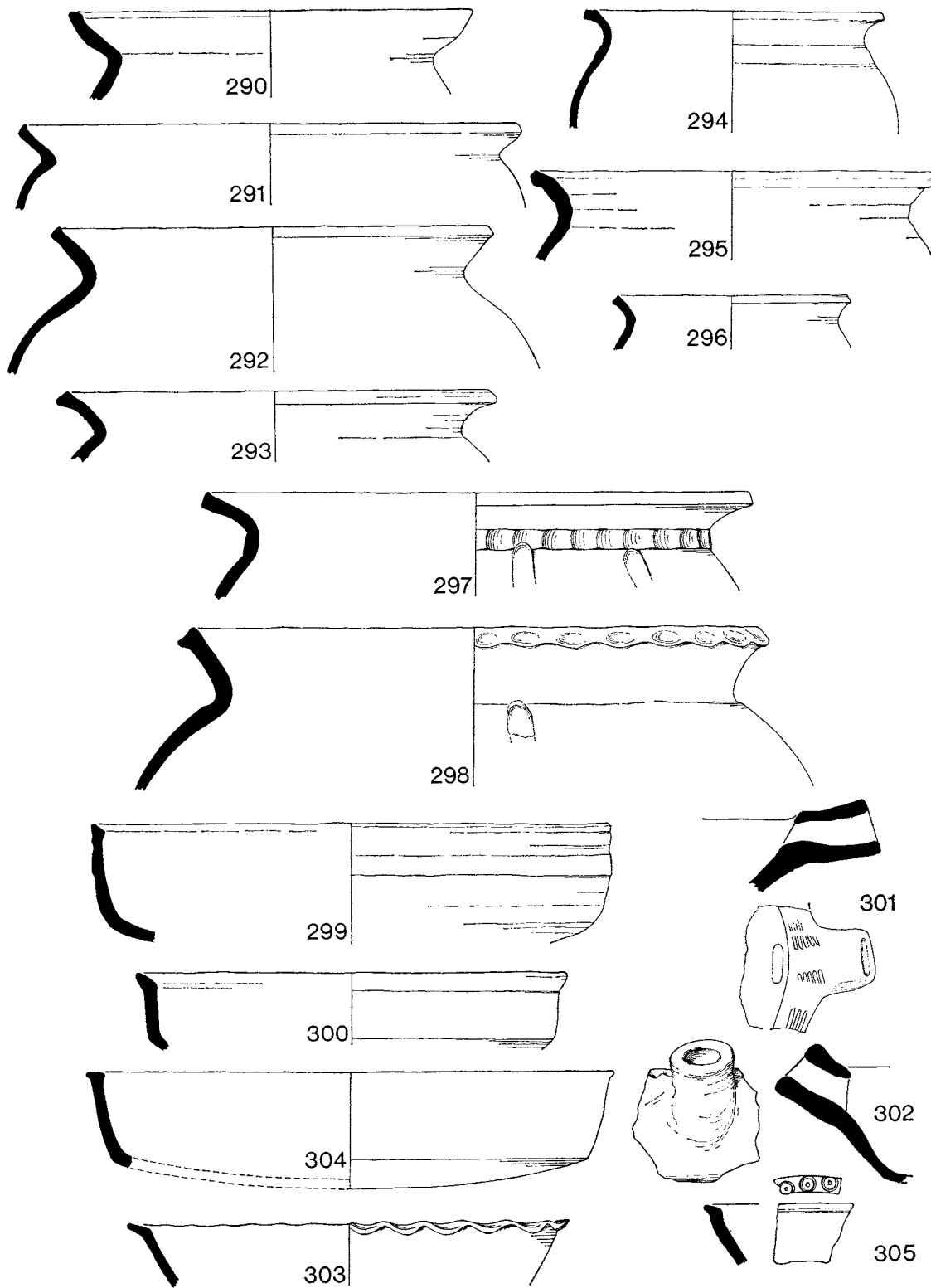

FIG. 96. Pottery from general layers (p. 173). Scale $\frac{1}{4}$

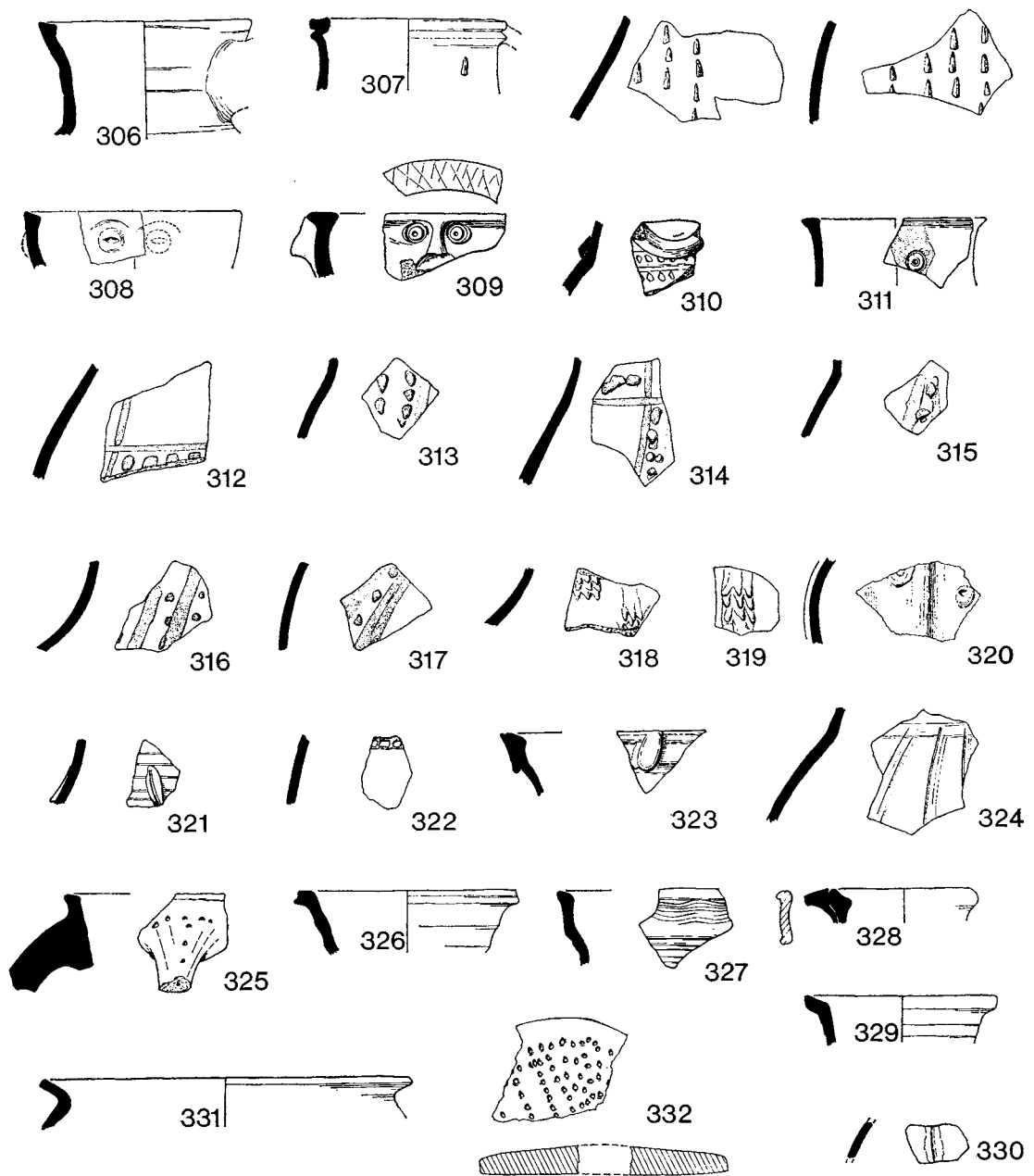

FIG. 97. Pottery from general layers (pp. 173, 177). Scale $\frac{1}{4}$

307. Dark brown glaze, strap handle and applied blobs (possibly same pot as no. 266).
From 89, layer 4.
308. Discontinuous light green glaze; eye made by pressing out the clay from inside.
From 95, layer 61.
309. Thick dark green glaze.
From 67, layer 3.
310. Thick brown glossy glaze. The applied strip is probably the arm of a figure with hands clasped.
From 94, layer 5.
- 311-17. Sherds of identical type: mottled greenish brown glaze over applied strips and pellets of brown clay.
311 from 96, layer 6; 312 from 95, layer 61; 313 from 96, layer 21; 314 from 97, layer 11; 315-17 from 71, layer 5.
- 318-19. Thick mid-green glaze.
318 from 97, layer 11; 319 from 56, layer 5
320. Thick green glaze as above.
From 97, layer 11.
321. Thick dark green glaze.
From 94, layer 5.
322. Speckled green glaze with applied brown clay strip.
From 85, layer 3.
323. Glossy green-brown glaze.
From 71, layer 4.
324. Orange glaze, scored decoration.
From 95, layer 6.
325. Discontinuous speckled light green glaze.
From 80, layer 5.
326. Mottled green glaze.
From 95, layer 6.
- 327-32. Unusual fabrics, probably imported.
327. Off-white sandy ware. Lip fired black, mottled orange-green glaze below neck.
From 80, layer 5.
328. Pink sandy fabric, ochre washed surface.
From 96, layer 20.
329. Buff sandy fabric: pinkish slip.
From 95, layer 6.
330. Hard fine white sandy ware with glossy dark green mottled glaze.
From 94, layer 25.
331. Everted-rimmed vessel in hard pinkish sandy fabric with a pale ochre slip inside and out.
From 95, layer 6.
332. Dish, grey brown sandy ware with stabbed upper surface.

Pottery from the excavations within the grounds of the Priory

In view of the necessarily restricted style of excavations and the disturbed nature of the stratigraphy, few significant medieval groups were recovered. However, large assemblages of sixteenth-century pottery were found in association with the priory buildings in trenches P2 and P8. These have been considered in detail below (pp. 183-8).

Trench P2, layer 20 (fig. 98)

333. Tripod pitcher in fine hard light grey sandy ware with a light green glaze flecked with darker green.

Not illustrated: body sherds of cooking pots in wheel-made sandy fabrics.

Trench P2, layer 22 (fig. 98)

- 334-5. Cooking pots. Wheel-made in hard fine sandy wares, fired reddish-brown on the surfaces.

Not illustrated: body sherds of glazed pitchers.

Trench P2, layer 25

Not illustrated: wheel-turned cooking pots in sandy fabrics tempered with flint grit. One has a thumb-impressed neck cordon.

Trench P7, layer 9

Not illustrated: two sherds of glazed pitchers.

Trench P9, layer 15 (fig. 98)

- 336-8. Cooking pots. Wheel-turned in hard sandy fabrics fired grey. One has spots of glaze on the rim.

Not illustrated: two simple rims in similar fabrics.

339. Pitcher in hard sandy grey ware, fired light red on the surface. Coated with a thick dark green-brown glaze.

Not illustrated: pitcher with thumb-down base.

Trench P9, layer 16 (fig. 98)

340. Cooking pot. Wheel-turned in a hard grey sandy ware.
341. Dish in hard light grey sandy ware with thick internal green glaze.

Not illustrated: body sherds of glazed pitchers.

Trench P17, layer 16 (fig. 98)

342. Pitcher in hard red sandy ware with light green glaze. The spout served as the nose of a face, the eyes of which were applied pellets of clay stamped in circlets.

All of the pottery from these layers belongs to the *late medieval tradition*: fourteenth-century.

Pottery from the Outer Earthwork (trenches 44, 48, 81, 106)*Section 1* (trenches 44, 48)

From layer 5. Redeposited material within the body of the rampart; several sherds of late Saxon cooking pots of the type illustrated in Volume II as nos. 48-60.

From layer 6. The turf line beneath the rampart: body sherds in fabrics similar to the above and also some comparable to the fabrics of Portchester ware.

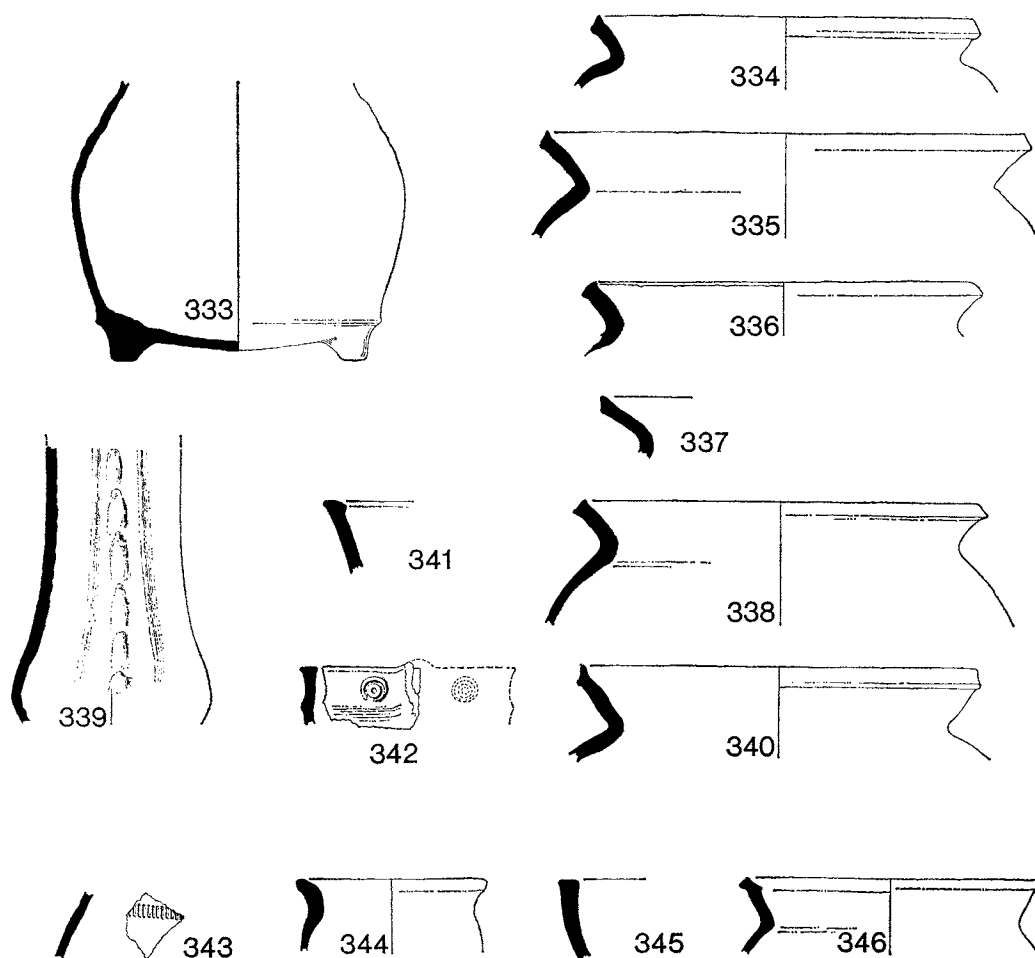

FIG. 98. Pottery from Priory excavations (pp. 178-80). Scale $\frac{1}{4}$

Section 2 (trench 81)

From layer 8. One gritty late Saxon body sherd and another of Saxo-Norman fabric.

From layer 10. One gritty late Saxon body sherd.

From layer 11. One gritty late Saxon body sherd.

Section 3 (trench 106) (fig. 98)

From the turf line below the rampart (layer 10):

343. Fragment of pitcher. Reddish ware with fine flint grits: discontinuous light green glaze.

344. Cooking pot in light grey ware with flint grits.

Not illustrated: body sherds of cooking pots in grey sandy ware with flint grits.

From the body of the rampart (layers 3, 9, 11, 12, 16, 18):

345. Dish, grey sandy ware with flint grits fired reddish on the surfaces.
Layer 16.

Not illustrated: six body sherds of cooking pots in grey sandy fabrics with flint grits.

From the soil accumulation above the rampart tail (layers 4, 5, 7):

346. Cooking pot in fine brown sandy ware.
Layer 5.

Not illustrated: numerous body sherds in similar fabrics.

Not illustrated: pitchers, several body sherds.

The sherds from the turf line and the body of the rampart in section 3 (trench 106) are difficult to date with precision, but are clearly post-Conquest and may be as late as the thirteenth century. The pottery from soil accumulation at the tail of the rampart in the same trench is of fourteenth-century date.

(b) *The Post-Medieval Pottery*

With contributions from JOHN HURST and STEPHEN MOORHOUSE

Three groups of sixteenth-century pottery were recovered, one from gully 9 and two from the priory site. The imported vessels were submitted to Mr John Hurst for comment, while the Tudor Green vessels were examined by Mr Stephen Moorhouse. Their remarks form the basis of the descriptions and general comments offered below.

Gully 9 (figs. 99, 100)

All the vessels come from trench 73, layers 7, 11 and 12.

- 350-7. Parts of eight Raeren drinking mugs (Hurst, 1964, 1967) of various forms and sizes. Nos. 350-2 in a hard light grey stone-ware fabric coated externally and internally with a glossy grey glaze. Nos. 353-7 in a similar fabric with a glossy brown glaze. The glaze of nos. 353-5 is even, though no. 354 shows some mottling; nos. 356-7 are mottled brown and grey.
358. Neck of a South Netherlands maiolica vase (Hurst, 1971). In light cream-coloured fabric with a thick white glaze inside and out. The neck is decorated with parallel blue banding. This feature, while less common than a single band and tendril pattern, can be found on examples in the Guildhall Museum, London (Gateway House, pit 1) and also from Southampton (Platt and Coleman-Smith, 1975) and Kendal Castle (unpublished).
359. Body sherd from the lower portion of a Beauvais jug (Hurst, 1970-1). Hard light cream, slightly sandy ware with an external glossy glaze of golden-yellow with a slight orange mottle.
360. Sherd in a greenish buff fabric with darker inclusions, from various parts of a costrel of Goggin Type I (Goggin, 1960) probably of Spanish origin (Hurst, forthcoming). The fabric is not typical of olive-jar fabric but it is similar in texture and can be compared with other Spanish coarse wares (MacPherson-Grant, forthcoming). While costrels are less common than olive jars, other examples are known (Moorhouse, 1971b).

Not illustrated: sherd from a vessel of Merida type ware (Hurst, forthcoming). The size of the sherd makes reconstruction impossible, but typical forms include a jar and a costrel.

361. Sherd from the flange of a Spanish tin-glazed dish. In soft cream sandy fabric coated with an opaque white tin glaze which had once had lustre decoration (Hurst, forthcoming), now so decayed that it cannot be reconstructed. Despite this considerable deterioration the presence on the back of the dish of a series of concentric circles of much clearer lustre paint prove its presence on the front of the dish.

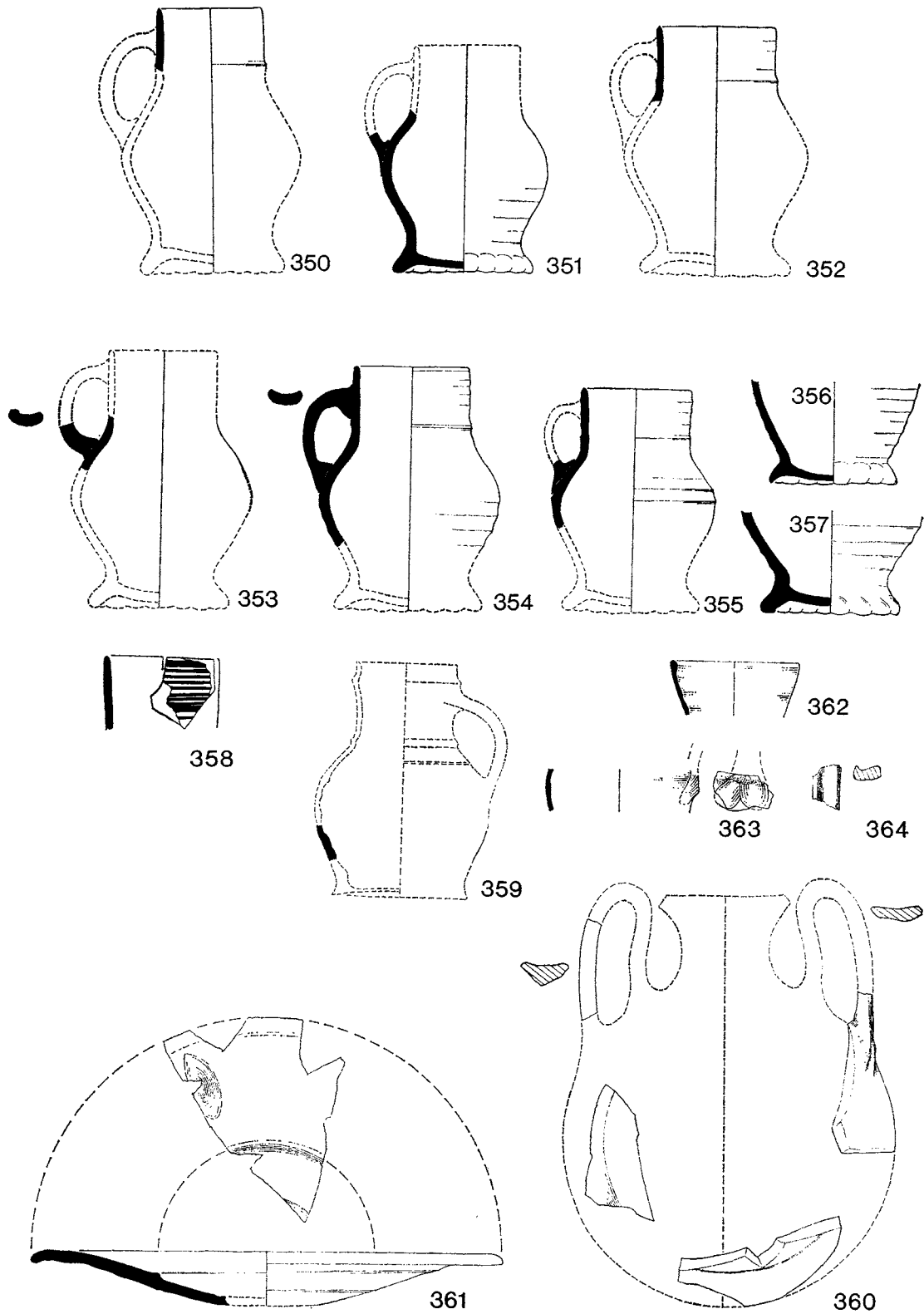

FIG. 99. Post-medieval pottery from gully (pp. 180, 182). Scale $\frac{1}{4}$

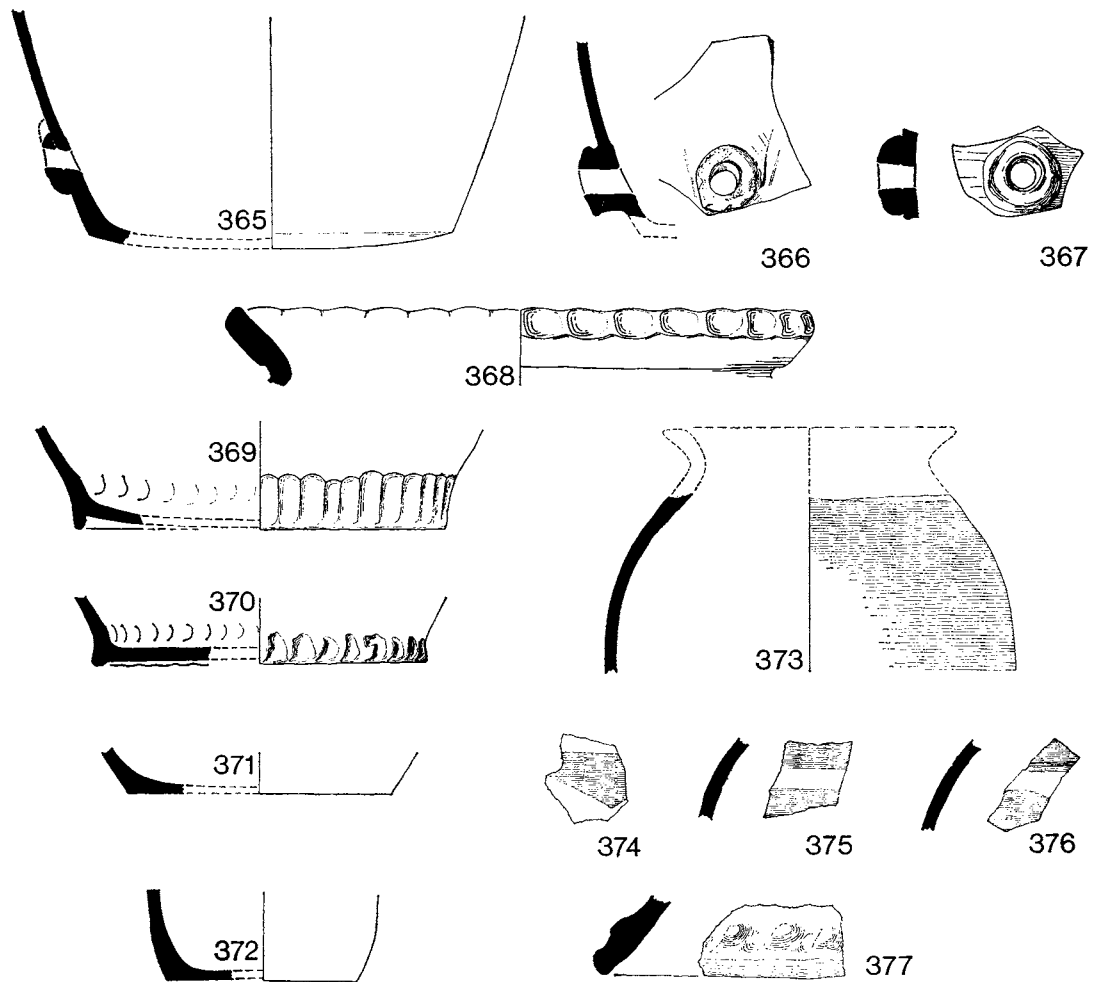

FIG. 100. Post-medieval pottery from gully 9 (pp. 182-3). Scale $\frac{1}{4}$

- 362-3. Two sherds probably from the same Tudor Green vessel. An unusual feature is the thumb impressions at the base of the handle (no. 363); the handles of Tudor Green vessels are normally smoothed into the body where they join at the base. At first glance, the sherds appear to come from a standard type 4 cup (e.g. Cunliffe, 1964, p. 95, fig. 27, nos. 1 and 2). However, the rim diameter is much smaller than the average $4\frac{1}{2}$ in. (0.11 m.) for these vessels, and the neck is tapering in too sharply. A likely reconstruction of this vessel would be as a copy of a typical Siegburg flared necked drinking vessel (Matthews and Green, 1969, p. 13, fig. 2, nos. 25-7). A point against this is that these copies in the Tudor Green range have a sparse watery yellow glaze, while the Portchester example has a glossy rich apple-green glaze all over both sides of the rim, and externally on the body sherd.
364. Handle in Tudor Green ware.
- 365-7. Bung-hole pitchers. Hard sandy fabric fired light red to grey throughout, but grey on the surface. Much knife trimming around the base.

368. Jar with thick everted rim. Smooth grey fabric with sporadic coarse waterworn flint grits. Fired dark grey on the surface.
- 369-70. Thumbed bases of pitchers. Light grey sandy ware fired to light red on the surface.
371. Base: fine grey sandy ware fired light red on the surface. Thick internal green glaze.
372. Base of jug (?). Grey sandy ware fired red on the surfaces, but with the outer surface covered with dark grey slip. Knife trimming at base.
- 373-4. Cooking pots in grey sandy ware fired light red on the surfaces, with the outer surface coated with a dark grey slip painted with white bands.
376. Pitcher (?) in fine grey-brown sandy ware fired dark green on the surfaces.
375. Pitcher (?) in fine grey-brown sandy ware fired dark green on the surfaces.
377. Curfew. Coarse red sandy ware.

From the Priory (trenches P2 and P8) (figs. 101, 102)

378. Sherd of a Raeren drinking mug in hard grey stone-ware with a brown glaze. Trench P2, layer 12.
379. Vessel in Tudor Green ware. These sherds have been reconstructed as coming from the same vessel, although this is by no means certain. They all came from trench P8, four sherds of the bowl and the base sherd from layer 13, with one sherd of the bowl from layer 12. The reconstruction is tentative, since the vessel cannot be paralleled among known Tudor Green forms. It could be argued that the base belongs to no. 387, which was also found in layer 13, but this seems unlikely because the glaze gathering on the base suggests it was fired in the kiln in the position as drawn, while the glaze concentration on the rim of no. 387 suggests it was inverted, rim down, during firing. The bowl, no. 379, was initially interpreted as the shoulder of a costrel, but this cannot be so from the production point of view. The outer profile has been thrown in one piece, and then the base luted inside; this would have been impossible, and unnecessary, had it been an enclosed costrel or flask. The interior of the bowl has no glaze in the base below the 3 in. (0.08 m.) diameter line, possibly suggesting that the upper part of the bowl had a constricted mouth, as in the standard form of early post-medieval Surrey Ware perfume pot (Moorhouse, 1970). The decoration on the base has been formed by cutting out vertical pieces of triangular section; this method is shown by the knife cuts below the profile of the grooves, seen in the plan view of the sherd. The actual function of the vessel is uncertain but it could possibly have been a perfume pot or a chafing dish. Trench P8, layer 13.
380. Jug in Tudor Green ware. Two joining sherds. The sherds come from a standard Surrey jug, these jugs being incorporated within the Tudor Green range, and continuing through into the seventeenth century (Matthews and Green, 1969, pp. 7-8). The vessel was fired in an upright position within the kiln, but at a steep angle to the vertical, as shown by the glaze drip on the handle. The angle of the handle suggests that the body was bulbous as reconstructed and not one of the tall, slender, jugs. Trench P8, layer 13.
381. Single rim sherd, possibly from a small bottle. Bottles were a product of the late medieval Surrey kilns, but were included within the Tudor Green range, along with other traditional Surrey forms, like the money-box and drinking jug. Trench P2, layer 17.
382. Single sherds from two Tudor Green vessels, possibly from some form of corrugated cup.¹

¹ The various forms of these cups can be seen from the no. 8) and from the group from Overton (Moorhouse, 1971, George Hotel pit, Winchester (Cunliffe, 1964, p. 95, fig. 27, p. 183, fig. 63).

EXCAVATIONS AT PORTCHESTER CASTLE

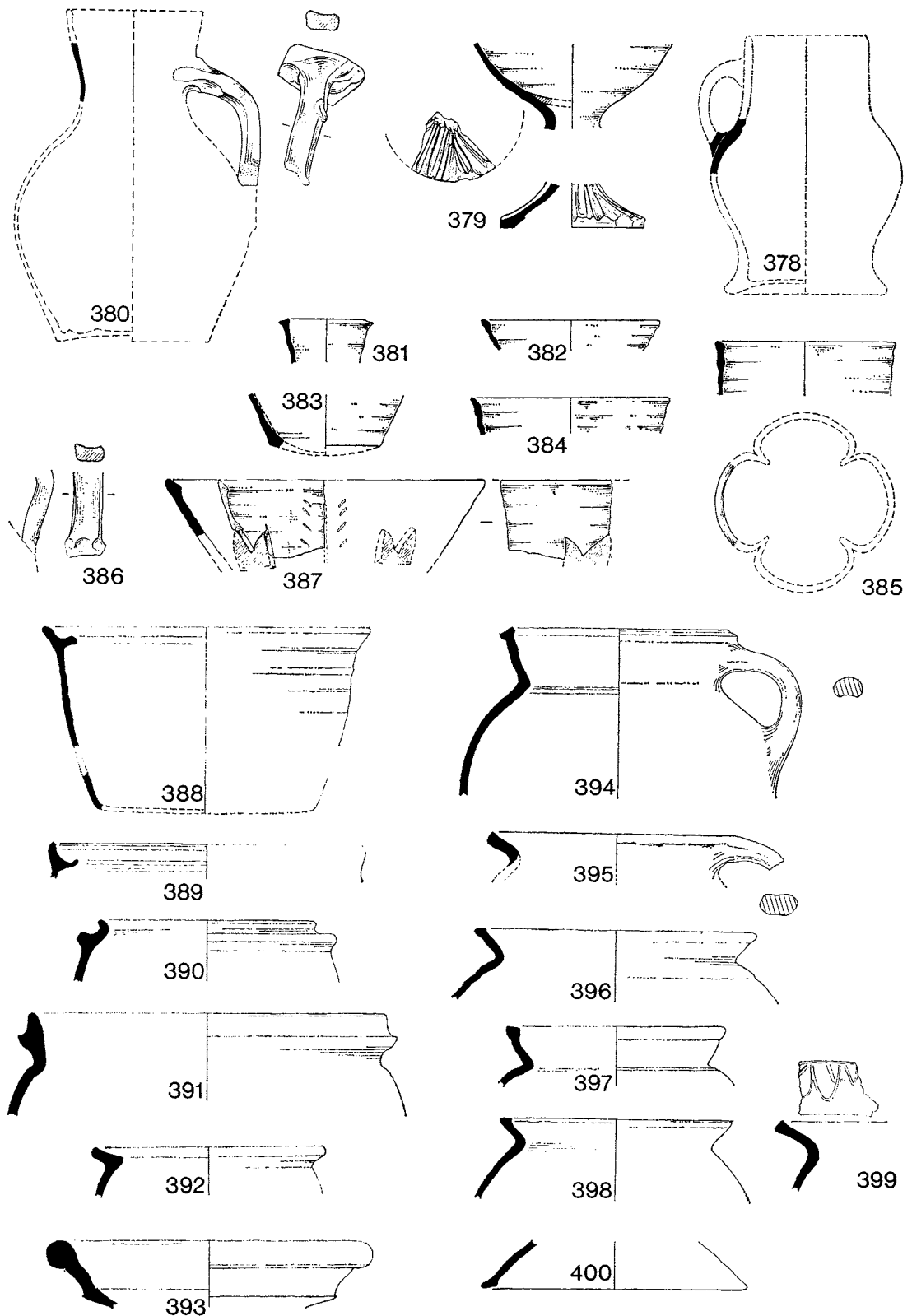

FIG. 101. Post-medieval pottery from the Priory excavations (pp. 183, 185, 187). Scale $\frac{1}{4}$

384. This is suggested by the rilling of the body below the rim.
Trench P8, layer 13.
383. Base sherd with deep glossy green glaze. The body has been partially reduced to a light grey, and the inner surface has flaked off. This sherd appears to be from a copy of a Tudor Green vessel, as the fabric is slightly coarser than normal and genuine wares are never reduced. The body is thicker than usual and Tudor Green vessels never have sagging bases. Distinct Tudor Green shapes were being copied by native potters, even as far away as Yorkshire¹ and the western Midlands, e.g. Worcester (Barton, 1965; Barton, 1969b, pp. 85–88).
Trench P8, layer 10.
385. Vessel of Tudor Green ware. This piece is formed by two joining sherds. The piece is problematical. Its rim circumference is not completely circular, and the wall is only vertical, as drawn, in the centre of the remaining piece; the wall at the lower end of the plan view is curving inwards slightly. There are at least two possible reconstructions. The most likely is perhaps as a four-lobed type 4 cup, the sherd coming from the centre of one of the lobes. A complete example, minus both handles, is in the British Museum.² The rim of another quatrefoil cup comes from a large Tudor Green group found in a garderobe at Newport Castle, Monmouthshire.³ It is possible that a number of these type 4 quatrefoil cups have in the past been reconstructed as open-mouthed lobed cups. Their lobes are characterized by the tall, near vertical necks, in contrast to the short, invariably flared necks of the lobed 'bowls'.⁴ An alternative suggestion is that the Portchester piece comes from a cruet with two or more compartments, the sherd coming from a bowl with a 3 in. (0.08 m.) diameter, near the junction of the two bowls. A double cruet of this form comes from Basing House in a post-c. 1540 context, with a handle spanning the shorter compartment (Moorhouse, 1970, p. 60, fig. 14, no. 132). Three-bowled cruets are known from various sites in the City, and are housed in the Museum of London. All these examples have a rich glossy internal glaze, as would be expected for holding condiments on a table; the Portchester piece is glazed internally only on the top $\frac{1}{2}$ in. (0.01 m.) of the rim.
Trench P2, layers 12, 16.
386. Strap handle from a Tudor Green jug, larger in size than no. 380.
Trench P2, layer 12.
387. Tudor Green vessel: two joining sherds. The sherd has internal incised decoration of either a (?) leaf or (?) fern pattern, with combined triangular cut-outs in the wall, and is covered all over, both internally and externally, in a thick glossy green glaze. Both internal decoration and the internal glazing suggests that this piece is not from a lid, but the wall and rim from a flared bowl of a vessel. The profile of the vessel is uncertain, but possibly the bowl surmounted a pedestal in the form of a (?) perfume pot.
Trench P8, layer 13.

¹ At least two centres in southern Yorkshire were copying Tudor Green forms. A fifteenth-century kiln deposit from the Rawmarsh kilns produced a very crude white-ware pedestal base, in contrast to the normal gritty ware products (Crossley, Lewis and Moorhouse, forthcoming); there was also another fifteenth-century centre specializing in copies of exotic forms in a fine red-ware in south Yorkshire, as evidenced by the recent excavations at Sandal Castle, near Wakefield (Moorhouse, forthcoming).

² Found with a Surrey Ware bung-hole pitcher near the frontage of no. 13 Cheapside, London, in 1899; acc. no. B245. I am grateful to Mr John Cherry for the details of

this vessel. It is mentioned in R. L. Hobson, *Catalogue of the Collection of English Pottery in the British Museum* (B.M. Guide, 1903), no. B245.

³ The publication of the material from Newport Castle is in preparation by the writer and J. K. Knight for a future volume of *The Monmouthshire Antiquary*.

⁴ See the Tudor Green lobed cups from the Inns of Court (Matthews and Green, 1969, p. 15, fig. 3, nos. 39); from the George Hotel, Winchester (Cunliffe, 1964, p. 95, fig. 27, nos. 4 and 5); and from Writtle (Rahtz, 1969, p. 103, fig. 56, nos. 80, 89 and 90).

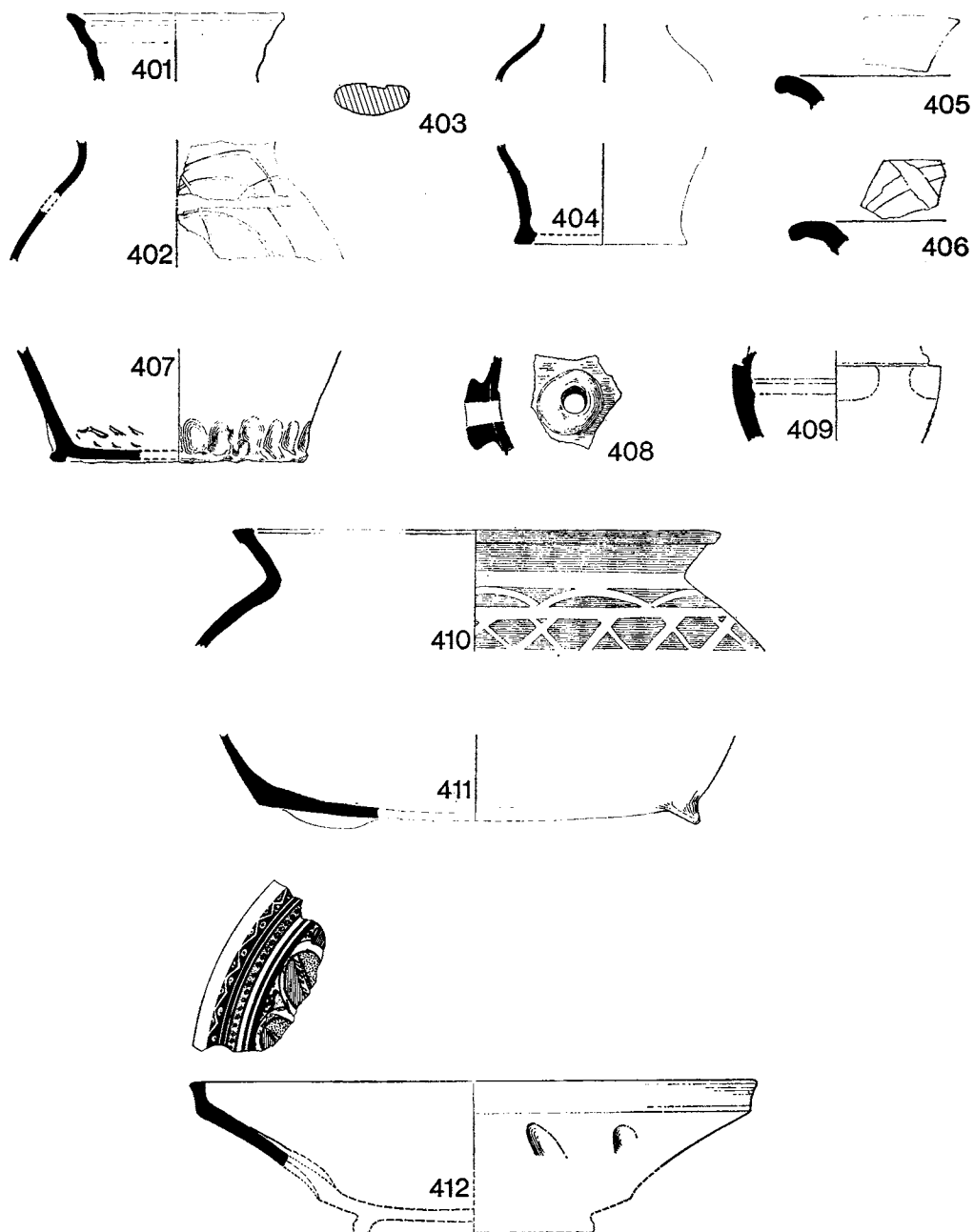

FIG. 102. Post-medieval pottery from the Priory excavations (nos. 401-11), and unstratified (no. 412). (pp. 187-8). Scale $\frac{1}{4}$

388. Bowl with internal flange. Hard grey sandy ware fired ochre on the surfaces. The lower part of the interior is covered with a thick green-brown glaze.
Trench P8, layer 12.
389. Bowl with internal flange, hard sandy buff ware.
390. Bowl with externally ledged rim, in hard grey sandy ware fired red on the surfaces. The interior is coated with a discontinuous green-brown glaze.
Trench P8, layer 10.
391. Necked vessel in hard grey sandy ware fired red on the surfaces. The interior is coated with a thick green glaze.
Trench P2, layer 5.
392. Bowl in hard grey sandy ware, partially oxidized. Thick brown glaze internally and over the rim surface.
Trench P2, layer 12.
393. Dish in hard grey sandy ware with a thick internal brown glaze.
Trench P8, layer 13.
394. Handled vessel in grey sandy ware with a discontinuous green glaze inside and over the inner surface of the rim.
Trench P8, layer 12.
395. Handled vessel in hard grey sandy ware.
Trench P2, layer 12.
396. Everted-rimmed vessel in hard light grey sandy ware fired ochre on the outer surface. The inner of the rim is coated with a thick glossy light green glaze.
Trench P2, layer 12.
397. Everted-rimmed vessel in hard grey sandy ware with discontinuous spots of green-brown glaze internally on the rim.
Trench P8, layer 13.
398. Everted-rimmed vessel in hard grey sandy ware.
Trench P2, layer 14.
399. Everted-rimmed vessel in hard grey sandy ware. Discontinuous green-brown glaze on inside surface of rim.
Trench P8, layer 13.
400. Lid in red sandy ware.
Trench P2, layer 12.
- 401-2. Jug in hard grey sandy ware with slightly oxidized surface. External green-brown glaze. The rim and body sherds may be part of the same vessel.
The rim is from trench P8, layer 12, the body sherds from layer 10.
403. Jug handle in grey sandy ware with discontinuous external green-brown glaze.
Trench P8, layer 13.
404. Base and shoulder sherds from an early sixteenth-century Beauvais stone-ware jug (Morisson, 1968, 18, fig. 3), typical of the Savignies kiln (Morisson, 1970-71, 43-73). It is extremely difficult to distinguish this stone-ware from Siegburg, except where, as in this case, the base is present, Beauvais stone-ware having a characteristic splayed base completely different from the frilled base of Siegburg stone-ware. Therefore while body sherds may remain undetected a number of examples have been found in excavations in this country (Platt, 1962, 220).
Trench P2, layers 12 and 14.

- 405-6. Dishes in fine grey sandy ware with oxidized surfaces, painted white.
Trench P2, layer 12.
407. Jug base in hard light grey ware, slightly oxidized. One small glaze spot outside on the bottom.
Trench P8, layer 12.
408. Sherd of bung-hole pitcher in hard light grey sandy ware, slightly oxidized.
Trench P2, layer 12.
409. Vessel of uncertain type in coarse grey sandy ware. The shoulder is slightly faceted.
Trench P8, layer 10.
410. Everted-rimmed vessel in hard light grey sandy ware, with both inner and outer surfaces coated with dark grey slip. The outer surface is painted white with some traces of green glaze.
Trench P2, layer 5.
411. Base of vessel with ledged feet in hard light red sandy ware.
Trench P2, layer 19.
412. Dish in sixteenth-century Tuscan maiolica characterized by the usual decor of bright colours, overglaze enamel and sgraffito through blue decoration (Mallett, 1972). Unstratified from the clearance operation of 1930.

(c) *The Tudor Green Wares*

BY STEPHEN MOORHOUSE

The Tudor Green wares from Portchester can be divided into three associated groups; one from gully 9 beneath the storehouse and two from the priory site. Three sherds, two probably from the same vessel, were found in the material sealed by the construction of the storehouse in 1521 (nos. 362-4). A much larger collection of vessels was found on the priory site. The material came from two separate trenches (P2 and P8). It is unfortunate that the dating evidence from Portchester is so meagre, with only two vessels coming from the firmly dated storehouse make-up levels, while the majority of the vessels were undated, other than being of general pre-Dissolution date, with the exception of no. 383.

The fabric and glazing of the various Tudor Green vessels from the castle and priory are consistent. The fabric is very fine grained and creamy white in colour with very light yellow waxy surfaces. The glaze is glossy, rich apple-green when thick, but showing light yellow mottling when watery. The glaze has collected or fossilized in drips on a number of vessels, indicating their firing postures in the kiln. No. 370 was upright but tilted sideways, as shown by the concentration on the right side of the handle. No. 387 was fired upside down as is the case with most cup forms, as there is a heavy concentration of dark coloured glaze (the colouring caused by the thick deposit) uniformly gathered on the rim top.

The Tudor Green itself can add little to the general dating evidence for the contexts in which they were found. It was once thought that Tudor Green had a relatively short life, restricted to the sixteenth century, but recent evidence has shown its existence in early fifteenth-century contexts, and its origins may lie even earlier. The jug shapes and goblets were still being produced by the sixteenth-century potters who were making the truly post-medieval

Surrey white-ware wares, as at Farnborough Hill.¹ The forms were, however, not present amongst the kiln groups from Ash and Hawley, dating to around the middle of the seventeenth century (Holling, 1971, p. 76). The Tudor Green potters not only produced a range of standard forms,² but also a very wide range of less common shapes, a repertoire which is constantly being added to by newly discovered groups. It is in this latter respect that the Portchester assemblage is important. The study of Tudor Green has not advanced sufficiently to be able to give date ranges to these individual forms. This will only be achieved by the location and excavation of kiln sites, married with the material from well-documented and stratified groups.

Recent work has advanced our knowledge of Tudor Green in this country. Archaeological evidence has shown that it was available over a wide area by the second quarter of the fifteenth century. Documentary evidence has suggested that white-ware cups were in wide circulation by the 1420s. In 1972 Mr Felix Holling excavated a kiln at Farnborough Hill,³ north of Farnham, producing Tudor Green, confirming the existence of production centres in this country for this distinctive ware. This combined evidence for Tudor Green will be discussed elsewhere (Moorhouse, forthcoming). It is unfortunate that the Portchester Tudor Green cannot be internally dated, but it is gratifying that some of the forms found on the site add to the ever growing range of shapes known to have been produced by the Tudor Green potters.

CURFEWS

(fig. 103)

BY GERALD DUNNING

Unglazed Curfews (nos. 143, 192, 254, 347)

The four fragments are consistent in fabric; grey sandy ware tempered with flint grits, and fired red on the surface. In this way they differ from the light red fabric with different inclusions of no. 348, suggesting two sources for the curfews found at Portchester.

The two handles (nos. 143 and 347), both of wide strap-like section, are of the one-handled type bridging the top that is usual in Britain. No. 347 has vents at the ends of the handle, which also have parallels widely in the southern counties and as far north as Yorkshire.

It is satisfactory to have the sides and lower margins of two curfews (nos. 192 and 254). Both have horizontal thumb-pressed strips, which again are a feature on this type in the region, e.g. at Winchester and Laverstock.

The context of the Portchester curfews, in the thirteenth and fourteenth centuries, conforms with the main period of these fittings elsewhere. Finer sub-division must await further dis-

¹ An interim note in *Post-Med. Arch.* vii (1973), 111; material in Guildford Museum and see Holling (1971), p. 75, fig. 3, D1 for the jugs, and p. 73, fig. 2, for the goblets; they are discussed on pp. 76 and 74 respectively. The Guildhall pit groups, collections of associated material from many parts of the City, suggest that the post-medieval forms were emerging by the middle of the sixteenth century, if not earlier.

² These commonly found forms can be seen in Brears (1971, p. 24), with the exception of no. 9, which is not commonly found in fifteenth- and sixteenth-century contexts.

³ An interim note is in *Post-Med. Arch.* vii (1973), 111; material in Guildford Museum, seen with the kind permission of Mr F. W. Holling in advance of his own publication.

EXCAVATIONS AT PORTCHESTER CASTLE

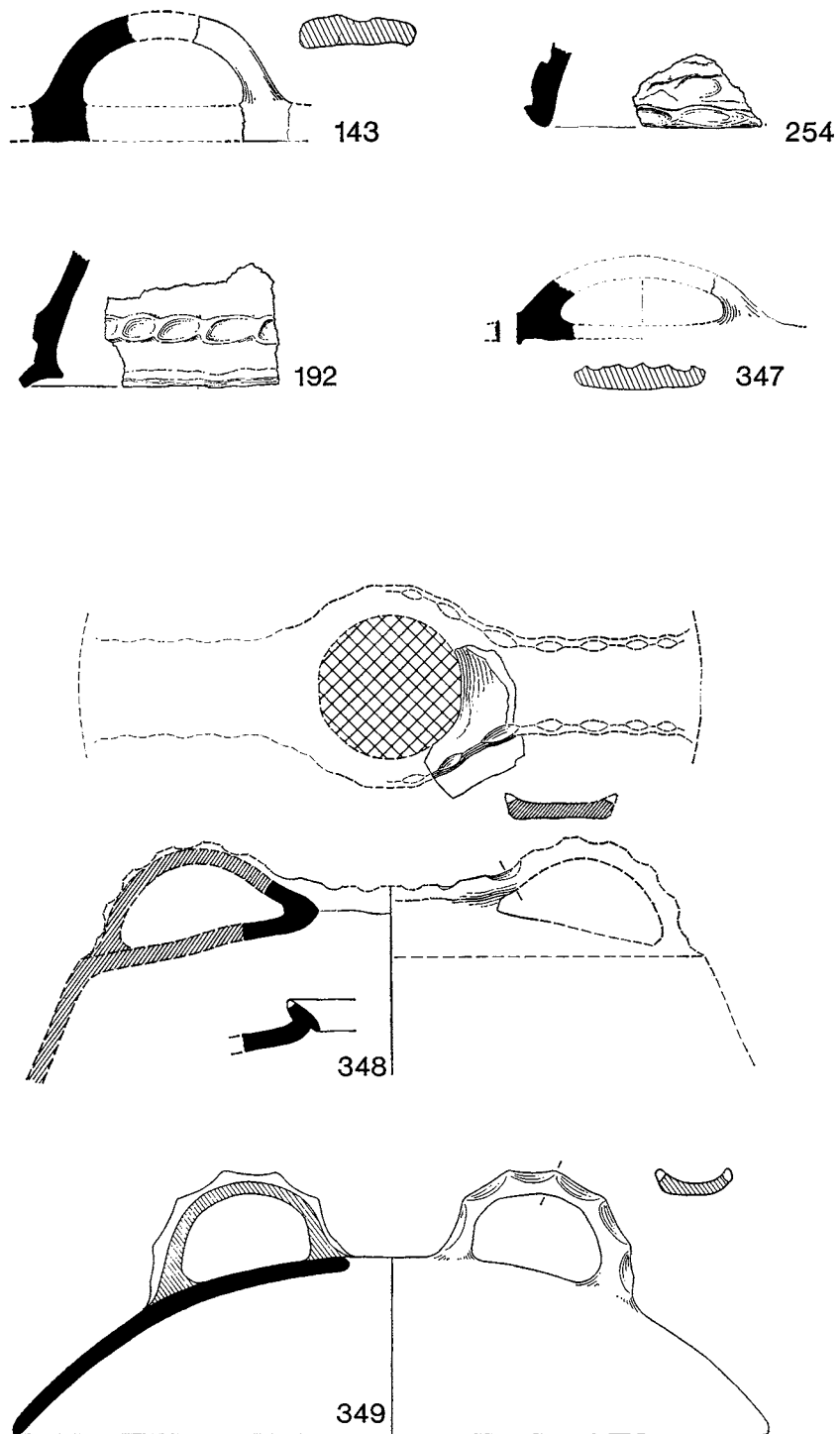

FIG. 103. 143-347, fragments of curfews, Portchester Castle; 348, restoration of upper part of curfew, Portchester Castle; 349, curfew from Mariakerke or Raversyde, near Ostend (pp. 189, 191-2). Scale $\frac{1}{4}$

coveries, though the complex section of the margin of no. 192 appears to be a development in the fourteenth century rather than earlier.

- 143 from pit 132 — thirteenth-century.
- 192 from gully 8 — fourteenth-century.
- 254 from occupation layers associated with building M2.
- 347 from trench 100, layer 28.

Glazed Curfew (no. 348)

The fabric has diverse inclusions; angular crushed flint, black flint or stone, opaque white stone, and also particles of red tile. The fractures are light red throughout. The surfaces are dark brownish red; the outside is partially glazed green with darker speckles, thicker and more evenly on the surface below the handle. The inside is partly stained grey, presumably by deposit from smoke.

As seen from above, the sherd has part of a hole, roughly circular and about 3 in. (7.7 cm.) in diameter. The attachment of a strap-handle rises from the side of this hole. Laterally, the margin of the aperture has a splayed rim (see lower section), marked by elongated finger-tip impressions, which are continued along the edges of the handle.

The identification of this sherd was a problem. Its features could not be matched by those of any known roof-fittings (though some louvers have apertures of this shape and size, but no handles). Neither could it be recognized as any form of domestic vessel. Eventually and because of the smoke stain on the inside, it was decided that the sherd belonged to an unusual type of fire-cover, and the drawing was completed accordingly.

As restored in fig. 103, the arched handle extended laterally to the edge of the domed top, giving this a diameter of about 13 in. (33 cm.), which is within the range known in Britain. The size and weight of the fire-cover would require two handles for lifting, so another has been drawn on the opposite side of the central hole.

Thus the Portchester fire-cover differs from the normal type, which has a single strap-handle across the top, sometimes extending nearly the whole width of the dome.¹ Vents of varying size are present at both ends of the handle, elsewhere on the top, or only centrally in the dome beneath the handle. Hitherto the curfews in Holland have been quoted as the counterparts of those in England, since these have one strap-handle and the position of the vents is similar. Recently, however, the incidence of curfews has been extended to central Belgium and extreme northern France; in these regions the vents are hooded, and placed near the upper part of the side (Barton, 1974, p. 171, fig. 8, no. 31).

Although less well known, the fire-covers in West Flanders are the most relevant to this discussion. The finds are from hamlets at Mariakerke and Raversyde, on the coast to the west of Ostend, which were largely destroyed by the sea in the tempest of 1334. Among the pottery from these sites, in the Musée d'Histoire locale at Ostend, are fire-covers which may be correlated with the hearths in the dwellings (Chocqueel, 1950, fig. 10 and pl. IV). One of the covers is here illustrated from a sketch made during a short visit to the museum in 1960 (fig. 103, no. 349). It is made of unglazed grey ware, almost hemispherical in form, with a

¹ Northolt Manor (Hurst 1961, p. 265, fig. 69, no. 85); Laverstock (Musty, Algar, and Ewence 1969, p. 138, fig. 23, no. 195). References to Dutch fire-covers are given in these reports.
 Hangleton (Holden 1963, pp. 135-8, fig. 27, no. 244);
 Winchester (Cunliffe 1964, pp. 126, fig. 45, nos. 1-2);

single central hole in the top. One complete strap-handle, deeply finger-impressed along both edges, is at one side of the hole. The opposite side is imperfect, and could not be closely examined at the time. Thus the second handle, added in the drawing, is probable but not certain. With this reservation, the upper part of the fire-covers in West Flanders provide the closest analogy abroad for the sherd from Portchester.

BIBLIOGRAPHY

- BARTON, K. J. 1963. 'A Late Fifteenth-century Well at Tarring.' *Sussex Arch. Coll.* ci, 28-34.
- BARTON, K. J. 1964. 'Excavations in the Village of Tarring, West Sussex.' *Sussex Arch. Coll.* cii, 11-27.
- BARTON, K. J. 1965. 'An Early Post-medieval Group from Nudix Court, Worcester.' *Post-Medieval Ceramic Research Group, Broadsheet* 3.
- BARTON, K. J. 1966a. 'The Medieval Pottery of Paris.' *Med. Arch.* x, 59-73.
- BARTON, K. J. 1966b. 'Medieval Pottery at Rouen.' *Arch. Journ.* cxxii, 73-85.
- BARTON, K. J. 1969a. 'Three Groups of Medieval Jugs and their Wider Significance.' *Proc. Hants Field Club*, xxiv, 62-70.
- BARTON, K. J. 1969b. 'The Contents of Three 16th-Century Pits from Broad Street, Worcester.' In Philip Barker, 'The Origins of Worcester' (*Trans. Worcester. Arch. Soc.* 3rd series, ii, 85-88).
- BARTON, K. J. 1970. 'The Products (of the Medieval Kiln in Orchard Street).' In Down, A. and Rule, M., *Chichester Excavations*, 1 (Chichester), pp. 153-7.
- BARTON, K. J. 1974. 'The Medieval Blackwares of Northern France.' In Evison, V. I., Hodges, H. and Hurst, J. G. (eds.), *Medieval Pottery from Excavations* (London), pp. 167-81.
- BIDDLE, M. and BARCLAY, K. 1974. 'Winchester Ware.' In Evison, V. I., Hodges, H. and Hurst, J. G. (eds.), *Medieval Pottery from Excavations* (London), pp. 137-65.
- BREARS, P. C. D. 1971. *The English Country Pottery: Its History and Techniques* (David and Charles).
- CHOCQUEEL, A. 1950. *Les Civilisations préhistoriques et anciennes de la Flandre occidentale* (Brussels), pp. 81-100.
- CROSSLEY, D. W., LEWIS, G. D. and MOORHOUSE, S. (forthcoming). 'A Late Medieval Pottery Kiln Site at Rawmarsh, Yorkshire.' *Yorks. Arch. J.* xlviii.
- CUNLIFFE, B. W. 1964. *Winchester Excavations 1949-1960*, Volume I (Winchester).
- CUNLIFFE, B. W. 1973. 'Manor Farm, Chalton, Hants.' *Post-Med. Arch.* vii, 31-59.
- DOWN, A. 1970. 'A Medieval Kiln in Orchard Street.' In Down, A. and Rule, M., *Chichester Excavations*, 1 (Chichester), pp. 153-7.
- DUNNING, G. C. 1972. 'Two fire-covers from Langstone Court, Monmouthshire.' *Med. Arch.* xvii, 57-61.
- FENNELLY, L. R. 1969. 'A Late Medieval Kiln at Knighton, I.o.W.' *Proc. Hants Field Club*, xxvi, 97-110.
- GOGGIN, J. M. 1960. *The Spanish Olive Jar*. Yale University Publications in Anthropology, no. 62.
- HOLDEN, E. W. 1963. 'Excavations at the Deserted Medieval Village of Hangleton. Part I.' *Sussex Arch. Coll.* ci, 52-181.
- HOLLING, F. W. 1971. 'A Preliminary Note on the Pottery Industry of the Hampshire-Surrey Borders.' *Surrey Arch. Coll.* lxviii, 57-88.
- HURST, J. G. 1961. 'The Kitchen Area of Northolt Manor, Middlesex.' *Med. Arch.* v, 211-90.
- HURST, J. G. 1964. 'Stoneware Jugs.' In Cunliffe, B. W., *Winchester Excavations 1949-1960*, volume 1 (Winchester), pp. 142-3.
- HURST, J. G. 1967. 'Pottery Report.' In Keene, L., 'Excavations at Old Wardour, Wilts.' *Wilts. Arch. and Nat. Hist. Soc. Mag.* lxii, 74-8.

- HURST, J. G. 1970-1. 'Sixteenth-century Beauvais Drinking-Jugs.' *Groupe de Recherches et d'Etudes de la céramique du Beauvaisis*, Bulletin no. 3, pp. 6-15.
- HURST, J. G. 1971. 'South Netherlands Maiolica.' In Beresford, G., 'The Old Manor at Askett.' *Rec. of Bucks.* xvii, 362-4.
- HURST, J. G. (forthcoming). 'Spanish Pottery into Medieval England.' *Med. Arch.* (forthcoming).
- MACPHERSON-GRANT, N. (forthcoming). 'Stonar Excavations.' *Med. Arch.* (forthcoming).
- MALLETT, J. V. G. 1972. 'L'importazione della Maiolica Italiana in Inghilterra.' *Atti V Convagno Internazionale della ceramica* (Albisola), pp. 251-6.
- MATTHEWS, L. G. and GREEN, H. J. M. 1969. 'Post-medieval Pottery of the Inns of Court.' *Post-Med. Arch.* iii, 1-17.
- MOORHOUSE, S. 1970. 'Finds from Basing House (c. 1540-1645). Part I.' *Post-Med. Arch.* iv, 31-91.
- MOORHOUSE, S. 1971a. 'A Sixteenth-century Tudor Green Group from Overton, Hampshire.' *Post-Med. Arch.* v, 182-5.
- MOORHOUSE, S. 1971b. 'Excavations at Sawtry St Judith.' *Camb. Antiq. Soc.* lxxiii, 75-86.
- MOORHOUSE, S. forthcoming. 'The Medieval Pottery.' In Mayes, P., *Excavations at Sandal Castle, Yorkshire: 1964-1973*, 3 volumes (Leeds).
- MORISSON, H. 1968. 'Histoire sommaire de la poterie du Beauvaisis.' *Groupe de Recherches de la céramique du Beauvaisis*, Bulletin no. 1.
- MORISSON, H. 1970-71. 'Céramiques du Beauvaisis découvertes anciennement à Bourges et conservées aux Musées de Bourges.' *Groupe de Recherches de la céramique du Beauvaisis*, Bulletin no. 3, 43-73.
- MUSTY, J., ALGAR, D. J. and EWENCE, P. F. 1969. 'The Medieval Pottery Kilns at Laverstock, near Salisbury, Wiltshire.' *Archaeologia* cii, 83-150.
- PLATT, C. 1962. 'Excavations at Dartington Hall.' *Arch. J.* cxix, 208-24.
- PLATT, C. and COLEMAN-SMITH, R. 1975. *Excavations in Medieval Southampton, 1953-1969*, vols. 1 and 2 (Leicester).
- RAHTZ, P. A. 1969. *Excavations at King John's Hunting Lodge, Writtle, Essex: 1955-1957*. Soc. Med. Arch. Mono. Ser., no. 3.
- VIDLER, L. A. 1934. 'Medieval Pottery and Kilns found at Rye.' *Sussex Arch. Coll.* lxxiv, 45-64.

VII. SMALL OBJECTS

THE ARMOUR FRAGMENTS

(pls. XL, XLI)

BY H. RUSSELL ROBINSON

THREE forms of armour are represented by fragments 1 to 11. 1-4 are from defensive garments known as brigandines, 5 is a strip of mail, and 6-11 are elements of laminated armour, either from upper arm or pendant thigh guards.

Fragments 1-4 are from three different brigandines; 1-2b are from one and 3 and 4 from two late examples.

The brigandine was a doublet-shaped garment of fabric, generally of canvas or coarse linen faced with a finer, coloured material such as velvet, silk or wollen cloth according to the quality of the defence and the rank of the man for whom it was made. The plates were secured with rivets to the inside in vertical rows against the coarse lining and the rivet heads, tinned or gilded, powdered the surface of the outer coloured fabric. It was customary to tin the iron plates to prevent rusting and the consequent decay of the fabric; the plating of the rivets served the same purpose as well as being decorative (cf. pl. XLIIa). The absence of other portions of the brigandines suggests that they were discarded fragments from old and worn-out specimens, probably kept in a store for the repair of others.

Fragments 1-2b have rosette-headed rivets similar in size to those used on late fourteenth- and fifteenth-century examples found at Stonar in Kent and at Coldingham Priory in Berwickshire (Noble, 1970, p. 210, fig. 2). The heads are approximately 8 mm. in diameter.

The rivets on fragment 3 are of brass and on fragment 4 of iron but both have heads of approximately 6 mm.; a size common to most sixteenth-century brigandines.

Fragment 1 is approximately 16.20 by 4.40 cm. with a curve running evenly throughout its length. There are five rivets evenly spaced at about 2 cm. apart and a sixth, 3.20 cm. from the last of these, along one edge and four on the other. Two of these last are 2.40 cm. apart at the left hand end and the second pair 4.70 cm. from the first and 4 cm. from each other. This riveting suggests a plate in the lower edge of the skirt of a brigandine.

Fragments 2a and 2b may be part of one narrow plate or two smaller ones; 2a is 6.40 cm. long and 3.10 cm. at its widest part, whilst 2b is 6 cm. long and 3.10 cm. at its widest point. The rivets are placed along one edge at distances varying from 1.20 to 1.50 cm. from each other. This long edge against which the rivets are placed would be the upper edge when secured within the garment. Both plates are curved on their long axis.

Traces of the coarse lining fabric are to be seen in the proximity of the rivet heads on these three fragments.

The size of the rivets and the length of the plates suggest a date in the late fifteenth century or, at the latest, the first quarter of the sixteenth century for these fragments. Unfortunately no exact parallels can be cited at this time. Brigandine plates vary in size and shape with their position in the garment, but it is also possible to say that they begin as quite large

plates with the earliest examples found in the graves from the battle of Wisby in Gotland in 1361 (Thordeman, 1939), and steadily decrease in size until the sixteenth century is reached. The plates then become a reasonably standard size, being approximately 4.60 by 2.70 cm., though there is some variation according to their position in the garment. A number of complete sixteenth-century brigandines survive in museums throughout Europe.¹

Fragment 3 is 7.30 cm. long and 3.80 cm. wide. The rivets are placed in a close line of seven against the upper long edge, with a single rivet below each of the end rivets. The upper row of rivets begins 1.70 cm. in from the left hand edge, indicating that it was overlapped by the next row of plates on that side. Its right edge overlapped in turn the next vertical row of plates, all of these rows having their plates overlapping upwards.

Fragment 4 is 8.70 cm. in length, 4.7 cm. in width. The iron rivets are similarly placed to those on fragment 3 but are in a single line only.

Both fragments 3 and 4 suggest by their size and manner of riveting that they may be dated to the first quarter of the sixteenth century.

Fragment 5 is a strip of mail now corroded into a solid piece of iron oxide. The rings may have been originally about 8 cm. in diameter and each ring would have been joined by a small rivet. Such a fragment could have been used for lining a jack, a similar garment to a brigandine but generally a much coarser and cheaper defence worn by the common soldier. It consisted of a doublet of two layers of strong hessian or canvas with square plates laced in between in overlapping rows. Some were however lined with pieces of mail, also laced with cord, but in some cases the body of the garment was lined with plates and the skirt with mail. If sleeves were provided, these might be lined with mail. Narrow strips of mail were also used on the shoulders and at the necks of brigandines to form collars, and the fragment in question might have been used for either purpose.² It could equally well have been cut from a mail shirt in the course of alteration such as the reduction of the length of a sleeve or skirt.

The fragments 6-11 are all iron laminations of similar character, but their purpose can be deduced from their width and curvature.

Fragment 6 consists of three plates now bonded together by oxide, and may have once formed part of a pauldron or shoulder defence, their original position being between the main shoulder plates and the upper-cannon of the vambraces which defended the arm above the elbow. Their curve and width is suitable for this part of an armour.

Fragment 7 is almost certainly part of a tasset or pendant thigh guard attached by straps to the fauld or skirt of the breastplate. The plates were joined by rivets working in slots at the outer edge with internal leathers at the centre and inner edges.

Fragment 8 may be part of the same three plates as fragment 6 or of a similar element.

Fragments 9, 10 and 11 would also suggest horizontal tasset laminations curved to fit round the thigh, and 9 exhibits well the manner in which laminations can become crossed over each other when the leathers at the centre and inner edge have broken or been removed. As far as it is possible to judge from these corroded fragments, one would suggest that the

¹ London, Tower of London Armouries; Paris, Musée de l'Armée; Vienna, Waffensammlung, Kunsthistorisches Museum; Madrid, Armeria Real; New York, Metropolitan Museum of Art.

² See sixteenth-century brigandines in Tower of London Armouries, nos. III-1453, III-1454.

armour was of munition quality. Whether they formed elements of cavalry armour or corselets for the foot it is impossible to tell, for no distinguishing portions survive, and whatever their purpose may have been, their like can be found at any time in the sixteenth century. They are unfortunately portions of an armour of munition quality which change very little between 1500 and 1620 (see pl. XLII*b*). If one element had been complete and provided a vital outline or detail of a border, we might then have had something with which to date with greater accuracy this group of armour fragments. Like the brigandine plates, these laminations would appear to be discarded, possibly damaged plates, which were being kept for patching or repairing armour then in use.

Nos. 3–10 were found in gully 9 (trench 73, layers 7 and 11 and trench 98, layer 15) in a deposit of rubbish dating to before the erection of the storehouse in 1520–7. Nos. 1, 2a, 2b and 11 were dug out of a section without permission by Mr Peter de Rohan Willmer, after the excavation of 1970 had been completed. Their exact location is unknown but they appear to have been found in the filling of gully 9. Their finder allowed Miss Elizabeth Lewis, then of the Portsmouth City Museum, to see them for drawing and photography but was not prepared to deposit them in the museum (Elizabeth Lewis, *in lit.*, 3.ii.1971).

OBJECTS OF IRON

(figs. 104–109)

BY DAVID A. HINTON

12. (Pl. XLIII*b*). Iron barrel padlock; cf. *LMMC*, 146. (915). Trench 85, layer 5.
13. Prick-spur. Terminals missing. Point as *LMMC* type 8. Thirteenth- to fourteenth-century. (2184). Trench 103, layer 7.
14. Prick-spur. Terminals missing. Curved arms. *LMMC* type 8. Thirteenth- to fourteenth-century. (1309). Pit 132, layer 32.
15. Prick-spur. Probably as no. 13. (803). Trench 80, layer 5.
16. Prick-spur. Terminals as *LMMC* type C, having one (presumably the upper) side shaped and rounded. Long straight arms with unusual central bosses. Point as *LMMC* type 3, slender variant. Eleventh- to twelfth-century. (989). Trench 87, layer 5.
17. Rowel-spur. Probably as no. 19 below but terminals missing. (485). Gully 9 (trench 73, layer 11).
18. Rowel-spur. Broken; one terminal of *LMMC* type D. Short shank. Late thirteenth- or fourteenth-century. (1814). Trench 98, layer 14.
19. Rowel-spur. The rowel missing. Terminals *LMMC* types D and E. Long, slightly curved arms, long shank. Terminals suggest a fourteenth-century date (*LMMC* 105). (461). Gully 9 (trench 73, layer 7).

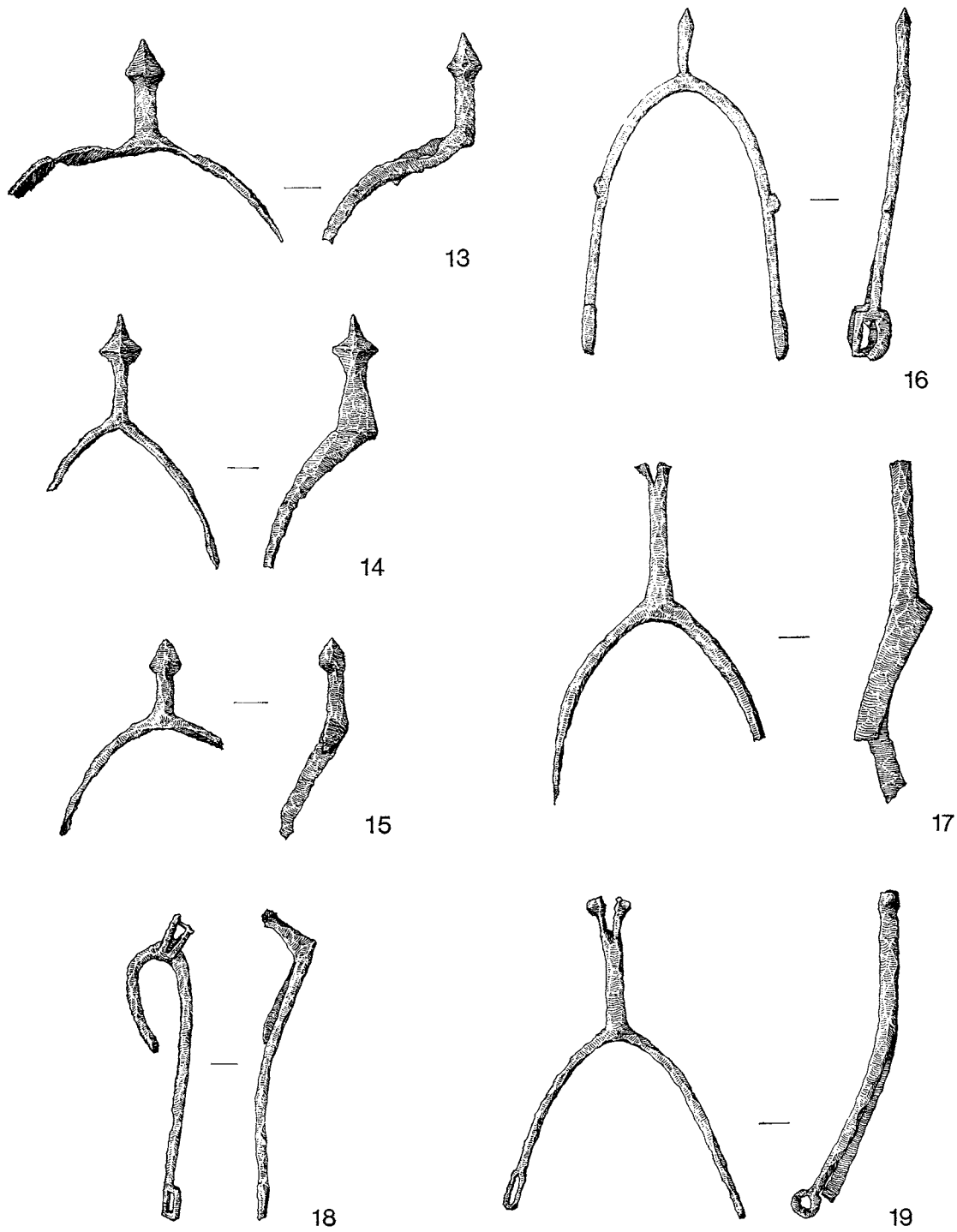

FIG. 104. Iron spurs (p. 196). Scale $\frac{1}{3}$

20. ? Arrow head.
(152). Trench 62, layer 8.
21. Arrow head. As *LMMC* type 2. Early medieval.
(723). Trench 79, layer 4.
22. Barbed arrow head. As *LMMC* type 13. Thirteenth-century or later.
(248). Trench 69, layer 3.
23. Arrow head. As *LMMC* type 1. Early medieval.
(1283). Trench 90, layer 26.
24. Bolt or dart. Post-medieval.
(973). Trench 87, layer 5.
25. Bolt with squared head. Possibly Roman.
(486a). Gully 9 (trench 73, layer 11).
26. Cross-bow bolt. As *LMMC* type 9. Thirteenth-century or later.
(1844). Trench 98, layer 10.
27. Cross-bow bolt.
(1876). Trench 99, layer 20.
28. Cross-bow bolt.
(391). Trench 72, layer 5.
29. Heavy barbed and socketed arrow or spear head.
(486b). Gully 9 (trench 73, layer 11).
30. Heavy barbed and socketed arrow head. As *LMMC* type 13; thirteenth-century.
(459). Gully 9 (trench 73, layer 7).
31. Flat, pointed blade with tang. Perhaps a medieval arrow head. As *LMMC* type 19.
(1631). Trench 95, layer 20.
32. Horseshoe. Very corroded. Possibly wavy-edged in which case twelfth- to thirteenth-century.
(180). Pit 44, layer 16.
33. Horseshoe. Wavy-edged. Twelfth- or thirteenth-century.
(2610). Trench 109, layer 10.
34. Horseshoe fragment with fiddle-key nail.
(287). Pit 57, layer 9.
35. Horse or ox shoe. Corroded with fiddle-key nails.
(1822). Gully 9 (trench 98, layer 15).
36. Horse or ox shoe. Corroded.
(1827). Gully 9 (trench 98, layer 15).
37. Horseshoe fragment.
(1320). Pit 132, layer 58.

In addition to the ox and horse shoes illustrated here fragments of six others have been found from general medieval layers; (415) trench 71, layer 6; (1170) trench 99, layer 6; (1812) trench 97, layer 11; (1843) trench 98, layer 17; (1846) trench 98, layer 10; (1888) trench 99, layer 15.

38. Shears with the tops of the blades nicked. As *LMMC* type III.
(1317). Pit 132, layer 58.
39. Oval frame with swivel. Probably a later medieval or sixteenth-century purse frame. As *LMMC* type C.
(710). Gully 9 (trench 75, layer 7).
40. Pintle for a strap hinge.
(2242). Trench 100, layer 75.

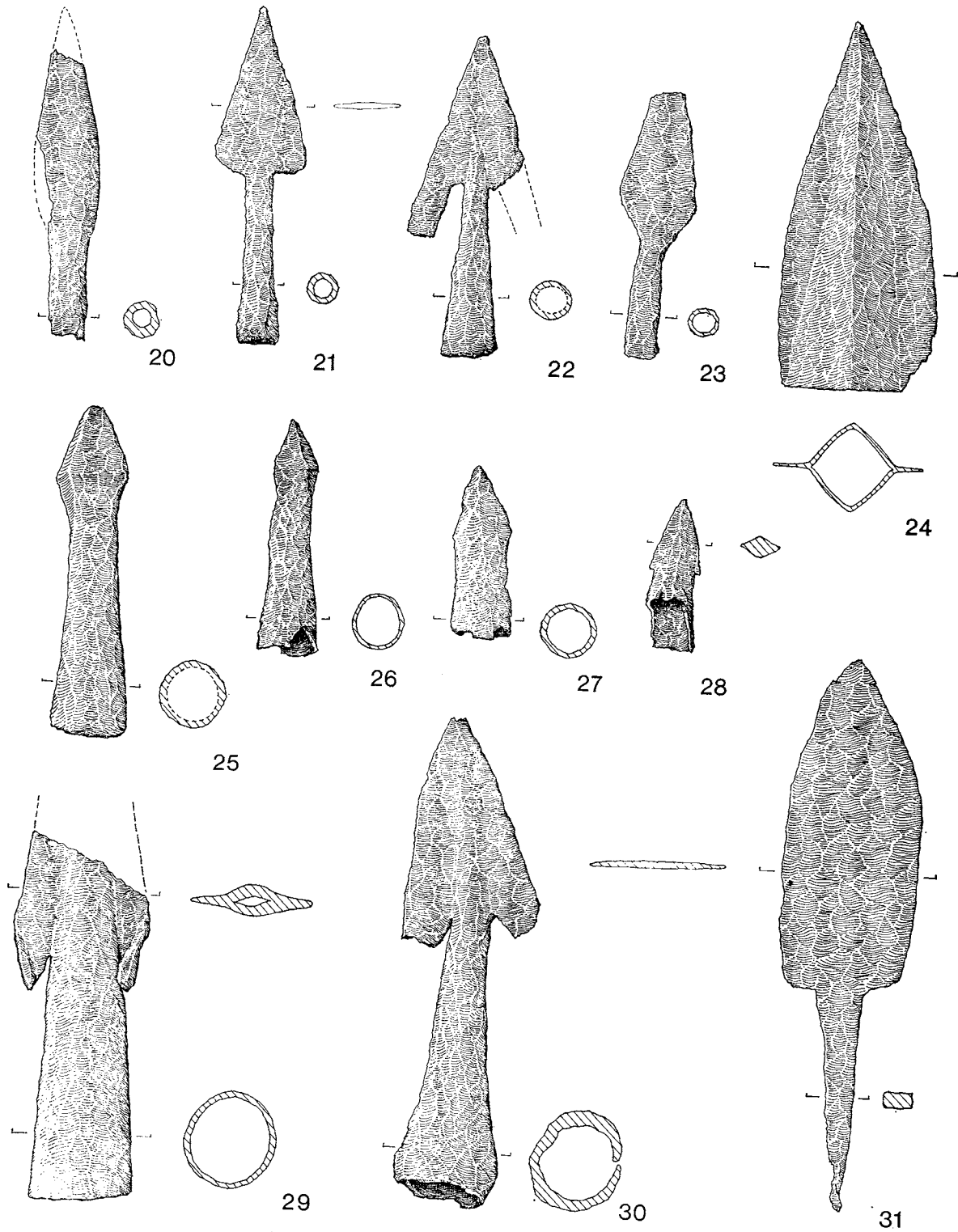

FIG. 105. Iron weapons (p. 198). Scale $\frac{1}{3}$

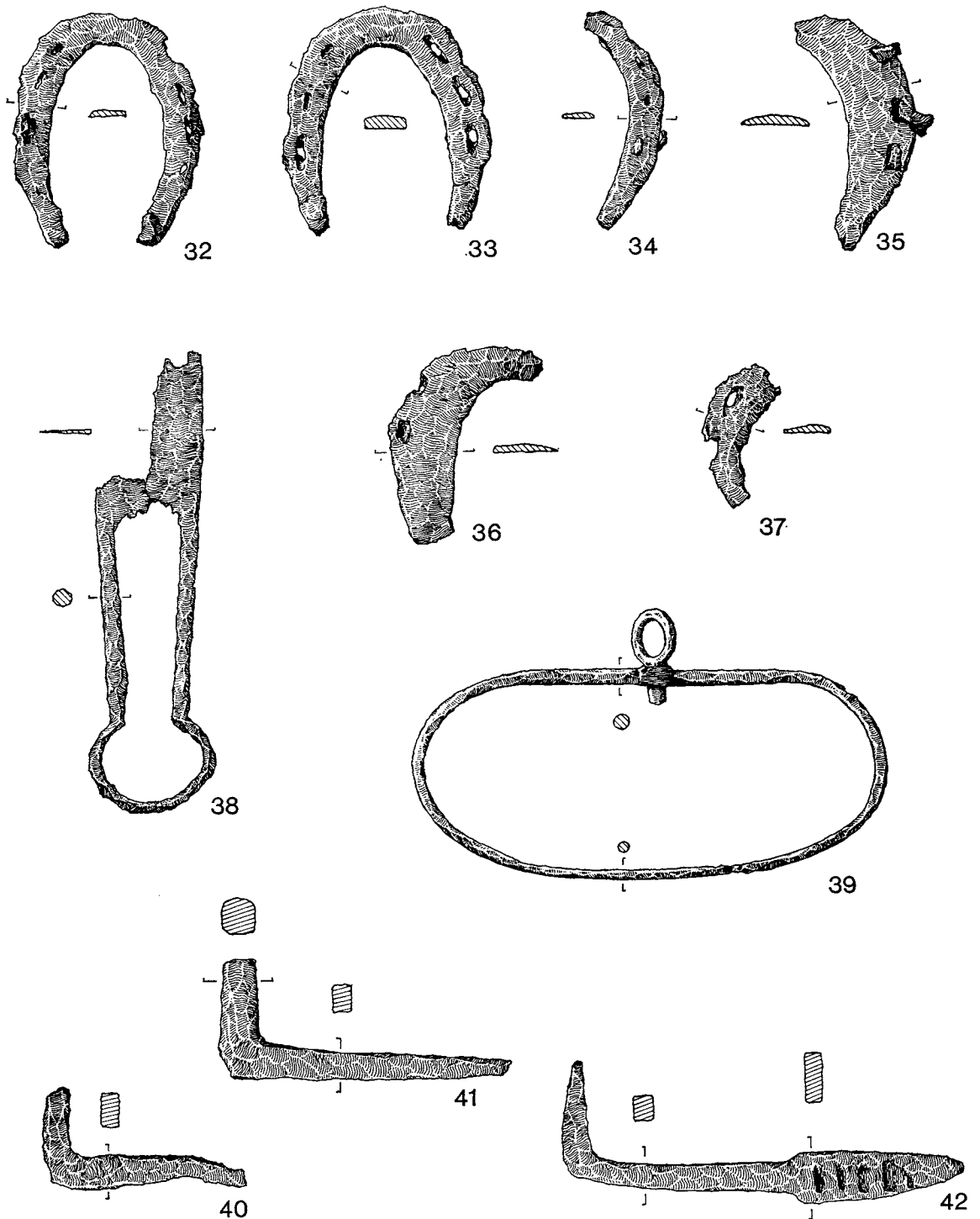

FIG. 106. Iron objects (pp. 198-201). Scale $\frac{1}{3}$

41. Pintle for a strap hinge.
(447). Trench 73, layer 6.
42. Hook with spike. Possibly for driving into the sea-bank to tie boats to.
(2162). Trench 101, layer 9.
43. Curved-back knife with rectangular strip-tang.
(19). Pit 11.
44. Knife. Triangular-sectioned with a strip-tang.
(1318). Pit 132, layer 58.
45. Knife blade.
(763). Pit 99, layer 34.
46. Knife blade.
(2193). Pit 197, layer 52.
47. Knife blade with groove below top edge. As *LMMC* pl. xi, 5. Early medieval.
(1114). Trench 89, layer 8.

A further seven knives were recovered from general medieval layers: (366) trench 72, layer 6; (511) trench 73, layer 10; (988) trench 87, layer 7; (1232) trench 90, layer 38; (1281) trench 91, unstratified; (1712) trench 96, layer 18; (2267) trench 101, layer 31.

48. Key. Round bow, open bit. As *LMMC* type III.
(2050). Trench 100, layer 25.
49. Key. Bow missing. As *LMMC* type VII B.
(608). Trench 74, layer 4.
50. Key. Solid bit.
(2095). Trench 100, layer 47.
51. Key. Highly corroded. Solid shank: ward as *LMMC* type IV. Kidney-shaped bow.
(462). Gully 9 (trench 73, layer 7).
52. Buckle. Plain with single loop and pin. As *LMMC* pl. lxxxix, no. 4. Its large size perhaps indicates a harness-buckle.
(2102). Gully 16 (trench 100, layer 61).
53. Single-loop buckle.
(1607). Trench 95, layer 61.
54. Single-loop buckle.
(1123). Trench 89, layer 4.
55. Single buckle with plate. Pin missing.
(1810). Gully 9 (trench 98, layer 15).
56. ?Pivoting latch hook.
(2103). Gully 16 (trench 100, layer 62).
57. Figure-of-eight chain-link or gate-fastener.
(1552). Trench 94, layer 25.
58. Tapered strip with terminal. Possibly a door fitting.
(2401). Pit 215, layer 27.
59. Twisted iron rod with beaten triangular head. Possibly a bucket handle. Since twisting is not usual on medieval work it may be Roman.
(239). Pit 57, layer 9.
60. Bar with neatly finished scroll hook ends.
(1059). Trench 88, layer 11.
61. Possibly a hook or hinge-pivot with tapered shaft, but too broken for certain identification.
(532). Gully 9 (trench 73, layer 11).

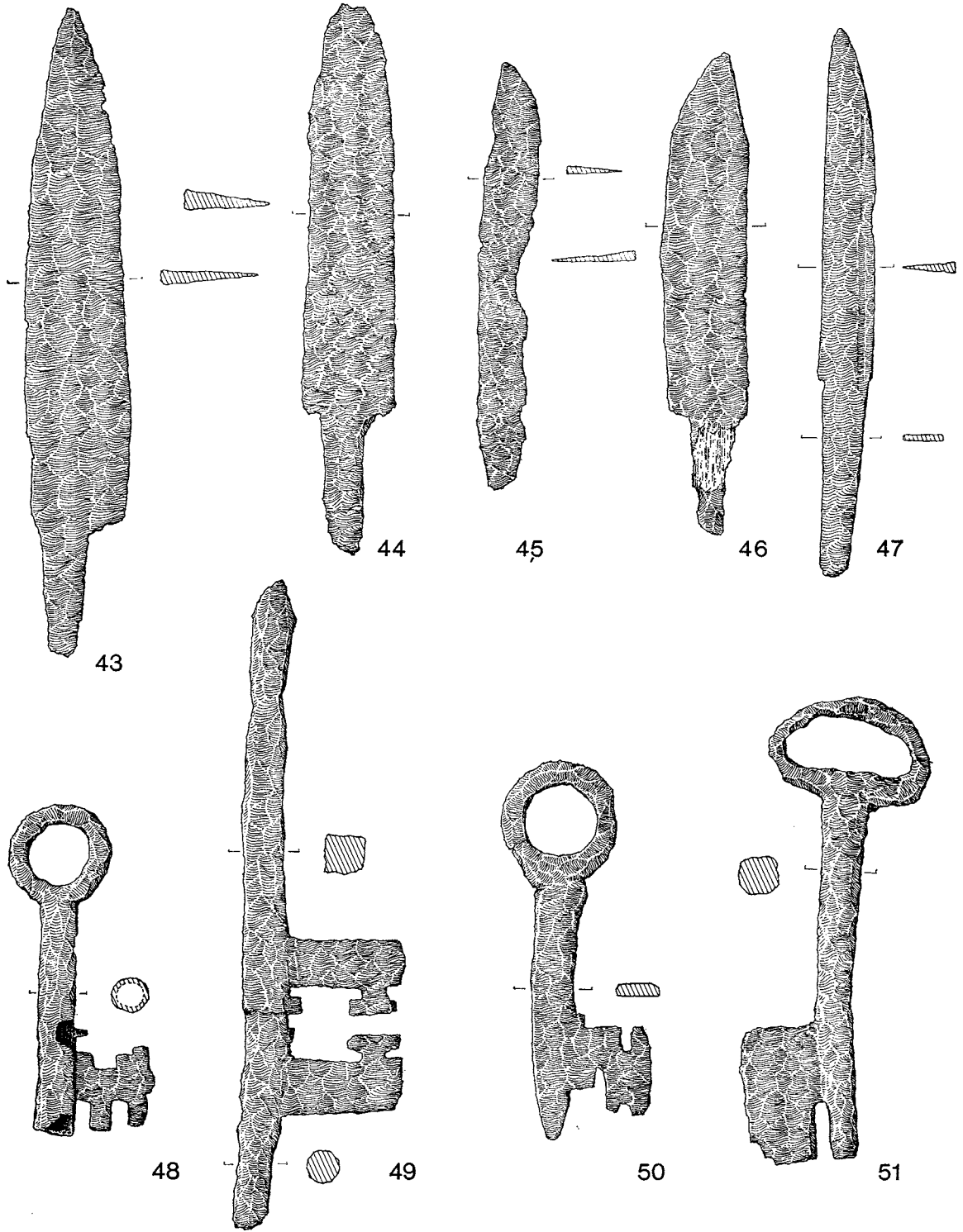

FIG. 107. Iron objects (p. 201). Scale $\frac{1}{2}$

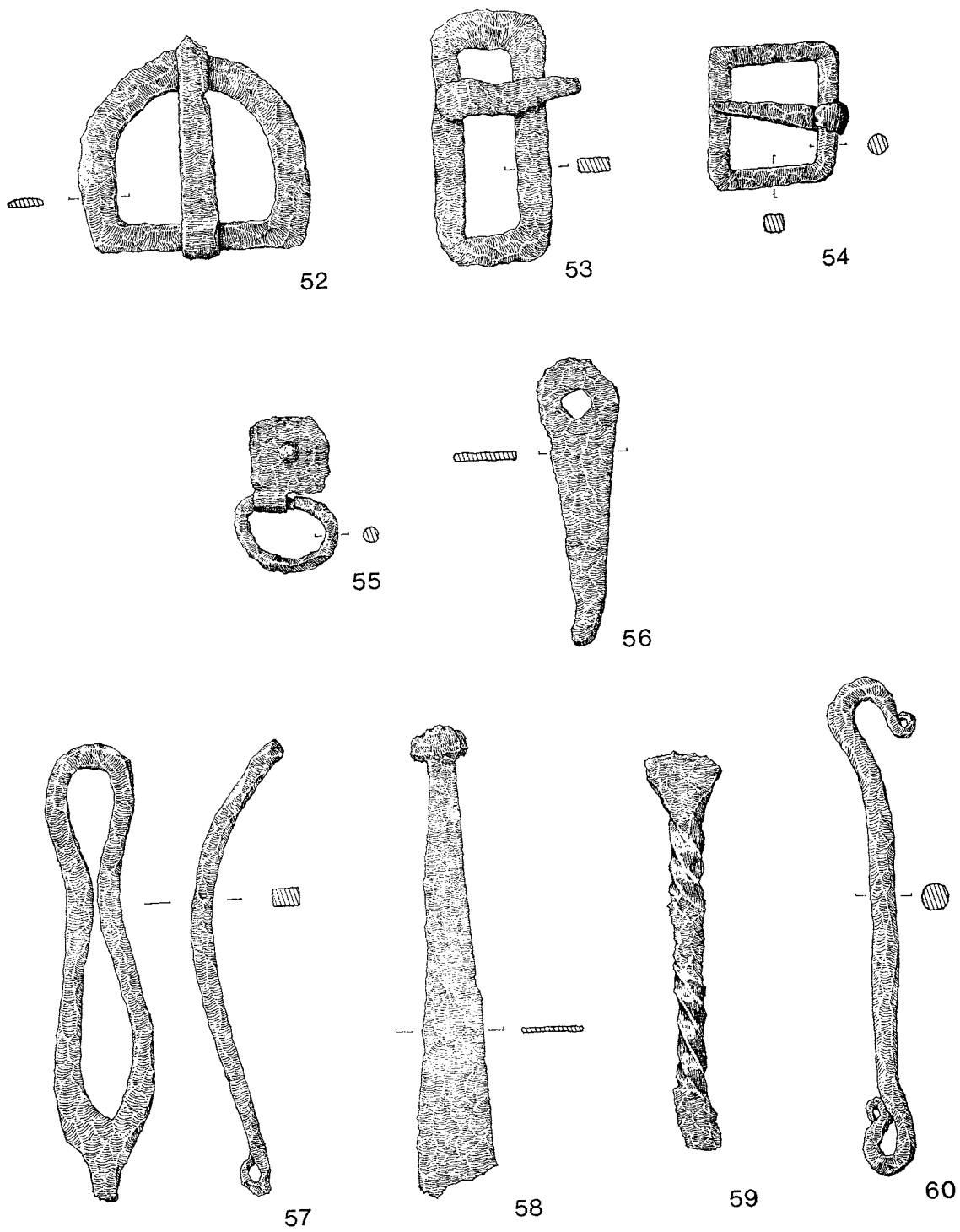

FIG. 108. Iron objects (p. 201). Scale $\frac{1}{3}$

62. Hook or a cupboard door hinge pivot.
(500). Gully 9 (trench 73, layer 11).
63. Possibly a key.
(463). Gully 9 (trench 73, layer 7).
64. Point, with attachment shaft.
(1939). Pit 189, layer 45.
65. Point, the other end perhaps a shaft to fit into a wooden handle.
(493). Gully 9 (trench 73, layer 11).
66. Unwelded chain-link ring.
(790). Pit 99, layer 46.
67. Unwelded (?) chain-link ring.
(293). Pit 57, layer 26.
68. Iron strip with nail for attachment.
(655). Gully 9 (trench 75, layer 7).
69. Perhaps a corroded and broken pruning-hook. Cf. Robinson (1973), p. 102, no. 8.
(2428). Pit 214, layer 23.
70. Three figure-of-eight chain-links and hook.
(1179). Pit 132, layer 59.
71. Rod.
(515). Gully 9 (trench 73, layer 11).

OBJECTS OF NON-FERROUS METAL

(fig. 110, pl. XLIIIc)

BY DAVID A. HINTON

72. ?Decorative casket-mount, probably gilt-bronze. Cf. *Portchester*, Vol. II, nos. 62-3, where a Saxon date was indicated by the context. A twelfth- to thirteenth-century date is more usual (Jope and Threlfall, 1959, pp. 267-8).
(1579). Trench 95, layer 31.
73. Bronze strip with attachment rivets.
(1801). Trench 97, layer 23.
74. Part of a decorative plate.
(1522). Trench 94, layer 5.
75. Casket hinge or buckle plate, cf. no. 77
(690). Trench 78, layer 5.
76. Single-loop buckle.
(1806). Trench 98, layer 10.
77. Single-loop buckle with hinged plate.
(40). Trench 37, layer 3.
78. ?Awl.
(2252). Trench 103, layer 9.
79. Casket key — possibly Roman.
(119). Gully 4 (trench 60, layer 14).
80. Bronze binding, heavy scalloped terminals each pierced by a single rivet.
(1748). Gully 16 (trench 96, layer 44).

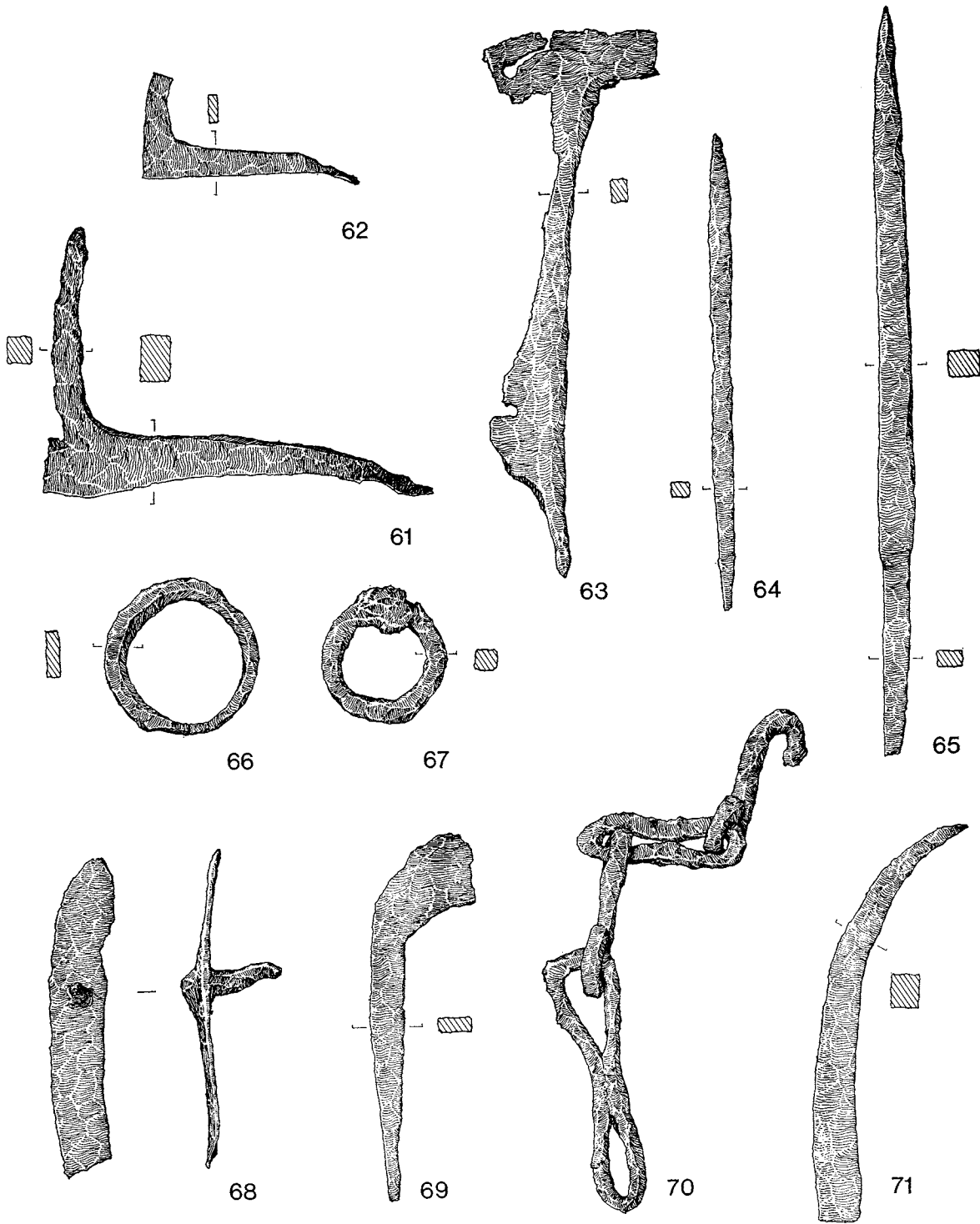

FIG. 109. Iron objects (pp. 201, 204). Scale $\frac{1}{2}$

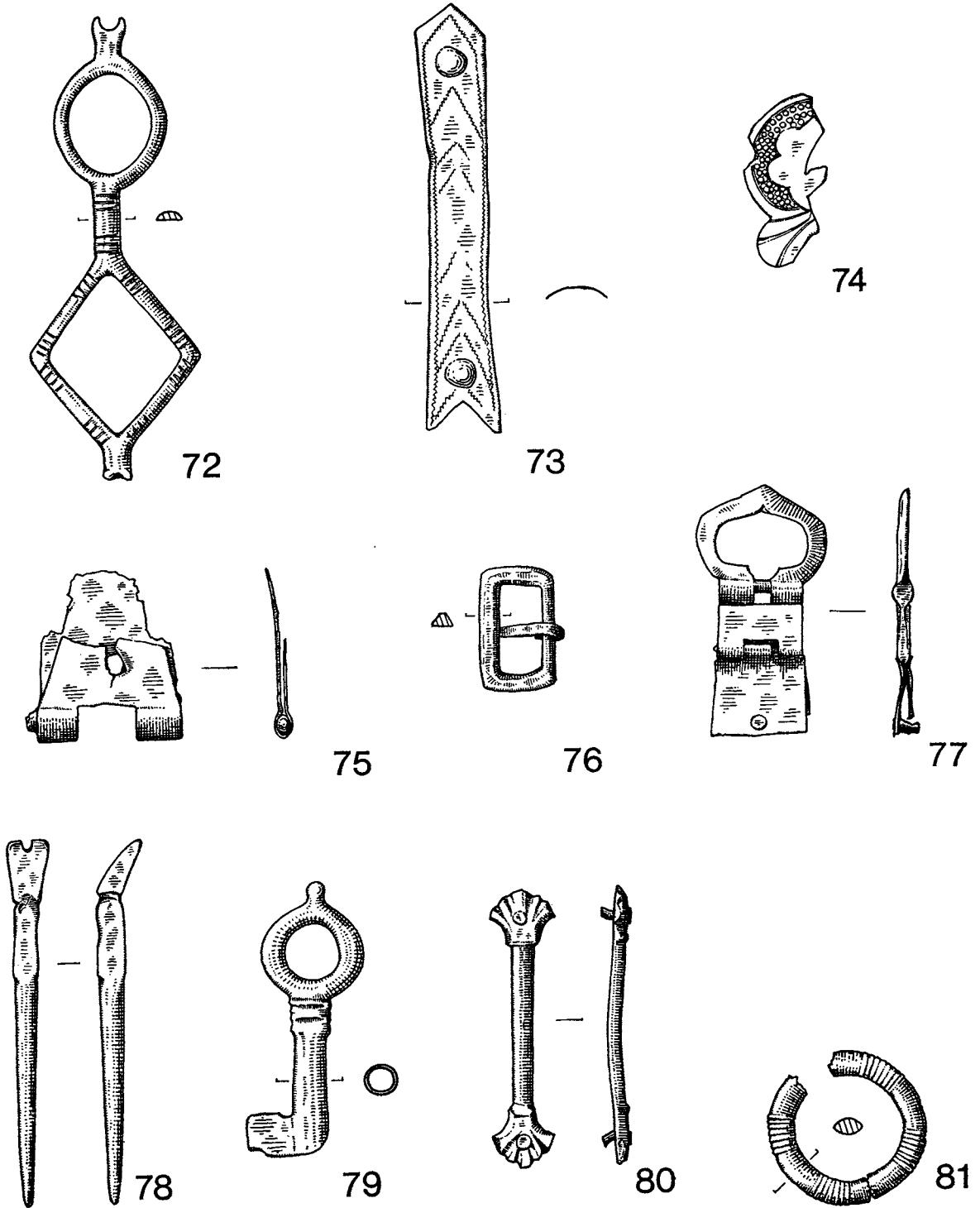

FIG. 110. Objects of non-ferrous metal (pp. 204, 207) Scale $\frac{1}{2}$

81. Loop, possibly a brooch or buckle.
(120). Gully 4 (trench 60, layer 14).
82. (pl. XLIIIc). Lead ampulla, one side cast as a scallop shell, the other bearing a crowned W. The latter denotes the shrine of Our Lady of Walsingham (Spencer, 1968, p. 140). The former, the scallop shell of St. James, is not an attribute necessarily particular to any one shrine, having become 'the emblem of pilgrimage itself' (*ibid.* p. 143). It belongs to Spencer's second group (Spencer, 1971, p. 60), and may have become a Walsingham characteristic because the shrine was near the sea (*ibid.*, p. 64).
Priory site, unstratified.

OBJECTS OF BONE

(fig. 111)

BY DAVID A. HINTON

83. Bone gaming counter with ring-and-dot motif. Probably twelfth- to thirteenth-century; such counters with variations of the ornament motif are not uncommon, e.g. Robinson (1973), p. 106, no. 25.
(281). Pit 57, layer 26.
84. Bone ring, probably a ferrule.
(1929). Trench 99, layer 38.

OBJECTS OF STONE

(figs. 111-12)

BY DAVID A. HINTON with identifications by DAVID PEACOCK

85. Spindle whorl of Kimmeridge shale. All these are probably Roman, as there seems to be little evidence of significant medieval exploitation of the shale beds.
(1259). Trench 90, layer 26.
86. Spindle whorl of Kimmeridge shale.
(1986). Unstratified.
87. Spindle whorl of Kimmeridge shale.
(1714). Trench 96, layer 14.
88. Whetstone. Grey indurated quartzite.
(2194). Pit 197, layer 52.
89. Whetstone. Quartz-mica-schist.
(18). Pit 11.
90. Whetstone. Quartz-mica-schist.
(1176). Trench 90, layer 22.
91. Whetstone. Grey sanky limestone possibly from Hythe beds of Kent. Roman stray?
(2600). Trench 109, layer 9.
92. Whetstone. Indurated grey metamorphosed siltstone.
(114). Trench 90, layer 6.

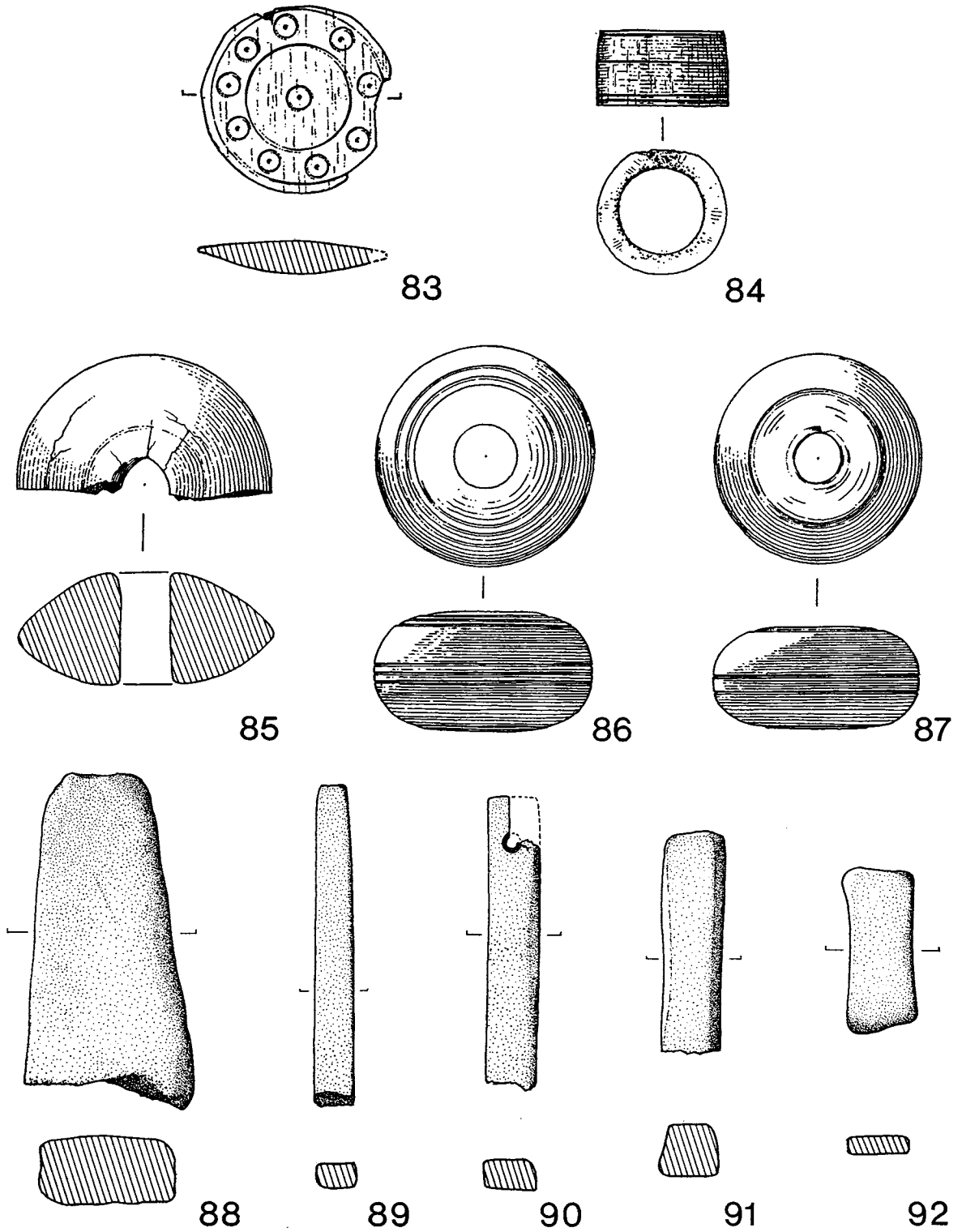
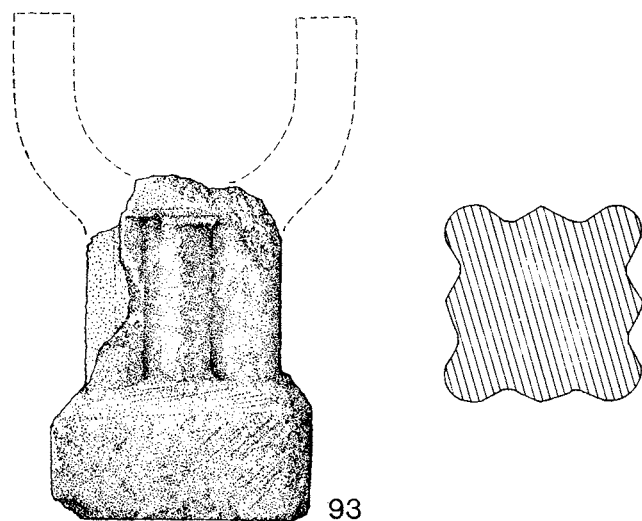
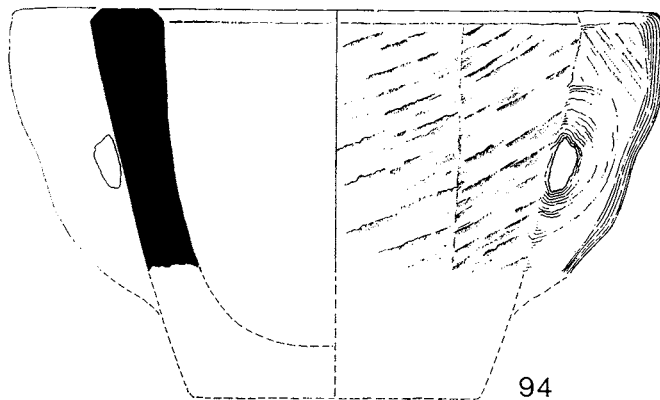

FIG. 111. Objects of bone and stone (p. 207). Scale $\frac{1}{4}$



93



94

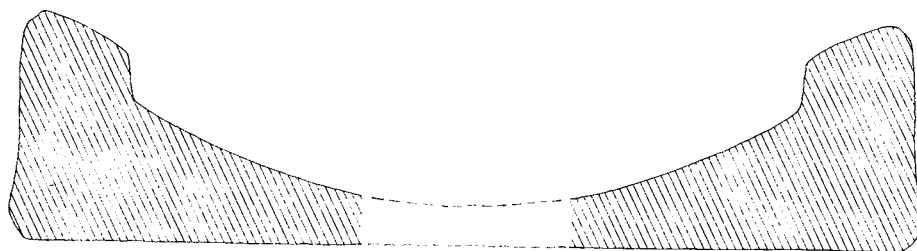

95

FIG. 112. Objects of stone (p. 210). Scale $\frac{1}{3}$

93. Limestone cresset.
(744). Pit 100, layer 6.
94. Purbeck marble mortar. Thirteenth- to fourteenth-century. Dunning's type 2, in Hurst (1961), pp. 279–84. Dunning notes that a pierced handle is relatively uncommon in stone mortars, especially Purbeck ones, because the stone splits.
(1799). Trench 97, layer 11.
95. Mortar of coarse gritstone, possibly millstone grit.
(818). Trench 76, layer 6.

GLASS

BY D. B. HARDEN

The only significant item of glass from a medieval context came from gully 9, along with pottery and other finds of types which indicate that the gully was disused and filled in at some date during the early sixteenth century — the very end of the medieval period.

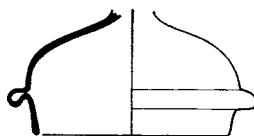

FIG. 113. Glass lid (pp. 201–11). Scale $\frac{1}{3}$

Description (fig. 113)

Three fragments (two of which join) from rim and shoulder of a lid, dullish dark green, verging on emerald green; full of tiny bubbles, but clear and without any weathering except for some iridescent sheen on under surface. Plain, straight rim with flame-rounded lip, above which an outward fold forms a flange to support the lid on the lip of a vessel; above this is a low, curved shoulder sloping upward slightly as it moves inward towards the bottom of a knobbed finial, whose exact shape must remain uncertain. Diam., flange 6.6 cm.; diam., lip 5.1 cm.; ht., to bottom of finial 3 cm.

*Discussion*¹

Knobbed lids of this kind with flanges above straight rims — a very obvious and natural form of lid — occasionally occur in Roman glass, but thereafter seem not to have been used before the sixteenth century. From about 1530–40 onward, they become increasingly common on many kinds of glass goblets made at Venice or in the Venetian style elsewhere.²

¹ In identifying this piece I have benefited greatly from the ready help and advice of Mr Hugh Tait, F.S.A. He must not, however, be held responsible for any errors of fact or of interpretation that may have crept in to this discussion.

² For Venetian and *façon de Venise* examples see, e.g. Honey, 1946, pl. 25, A (sixteenth century); Gasparetto, 1958, pls. 45 (c. 1500), 59, 65–7 (sixteenth century), 78 (1565–72), 81–2 (second half of sixteenth century); *Art in*

Glass: a Guide to the Glass Collections, Toledo Museum of Art (1969), figs. on p. 50 (French, *façon de Venise*, first half of sixteenth century) and p. 51 (German, *façon de Venise*, 1600–20); and *Glass from the Corning Museum of Glass: a Guide to the Collections* (1974), pp. 40–2, nos. 43 (Venetian, sixteenth century), 44 (South German, *façon de Venise*, dated 1617) and 45 (Austrian, *façon de Venise*, c. 1580), and p. 52, no. 59 (German, before 1574).

These, whether from Venice or some other centre, are mainly of colourless glass, plain or decorated with enamelling, gilding or engraving. There is, however, at least one dark green piece, somewhat similar in colour to ours, a covered goblet in the Victoria and Albert Museum made at Hall-in-the-Tyrol of *façon de Venise* diamond-engraved glass of the second half of the sixteenth century (Honey, 1946, pl. 33D; Gasparetto, 1958, pl. 85). The dark green glass of this piece and of ours is quite unlike the dark green of late medieval fifteenth-century forest glass, and we must look upon them rather as dark green soda glasses in the Venetian style. If so, the discovery of our piece in a gully that was filled in during the early sixteenth century means that it was fairly certainly an import, since there is no evidence that *façon de Venise* glasses were made in England until the middle of that century at earliest (Harden, 1972, 107).

COINS

Altogether, nine coins and counters were recovered during the excavation, none coming from a tightly stratified position. The coins were identified by the Coin Room of the Ashmolean Museum. Mr F. Elmore Jones kindly provided detailed notes upon which the discussion of no. 1 is based.

1. Silver penny of Stephen (1135-54). Irregular issue of Type I (Mack no. 207B.) ? Canterbury (Sansou).
(795). Trench 80, layer 5.
2. Half of a silver penny probably of Stephen (1135-54). Type I.
(925). Trench 85, layer 8.
3. Silver penny of Henry III (1247-60). Class III: London.
(869). Trench 82, layer 9.
4. Silver penny of Edward I (1279). Fox class Id.
(1723). Trench 96, layer 21.
5. Bronze counter imitating a 'crochards' current 1295-1300. English.
(730). Trench 79, layer 4.
6. Silver penny of Edward IV (1465-76). York archiepiscopal mint: Archbishop George Neville. G and K, e.g. by bust.
(1773). Trench 98, layer 6.
7. Fragments of silver coin: unidentified.
(1833). Trench 98, layer 19.
8. Nuremburg counter: c. 1580.
(1818). Trench 98, layer 14.
9. Nuremburg counter: sixteenth-century.
(684). Trench 78, layer 4.

No. 1 is the only coin worthy of comment. Mr Elmore Jones reports that it is a very rare 'ANT' coin of Stephen of the kind which shows the novel feature of large annulets just within the collar band. It is a variety of Stephen Type I (B.M.C. 240-3). No die link exists with the British Museum specimens but Mack (1966, pl. vi) illustrates five examples of which three are not in the British Museum collection. The Portchester coin is a die duplicate of his no. 207B, which comes from the Linton find (Lockett Sale, 6th May 1955, lot 1158).

The legend reads: + [SĀ]N[SON : ON Ā]NT. The moneyer, Sanson, is thought to have worked at Canterbury. The origin and date of these coins has been discussed elsewhere (Elmore Jones, 1958) where it has been shown that the Sanson-‘ANT’ coins should be associated with the early Henry II ‘Tealby’ type coins of the moneyer Sansun which can probably be attributed to Canterbury.

Most of the specimens are very light in weight, which points to organized forgery on a large scale. The Portchester example conforms to this pattern, weighing only 14.1 grains.

BIBLIOGRAPHY

- ELMORE JONES, F. 1958. ‘Stephen Type VII.’ *B.N.J.* xxviii, 537–54.
 GASPARETTO, A. 1958. *Il Vetro di Murano dalle Origini ad Oggi* (Venice).
 HARDEN, D. B. 1972. ‘Ancient Glass III: Post-Roman.’ *Arch. J.* cxxviii, 78–117.
 HONEY, W. B. 1946. *Glass: a Handbook* (Victoria and Albert Museum, London).
 HURST, J. G. 1961. ‘The Kitchen Area of Northolt Manor, Middlesex.’ *Med. Arch.* v, 211–90.
 JOPE, E. M. and THRELFALL, R. I. 1959. ‘The Twelfth-century Castle at Ascot Doilly, Oxfordshire.’ *Antiq. J.* xxxix, 219–73.
 LMMC. *Medieval Catalogue*. London Museum Catalogues, no. 7 (London, 1940).
 MACK, R. P. 1966. ‘Stephen and the Anarchy, 1135–1154.’ *B.N.J.* xxxv, 38–112.
 NOBLE, D. 1970. ‘Coldingham Excavation IV.’ *Proc. Berwickshire Naturalists’ Club*, xxxviii, part ii.
 ROBINSON, M. *et al.* 1973. ‘Excavations at Copt Hay, Tetsworth: M.40 site 4.’ *Oxon.* xxxviii, 41–116.
 SPENCER, B. W. 1968. ‘Medieval Pilgrim Badges.’ In Renaud, J. G. N. *Rotterdam Papers* (Rotterdam), pp. 137–46.
 SPENCER, B. W. 1971. ‘A Scallop-shell Ampulla from Caistor and Comparable Pilgrim Souvenirs.’ *Lincs. Hist. and Arch.* vi (1971), 59–66.
 THORDEMAN, B. 1939. *Armour from the Battle of Wisby, 1361*, Vol. ii (Stockholm).

VIII. THE ANIMAL BONES

MAMMALS

BY ANNIE GRANT

IN all, 6998 animal bone fragments recovered during the excavation of the medieval layers of the site were submitted to the author for identification. Of these, 2443 were not positively identified. The 4555 bones that were identified form the basis of this report.

The bones were recovered from pits and gullies covering 550 years of the site's occupation and so have been divided into several groups which are shown with their approximate dates in Table I.

TABLE I

<i>Group</i>	<i>Context</i>	<i>Date</i>
1. Saxo-Norman	Pits	A.D. 1000-1100
2. Early medieval tradition	Pits	A.D. 1100-1200
3. Developed medieval tradition	Pits and gullies	A.D. 1200-1300
4. Late medieval tradition	Gullies	A.D. 1300-1400
6. Painted ware tradition	Gullies	A.D. 1470-1570

(No bones were identified from the ultimate medieval group 5.)

The possible sources of error and bias that may affect an unsieved site such as this have already been discussed in the report on the Roman animal bones from the site (Grant, 1975a). Such biases as exist may be compounded by the relatively small size of the medieval sample.

The Animals Represented

Identification of the bones revealed the presence of the following species: cattle, sheep and/or goats, pigs, birds, red deer, roe deer, fallow deer, horses, dogs, cats, fish, mice, rabbits and/or hares, and a small carnivore. Three methods have been used to calculate the percentages of species represented. Full details of these methods are given in the report on the Roman bones from Portchester (Grant, 1975a). Briefly, the methods used are 'epiphyses only', where bone fragments with part of an epiphysis or fusion surface and mandibles with at least one tooth present are counted; 'total fragments', where all bone fragments except rib and skull fragments are counted; and 'minimum number of individuals' which are calculated by dividing by two the number of the best represented bone for each animal in each group. This last method was used only for the best represented animals, and birds, which are the subject of a separate report (pp. 233-9), were also excluded. The results are given in Table II and in histogram form in fig. 114. Bones dated to group 3 were recovered

EXCAVATIONS AT PORTCHESTER CASTLE

from both pits and gullies, and separate results have been given for the two different contexts to discover if there were any differences in disposal or preservation.

Because of the sample size, especially in groups 1 and 4, differences between species and groups are not necessarily statistically significant. However, some of the changes may well be significant and are worth noting. The bones of cattle are the most numerous of all bones

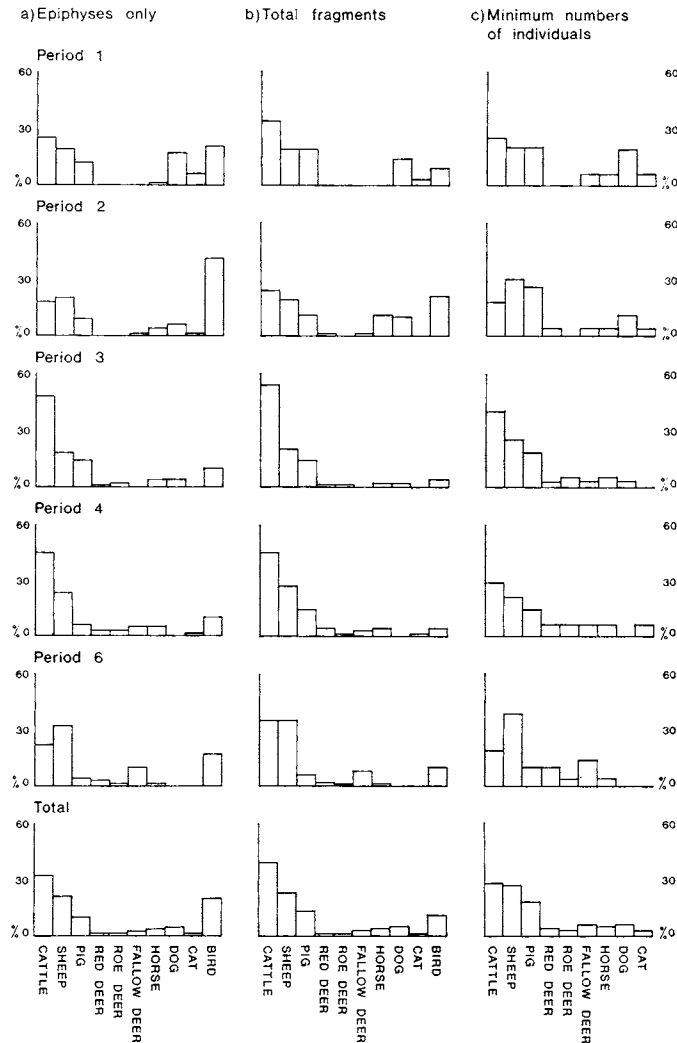

FIG. 114. Histogram of animals represented

recovered from the Portchester medieval layers. They are most important in groups 3 and 4 and least important in groups 2 and 6, where they are outnumbered by sheep bones. Sheep bones are the next most frequently occurring bones, and are most important in groups 2 and 6. They are fairly evenly represented in the other three groups and form around 20% of the bones identified, though slightly more in group 4. Pig bones decline fairly steadily in

TABLE II
Percentages of Species Represented

Period	1		2		3		3		3		4		6					
	No.	%	No.	%	Pits		Gullies		Total		No.	%	No.	%	Total		Saxon total	
					No.	%	No.	%	No.	%					No.	%	%	%
<i>a. Epiphyses only</i>																		
Cattle	50	24	95	18	134	34	203	63	337	47	53	46	70	23	605	32	2696	35
Sheep	39	19	106	20	92	23	37	11	129	18	26	23	99	32	399	21	1653	22
Pig	28	13	42	8	55	14	45	14	100	14	7	6	13	4	190	10	1083	14
Red deer	—	—	2	—	6	2	4	1	10	1	2	2	8	3	22	1	203	3
Roe deer	—	—	—	—	11	3	—	—	11	2	2	2	3	1	16	1	156	2
Fallow deer	1	—	5	1	1	—	—	—	1	—	4	3	31	10	42	2	12	—
Horse	2	1	24	4	9	2	9	3	18	3	5	4	4	1	53	3	82	1
Dog	36	17	39	7	5	1	13	4	18	3	—	—	—	—	93	5	35	—
Cat	12	6	3	1	—	—	—	—	—	—	1	1	—	—	16	1	58	1
Bird	41	20	220	41	66	17	6	2	72	10	11	10	54	17	398	21	1531	21
Fish	1	—	—	—	4	1	—	—	4	1	—	—	5	2	10	1	42	1
Mouse	—	—	—	—	2	1	—	—	2	—	—	—	—	—	2	1	—	—
Rabbit/hare	—	—	—	—	4	1	2	1	6	1	4	3	22	7	32	2	28	—
Small mammal	—	—	—	—	5	1	5	2	10	1	—	—	—	—	10	1	—	—
Total	210	—	536	—	394	—	324	—	718	—	115	—	309	—	1888	—	7629	—

b. Total Fragments

Cattle	136	34	192	23	256	41	391	67	647	54	116	45	171	34	1262	39	6746	45
Sheep	78	19	159	19	168	27	73	13	241	20	69	27	174	34	721	23	3567	24
Pig	77	19	88	11	100	16	71	12	171	14	35	14	32	6	403	13	2277	15
Red deer	1	—	9	1	9	1	4	1	13	1	7	3	8	2	38	1	392	3
Roe deer	—	—	—	—	13	2	—	—	13	1	3	1	4	1	20	1	234	2
Fallow deer	1	—	7	1	2	—	—	—	2	—	5	2	43	8	58	2	28	—
Horse	2	—	97	12	14	2	10	2	24	2	8	3	5	1	136	4	142	1
Dog	58	14	80	10	6	1	20	3	26	2	—	—	—	—	164	5	58	—
Cat	12	3	3	—	—	—	—	—	—	—	2	1	—	—	17	1	51	—
Bird	38	9	190	23	46	7	5	1	51	4	11	4	53	10	343	11	1407	9
Fish	1	—	—	—	4	1	—	—	4	—	—	—	5	1	10	—	42	—
Mouse	—	—	—	—	2	—	—	—	2	—	—	—	—	—	2	—	—	—
Rabbit/hare	—	—	—	—	3	—	1	—	4	—	3	1	14	3	21	1	33	—
Small mammal	—	—	—	—	3	—	5	1	8	—	—	—	—	—	8	—	—	—
Total	404	—	825	—	626	—	580	—	1206	—	259	—	509	—	3203	—	14977	—

c. Minimum numbers of individuals

Cattle	4	25	5	19	—	—	—	—	16	40	4	29	4	19	33	28	149	20
Sheep	3	19	8	30	—	—	—	—	10	25	3	21	8	38	32	27	269	37
Pig	3	19	7	26	—	—	—	—	7	18	2	14	2	10	21	18	249	34
Red deer	—	—	1	4	—	—	—	—	1	3	1	7	2	10	5	4	27	4
Roe deer	—	—	—	—	—	—	—	—	2	5	1	7	1	4	4	3	18	2
Fallow deer	1	6	1	4	—	—	—	—	1	3	1	7	3	14	7	6	not calc.	—
Horse	1	6	1	4	—	—	—	—	2	5	1	7	1	4	6	5	7	1
Dog	3	19	3	11	—	—	—	—	1	3	—	—	—	—	7	6	5	1
Cat	1	6	1	4	—	—	—	—	—	—	1	7	—	—	3	3	6	1
Total	16	—	27	—	—	—	—	—	40	—	14	—	21	—	118	—	730	—

importance from group 1 to group 6, although in group 3 they show a slight increase. The minimum numbers of individuals results give a slightly different picture, with more pigs than cattle in group 2. The decline in numbers in the later periods is seen using this method too.

Deer bones show a marked increase in numbers during the medieval period, from less than 1% of the total in period 1 to 14% in period 6. The increase in the numbers of fallow deer is especially notable — they form 10% of the total in group 6.

Horse bones are most common in groups 2, 3 and 4, although in no group do they form more than 4% of the total using the figures calculated by method (a). The method (b) results indicate 12% in group 2, but this high percentage is due to the presence of fragmented remains of one almost complete animal in a pit in this group.

The percentages of cat and dog bones are highest in group 1, where dog bones are almost equal in numbers to sheep, and more numerous than pig bones. However, no dog bones at all were found in groups 4 and 6, and no cat bones in groups 3 and 6. The dog and cat bones of groups 1 and 2 were almost all found together, in pit 110 in group 1, and in pit 29 in group 2. The bones of the other animals, with the exception of the horse bones in group 2, were generally well distributed in the various pits of each group.

Bird bones were found in fairly large numbers at the site, especially in group 2 where they form 41% (or 23%) of the total. They are also fairly common in groups 1 and 6 and least common in groups 3 and 4.

The other animals are only represented in fairly small numbers. This must at least in part be related to the very small size of their bones and the consequent small chance of their recovery. A smaller range of wild species was recovered from the medieval than from the Saxon layers (see Grant, 1976, p. 263), where bones from badgers, voles, foxes and frogs were identified. On commonsense grounds at least, the small number of fish bones should not accurately represent the true importance of fish to the economy of a site almost surrounded by water.

A comparison between the Saxon and medieval results shows a not dissimilar general picture. The most significant differences are the increased numbers of fallow deer, the slight increase in horse, and the larger numbers of dog bones in the medieval period. The percentages of the three main meat animals and of bird bones is very similar for the two periods. However a comparison of the minimum numbers of individual results of the two periods gives very different results, at least for cattle, sheep and pigs. In the Saxon period there were larger numbers of sheep and pigs than of cattle, whereas in the medieval period cattle were still the most numerous, although there were almost equal numbers of sheep. Pigs were definitely the least important of these three animals. The differences in the results obtained by the different methods of species calculations lie partly in the differences in the representation of particular parts of the skeleton. This is discussed in the next section. It emphasizes the dangers of the use of any kind of percentage calculation. Although some of the biases of each of the methods are understood, their effects cannot be confidently predicted and figures given using any of the methods should only be treated as a rough indication of the true picture.

The two separate analyses of the bones recovered from the pits and the gullies of period 3 reveal other potential dangers, as they show very different results. The main difference would

seem to be the smaller numbers of bones of comparatively small animals, notably sheep and birds, recovered from the gullies. If the bones that eventually were found in the gullies had been left around on the ground surface before they were thrown or cleared into the gullies they might have been more fragmented and eroded than bones that were put into the pits, which would have provided a more protected environment. This would bias the recovery in favour of larger and more robust bones in the gullies. It was in fact noted that the bones recovered from gullies were generally more eroded than bones recovered from pits. However, if better preservation of smaller bones was the sole reason for the larger numbers of sheep and bird bones from pits, it is surprising that the percentages of pig bones recovered from the two contexts were so similar. Pig bones are very vulnerable to decay and fragmentation, and would be expected to have suffered even more than sheep bones in an unprotected environment. The differences between the pits and gullies of group 3 may be relevant to an assessment of the differences between the early and late groups at the site, since the bones of groups 1 and 2 were exclusively from pits and the bones of groups 3 and 4 were almost exclusively from gullies.

In conclusion it should be noted that despite fluctuations in the precise percentages of cattle bones, in all groups they would have formed the bulk of the meat diet since a cow will provide approximately seven times the meat of a sheep and four times the meat of a pig.

Analysis of Bones Represented and Butchery

Table III gives an analysis of the individual bones recovered for cattle, sheep and pig. Unfortunately there were only relatively few bones in several of the medieval groups, and only group 3 provided a large enough sample for very meaningful comparisons to be made with the Saxon period bones. Percentages were calculated as percentages of the greatest number for each animal in each period, with adjustments made to compensate for variations in the numbers of individual bones in the complete skeleton. These percentages can be misleading in a very small sample as they overemphasize the differences in the representation of the bones. For this reason the histograms in fig. 115 have only been drawn for group 3 and the medieval total, and the Saxon total has been included for comparative purposes.

The analysis of the cattle bones is given in Table IIIa and fig. 115. The results are broadly similar for all groups and suggest that the main factors affecting the representation of the bones are recovery and survival (see Brain, 1969; Isaac, 1967; Grant, 1975a). The most significant difference between the medieval groups as a whole and the Saxon group is in the slightly lower proportion of skull bones, especially horn cores, in the medieval groups. This suggests that if there was a horn industry, it was not in the area excavated. The horns may have been removed from the majority of the animals for use elsewhere. In a late fourteenth-century pit at Petergate, York, nearly 200 horn cores were found; they were presumed to be the waste from a horner's workshop (Ryder, 1970).

Table IIIb and fig. 115 give the analyses of the sheep bones. Again the broad pattern shows the influence of survival and recovery on the representation of the animal bones. The comparison between the medieval and Saxon results does show some interesting differences. In the Saxon group the discrepancy between the numbers of mandibles and all other bones was very large. This was assumed to be due to the fact that mandibles have both a high sur-

TABLE III

Analysis of Bones Represented

Period	1		2		3		4		6		Total		Saxon total	
	No.	%	No.	%	No.	%	No.	%	No.	%	No.	%	No.	%
<i>a. Cattle</i>														
Horncore	3	43	4	44	7	23	2	29	—		16	30	197	71
Skull	11 (20)		4 (1)		24 (22)		— (2)		2 (1)		41 (46)		535 (541)	
Orbit	5	71	1	11	4	13	—		—		10	19	108	39
Upper jaw	—		2	22	13	42	—		—		15	28	176	64
Mandible	2	29	7	78	31	100	1	14	—		41	76	277	100
Scapula D	1	14	4	44	15	48	1	14	1	13	22	41	130	47
Humerus P	3	43	—		1	3	—		3	38	7	13	31	11
D	1	14	3	33	14	45	3	43	2	25	23	43	160	58
Radius P	3	43	9	100	23	74	3	43	1	13	39	72	154	56
D	—		2	22	19	61	—		1	13	23	43	68	25
Ulna P	2	29	5	56	16	52	—		1	13	24	44	110	40
Metacarpal P	7	100	7	78	23	74	7	100	7	88	51	94	202	73
D	3	43	4	44	18	58	3	43	2	25	30	56	86	31
1st phalange	2	14	5	22	20	16	7	29	7	25	41	20	182	18
2nd phalange	2	14	4	11	9	10	4	14	3	13	22	11	61	6
3rd phalange	2	14	1	11	5	6	2	14	—		10	6	26	3
Pelvis with acetabulum	4	57	5	56	18	58	3	43	3	38	33	61	192	69
Femur P	—		2	22	5	16	1	14	3	38	11	20	109	39
D	2	29	1	11	8	26	2	29	2	25	15	28	81	29
Tibia P	—		4	44	8	26	1	14	1	13	14	26	76	27
D	1	14	8	89	20	65	1	14	2	25	32	59	166	60
Calcaneum	3	43	4	44	13	42	6	86	7	88	33	61	116	42
Astragalus	—		5	56	12	39	1	14	6	75	24	44	128	46
Metatarsal P	6	86	5	56	30	97	5	71	8	100	54	100	189	68
D	3	43	3	33	25	81	1	14	8	100	40	74	96	35
Atlas	—		—		4	26	1	29	1	25	6	22	34	25
Axis	—		—		4	26	1	29	—		5	19	34	25
Cervical vert.	3		2		18		1		12		36		105	
Thoracic vert.	1		4		20		3		3		31		147	
Lumbar vert.	1		3		3		2		—		9		73	
Sacrum	—		—		2		1		—		3		12	
Caudal vert.	3		—		1		8		—		4		5	
Vert. frag.	13		4		35		8		14		74		329	
Upper teeth	6		16		37		6		6		71		432	
Lower teeth	20		11		50		16		16		113		516	

vival potential and, because of their fairly conspicuous appearance, a high recovery potential. Another possible conclusion was that the large numbers of mandibles recovered indicated the presence of butchery waste. There was no other evidence to support this view, however, as other 'waste' bones, for example metapodia and other skull bones, were not particularly well represented. The analysis of the Roman bones (Grant, 1975a) showed a similar if slightly

TABLE III—*continued*

Period	1		2		3		4		6		Total		Saxon total	
	No.	%	No.	%	No.	%	No.	%	No.	%	No.	%	No.	%
<i>b. Sheep</i>														
Horn core	—		2	13	6	30	2	40	4	25	14	30	103	19
Skull	2		3		3		1		1		10		46	
	(1)		(1)		(4)		(3)		(1)		(10)		(74)	
Orbit	—		2	13	2	10	—		—		4	9	22	4
Upper jaw	1	17	2	13	5	25	—		—		8	17	88	16
Mandible	6	100	6	46	20	100	2	40	10	63	43	93	536	100
Scapula D	3	50	6	46	14	70	1	20	7	44	31	67	83	15
Humerus P	—		3	20	6	30	1	20	4	25	14	30	36	7
D	2	33	9	60	15	75	4	80	16	100	46	100	111	21
Radius P	3	50	15	100	11	55	2	40	9	56	40	87	100	19
D	1	17	12	80	3	15	—		7	44	23	50	45	8
Ulna P	—		5	33	3	15	—		8	50	16	35	31	6
Metacarpal P	3	50	6	46	5	25	5	100	4	25	23	50	82	15
D	4	67	2	13	5	25	1	20	5	31	17	37	51	10
1st phalange	1	17	1	7	2	5	2	40	2	6	8	5	18	1
2nd phalange	—		—		1	5	—		—		1	2	2	
3rd phalange	—		—		—		—		—		—		—	
Pelvis with acetabulum	5	83	14	93	16	80	2	40	7	44	44	96	88	16
Femur P	—		3	20	1	5	—		1	6	4	9	40	7
D	1	17	5	33	3	15	—		—		9	20	46	9
Tibia P	1	17	3	20	3	15	1	20	1	6	9	20	36	7
D	2	33	5	33	11	55	3	60	10	63	31	67	155	29
Calcaneum	—		—		1	5	—		1	6	2	4	15	3
Astragalus	—		1	13	1	5	1	20	1	6	4	9	9	2
Metatarsal P	5	83	3	20	4	20	1	20	1	6	14	30	96	18
D	—		3	20	3	15	—		1	6	7	15	46	9
Atlas	—		—		1	10	—		—		2	4	19	7
Axis	—		2	27	1	10	1	40	3	38	7	30	17	6
Cervical vert.	—		1		1		1		3		6		32	
Thoracic vert.	3		3		5		2		3		16		44	
Lumbar vert.	1		1		3		2		3		10		50	
Sacrum	—		1		—		—		—		1		3	
Vert. frags.	1		8		3		3		4		19		69	
Upper teeth	3		5		9		3		5		25		145	
Lower teeth	2		6		17		8		13		46		296	

less marked discrepancy between the numbers of mandibles and of other bones. In the medieval groups, although mandibles are well represented, they are not the best represented bones — distal humeri and pelvis are each better represented. This leads to several possible conclusions. The medieval pattern could represent the 'normal' pattern, with survival and recovery of mandibles high, but not disproportionately high. This would suggest that the large numbers of Saxon mandibles might be due to the presence of butchery waste, and that the 'minimum number of individuals' figures, based as they are on the numbers of mandibles as the most frequently occurring bones, will greatly overestimate the numbers and proportion

EXCAVATIONS AT PORTCHESTER CASTLE

TABLE III—*continued*

Period	1		2		3		4		6		Total		Saxon total	
	No.	%	No.	%	No.	%	No.	%	No.	%	No.	%	No.	%
<i>c. Pig</i>														
Skull	3		8		5		2		2		20		176	
	—		(5)		(5)		(2)		(5)		(17)		(84)	
Orbit	1	17	3	23	3	23	1	—	—	—	8	22	59	12
Upper jaw	2	33	3	23	9	69	3	—	—	—	17	46	210	42
Mandible	6	100	13	100	13	100	2	—	—	—	37	100	495	100
Scapula D	4	67	2	15	3	23	1	—	1	—	11	30	60	12
Humerus P	—		1	8	1	8	—	—	—	—	2	5	14	3
D	—		3	23	7	54	—	—	—	—	10	27	54	11
Radius P	4	67	3	23	7	54	—	—	1	—	15	41	41	8
D	—		4	30	2	15	—	—	—	—	6	16	12	2
Ulna P	3	50	2	15	13	100	2	—	—	—	20	54	56	11
Metacarpal P	3	33	4	15	7	31	1	—	1	—	16	22	48	5
D	3	33	3	15	5	23	1	—	1	—	13	19	40	4
1st phalange	—		1	8	1	8	—	—	—	—	2	5	17	1
2nd phalange	—		1	8	—	—	—	—	1	—	2	5	5	
3rd phalange	—		—	—	—	—	—	—	—	—	—	—	1	
Pelvis with acetabulum	1	17	2	15	8	62	—	—	1	—	12	32	66	13
Femur P	1	17	—	—	6	46	—	—	—	—	7	19	11	2
D	1	17	—	—	4	31	—	—	—	—	5	14	16	3
Tibia P	—		1	8	3	23	—	—	1	—	5	14	18	4
D	2	33	2	15	7	54	1	—	2	—	14	38	46	9
Calcaneum	2	33	1	8	5	38	—	—	1	—	9	24	5	1
Astragalus	—		—	—	5	38	—	—	—	—	5	14	11	2
Metatarsal P	—		2	8	7	31	—	—	1	—	10	14	44	4
D	—		1	8	7	31	—	—	—	—	8	11	34	3
Atlas	1	33	1	15	—	—	—	—	1	—	3	16	12	5
Axis	1	33	—	—	—	—	—	—	—	—	1	5	3	1
Cervical vert.	—		1	—	2	—	—	—	—	—	3	—	10	
Thoracic vert.	—		2	—	3	—	—	—	—	—	5	—	26	
Lumbar vert.	1		1	—	2	—	3	—	—	—	7	—	7	
Vert. frags.	1		3	—	3	—	—	—	2	—	9	—	53	
Upper teeth	2		2	—	6	—	1	—	1	—	12	—	482	
Lower teeth	10		15	—	19	—	12	—	7	—	63	—		

Key: P = proximal; D = distal.

The first skull figure includes all large fragments. The second figure (in brackets) includes all small fragments, mainly pieces of frontal bone.

of sheep actually eaten, at least on the particular area of the site that has been excavated. Alternatively, if the Saxon figures give the 'normal' pattern, the medieval figures will give a distorted picture. What is interesting is that the pattern is roughly the same in all Saxon groups, and in all medieval groups. It is impossible to assess at this stage which explanation is the more valid: it is of course quite possible that neither explanation is right. Each pattern could reflect human activities of different sorts and differential survival in Saxon and

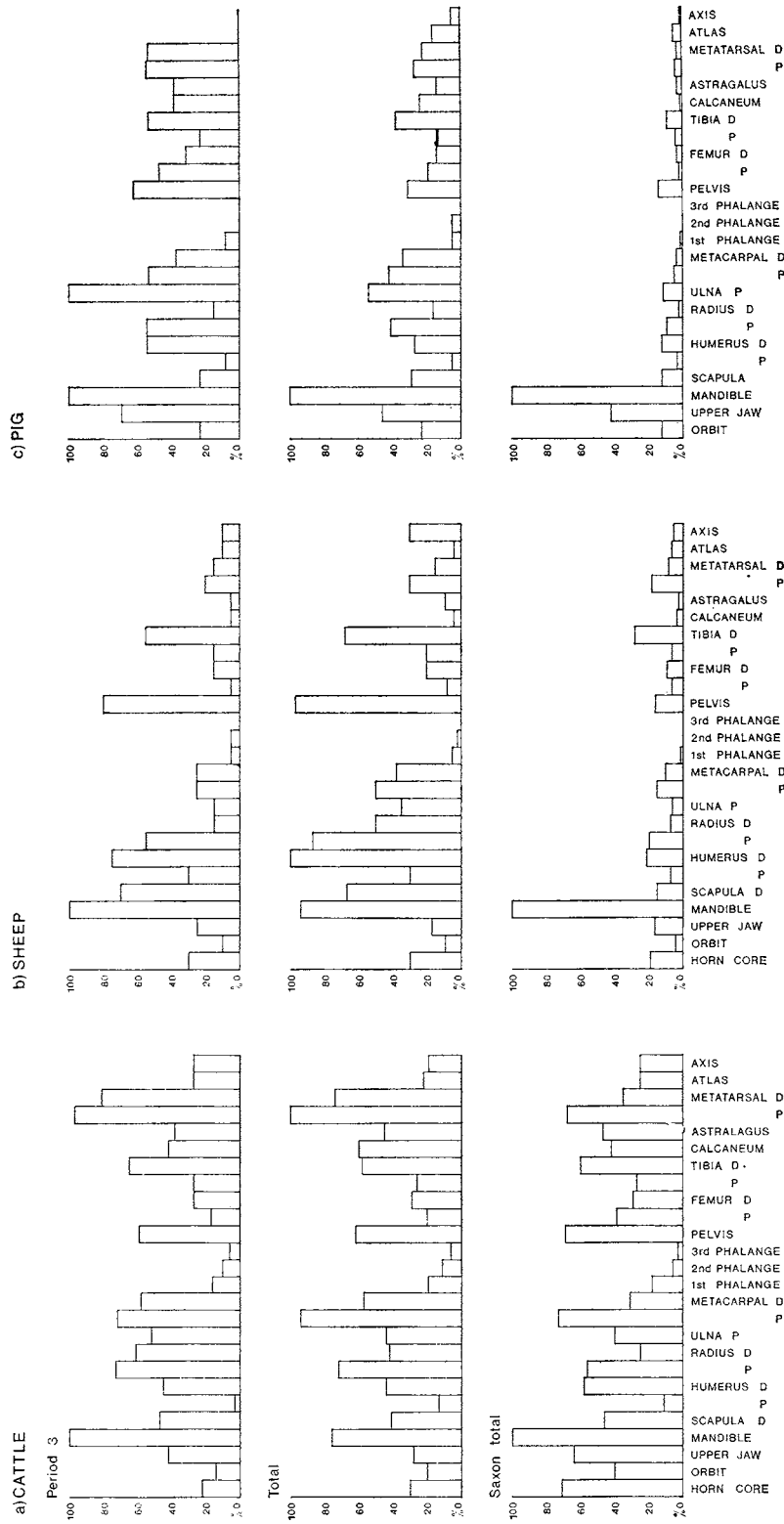

FIG. 115. Histogram of bones represented for cattle, sheep and pig

medieval contexts is another possible explanation. In Brain's (1969) study of the survival of goat bones in an area of south-west Africa, he calculated the percentage of survival of the mandible as 91.4%. The second best represented bone was the distal humerus with a percentage survival of 64%.

Table IIIc and fig. 115 give the results of the analysis of the pig bones. The numbers of bones recovered in all but the first, second and third groups were so small that percentages have only been calculated for these groups. The picture is again one of the survival of the densest, earliest fusing and least chewable bone, suggesting survival and recovery rather than preferential selection of particular parts of the carcass as the main cause of the pattern of distribution. However, comparison between the Saxon and medieval results shows that as in the case of the sheep bones the discrepancy between the numbers of mandibles and other bones recovered is not as marked as in the Saxon sample, although pig mandibles were definitely the best represented bones overall. The difficulty of interpreting samples from partly excavated sites is once again emphasized.

Table IV gives the numbers of rib and skull fragments for all species for all groups. Species identification of ribs was not attempted. The percentage of rib bones varied between 22 and 30%. In the Saxon period 20% of the identified bones were ribs and in the Roman period 28%.

TABLE IV

<i>Period</i>	1		2		3		4		6		Total	
	<i>No.</i>	%	<i>No.</i>	%	<i>No.</i>	%	<i>No.</i>	%	<i>No.</i>	%	<i>No.</i>	%
Identified fragments	404	64	825	67	1206	73	259	77	509	72	3203	70
Rib fragments	179	29	371	30	381	23	71	21	185	26	1187	26
Skull fragments	45	7	35	3	63	4	7	2	15	2	165	4
Total	628		1231		1650		337		709		4555	

Evidence of the gnawing of the bones by animals, probably dogs (and/or wolves and foxes) was seen. Cattle, sheep, pig and occasionally horse bones were gnawed. Bones of small animals, including sheep and pigs, may well have been completely destroyed by gnawing. Pig humeri seem to have been particularly frequently gnawed, and no doubt would have survived in greater numbers if dogs had not been kept at the site. A rough calculation was made of the percentage of bones with clearly visible tooth marks in each group. These showed group 1 with 4%, group 2 with 2%, group 3 with 3%, group 4 with 1%, and group 6 with 2%. It is interesting to note that the incidence of gnawed bones is highest in group 1 which had the highest percentage of dog bones. Although the incidence of gnawed bones was lowest in the latest groups, it may be possible to infer that there were some dogs around in these periods, even though no dog bones were recovered. The distal end of a sheep radius with clear tooth marks is illustrated in pl. XLVa.

Evidence of the butchery practices of the medieval inhabitants of the site was seen in the cut

marks found on the bones. As in the Roman and Saxon periods, three types of tool marks were seen, indicating the use of heavy chopping tools, sharp knives and saws (see pl. XLVb-d). The use of the saw was generally confined to deer antler, but pl. XLVe illustrates the distal end of a cow femur that has been sawn through. The sample was not large enough to allow anything more than a brief outline of the butchery practices.

On cattle bones the most frequently occurring butchery marks were chop marks around the epiphyses of the bones. These chop marks seem to have been fairly haphazard — the chop marks on some bones indicate several heavy blows to the same part of the bone as if to separate two bones in a quick and rough fashion (pl. XLVb,f). In other cases the technique does not seem to have been so crude, and the fine knife marks on the cow tibia (pl. XLVg) indicate separation of the femur and tibia by a careful cutting of the ligaments. Horn cores were generally cut from the skull at their base. The practice of splitting the bones longitudinally, probably to facilitate the extraction of the marrow, which was first noted at Portchester in the Saxon period, continued into the medieval period. Split bones were noted in all groups but in none was their occurrence very frequent. Vertebrae were generally found cut at right angles to the line of the spine, but in groups 4 and 6 vertebrae were found that had been split longitudinally along the line of the spine. Were this fact based on a larger sample it would be tempting to conclude that a change in butchery practice had occurred, with animals being hoisted and split in half in the modern fashion prior to butchery into smaller 'joints'.

Sheep bones were seen with both chopper marks and knife marks, generally around the epiphyses of the bones. There is some evidence to suggest that heavy chopping tools were used more commonly on sheep bones in the medieval period than in the Saxon period where knife marks were more common than chop marks. The most economical way to butcher a sheep is by careful separation of the bones using a sharp knife to cut through the ligaments.

Pig bones and a few deer bones were seen with chop marks. In the medieval layers a larger number of very small bone fragments were recovered than in the Saxon and Roman periods. This is reflected in the higher percentage of bone fragments that could not be identified. However, the percentage of complete bones recovered was similar to that of the Saxon period.

There was no specific evidence of the kind of bone fragments that can be interpreted as waste from bone-tool manufacture (see Grant, 1971), so we might conclude that there was no medieval bone-tool industry on this area of the site.

The Age Structure

Analysis of the age at death of the bones of cattle, sheep and pig was attempted by reference to the state of fusion of the long bones and by analysis of the eruption and wear of the teeth, using the methods described in Grant (1975a) and fusion data given by Silver (1969). Table V gives the analysis of the state of fusion of the long bones and this is shown graphically in figs. 116-18 together with the results of the tooth wear analysis. The sample of mandibles was very small and the kind of detailed interpretation of the wear of the teeth that was possible for the Roman and Saxon period was not attempted for the medieval jaws. The small size of the sample is probably also the cause of some of the anomalies seen in Table V, and may

EXCAVATIONS AT PORTCHESTER CASTLE

TABLE V

The Age Structure

Period	1			2			3			4			6			Saxon total
	UF	F	%F	UF	F	%F	UF	F	%F	UF	F	%F	UF	F	%F	
<i>a. Cattle</i>																
10 months	0	2	100	0	2	100	0	12	100	0	2	100	0	1	100	93
12-18 months	0	6	100	0	17	100	2	53	96	0	13	100	1	7	88	95
2-2½ years	0	6	100	2	13	87	7	56	89	0	5	100	1	12	92	89
3-3½ years	1	2	67	0	3	100	6	7	54	1	2	67	1	6	86	58
3½-4 years	2	3	60	3	4	57	22	10	31	0	0	0	4	3	43	58
Up to 10 months			0			0			0			0			0	7
10-18 months			0			0			4			0			12	5
1½-2½ years			0			13			7			0			2	6
2½-3½ years			33			30			35			33			43	31
3½-4 years			7						23			67			43	
Over 4 years			60			57			31			0			43	58
<i>b. Sheep</i>																
10 months	1	8	89	17	24	59	11	40	78	0	9	100	4	32	89	89
1½-2 years	3	3	50	5	6	55	5	15	75	1	3	75	3	12	80	71
2½ years	0	0	0	2	2	50	1	1	50	0	0	0	2	4	67	45
2½-3 years	1	0	0	13	2	13	3	2	40	0	0	0	2	7	78	
3½ years	2	0	0	8	2	20	9	3	25	0	0	0	2	3	60	36
Up to 10 months			11			41			22			0			11	11
10 months-2 years			39			5			3			25			9	18
2-2½ years			50			5			25			75			2	26
2½-3 years						30			10						18	9
3-3½ years									15						60	36
Over 3 years						20			25							
<i>c. Pig</i>																
1 year	1	4	80	2	5	71	5	20	80	Not calculated						84
2-2½ years	4	3	43	7	0	0	21	2	8	Not calculated						39
3½ years	2	1	33	7	0	0	18	1	5	Not calculated						15
Up to 1 year			20			29			20	Not calculated						16
1 to 2½ years			37			71			72	Not calculated						45
2½ to 3 years			10						3	Not calculated						24
Over 3 years			33						5	Not calculated						15

Key: F = fused; UF = unfused

well be the cause of some of the apparent differences in the age structure of the animals of different groups.

The analyses of the cattle bones are seen in Table Va and fig. 116. The group 3 results (the only group with an adequate sample) show that the majority of the animals had been killed between 2½ and 3½ years, and that only 31% of the bones were from animals of more than four years. In both Saxon and Roman periods between 50 and 70% of the animals were over

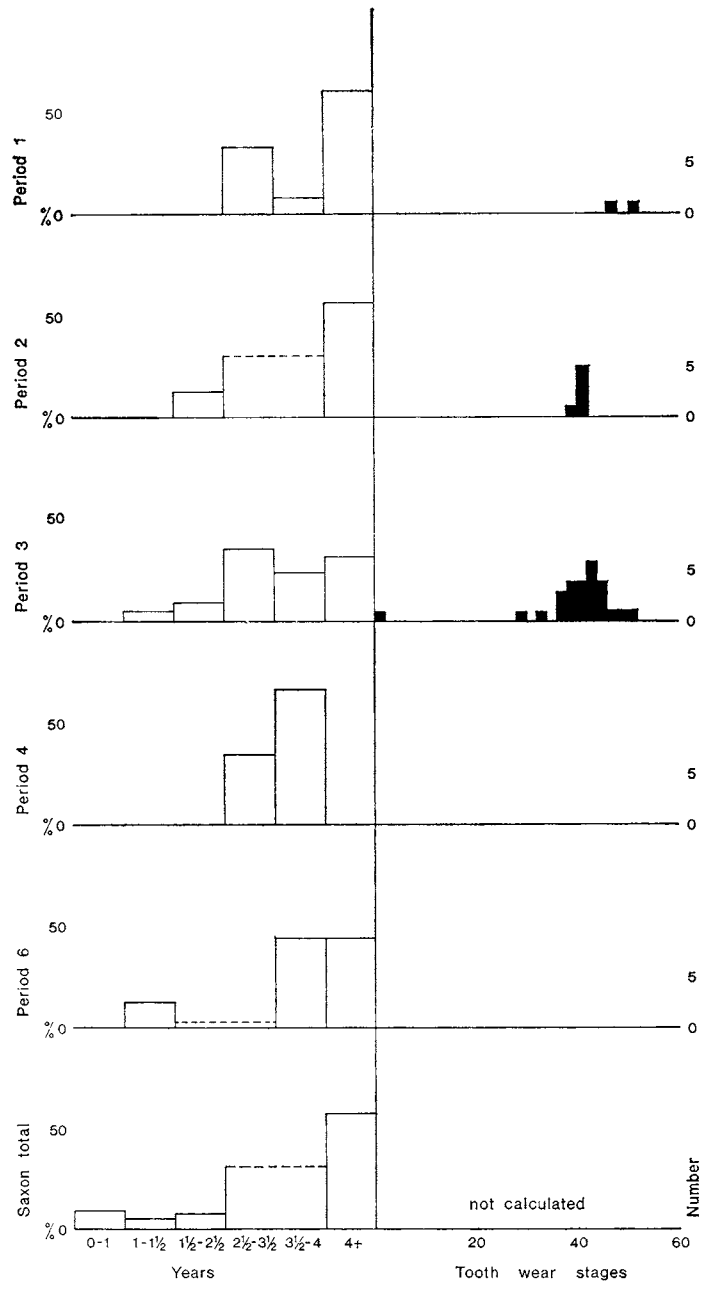

FIG. 116. Age structure of cattle bones

EXCAVATIONS AT PORTCHESTER CASTLE

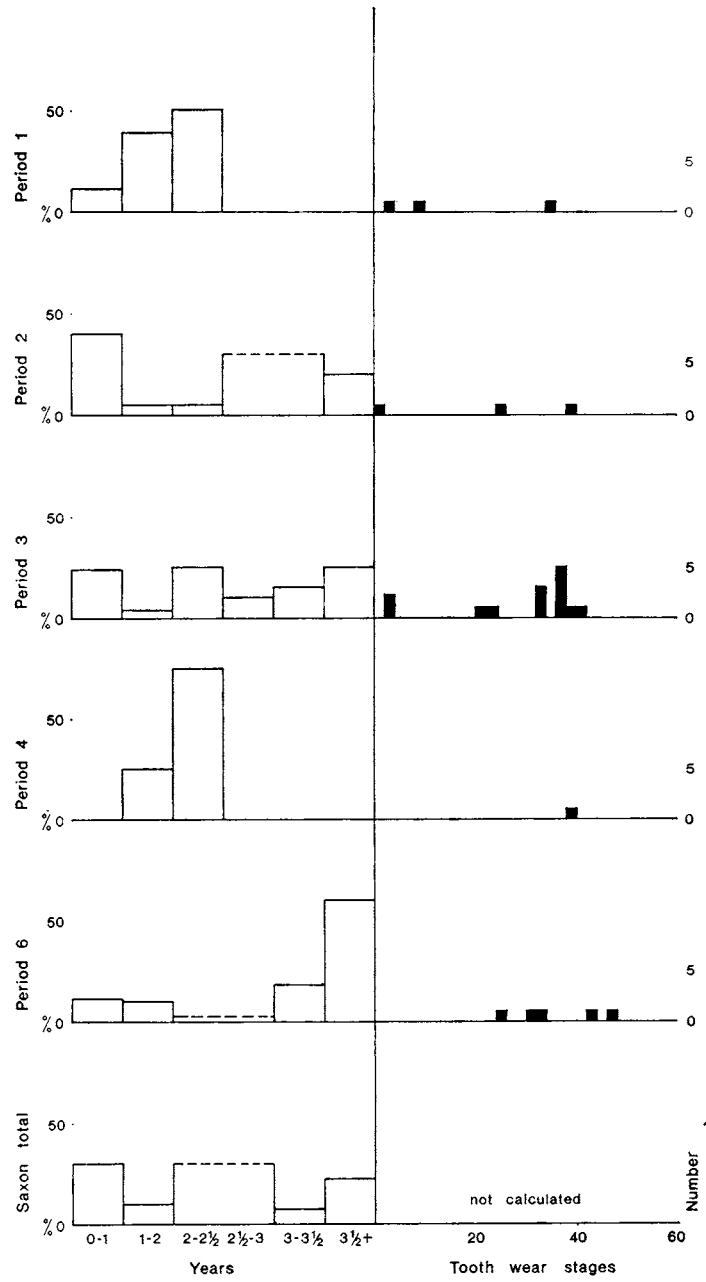

FIG. 117. Age structure of sheep bones

four years old. In a society where cattle were bred mainly for traction, and not generally killed until they were between five and ten years old (Stamp, 1969) this result is perhaps surprising. The tooth wear results show that only three mandibles were below stage 38, and that the majority were at stage 42 or more. These wear stages suggest fairly mature animals. The epiphyseal fusion analysis may indicate that the animals eaten at the site do not necessarily represent a true picture of the age structure of the livestock of the society as a whole.

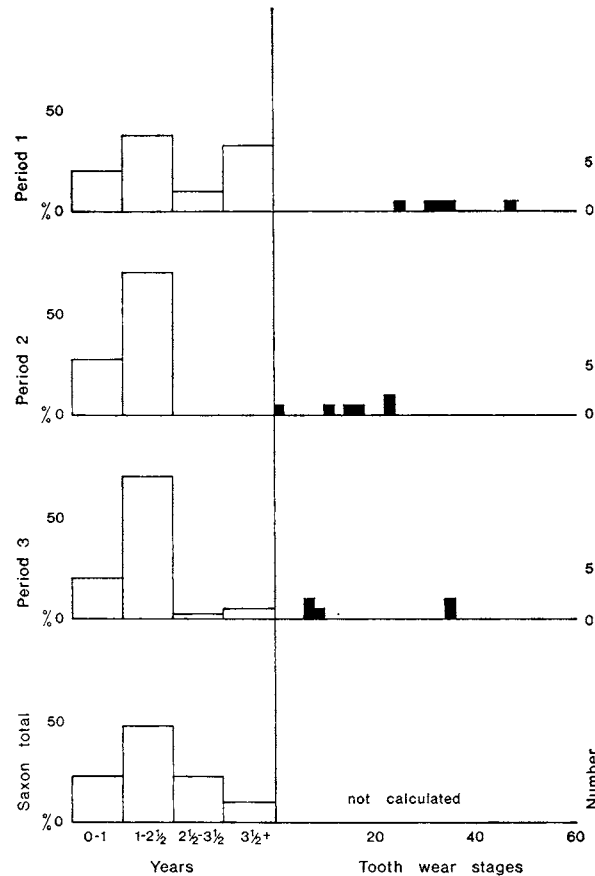

FIG. 118. Age structure of pig bones

In the two earliest periods the picture is similar to that of the Saxon period, with about 60% of the bones from fully mature animals. In all groups except group 6 between 30 and 35% of the animals seem to have been killed between 2½ and 3½ years. These may have been animals killed specifically for food, not required for either traction or breeding purposes. The absence of any mature animals in group 4 is probably due to the small size of the sample. Of the six mandibles dated to group 2, five were at stage 41 and the sixth at stage 40. This may indicate an 'autumn killing' of cattle. Authorities differ on this matter, as Slicher van Bath (1963) maintains there was no general autumn killing, while Stamp (1969) claims that cattle were killed at Martinmas because of the shortage of winter fodder.

Table Vb and fig. 117 give the analyses of the sheep long bones and mandibles. There are marked differences from group to group, but again sample size must be a contributory factor to these differences — the sample for group 4 was especially small. In period 1, the long bone analysis indicates that there were no animals older than $2\frac{1}{2}$ years, but of the three mandibles aged in this group, one appears to be about three or four years old. In group 2, 41% of the animals were less than one year old, but 20% were kept beyond $3\frac{1}{2}$ years. The three mandibles are from new born to mature animals. In group 3 the bones come from animals killed at all ages from under one year to over $3\frac{1}{2}$ years. The most common ages to kill the sheep seem to be under one year, 2– $2\frac{1}{2}$ years, and over $3\frac{1}{2}$ years. The mandibles represent two young animals, two 1–2 year old animals and 12 animals ranging in age from $2\frac{1}{2}$ to about eight years old. Approximately 40% of these jaws were at stages 37–39, which, tentatively, may indicate animals of 3–4 years of age. Precise correlation between tooth wear stage and actual age is very difficult at the present time. Group 6 had the highest percentage of mature animals — the epiphyseal fusion data indicates that 60% of the bones were from mature animals. It was in group 6 that the highest percentage of sheep bones occurred. These two facts together may indicate an increase in the importance of wool production at this time.

Table Vc and fig. 118 give the analyses of the pig bones and mandibles. Too few pig bones were recovered from groups 4 and 6 for this analysis to be attempted for these periods. The pig bone analyses give a more consistent picture from group to group than do the analyses of the cattle and sheep bones. In all three groups analysed, the majority of the pigs were between one and $2\frac{1}{2}$ years at death. Group 1 had the highest percentage of mature pigs, and the age structure of the animals in this period was most like the age structure of the Saxon pigs. In all three groups between 20 and 30% of the animals were under one year old. The analysis of the tooth wear of the few pig mandibles indicated a majority of fairly young animals, with the oldest pig in group 1.

The tooth wear analyses for all three animals suggested that the age at eruption of the teeth had not changed since Saxon times.

Metrical Analyses

Bones were measured when their condition made it possible. It is planned to include a full discussion of the metrical analyses of the bones in the final volume of the Portchester reports when all periods can be compared.

Table VI gives the range and number of measurements of the distal width of the tibia and length and distal width of the metatarsals. These measurements were used by Jewell (1962) in his study of size changes in British cattle. The Portchester medieval measurements are compared with the Portchester Saxon and Roman measurements, and the measurements from Northolt, Petergate and Kirkstall, the medieval sites cited in Jewell's study.

Jewell concluded that there had been an increase in the size of cattle from neolithic to modern times, with medieval cattle achieving the size of some modern breeds. It is interesting that at Portchester there seems to have been a decrease in the size of the cattle at the site from Roman to medieval times. The Roman metapodial measurements have the widest

TABLE VI
Tibia: Distal Width

<i>Site</i>	<i>Distal width (mm.)</i>	<i>No.</i>
Portchester (medieval)	44-64	20
Northolt	71	1
Petergate	72	1
Portchester (Saxon)	44-70	26
Portchester (Roman)	50-69	143

Metatarsal: Length and Distal Width

<i>Site</i>	<i>Length (mm.)</i>	<i>No.</i>	<i>Distal width (mm.)</i>	<i>No.</i>
Portchester (medieval)	193-224	11	44-59	21
Northolt	203-209	3	48-56	2
Petergate	—	—	47-60	6
Kirkstall	209	1	45-70	118
Portchester (Saxon)	198-232	16	46-63	25
Portchester (Roman)	183-240	103	43-70	172

range of variation, and the medieval the smallest range. This may possibly suggest that there was a change from Roman to medieval times from a varied to a homogeneous cattle population — this may be clarified when the full analysis of the measurements is undertaken.

Disease and Injury

Several bones showed evidence of disease, injury or anomalies. Rehealed fractures were seen on a cattle rib, a dog rib and a dog metapodial.

Several bones had extra bony growth around the articular surfaces, possibly due to arthritic conditions. These included two cattle phalanges, a cattle scapula, a cattle pelvis, a dog femur and two horse carpals that were completely fused together.

A rib, probably from a cow, showed evidence of some sort of inflammatory condition, and the condyle of a cattle mandible showed evidence of some form of osteitis.

A small dog tibia and a rib, possibly from the same animal, both showed evidence of disease. The tibia (pl. XLV*h*) was severely distorted — the shaft was probably reduced, and was bent backwards and sideways at the proximal end. The bone of the proximal epiphysis seemed slightly porous. The rib had an extra growth of bone just behind the epiphysis (pl. XLV*j*).

The part of the skeleton most commonly affected by disease or anomalies is probably the mandible. A curious sheep mandible is illustrated in pl. XLV*k*. The second premolar is absent, and the first and second molars both have extra external pillars on the labial side.

There are two mental foramina, and the depth of the bone below the teeth seems slightly reduced, with a pronounced kink in the line of the jaw just below the third premolar.

Pl. XLV^m illustrates a roe deer mandible showing signs of injury to the bone just below the fourth premolar. The jaw is bent up at an angle at this point, and the premolar itself appears to have been damaged. The injury may have occurred when the tooth was still in the jaw. The bone of the angle of the jaw seems particularly thin and slightly extended.

Several cattle jaws had no second premolars, and others were observed with third molars with only two cusps. These anomalies have been observed in British cattle bones from prehistoric times. One pig jaw with the congenital absence of the second premolar was also noted.

Conclusions and Discussion

Cattle

Since complete or even fairly complete skulls of cattle were not recovered from medieval layers at Portchester, discussion of possible breeds of cattle is not really possible, at least until the full metrical analysis is undertaken. The analysis of the metatarsal measurements indicated a smaller range of sizes than in the Roman period at the site, which could imply a more homogeneous cattle population in medieval than in Roman times.

Cattle were the most important food animals at the site, although their importance may have varied from period to period, and in the second phase and in the latest phase of medieval occupation more sheep than cattle may have been kept.

The analysis of the age structure of the cattle bones indicated that changes might have occurred in the management practices during the medieval occupation. However, the changes in the age structure of bones recovered from mainly domestic contexts do not necessarily reflect changes in the age structure of the animal population as a whole. The relatively small percentage of mature animals in the developed medieval phase may reflect dietary preferences rather than a decline in the numbers of mature animals kept. Analysis of sexual dimorphism was not possible, but it is likely that most of the mature animals would have been oxen, used for traction. Of course cows would have been kept for milk and for breeding too. The value of cattle in the middle ages probably lay more in their use as beasts of burden than in the meat that they produced. During ploughing, eight oxen were generally used to pull the plough, although with the development of improved horse harnesses in some areas horses were used for ploughing (Slicher van Bath, *ibid.*; White, 1969).

Sheep and goats

Only 14 horn core fragments were recovered, and much of the other skeletal material was very fragmentary, so it was not possible to assess the relative importance of sheep to goats at the site, or if goats were in fact kept. There is evidence of at least two types of sheep, one with horns and the other hornless. A further breed may be indicated by the horn core illustrated in pl. XLV^l, which has a marked backwards curve. Hornless sheep are thought by some authorities to be long-haired, while horned sheep are short-haired (see Ryder, 1959; Trow Smith, 1957).

Sheep are second in importance to cattle at the site, but in groups 2 and 6 more sheep than cattle bones were found. In the Saxon period at the site there was a general increase in the

importance of sheep, possibly implying an increase in the importance of wool production. This does not seem to continue, at least in the early medieval period, but the increased numbers of sheep in the latest period together with the larger percentage of mature sheep bones in this group may imply another increase in wool production at this time. The fourteenth and fifteenth centuries were times of agricultural depression, and they saw an increase in the numbers of sheep kept in England because of the high price of wool (Slicher van Bath, 1963).

Pigs

Pigs appear to have been most important at the site in periods 2 and 3, although the different methods of calculating the percentages of species gave varying figures. There was certainly a decline in the numbers of pigs in the latest periods. Perhaps the greatest economic advantage of pigs is that given enough woodland they will more or less feed themselves. In the early middle ages, the main value of woodland lay in the food it provided for pigs — Domesday reckons woodland as 'pannage' for pigs. However, pigs will do a great deal of damage to woodland, and by the thirteenth century woodlands began to be prized as a source of timber (Slicher van Bath, 1963). The decline in the numbers of pigs in the later periods at Portchester may reflect increased importance in the value of timber from surrounding woodlands, or may reflect a decline in the available woodland for pig fodder.

The value of a pig lies only in the amount of meat it will provide. In Roman, Saxon and medieval periods at Portchester the majority of pigs were killed in their second and third years. The pigs at Kirkstall Abbey and Petergate (Ryder, 1959, 1970) were most commonly killed at around 18 months. Killing pigs at this age must balance meat production and food consumption most economically.

Deer

Red deer, roe deer and fallow deer were all found at the site. There was a marked increase in the percentage of deer bones recovered in the later periods of medieval occupation, notably of fallow deer. Deer provide both meat and, in their antlers, a valuable raw material for tool manufacture. However, they also provide sport, and deer hunting was a popular pastime in the middle ages, so much so that hunting in the Royal forests was protected by very heavy penalties for poachers, especially under the Norman kings (Stamp, 1969). The area to the north of Portchester was a Royal forest, known as the Forest of Bere. Whether the deer bones at Portchester were from animals legitimately killed or poached can only be a matter for speculation.

Horses

Although horse bones do not form a very large percentage of the bones, they are significantly more common in medieval than in Saxon times. Horses generally became more important to agriculture in the middle ages, with the development of an improved harness that made it possible for horses to pull heavy loads. In some areas horses were kept in fairly large numbers (Slicher van Bath, 1963), but although they had the advantage of being swifter and lighter than oxen, they were more expensive to feed.

The fragmentary, but almost complete remains of a horse were found in one pit, and in general the horse bones were found in specific pits rather than scattered throughout the bone refuse. This may imply a particular method of disposal of horses. No butchery marks were observed on horse bones, though several had been gnawed.

Dogs and cats

These animals were most common in the earliest medieval phase at Portchester, and no dog and cat bones at all were recovered in the latest phase, although the presence of dog at least is suggested by the incidence of gnawed bones in all periods. As with horse bones, the dog and cat bones were generally found together in specific pits rather than scattered about the site. Their absence in the latest period may only reflect a particular method of disposal of dog and cat carcasses. Measurement of the dog bones indicated a wide range of sizes, and one very large animal, represented by several bones, found in pit 30, may in fact have been a wolf. At the medieval settlement at Lyveden in Northamptonshire, three very large bones were tentatively identified as wolf, although they could have been from a very large dog (Grant, 1975b).

Birds

Bird bones are the subject of a separate report (pp. 233-9). Bird bones were relatively common at the site, and form about 21% of the total (using the method for calculating percentages which is likely to show the least bias against the representation of small animals). They fluctuate in importance from group to group, but form 41% in group 2. Such large numbers of birds are unusual on medieval sites in general. The fact that much of the bone material from Portchester was recovered from the pits, which provide a fairly protected environment and probably increase the chance of survival of small bones, may be one of the causes of their large numbers. Comparison of the numbers of bird bones recovered from the pits and gullies of group 3 supports this view.

Fish, mice, rabbits and hares

The bones of small wild animals were recovered in very small numbers. The range of wild animals was smaller in the medieval than in the Saxon period, when frogs, foxes, badgers and voles were also found. The numbers of fish bones may well not reflect the importance of fish in the diet of the inhabitants of the site, since they are both small and very susceptible to decay.

This collection of animal bones provides many problems in interpretation. If the animal bones represent domestic refuse, as seems reasonable, it is not clear whose domestic refuse they are. The bones may have derived from the fairly meagre occupation of the outer bailey, or they may include rubbish from the castle, whose occupants may be expected to have had a better standard of living. More light will be thrown on this problem when the analysis of the bones from the inner bailey has been completed.

Because the numbers of animal bones recovered from the different periods of medieval occupation are not equal, changes between the various phases may be exaggerated or even caused by the differences in sample size.

These problems mean that it is possible to come to only very general conclusions about the nature of the economy of the site. The animal husbandry seems to have been based on cattle and sheep, with pigs of lesser importance in most periods. Horses were kept, and were slightly more important than in the Saxon period at the site. Deer, especially fallow deer, increased in importance during the medieval occupation, though it is not possible to say whether this represented an increased love of or opportunity for hunting, or a need in the later periods to supplement the amount of meat obtained from the domestic animals. There is some continuity from Saxon to medieval times, especially in the general proportions of the most commonly represented animals. A more detailed examination reveals the possibility of changes in the nature of the animal husbandry, especially in the later medieval periods.

It would be unwise to draw any general conclusions about medieval economy or agriculture from the Portchester results. Slicher van Bath's study of animal husbandry in the later middle ages has shown that there was a great variety in the agricultural practices of the period, and published bone reports show a similar variety.

BIRDS

BY ANNE EASTHAM

The groups of bird bones were divided into five chronological groups according to the categories outlined above (p. 213). The species represented may be summarized as follows:

Saxo-Norman (1000-1100)

<i>Anas crecca</i>	Teal
<i>Aythya ferina</i>	Pochard
<i>Gallus gallus</i>	Chicken
<i>Corvus corax</i>	Raven

Early Medieval (1100-1200)

<i>Anser anser</i>	Domesticated goose
<i>Anas platyrrhynchos</i>	Duck, probably domesticated
<i>Gallus gallus</i>	Chicken
<i>Accipiter gentilis</i>	Goshawk
<i>Accipiter nisus</i>	Sparrowhawk
<i>Circus aeruginosus</i>	Marsh harrier
<i>Scolopax rusticola</i>	Woodcock
<i>Alauda arvensis</i>	Lark
<i>Corvus corax</i>	Raven
<i>Corvus corone</i>	Crow

Developed Medieval (1200–1300)

<i>Gallus gallus</i>	Chicken
<i>Accipiter gentilis</i>	Goshawk

Late Medieval (1300–1400)

<i>Gallus gallus</i>	Chicken
----------------------	---------

Painted Ware Phase (1470–1570)

<i>Anser anser</i>	Domesticated goose
<i>Anas platyrhynchos</i>	Duck
<i>Gallus gallus</i>	Chicken
<i>Numenius phaeopus</i>	Whimbrel
<i>Columba livia</i>	Rock dove
<i>Sturnus vulgaris</i>	Starling

The Saxo-Norman Period (1000–1100)

The few bird bones for this early period come from a number of pits: there is very little except chicken, which comprises 28 out of the 32 bones for these levels. Even the chicken bones suggest that there were not likely to be many more than five fowls of whom two were cock birds. There was certainly one and could have been two ravens on the evidence of a coracoid and an ulna found in pit 110. The only other bones were two humeri, of teal and pochard respectively, which came from pit 30.

The Early Medieval Period (1100–1200)

The birds found in rubbish pits belonging to this period are the most interesting and varied of all the later levels at Portchester. They total 183 in all, but 139 of these were chicken bones, representing a minimum of 12 individuals, of whom perhaps four or five were cocks.

Other domesticated species include geese, many of whom were rather small, nearer to the size of the wild bean goose than the grey lag from which domesticated species derive, and which, in modern breeding, they usually rival in size. Altogether there were 12 goose bones, all from pit 99 representing two or possibly three birds. Besides the geese, pits 99, 100 and 161 contained a few duck bones of mallard, probably of domesticated varieties.

Perhaps the most interesting of the species belonging to this period at Portchester are the goshawk and the sparrowhawk. The sparrowhawk is represented by a single tibiotarsus found in pit 29 but there is a series of matched bones from what seems to be a single skeleton of goshawk from pit 99. It is perhaps relevant in this context to remember the often quoted passage from the later *Boke of St Albans* of about 1486:

An Eagle for an Emporer, a Gyrfalcon for a King,
 a Peregrine for a Prince, a Saker for a Knight,
 a Merlin for a Lady, a goshawk for a yeoman,
 a Sparrowhawk for a priest, a musket for a holy water Clerk,
 a Kestrel for a knave.

TABLE VII
Bird Bones: Saxo-Norman, 1000-1100

	Anas crecca		Aythya ferina		Gallus gallus		Corvus corax	
	L	R	L	R	L	R	L	R
Skull								
Mandible—upper								
—lower								
Coracoid					2	3	1	
Sternum					1			
Furcula								
Scapula					1			
Vertebrae								
Ribs								
Pelvis					4			
Humerus	P	1	1	1	1			
	D							
Radius	P							
	D							
Ulna	P				1	1	1	
	D							
Carpo-Metacarpus	P					1		
	D							
Digits								
Femur	P							
	D							
Tibio-Tarsus	P				1	3		
	D							
Fibula								
Tarsus-Metatarsus	P				5	3		
	D							
Phalanges								
Total	1		1	2	8		2	

The single marsh harrier of course does not fall into the same category. More probably, since they are voracious hunters, this one was caught preying on young lambs on the marsh in spring, and shot in consequence.

Game was not of any particular importance either at this period. A single woodcock and a lark were both most likely eaten but the species were not apparently of any real significance.

Pit 99 contained both a single bone of raven and a crow. The latter was perhaps shot as vermin but the raven as a species was a resident of long standing at Portchester and bones have appeared in all levels from Roman times onwards.

EXCAVATIONS AT PORTCHESTER CASTLE

TABLE VIII
Bird Bones: Early Medieval, 1100-1200

	Anser (domesticated)		Anas platyrhynchos (domesticated)		Gallus gallus		Accipiter gentilis		Accipiter nitens		Circus aeruginosus ♀		Scolopax rusticola		Alauda arvensis		Corvus corax		Corvus corone		
	L	R	L	R	L	R	L	R	L	R	L	R	L	R	L	R	L	R	L	R	
Skull																					
Mandible—upper	1		1		1																
—lower					3																
Coracoid					5	6	1														
Sternum	1				4																
Furcula					2																
Scapula					3	3															
Vertebrae																					
Ribs	2				9																
Pelvis	1				12																
Humerus	P				1	9	6	1				1	1	1	1					1	1
	D																				
Radius	P	1	1		1	3	5	1	1												
	D																				
Ulna	P	2	1		11	7	1	1			1	1		1			1				1
	D																				
Carpo-Metacarpus	P	1	1		1	1	1														
	D																				
Digits																					
Femur	P		1		6	5	1	1													1
	D																				
Tibio-Tarsus	P	2	1		12	10			1												1
	D																				
Fibula							1														
Tarsus-Metatarsus	P	1			7	8	1	1													1
	D																				
Phalanges																					
Total		12		4	139		10		1		3		3		1		1				8

The Developed Medieval (1200-1300) and Late Medieval Periods (1300-1400)

Birds are rare during these centuries at Portchester. From the early levels only 15 bones in total were recovered, of which one was too fragmentary to be successfully identified. One radius belonged to a goshawk and the remainder were of chicken. From the tarsus bones it is clear that there were at least four fowls, one of which had the spurs of a cock bird. The same absence of bird remains persists during the subsequent period. Two chicken bones were the only avian finds of any kind.

THE ANIMAL BONES

TABLE IX
Bird Bones: 1200-1550

	Developed medieval (1200-1300)				Late medieval (1300-1400)	Painted ware period (1470-1550)													
	Gallus gallus		Accipiter gentilis			Gallus gallus		Anser (domesticated)		Anas platyrhynchos (domesticated)		Gallus gallus		Numerius phaeopus		Columba livia		Sturnus vulgaris	
	L	R	L	R		L	R	L	R	L	R	L	R	L	R	L	R	L	R
Skull																			
Mandible—upper																			
—lower																			
Coracoid											1	1							
Sternum											1								
Furcula	1																		
Scapula											1								
Vertebrae																			
Ribs					1						1								
Pelvis	1																		
Humerus	P	1	1		1		1										1	1	
	D																		
Radius	P			1											1				
	D																		
Ulna	P									1				1	1	1			
	D																		
Carpo-Metacarpus	P																		
	D																		
Digits																			
Femur	P		2																
	D																		
Tibio-Tarsus	P	1								1	1								
	D																		
Fibula																			
Tarsus-Metatarsus	P	3	3																
	D													2	1				
Phalanges																			
Total		13	1		2		4	2	9	3	1	2							

The Painted Ware Period (1470-1570)

The finds from gully 9, which belongs to this phase, include a few bird bones totalling 21, but nothing particularly noteworthy.

The domesticated species include goose, duck and chickens, though not large numbers. There may have been only one goose, a duck and perhaps two or three chickens.

The three whimbrel bones also seem to have belonged to a single bird. As in preceding periods this too was probably eaten. The other two species, rock dove and starling, complete the very limited picture of bird life on the site at this time.

Conclusions

The history of birds in Portchester between the year 1000 and the sixteenth century appears on present evidence to be a history of decline, but it should be remembered that the centre of occupation had by this time become centred on the castle in the north-west corner of the enclosure. Any generalizations are hampered by the small sample.

During the late Saxon and early Conquest period finds are very few and of limited interest. Smaller numbers even of chicken bones were found than in previous periods. There is an apparent increase in poultry production in the next century, accompanied by a wider variety of other species, especially the birds of prey, of whom it may be suggested that two were domesticated. For subsequent periods, on the basis of the birds alone, the almost complete disappearance of all specimens except the odd chicken implies a drastic reduction in farm production and hunting activities. By comparison with the birds of earlier times one must assume either a change in the social function of this part of the castle, or that some arrangements different from those of Roman and Saxon times were introduced to deal with the disposal of rubbish — or that a partial abandonment of the excavated area of Portchester Castle occurred during these later periods. The archaeological and historical evidence shows that all these explanations are in part true.

BIBLIOGRAPHY

- BRAIN, C. 1969. *The Contribution of the Namib Desert Hottentots to an Understanding of Australopithecine Bone Accumulations*. Scientific Papers of the Namib Desert Research Station, 39, pp. 13-22.
- EASTHAM, A. 1975. 'The Bird Bones.' In Cunliffe, B. W., *Excavations at Portchester Castle*. Volume I: *Roman*. Society of Antiquaries Research Report.
- EASTHAM, A. 1976. 'The Bird Bones.' In Cunliffe, B. W., *Excavations at Portchester Castle*. Volume II: *Saxon*. Society of Antiquaries Research Report.
- GRANT, A. 1971. 'The Animal Bones.' In Bryant, G. F. and Steane, J. M., 'Excavations at the Deserted Medieval Settlement at Lyveden, Northants.' *Northants. Mus. J.* ix, 90-3.
- GRANT, A. 1975a. 'The Animal Bones.' In Cunliffe, B. W., *Excavations at Portchester Castle*. Volume I: *Roman*. Society of Antiquaries Research Report.
- GRANT, A. 1975b. 'The Animal Bones.' In Bryant, G. F. and Steane, J. M., 'Excavations at the Deserted Medieval Settlement at Lyveden.' *Northants. Mus. J.* xii, 152-7.
- GRANT, A. 1976. 'The Animal Bones.' In Cunliffe, B. W., *Excavations at Portchester Castle*. Volume II: *Saxon*. Society of Antiquaries Research Report.

- ISAAC, G. L. 1967. 'Towards the Interpretation of Occupation Debris: Some Experiments and Observations.' *Kroeber Anth. Soc. Papers* xxxvii, 31-57.
- JEWELL, P. A. 1962. 'Size Changes in Size and Type of Cattle from Prehistoric to Medieval Times in Britain.' *Z. Tierz. ZüchtBiol.* xxviii, 159-67.
- RYDER, M. L. 1959. 'The Animal Remains Found at Kirkstall Abbey.' *Agric. Hist. Rev.* vii, 1-5.
- RYDER, M. L. 1970. 'Animal Remains from Petergate, York, 1957-8.' *Yorks. Arch. J.* xliii (4), 418-28.
- SILVER, I. A. 1969. 'The Ageing of Domestic Animals.' In Brothwell, D. and Higgs, E. S., *Science and Archaeology*, pp. 250-68 (London).
- SLICHER VAN BATH, B. H. 1963. *The Agrarian History of Western Europe, A.D. 500-1850* (London).
- STAMP, L. D. 1969. *Man and the Land* (London).
- TROW-SMITH, R. 1957. *A History of British Livestock Husbandry*, Vol. I.
- WHITE, L. 1969. 'The Expansion of Technology, 500-1500,' *Fontana Economic History of Europe*, Vol. 1, Ch. 4 (London).

IX. SUMMARY AND SYNTHESIS

IN the preceding pages, the excavations undertaken within the outer bailey and upon the defences of the castle have been described in some detail and related to the documentary history of the site. Since each section is, or should be, self-contained there is little to be gained from an extended discussion at this point. Nor would such a discussion be of much value without taking into account the development and archaeology of the inner bailey and, so far as it is possible, of the village itself. Until the work on these two projects has been completed and presented in published form, no detailed assessment of medieval Portchester is possible. In the following section a brief summary is given of the major points raised by the excavation.

Throughout the late Saxon period Portchester was occupied by a community, apparently including men of some rank, who were able to erect substantial buildings of timber and a tower-like structure in masonry. The implication would seem to be that the occupants of that part of the enclosure so far excavated were above peasant level, the main complex perhaps representing a thegn's residence. Indeed, it is possible that the hall mentioned in Domesday is to be equated with the excavated establishment. The archaeological record shows that during the eleventh century, probably as a result of the Conquest of 1066, the buildings were abandoned, except perhaps for the tower, which may have continued to serve as a focus for a small burial ground (Vol. II, *passim*).

With the assignment of the previously divided manor together with the castle to William Mauduit immediately following the Conquest, attention soon turned to converting the Roman walls into a secure defensive position, to serve as one of the series of coastal strong-points along with Dover, Hastings, Pevensey and Corfe. The earliest recognizable Norman work included the building of the landgate, possibly some renovation of the watergate, the blocking of the Roman postern gates and probably the construction of a defended hall complex in the north-west corner of the enclosure. Of this last little is now visible, with the exception of the inner bailey ditch which is likely to represent a recut version of its early Norman predecessor. The date of these works is difficult to establish with precision, but probably lies within a decade or two of 1100. The initial preparations were closely followed by the construction of the inner bailey wall and the first stage of the building of the keep.

Within the rest of the enclosure activity was at first slight, but in the late eleventh or early twelfth century a series of boundary ditches was dug to divide the land in the southern part of the fort into plots, in all probability for agricultural purposes. A few cesspits were dug during this period, but no other signs of activity other than ploughing could be recognized.

One of the parcels of land, the north-west corner of which projected into the excavated area, may have been set aside for the church. Alternatively the ditches may have been dug to delimit land already under church control. At any event it was within this area that an Augustinian priory was founded early in the twelfth century (by 1133) only to be abandoned by its inmates within 20 years in favour of the seclusion of a new location at Southwick.

At about this time the central part of the fort seems to have been subjected to heavy traffic, giving rise to deeply scored wheel or sledge tracks, possibly resulting from the transport of building material to the priory site at the time of construction.

Throughout the twelfth century the castle was maintained as a front-line defence. It was probably during this time that the form of the present village began to take shape arranged along a large triangular green which may originally have spread up to the west wall of the castle. Portchester at this stage had pretensions to borough status, but it failed to receive a charter of incorporation and gradually declined in importance throughout the thirteenth century as Portsmouth grew to dominance.

The first half of the thirteenth century saw little activity in the southern part of the fort. Some of the ditches were maintained and recut, while a few cesspits were dug close to the wall, possibly for the convenience of those on guard duty. It may have been at this time that a new south postern gate was cut through the old Roman wall to provide access to the berm outside the wall. The defences were kept in repair — a process requiring quantities of lime. It was perhaps for the repairs undertaken in 1296 that limekiln 1 was built.

The strip of land which immediately flanks the south side of the main east-west road appears to have been the scene of some building activity in the thirteenth and fourteenth centuries since many of the postholes found here can definitely be shown to be medieval and quite possibly a high percentage of the undated examples also belong to this period. The nature of the structures represented is, however, elusive. One possibility is that they were the houses of castle employees: alternatively they may have been stalls for the animals belonging to the garrison. The absence of associated floor levels hinders further useful discussion.

Throughout much of the fourteenth century the castle was kept in a state of defensive readiness against the threat of French attack. Both of the main gates were refitted in the 1320s and the watergate was further extended by an external addition probably in 1369. Walls, bastions and ditches were also maintained and it may well have been to provide mortar for the heightening of the walls and towers recorded to have taken place in 1369 that limekiln 2 was built. It was during this period, perhaps during the initial works of 1320-7, that the medieval south postern gate was blocked up, no doubt to provide greater security.

Among the defensive works undertaken to protect the castle was the construction of an outer earthwork, consisting of a bank and ditch, which commanded the landward approach to the site. There is now some reason to suppose that it was constructed within the period 1320-40. A work of such magnitude may well have necessitated the clearing away of part of the 'town', which clustered outside the castle, and the truncation of the village green. This suggestion has not yet been tested by excavation but is plausible on topographical grounds.

Within the outer bailey several buildings of the fourteenth century have been located, together with associated occupation levels. Building M1 was built against the east wall adjacent to the north side of the watergate, while an examination of the curtain wall face on the south side of the gate suggests the one-time presence of a further building here. In the south-west quarter of the enclosure, two timber buildings were recovered, building M2, modified on at least one occasion, and building M3 built against the south fort wall and incorporating the floor space of a bastion. It is possible that the next bastion to the east,

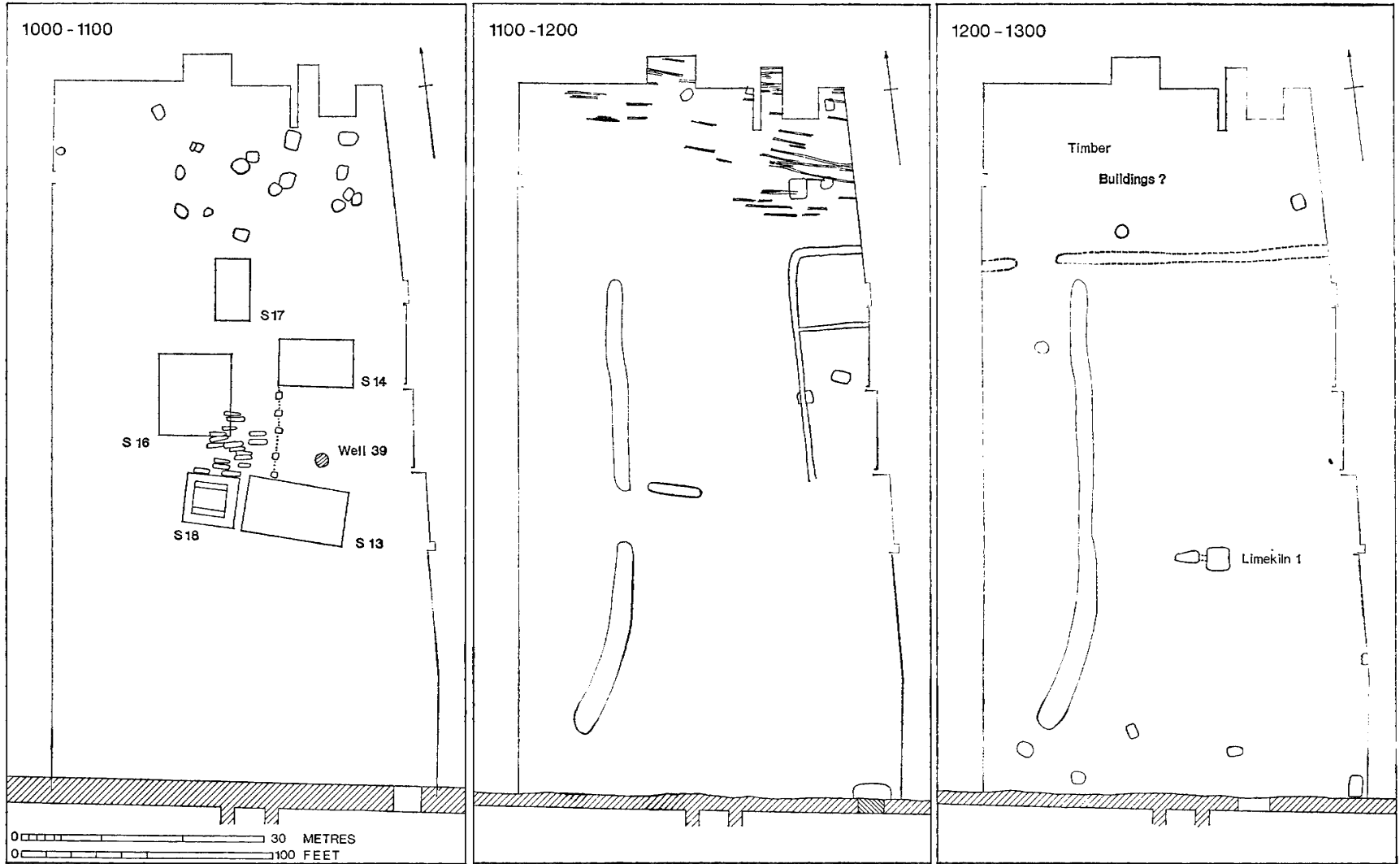

FIG. 119. Summary plans of early medieval occupation

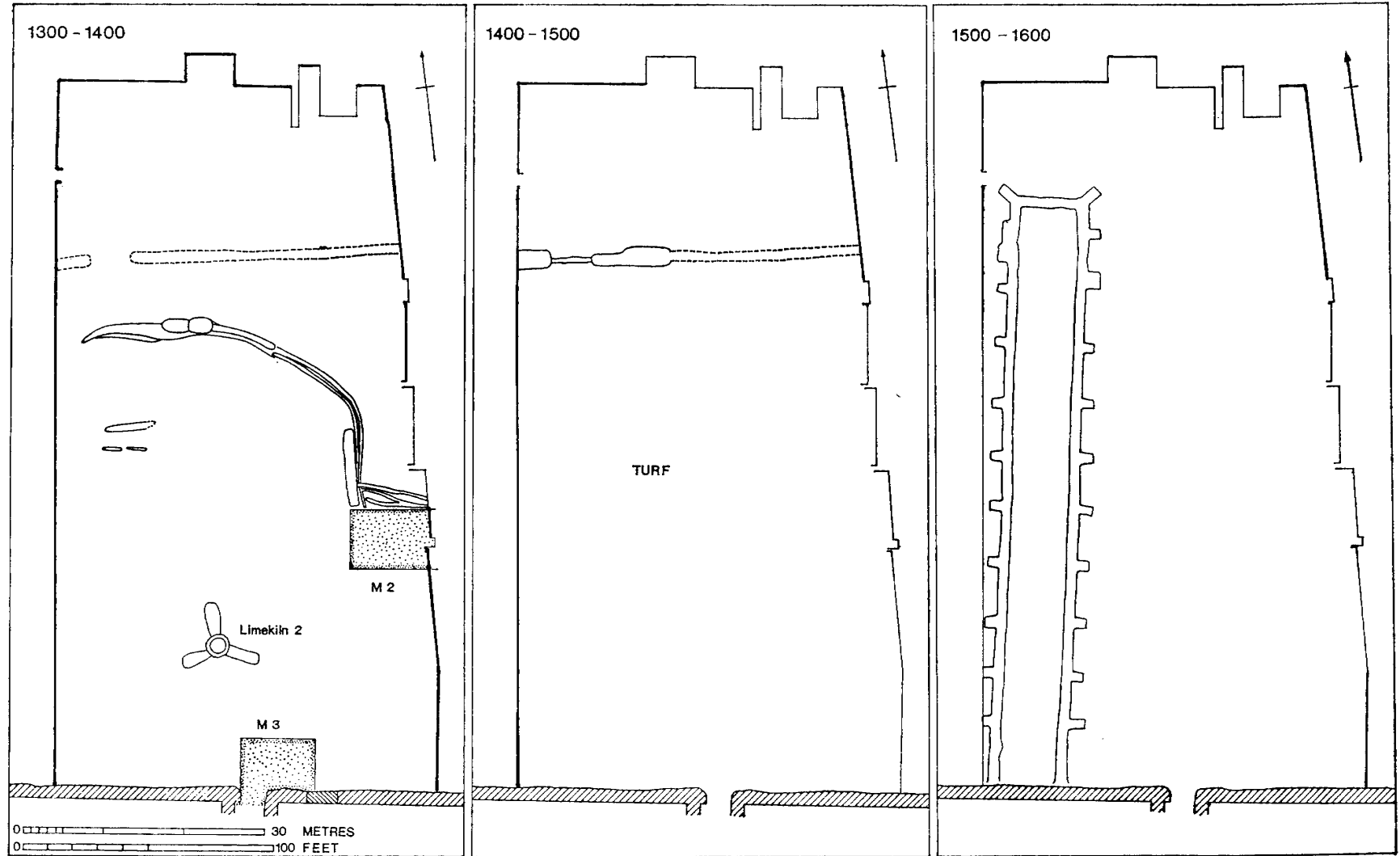

FIG. 120. Summary plans of later medieval occupation

which was also opened up at the base in the medieval period, was associated with an attached building now within the area of the churchyard. Building M2 was provided with a series of drainage gullies leading to a soakaway pit. Pottery associated with it was plentiful and included a few sherds of vessels imported from northern France. Exotic fabrics of this kind have not yet been found elsewhere within the outer bailey.

In the last years of the fourteenth century, from 1396 to 1399, the now largely obsolete castle underwent a series of modifications to convert it into a comfortable and safe residence for royal use — one of several that Richard II caused to be improved. As part of this project, the landgate was substantially remodelled, the upper storey being completely rebuilt. Most of the activity of this period was naturally lavished on the buildings of the inner bailey: the excavation in the south-west quarter of the outer bailey showed that here all trace of occupation had ceased, the gullies were filled and the land was probably cultivated, giving rise to the formation of a mixed soil level which continued to develop into the middle of the fifteenth century.

After 1399 the castle was virtually abandoned, both as a strategic position and as a royal residence. Although the installations were maintained by a series of resident Constables, the gates and walls show no signs of further repair, until the late eighteenth century. The south-west quarter of the outer bailey was allowed to grass over and eventually developed a thick stone-free turf. Only the east-west boundary ditch (or at least part of it) was cleared out from time to time, possibly to maintain a functional boundary to prevent animals straying on to the road. This state of affairs continued into the second decade of the sixteenth century. The only evidence of fifteenth-century construction work comes from the watergate, where a small masonry structure of unknown function was inserted into the ruins of the earlier medieval building on the north side of the gatehouse.

In the 1520s some attempt was made to utilize the old castle as a naval store depot. In the outer bailey the ends of the boundary ditch were filled in with rubbish, probably derived from the castle, and a massive stone-built storehouse was constructed. It lasted for only a short time and was demolished by the 1580s, after which the site was left derelict once more.

The later development of the priory buildings remains obscure. Indeed, it is not certain that the conventual buildings were ever completed, but structures adjacent to the south wall of the fort remained in use until the early sixteenth century. It may be that a small monastic cell occupied the site until the Dissolution. The removal of the remaining ancillary buildings was probably carried out by the Constable, Sir Thomas Cornwallis, at the beginning of the seventeenth century at the time of his restoration of the church. Cornwallis was also responsible for making minor improvements to the landgate.

The development history of the castle defences and the outer bailey, or more strictly those parts of it which have been excavated, has now been briefly summarized. While it cannot be fully understood without a knowledge of the history of the castle, a clear differentiation can be made between the functions of the inner and outer baileys — a fact which gives some added validity to the division made in this series of reports between Volumes III and IV. The conclusion which must be reached is that throughout the medieval period large areas of the outer bailey remained unoccupied and were given over for much of the time to agricultural purposes. Such signs of occupation as there are — pits, gullies and occupation layers associated with buildings — appear to relate to sporadic use at a low social level.

When comparable material becomes available from the inner bailey excavations, interesting comparisons will be possible.

Little has been said of the village except to draw attention to its early pretensions and to the potential effect that the expanding castle defences may have had on its topography. Further detailed work on this problem is likely to be of considerable interest but must now await a future publication.

APPENDIX: COMMENTARY ON THE SECTIONS

A SELECTION of the main section drawings are presented here as figs. 122-32. The position of the landgate sections, fig. 122, will be found on the plan, fig. 8; those illustrating the watergate, fig. 123, appear on fig. 4. The cuttings across the Outer Earthwork and the fort ditches, figs. 130-2, are shown on fig. 2. The positions of the rest of the sections, figs. 124-9, are indicated on the plan, fig. 121.

In the following brief commentary only medieval layers are referred to, since the Roman and Saxon aspects of the sections have been dealt with previously (Vol. I, pp. 432-6; Vol. II, pp. 305-9).

Section 1 (fig. 122)

The top of layer 2 and the levelled top of the Roman gate wall represent the early medieval ground surface. Redeposited brickearth, trench 1, layer 3, was deposited in the late eleventh or early twelfth century as part of the levelling of the area when the landgate was built.

Section 2 (fig. 122)

The Roman gate wall was robbed in the early medieval period, the robber trench being partially levelled with rubble, layers 9 and 10, upon which a layer of silty soil accumulated, layer 8. The Norman chalk footings were taken partly on to and partly through this rubble. Subsequent layers, 7-3, represent medieval mortar and soil accumulations.

Section 3 (fig. 122)

The medieval ground level is approximately equivalent to layer 2.

Section 4 (fig. 123)

The level contemporary with the construction of the watergate is layer 11. Above this some soil accumulated (layer 10) before the mortar spread (layer 7) contemporary with the wall of building M1 was laid. To the south of the wall was an accumulation of rubble (layer 25) cut away by a later disturbance. Within the building a thin layer of soil (layer 6) accumulated on the mortar floor. This was followed by mortary rubble (layer 5) representing the collapse of the building. Layers 4 and 2 relate to subsequent late medieval occupation associated with the later building phase.

Section 5 (fig. 123)

The building level relating to the wall of building M1 is represented by trench 38, layer 4; trench 34, layer 9; and trench 33, layer 15. Soil accumulation (trench 33, layer 5) on the floor was limited in extent but then followed disuse, during which time mortary soil and rubble accumulated (trench 34, layer 8; trench 33, layer 4). Trench 33, layers 3 and 2, and trench 34, layer 2, relate to later medieval use.

Section 6 (fig. 123)

The wall of building M1 is shown with its stone and mortar sill supporting a superstructure of flints set in clay. Building spreads are represented by layer 7. To the west, soil (layers 35 and 42) accumulated before a bedding of clay (layer 34), topped by a lens of mortar (layer 9), was deposited. Then followed rubble accumulation (layers 8 and 2). To the east of the wall mortary rubble (layer 5) piled up on the mortar spread which served as the floor. Layer 4 and layer 2 relate to the late medieval occupation.

Section 7 (fig. 124)

Trench 87, layer 5, and trench 91, layer 28, represent soil accumulation from the eleventh to the thirteenth century. Mixed grey soil of later medieval and early post-medieval date is denoted by trench 87, layer 3, and trench 91, layer 3. Pits 128 and 127 are medieval. Pit 126 relates to the structure of building M2, the ground level of which is represented by the interface between trench 87, layers 3 and 5.

Section 8 (fig. 124)

The soil accumulation of the eleventh to thirteenth century is represented by trench 87, layer 5; trench 91, layer 28; and trench 107, layer 9. The fourteenth-century ground level appears on the interface between trench 87, layers 3 and 5, and trench 91, layers 23 and 28, and as trench 107, layers 32 and 23. Late medieval and early post-medieval soil layers include trench 87, layer 3; trench 91, layer 23; and trench 107, layer 4.

Section 9 (fig. 124)

The soil accumulation of the eleventh to thirteenth century can be traced as trench 100, layer 65; 101, layer 85; and 103, layer 11. The medieval ground surface dating to the late thirteenth or early fourteenth century is represented by trenches 100, layer 47, and 101, layer 47, while the surface contemporary with the use of limekiln 2 appears as trench 101, layer 57, and 103, layer 114. Both surfaces run together as trench 103, layer 11a.

The late medieval soil accumulation is represented by trench 100, layers 12 and 9; 101, layer 51; and 103, layer 7. This is sealed by the fifteenth-century turf line, trench 100, layer 8; and 101, layer 12. Above the turf line the upthrow from the foundation trench of the sixteenth-century storehouse can be seen, trench 100, layers 4 and 6; 101, layers 5, 7 and 8; and 103, layer 104.

Section 10 (fig. 125)

Layers 36 and 13 represent medieval soil accumulations.

Section 11 (fig. 125)

A wide foundation trench was cut through Roman and Saxon layers to allow a blocking wall of the late eleventh or early twelfth century to be inserted in the gap left after the robbing of the Roman south postern gate. Within the trench building rubble was dropped (layers 19 and 20) and sealed by clay (layer 11) upon which mortar from the pointing of the upper part of the Norman blocking wall had been slopped. Then followed the deliberate deposition

of rubbish (layer 4) heaped up against the wall and, later, mortar and soil accumulations (layers 33 and 31).

Section 12 (fig. 125)

The floor level for building M₃ was created by terracing into the back face of the Roman wall and levelling off the top of layer 111. Layers 31 and 24 broadly represent the occupation of the building. This was followed by accumulations of rubble, layer 6 and soil layer 3, in the late medieval and early post-medieval period.

Section 13 (fig. 126)

Mixed soil containing late Saxon and medieval pottery occurs as trench 102, layers 14, 17 and 33; 101, layer 27; and 100, layers 14, 15 and 23. In trench 101 the clay layer occurs as layer 15 with the contemporary gully 37 as layer 15a. The general layer of clay spread across the area is shown as layer 16. The fifteenth-century turf line can be seen in places in trench 100 as layer 13.

Section 14 (fig. 126)

The soil accumulation dates from the eleventh to the thirteenth century and is represented by layer 5, the late thirteenth- and early fourteenth-century ground level by layer 7 and the late medieval and early post-medieval soil accumulation by layer 3.

Section 15 (fig. 127)

General medieval soil accumulations from late Saxon and in some places Roman layers are thin in this area but appear as trench 72, layer 5; 71, layer 5; 73, layer 10; and 80, layer 5. The fifteenth-century turf line occurs over much of the area, e.g. trench 72, layer 4; 71, layer 4. Several gullies cross the section. Gully 38 is trench 72, layer 40; the soakaway pit 78 with its associated gullies just impinges on the section of trench 71, while gully 9 in its latest phase of recutting is shown on the section of trench 73 with its contemporary ground surface. An earlier ground surface, of the late medieval period, probably related to an early phase of gully 9, is demonstrated by the gravel spread, trench 73, layer 9, which may possibly equate with the gravel spread to the south, trench 71, layer 4a. Pits 116 and 125 are medieval.

Section 16 (fig. 127)

The general medieval soil accumulation which merges with the Saxon and in some places Roman levels, can be seen as trench 94, layer 37a; 95, layer 61; 96, layer 25; 97, layer 12; 98, layer 30; 99, layer 56; and 109, layer 10. In some places the fifteenth-century turf line can be seen to seal it, e.g. trench 94, layer 37; 95, layer 61a; 96, layer 25a; 97, layer 10; 98, layer 14; and 99, layer 44.

Where the soil had accumulated over the hollow of pit 187 an intermediate turf line could be seen (trench 99, layer 49, dividing two soil levels (layers 45 and 56).

The cutting of an early version of gully 32 is probably represented by the pile of up-throw, trench 98, layer 14a, which must be of late medieval date. To the north of the gully a turf line had already formed by this time (trench 98, layer 30; 99, layer 49). The profile of gully 32 shown on the section is its final form dating to the very beginning of the sixteenth century.

Layer 12 in trench 109 appears to represent a consolidated surface of the sixteenth century in front of the door of the storehouse. Earlier levels had been removed almost to natural by the constant traffic to which this area was subjected.

Pit 152 is medieval.

Section 17 (fig. 128)

The soil accumulation extending from the late Saxon to early medieval period comprises layers 24, 26 and 47. The final cutting of gully 16 was followed by some silting, after which a layer of clay (layers 27 and 61) was spread across part of the area. Then followed a further soil accumulation (layers 12, 15 and 25) before the fifteenth-century turf line formed (layers 8, 13 and 17). Below the turf line was a gravelly layer (layers 9 and 18) which presumably formed as the result of the worm action which contributed to the creation of the turf line. The foundation trenches for the sixteenth-century storehouse were cut through the turf line, the spoil being spread on the surface (layer 6).

Section 18 (fig. 128)

The late Saxon to early medieval soil accumulation is represented by layers 29, 71, 81. Gully 16 was cut from above this level. A mortar spread, layer 28, marks the medieval ground surface. The gully appears to have been re-dug (pp. 149–51) from a slightly higher level, perhaps represented by the mortar spills, layer 57, and the stony lens, layer 23. After deliberate filling more soil accumulated (layer 12) and eventually a turf line formed (layer 6). The footings for the sixteenth-century store building were cut through this and the spoil spread out (layer 7) on the turf. Between the walls the stratigraphy was disturbed in the seventeenth century.

Section 19 (fig. 128)

Layer 3 represents the medieval soil accumulation from which level gullies 1 and 2 were cut.

Section 20 (fig. 128)

Gullies 1 and 2 were obliquely sectioned in trench 69. Layer 7 accumulated when the gully was open; layer 3a represents a late medieval turf line, while layer 3 was a soil accumulation, of medieval to eighteenth-century date.

Section 21 (fig. 129)

The Saxon to medieval soil accumulation was represented by layers 15, 18 and 24. Upon this a patch of cobbles occurred at one point (layer 50) before the fifteenth-century turf line formed (layers 7 and 16). The sixteenth-century footings stood a little above the turf, the ground being made up with clay and mortary rubble (layers 9, 10, 13, 14, 19 and 22) to the floor level marked by the mortar spread, layer 5.

Section 22 (fig. 129)

The Saxon to medieval soil accumulation is marked by layers 19 and 30, which were sealed by the fifteenth-century turf line, layers 12 and 14. Between the sixteenth-century wall footings the level was made up with mortary rubble, layer 9a.

Section 23 (fig. 129)

Layers 8, 11 and 12 represent a soil accumulation spanning the period from the eleventh century until a turf line (layer 6) formed in the fifteenth century. During this time gully 16 and pit 152 were cut.

Levelling, or wear caused by traffic, at the time of the construction of the sixteenth-century building, removed part of the turf between the wall footings, but the level can be traced as the interface between layers 8 and 11.

Pit 160, and layers 3, 8 and 15, are seventeenth-century.

Section 24 (fig. 129)

Mixed soil accumulation of late Saxon and medieval date is represented by layers 16, 20 and 25. A localized patch of cobbles was laid at one point before the fifteenth-century turf line formed (layer 9). Wear or deliberate levelling had removed the turf over the western part of the site. Gully 16 was cut from the level of layer 20.

Layer 12 was a demolition layer of mid sixteenth-century date relating to the removal of the storehouse.

Section 25 (fig. 129)

Late Saxon levels survived to some height in the western part of the area (e.g. layer 75) but to the east the mixed late Saxon and medieval soil accumulation was thick (layers 63 and 30). The upper part of layer 61 also contained medieval pottery. Gully 16 was re-cut at least once (pp. 149–51) but eventually silted up and was sealed by a layer of cobbles (layer 6). After this the fifteenth-century turf line formed (layers 20, 29 and 61a). Part of the turf was removed, probably at the time when the sixteenth-century storehouse was built. Spoil from the foundation trenches was spread out to the east of the building (layers 8 and 9). Between the walls the loose mortary rubble, layers 10 and 12, represented either make-up or, more likely, demolition rubble at the time when the superstructure was being dismantled in the mid sixteenth century.

Section 31 (fig. 130)

The re-cut of the inner ditch in the early medieval period entailed the widening of the already silted Roman ditch. Rubbish (layer 8) accumulated in the bottom, while silty clay washed in from the sides (layers 6 and 7). Above this black soil formed (layer 5).

Sections of the Outer Earthwork (figs. 131, 132)

The structure of the Outer Earthwork has already been described in detail (pp. 24–7) and need not be repeated here.

KEY TO POSITIONS OF TRENCHES AND SECTIONS

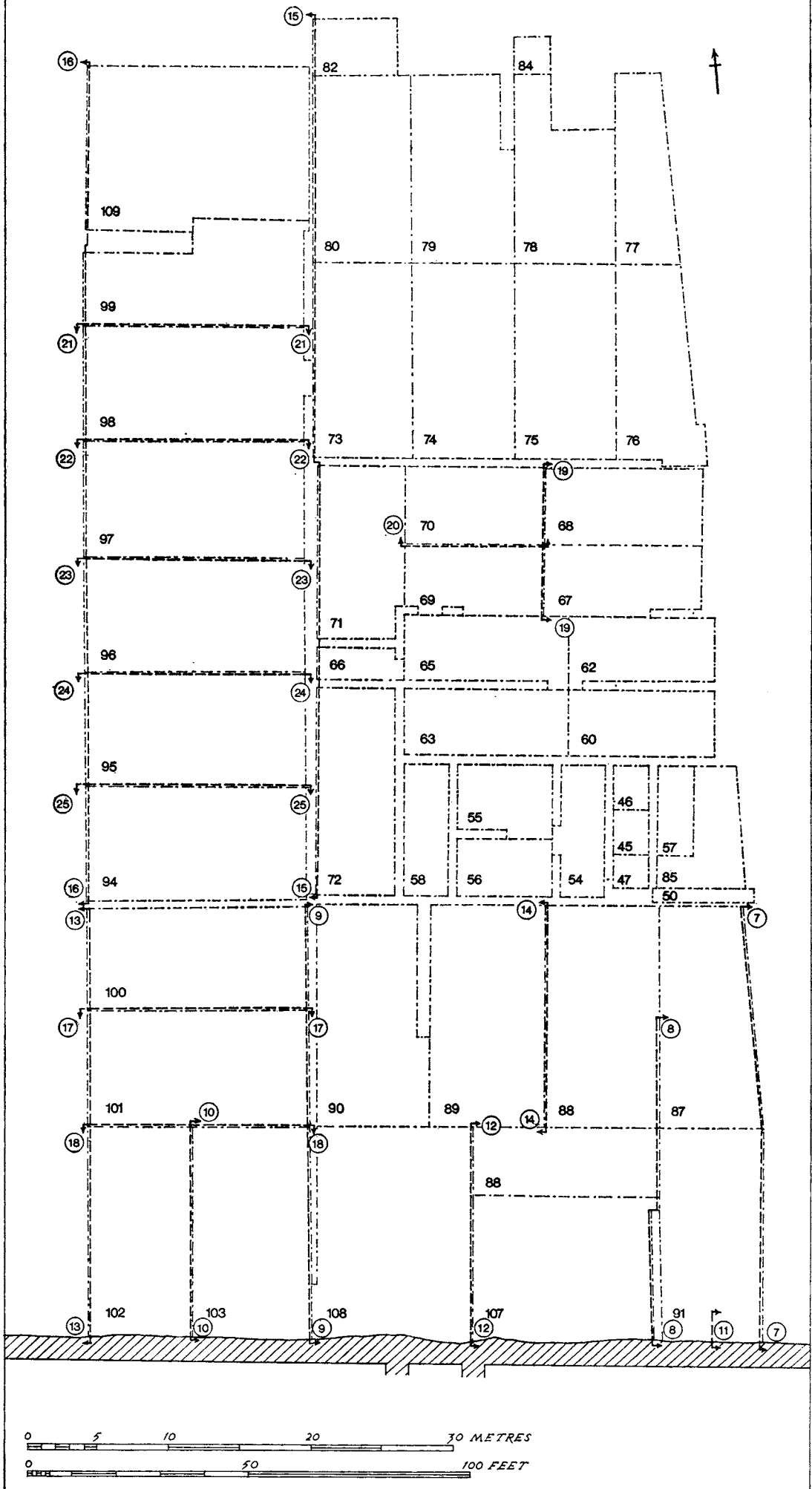

FIG. 121

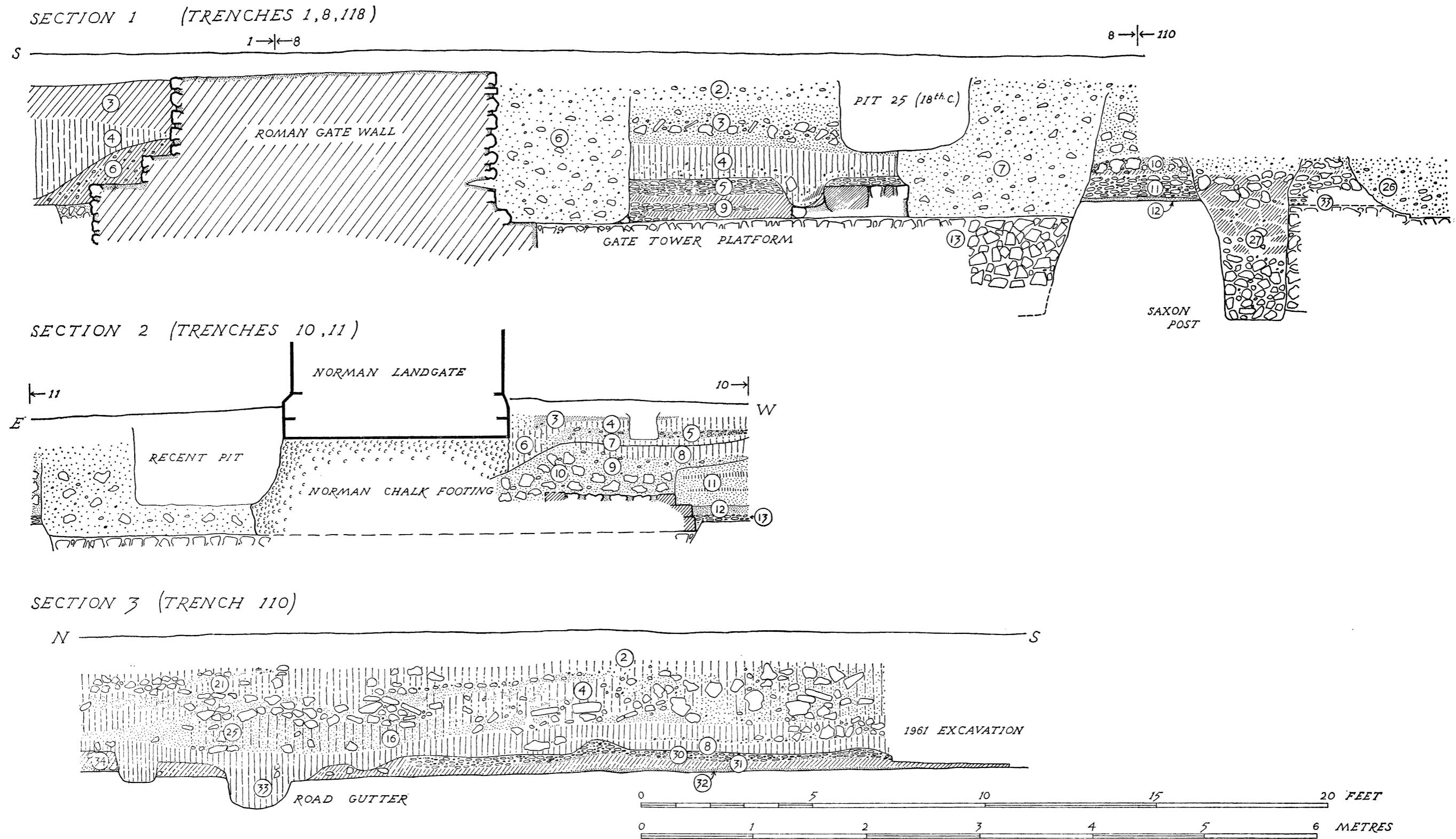
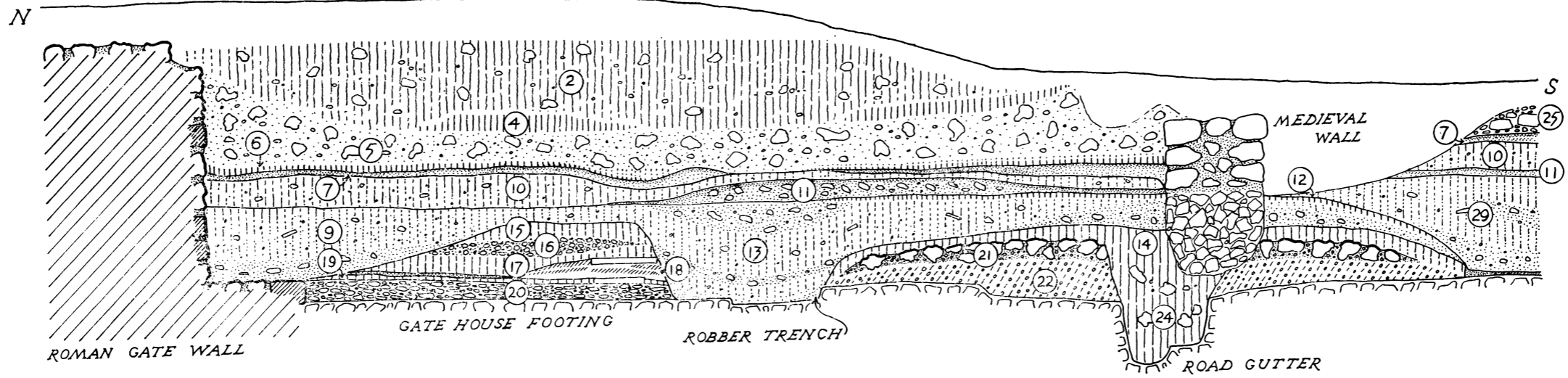
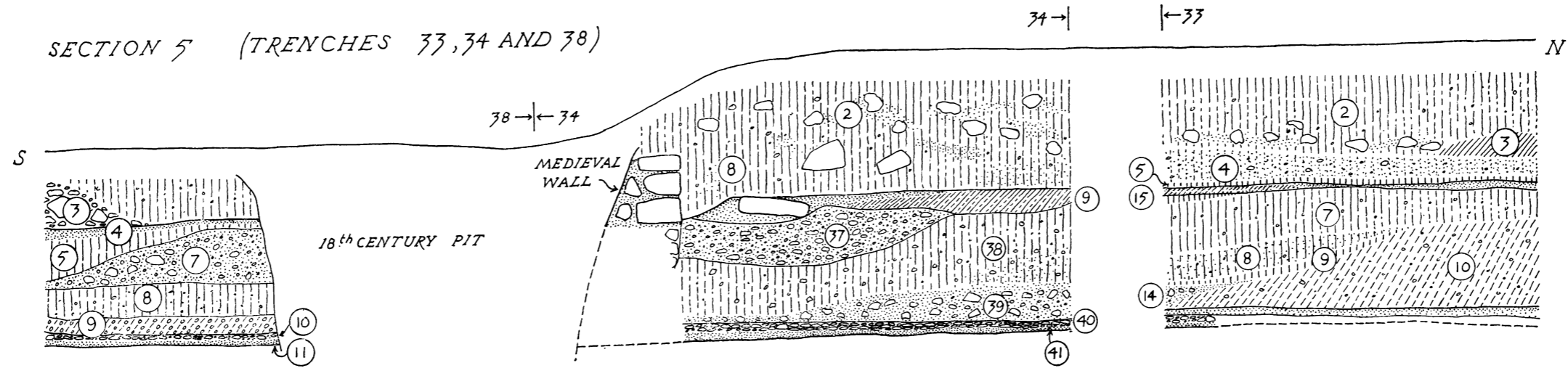

FIG. 122. Sections of the landgate

SECTION 4 (TRENCHES 32 AND 34)



SECTION 5 (TRENCHES 33, 34 AND 38)



SECTION 6 (TRENCH 34)

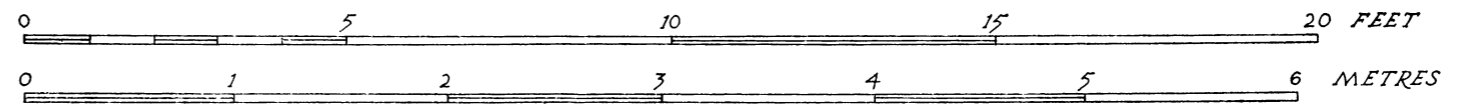
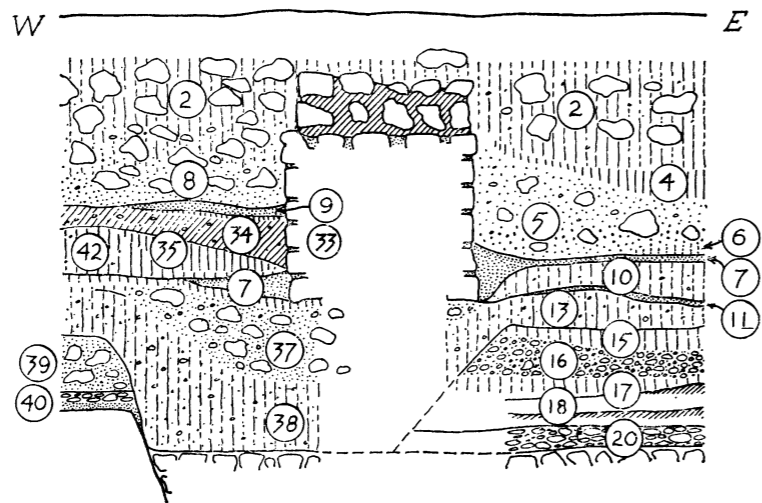
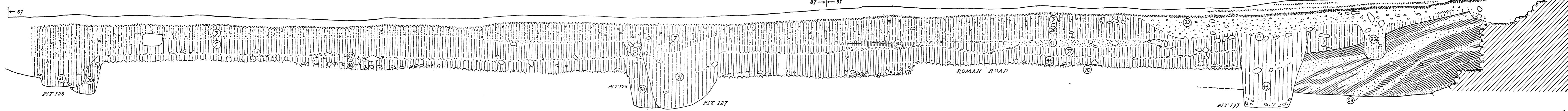
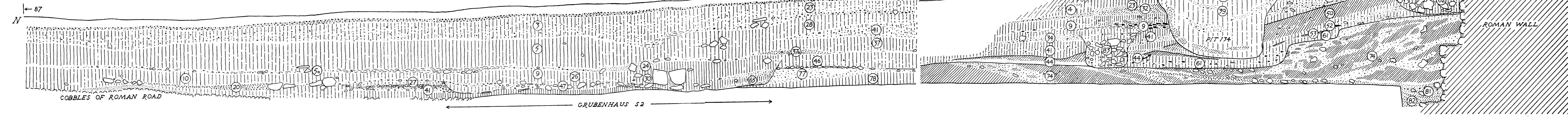

FIG. 123. Sections of the watergate

SECTION 7 (TRENCHES 87, 91)



SECTION 8 (TRENCHES 87, 91, 107)



SECTION 9 (TRENCHES 100, 101, 103)

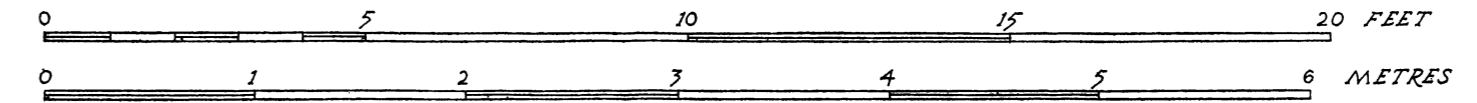
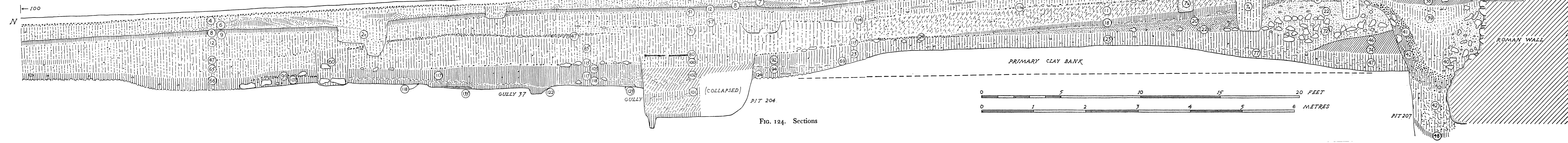
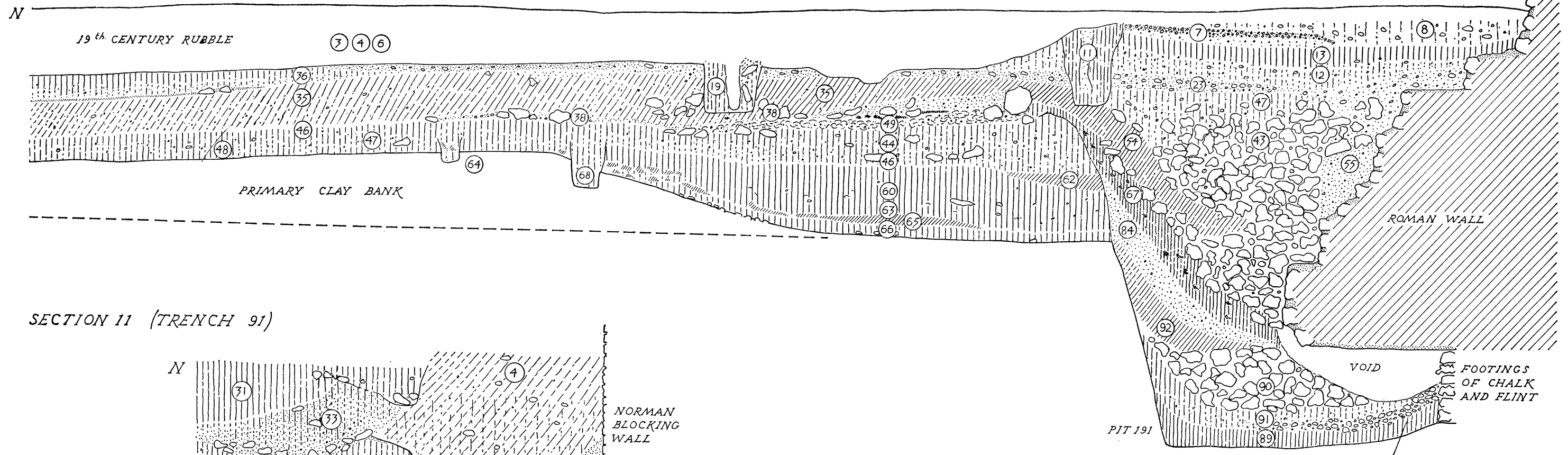
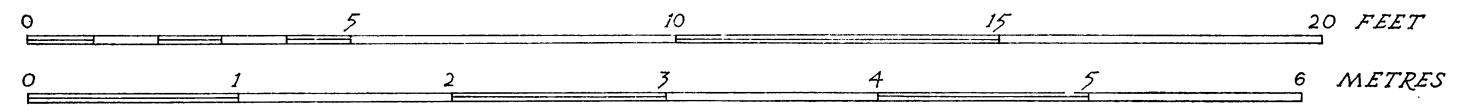
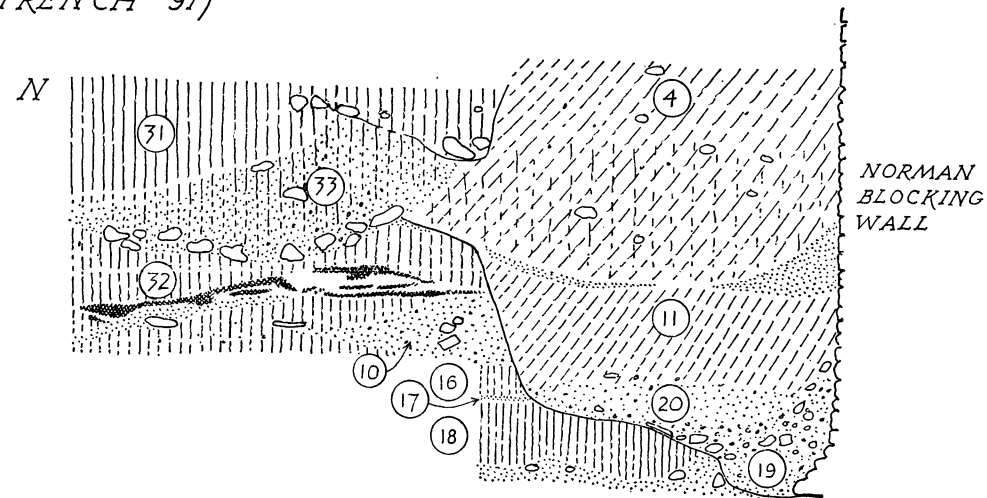

Fig. 124. Sections

SECTION 10 (TRENCH 102)



SECTION 11 (TRENCH 91)



SECTION 12 (TRENCH 108)

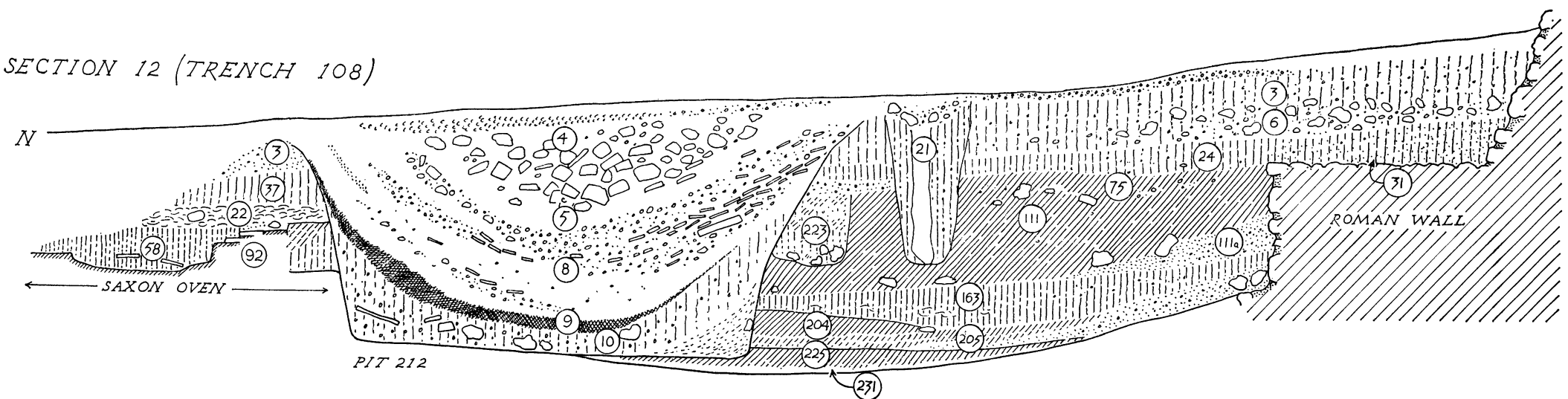

FIG. 125. Sections

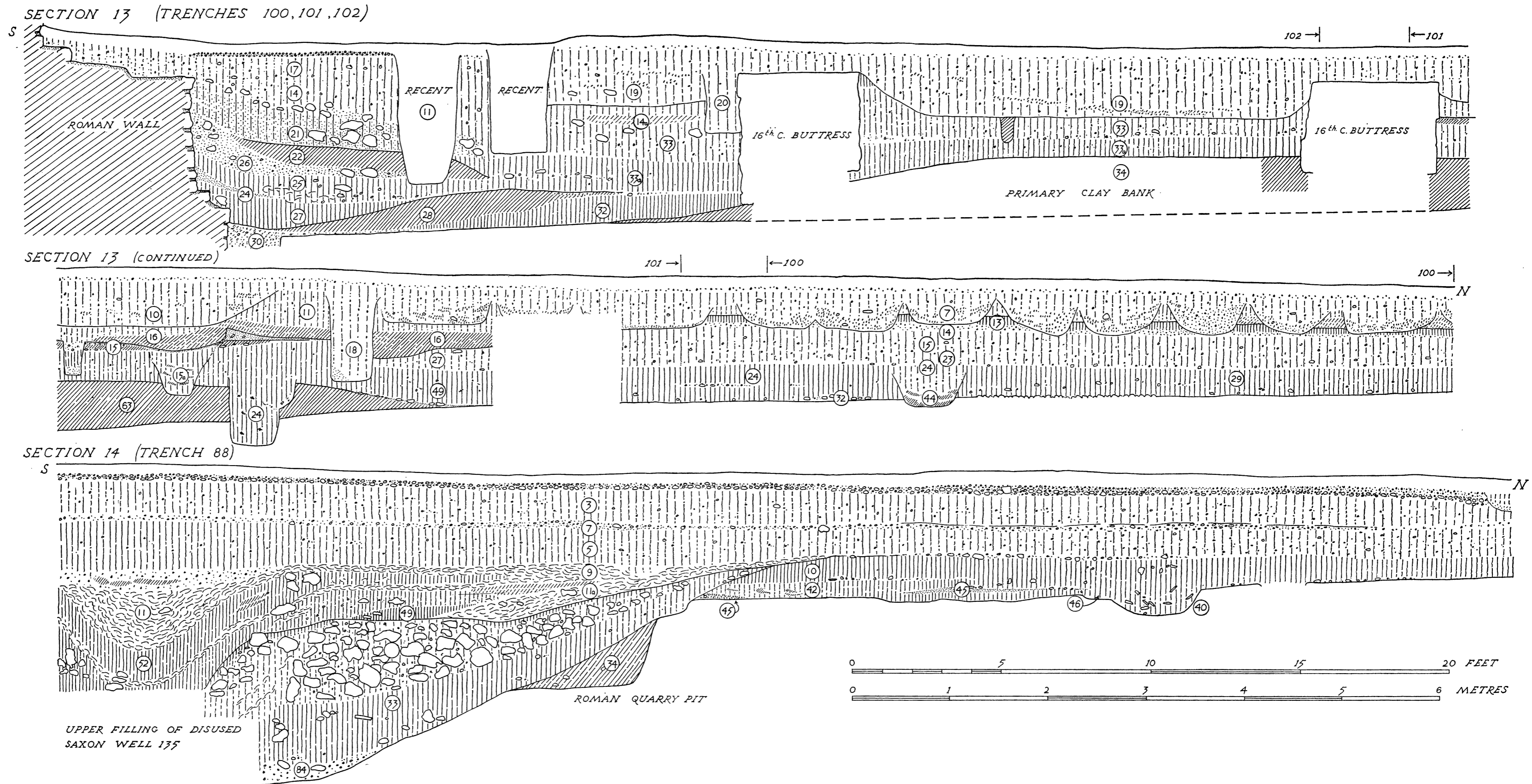
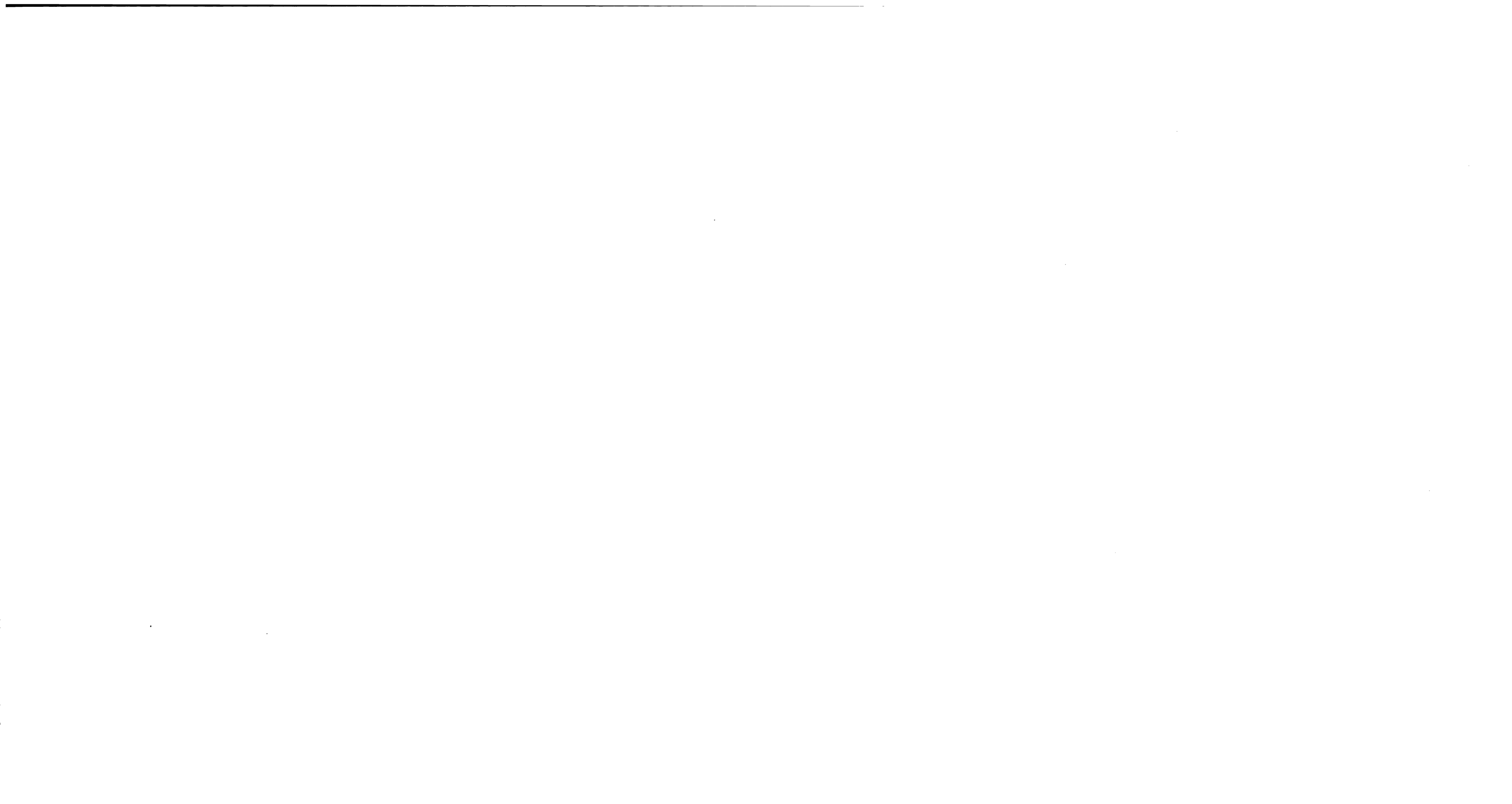
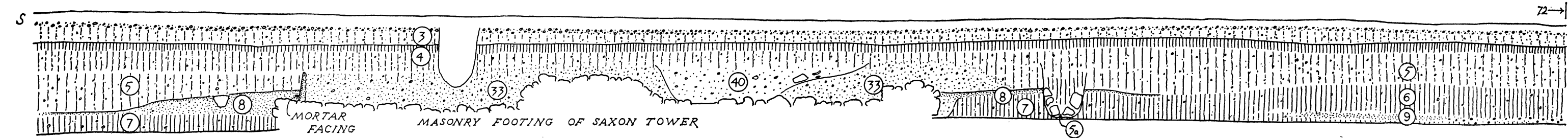

FIG. 126. Sections



SECTION 15 (TRENCHES 71, 72, 73, 80, 83)



SECTION 15 (CONTINUED)

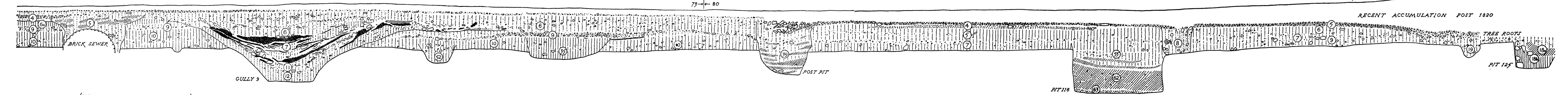

SECTION 16 (TRENCHES 94-99, 109)

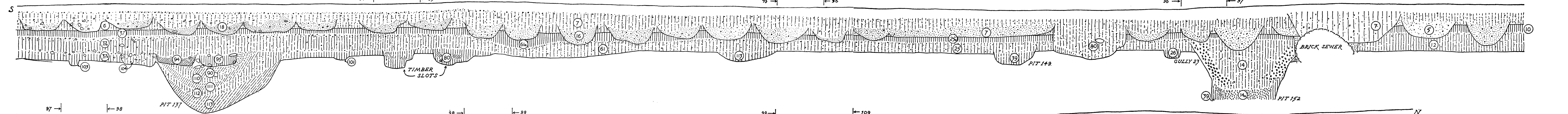

SECTION 16 (CONTINUED)

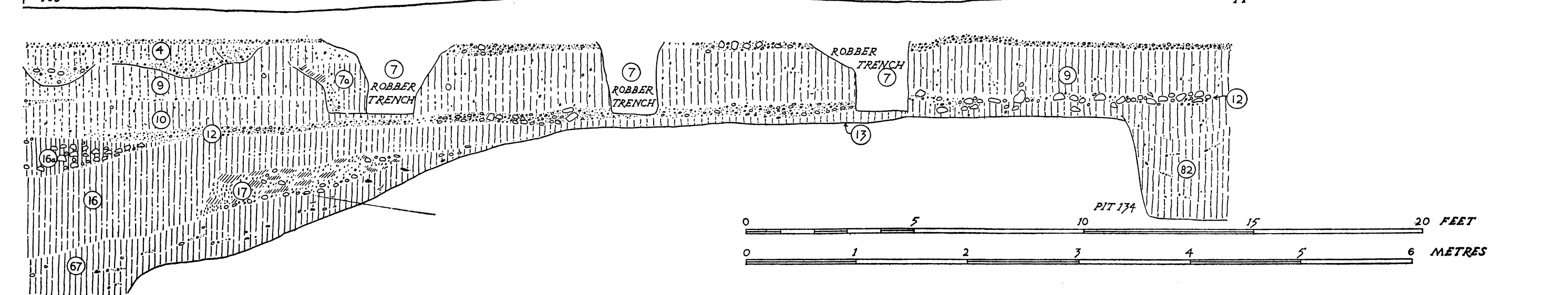
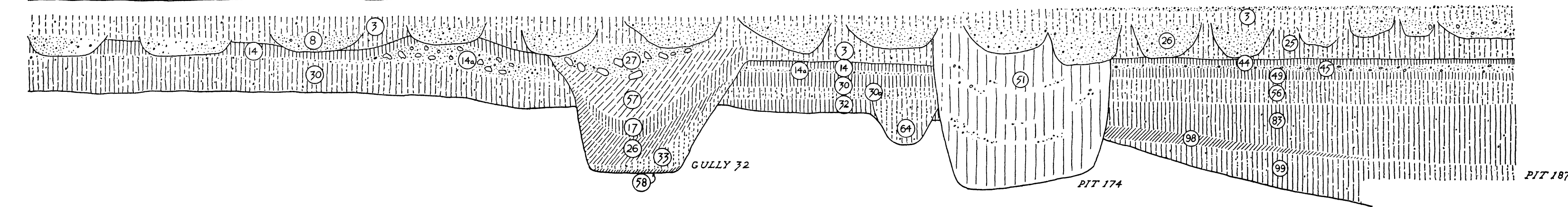
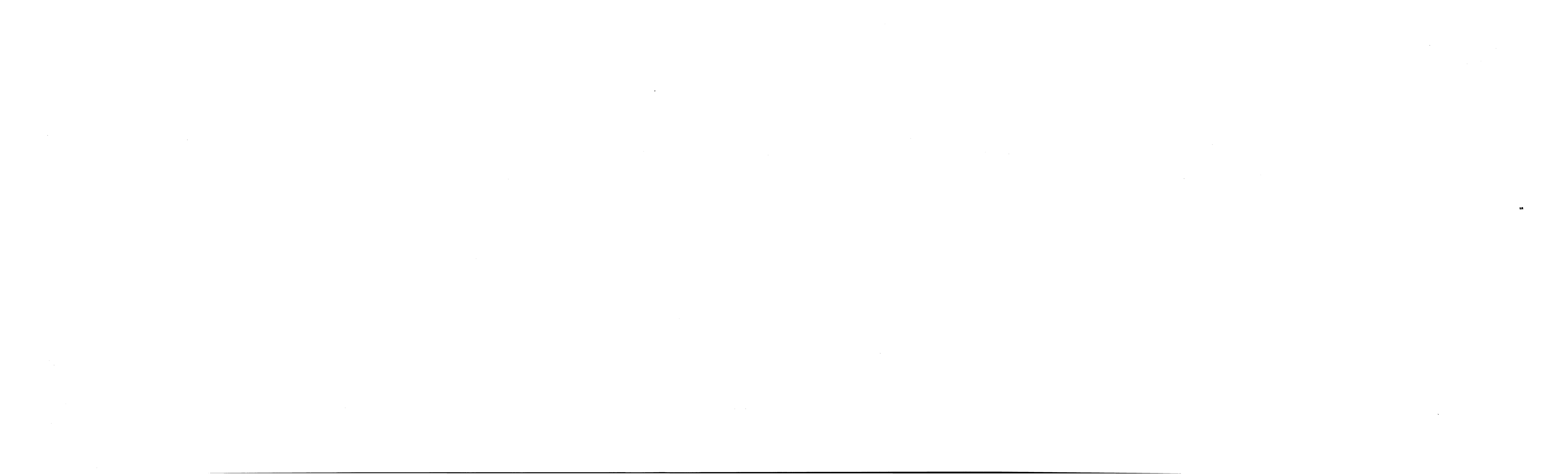
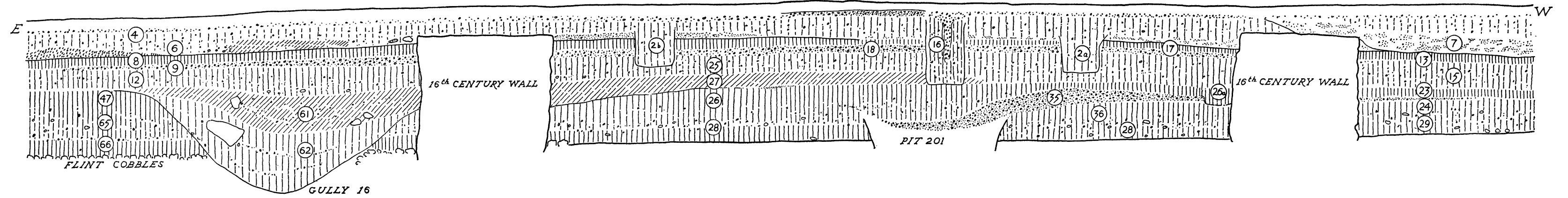

FIG. 127. Sections



SECTION 17 (TRENCH 100)



SECTION 18 (TRENCH 101)

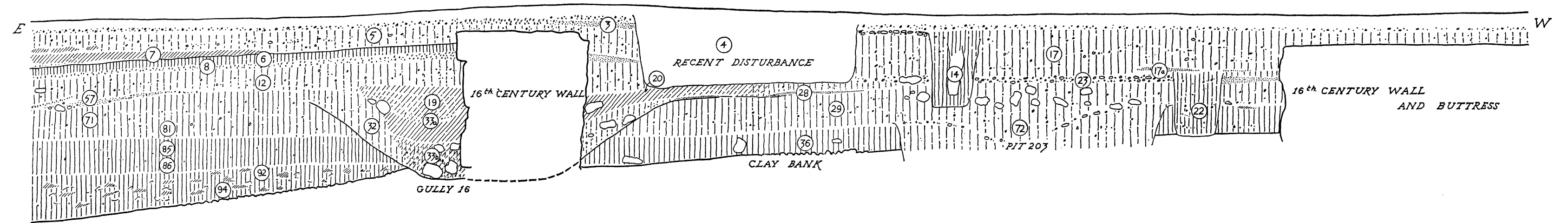

SECTION 19 (TRENCHES 69, 70)

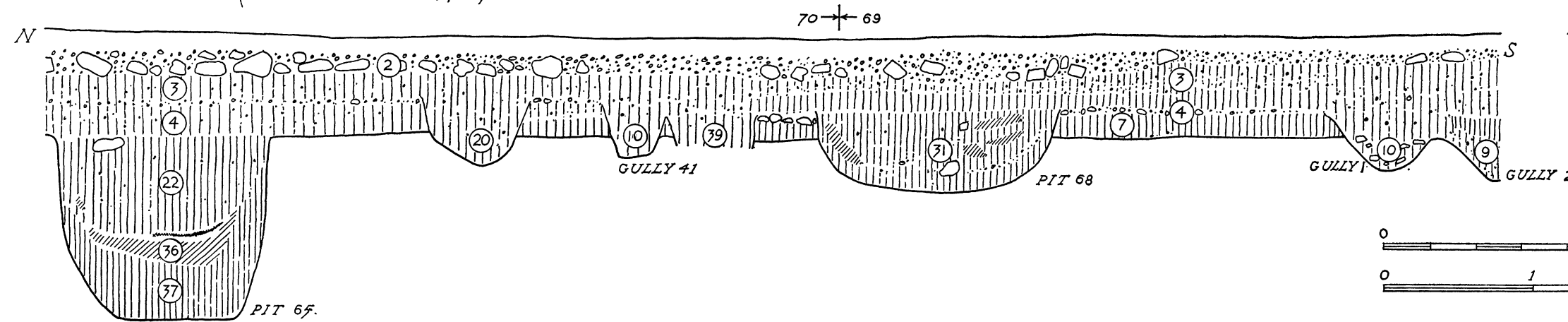

SECTION 20 (TRENCH 69)

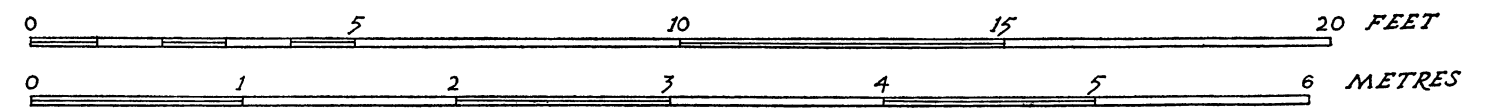
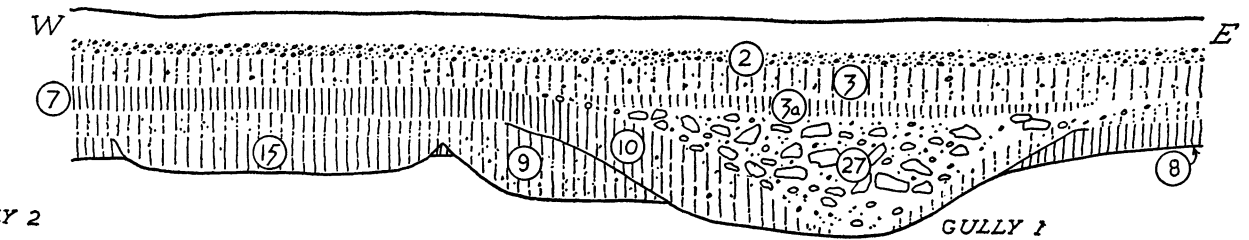

FIG. 128. Sections

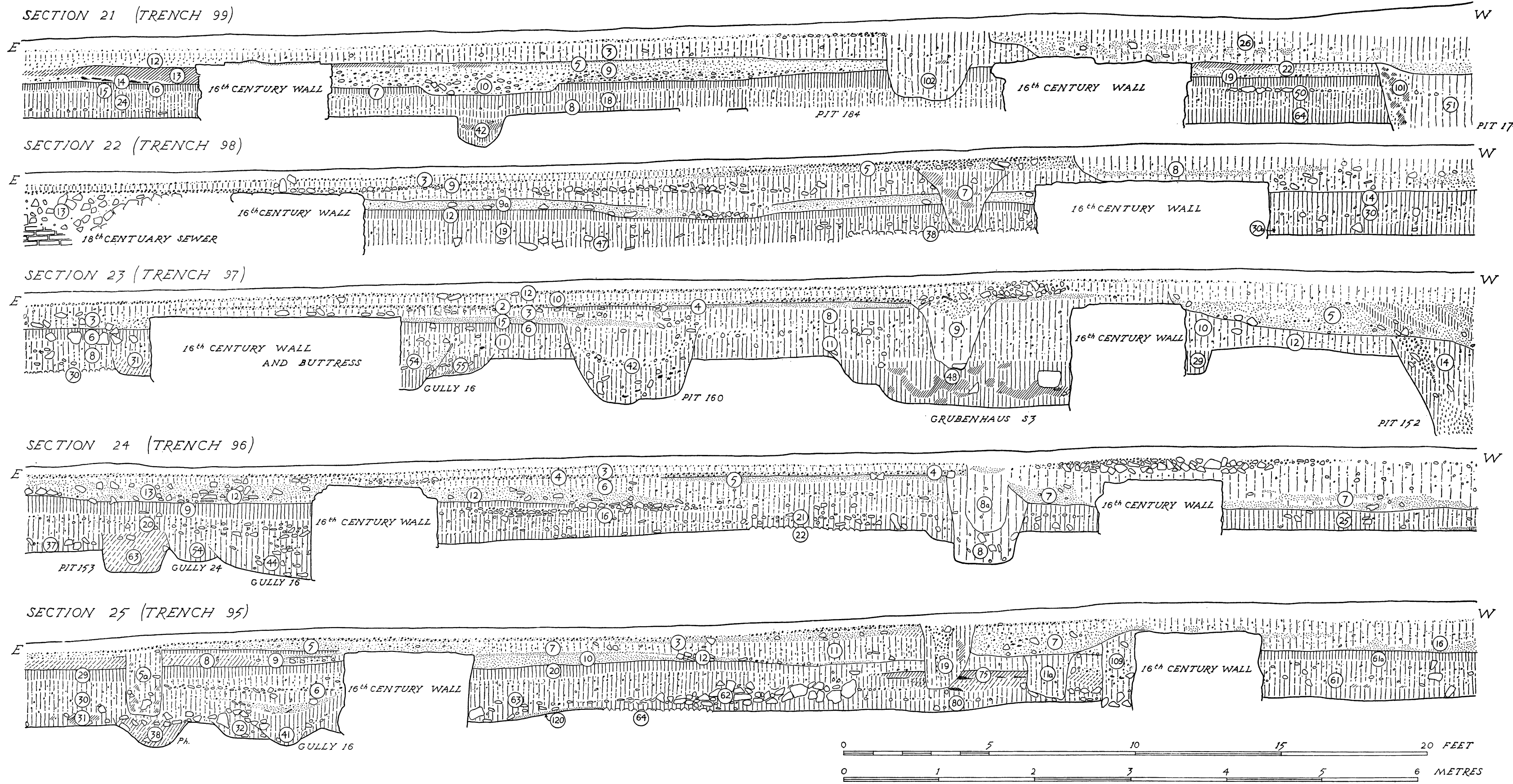

FIG. 129. Sections

1912

1913

1914

1915

1916

SECTION 15 (TRENCHES 11, 12, 13, 80, 85)

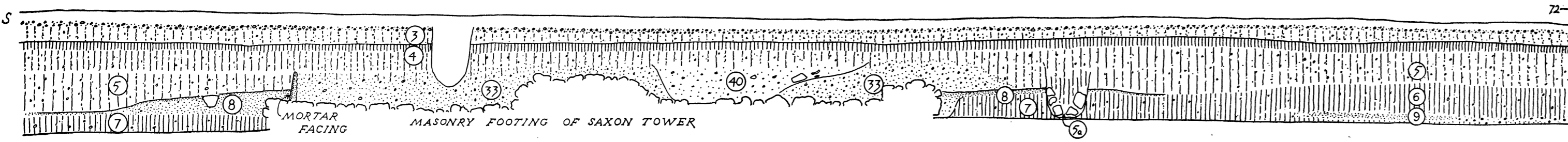

SECTION 15 (CONTINUED)

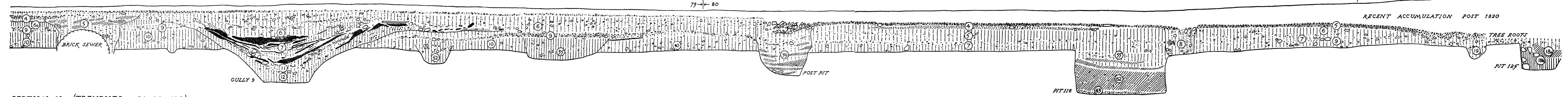

SECTION 16 (TRENCHES 94-99, 109)

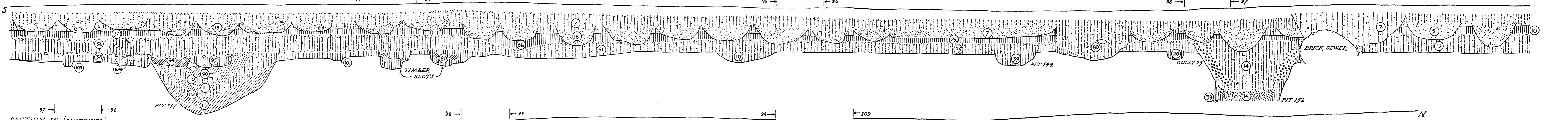

SECTION 16 (CONTINUED)

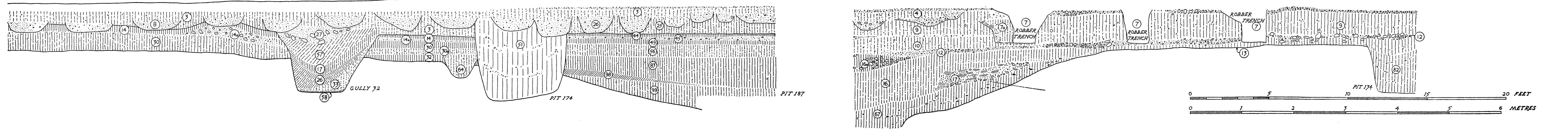

FIG. 127. Sections



SECTION 31 (TRENCHES 42 AND 43)

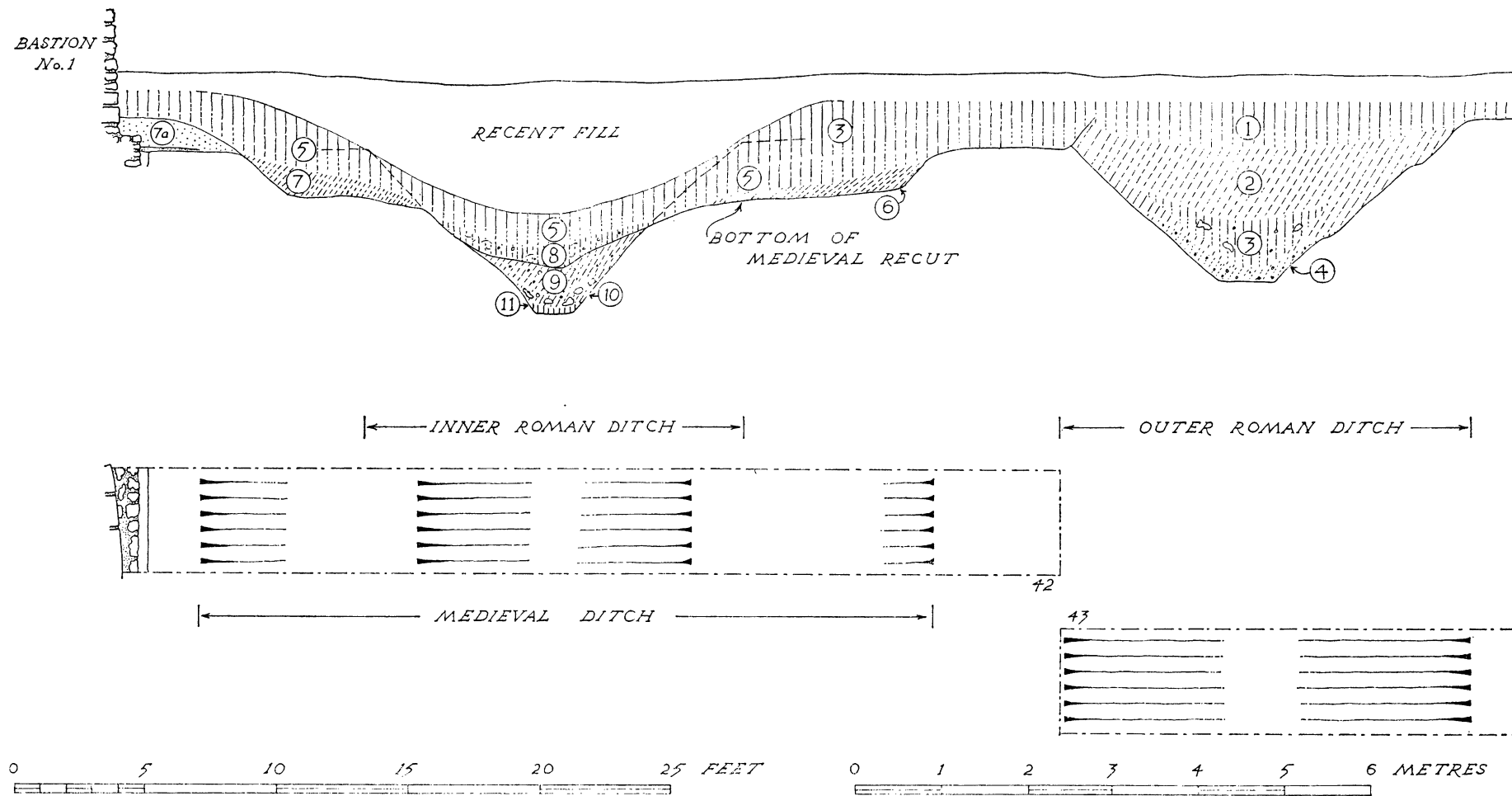

FIG. 130. Section across the Roman ditches

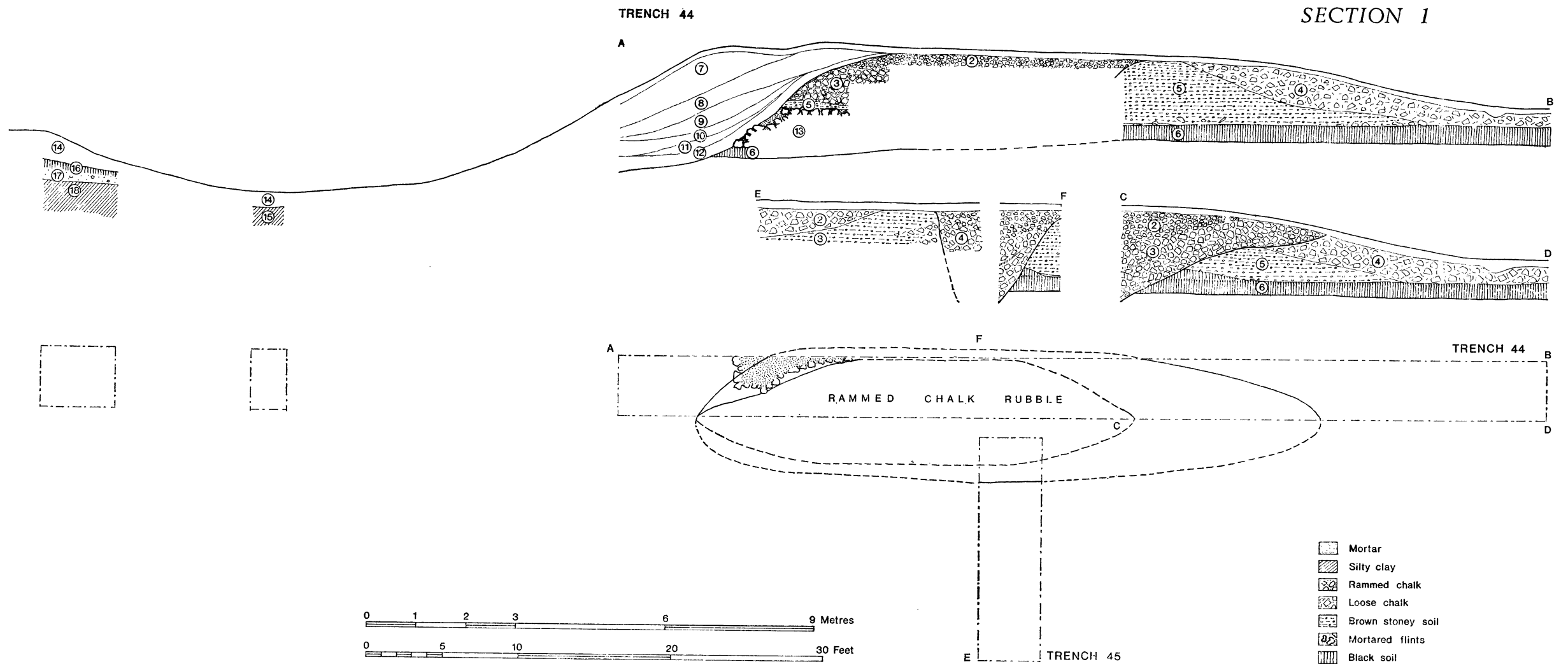

FIG. 131. Section of the outer earthwork; cutting 1

SECTION 3 TRENCH 106

OUTER EARTHWORK

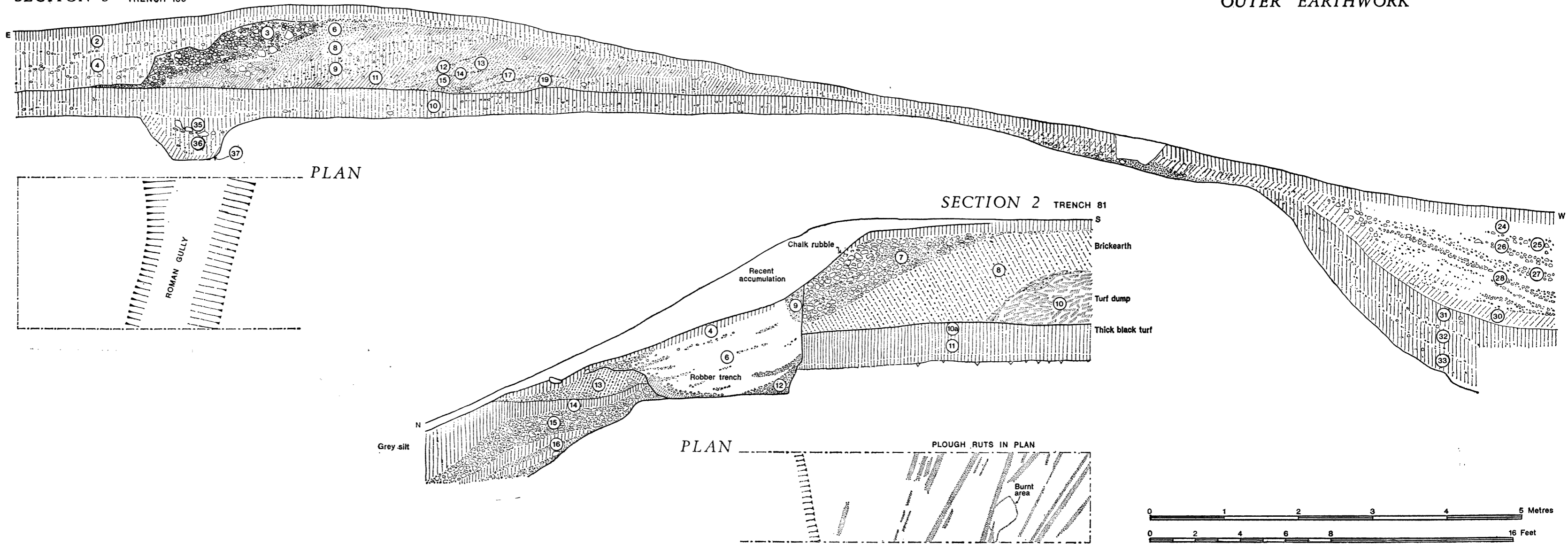

FIG. 132. Sections of the outer earthwork; cuttings 2 and 3

INDEX

- Allen, Major G. W. G., air-photography by, 42
 Alphington (Devon), font in St Michael's Church at, 114
 Andover (Hants), saw-tooth moulding in church at, 113
 Armour fragments, 194-6
 Arundel, Earl of, works by, 19
 Ash (Surrey), pottery kilns at, 189
 Augustinian canons at Portchester, 3, 4, 105, 117, 240
- Baker, D. B., on St. Mary's Church, 97-105, 115-20
 Baker, Evelyn, 97
 Barton, K. J., cited, 123, 135, 136
 Bastions, 6, 7, 8, 9, 16, 241
 Beauvais (France), jug from, 136, 137
 Bembridge (I. of Wight), limestone from, 10, 11, 42
 Binstead (I. of Wight), limestone from, 16
 Binstead (Sussex): kilns at, 136; chimney-pots made at, 123
 Bishops Waltham (Hants), 136
Boke of St Albans, cited, 234
 Bonchurch (I. of Wight), greensand probably from, 19
 Bone objects, 69, 207
 Bones:
 bird, 60, 216, 232, 233-8;
 fish, 216;
 mammal, 60, 213-33
 Borg, Dr A. C. N., on St. Mary's Church, 105-15
 Brain, C., cited, 222
 Bronze objects, 47, 51, 52, 53, 204
 Buildings:
 masonry:
 claustral, 101, 102, 104, 115;
 13th-14th century (M1), 14-16, 241;
 16th-century storehouse, 28, 31, 34, 35, 42-4, 244;
 timber:
 14th-century (M2 and M3), 31, 33, 37-42, 137, 241, 244;
 unclassified, 36, 241
 Butchery practices, 222-3
 Butley Priory (Suffolk), 118, 119
- Ceramics:
 brick, 127;
 chimney-pots, 122-4
 curfews, 189-92;
 louver, 121-2;
 tiles: floor, 127; ridge, 124-6; roof, 29, 51, 124;
 see also pottery
 Chalton (Hants), late medieval pottery from, 135, 136
 Charles I, King, Portchester sold by, 3
 Chichester (Sussex), 2, 4; kilns at, 123, 136, 137;
 chimney-pots from, 123; pottery from, 132
 Church, *see* St. Mary's Church
- Coins, 211-12
 Coldingham Priory (Berwicks.), armour rivets from, 194
 Corbels, 19, 102, 105
 Cornwallis, Sir Thomas: renovations by, 3, 21, 98, 106, 244; monument to, 106, 112, 119
 Crawford, O. G. S., cited, 42, 43
 Cresset, stone, 73, 210
- Daunce, Sir John, accounts of, 44
 Ditches, 9-10, 27
 Dormitory, monastic, 101
 Droxford (Hants), saw-tooth moulding in church at, 113
 Dudley Priory (Worcs.), 118, 119
 Dunning, Dr G. C.: on the curfews, 189-92; on the louver, 121-2; on chimney pots, cited, 123
 Dutch prisoners, housed in church, 106
- Earthwork, 24-7, 241
 Eastham, Mrs A., on the bird bones, 233-8
 Easton, Great (Essex), louver from, 121
 Edward II, King, 3
 Ewenny Priory (Glam.), 118, 119
- Farnborough Hill (Hants), pottery kilns at, 189
 Forest of Bere, 231
- Garderobe chutes, 100, 101, 120
 Gargoyles, 20
 Gates: landgate, 5, 6, 16-21, 240, 244; postern, 21-4, 240, 241; watergate, 5-6, 10-14, 240, 241, 244
 Gilyard-Bear, R., cited, 118
 Glass: lids, 210-11; window, 51, 128-30
 Grant, Mrs A., on the mammal bones, 213-33
 Gray, Sir Thomas, *see* Richard, Earl of Cambridge
 Great Easton, *see* Easton, Great
 Gullies, 43, 44, 45-56
- Hadcock, R. N., *see* Knowles, D.
 Hangleton (Sussex), curfew from, 191*n*.
 Harden, Dr D. B., on the glass lids, 210-11
 Haughmond Abbey (Salop), 118, 119
 Hawley (Hants), pottery kilns at, 189
 Hearths: lead-working, 43; 16th-century, 104
 Henry I, King, Priory founded by, 3, 105
 Henry V, King, army of, at Portchester, before Agincourt, 3
 Henry VIII, King, naval storehouse built for, 3
 Hinton, D. A.: on the bone objects, 207; on the iron objects, 196-204; on the non-ferrous metal objects, 204-7
 Hinton, D. A., and D. Peacock, on the stone objects, 207-10

- History of the King's Works, The*, 1
Hodson, J. F., cited, 117
Holling, F. W., cited, 189
Hundred Years' War, the, 3, 7, 27
Hurst, J. G., and S. Moorhouse, on the post-medieval pottery, 180-8
Hurstbourne Tarrant (Hants), saw-tooth moulding in church at, 113
Hyde Abbey, *see* Winchester
- Iron objects, 51, 52-3, 64, 69, 73, 85, 88, 90, 93, 94, 196-204
- Jewell, P. A., cited, 228
Jones, F. Elmore, cited, 211
- King, William, of Chichester, tiles provided by, 29, 124, 137
Kirkham Priory (Yorks.), 118, 119
Kirkstall Abbey (Yorks.), animal bones from, 228, 231
Knighton (I. of Wight), pottery kilns at, 137
Knollys, Sir F., 4
Knowles, D., and R. N. Hadcock, cited, 117
- Lacock (Wilts.), louver from Nash Hill kilns, 121
Lanercost Priory (Cumbria), 117, 118
Latrine, stone, 102
Laverstock, nr. Salisbury (Wilts.), kilns at, 136; curfew from 189, 191*n*.
Lead: ampulla, 207; roofing, 10, 11, 18; window, 51, 52, 128; *see also* Hearths
le Fauketer, John, 5, 10, 18
Leonard Stanley Priory (Glos.), 117, 118, 119
Lewis, Miss E., 196
Limekilns, 31, 56-60, 83, 241
Lisle, Lord, storehouse built by, 44
Llanthony Priory (Gwent), 118, 119
Luttman, Thomas, wall plaque to, 110
Lyveden (Northants.), possible wolf bones from, 232
- Malling, West (Kent), Abbey, 118, 119
Mangonels, 5, 9
Marks, R., on the window glass and leading, 128-30
Mauduit, William, castle assigned to, 2, 240
Meon, East (Hants), saw-tooth mouldings in church, at 113
Michelmersh (Hants), pottery from kilns at, 132
Micklethwaite, J. T., cited, 117
Mill, 28-9
Moorhouse, S.: on the Tudor Green wares, 188-9; *see also* Hurst, J. G.
More, manor of the, *see* Rickmansworth
Mortars, stone, 210
Mouldings, stone, 10, 11, 19, 20, 127-8
- Nash Hill, *see* Lacock
Nately Scures (Hants), chevron pattern on church doorway at, 114
- Netherlands, pottery from, 136, 137
Norden Survey, 28, 44
Northolt Manor (Greater London): animal bones from, 228; curfew from, 191*n*.
Norton Priory (Cheshire), 102, 116, 117, 118, 119
- Old Sarum, *see* Sarum, Old
Ostend (Belgium), curfews from Mariakerke and Raversyde, near, 190, 191
- Palschyd, Richard, captain of Portsmouth garrison, 44
Peacock, D., *see* Hinton, D. A.
Petersgate, *see* York
Petersfield (Hants), St Peter's church at, 106, 107, 113
Pevsner, Sir Nikolaus, cited, 105, 106, 111, 114
Pits, 14, 29, 34, 35, 60-95, 102, 104
Plaster, wall, 51, 128
Ploughing evidence, 30, 31, 33, 34
Portchester (Hants): historical background, 2-4, 5-7; royal residence, 3, 7; topography, 2; village, 4, 245
Portsmouth (Hants): 2, 3, 4; 16th-century storehouse at, 44
Portsmouth Polytechnic Archaeological Society, 97
Postholes: 31-2, 33, 34, 35-6, 241; *see also* Buildings, timber
Pottery: Saxo-Norman and medieval, 132-5, 138-80; post-medieval, 135-6, 137, 180-9; imported wares: medieval, 132, 135, 244; post-medieval, 136, 137, 180-8; *see also* Ceramics
Priory, 2, 3, 49, 53, 100-4, 105, 115-20; *see also* St Mary's Church
- Reading (Berks.), scroll pattern in abbey, 114
Refectory, possible site of, 104
Reredorter, 100, 101
Rhineland, pottery from, 136, 137
Richard II, King: Portchester used as residence by, 3, 7, 21, 244; building operations of, 11, 14, 19, 29
Richard, Earl of Cambridge, Henry, Lord Scrope of Masham, and Sir Thomas Gray, plotting at Portchester, 3
Rickmansworth (Herts.), louver from the manor of the More near, 121
Rigold, S. E., 97
Robinson, H. R., on the armour fragments, 194-6
Rouen (Normandy), pottery from region of, 135, 137
Ruts, wheel or sledge, 30, 35, 241
Rye (Sussex), kilns at, 136
- St Mary's Church: 28, 97, 105-20; architectural features, 107-12; decoration, 106, 108-9, 110, 111, 112-13, 114-15; doorways, 108, 109, 110, 111, 112; font, 114-15; history, 105-7; painted panel, 107; plan, 107, 118; roof, wooden, 107, 110; tower, 111
Sanson, moneyer, 212
Sarum, Old (Wilts.), concave lozenges at, 113

- Scrope, Lord, of Masham, *see* Richard, Earl of Cambridge
- Shoreham, Old (Sussex), church of St Nicolas at, 107, 114
- Slates, roof, 14, 51, 121, 126
- Slicher van Bath, B. H., cited, 227, 233
- Southampton (Hants): 2, 3, 4; chimney-pot from Chichester found at, 124; limekilns at, 60*n.*; imported wares at, 137
- Southwick (Hants), Priory moved to, 3, 105, 240
- Spain, pottery from, 136, 137
- Stamp, L. D., cited, 227
- Stephen, King, silver penny of, 211-12
- Stonar (Kent), armour rivets from, 194
- Storehouse, Tudor, 28, 31, 34, 35, 42-4, 244
- Tarring (Sussex), painted ware from, 136
- Tiles, *see under* Ceramics
- Timber: buildings, *see under* Buildings; fortification, 5; shuttering, 21, 24; voids, 102
- Towers: church, 111; Saxon, 115, 240
- Tudor Green pottery, 188-9
- Uvedale, Sir William, Portchester bought by, 3
- Vaulting, 21
- Village, *see* Portchester
- Walls, method of construction of, 7, 14, 16, 21, (church) 100, 107
- Walsingham, Our Lady of, 207
- Wattle and daub, 41
- Well, 86
- West Malling, *see* Malling, West
- Wharf, 29
- Whetstones, 64, 90, 207
- Wickham Common (Hants): kiln sites at, 136, 137; chimney-pots from, 124
- Williams-Freeman, J. P., 24
- Willmer, P. de R., 196
- Winchester (Hants): 2; curfew from, 189, 191*n.*; louver from, 121; pottery from, 132, 133; scroll pattern in Cathedral, and Hyde Abbey, 114
- Wisby, Gotland (Sweden), armour plates from, 195
- Wittering, East (Sussex), chevron and ball decoration in church at, 114
- Yaverland (I. of Wight), Church of St John the Baptist at, 113
- York (Yorks.), Petergate, animal bones from, 217, 228, 231
- Zodiac, signs of, in church, 108

PLATE I

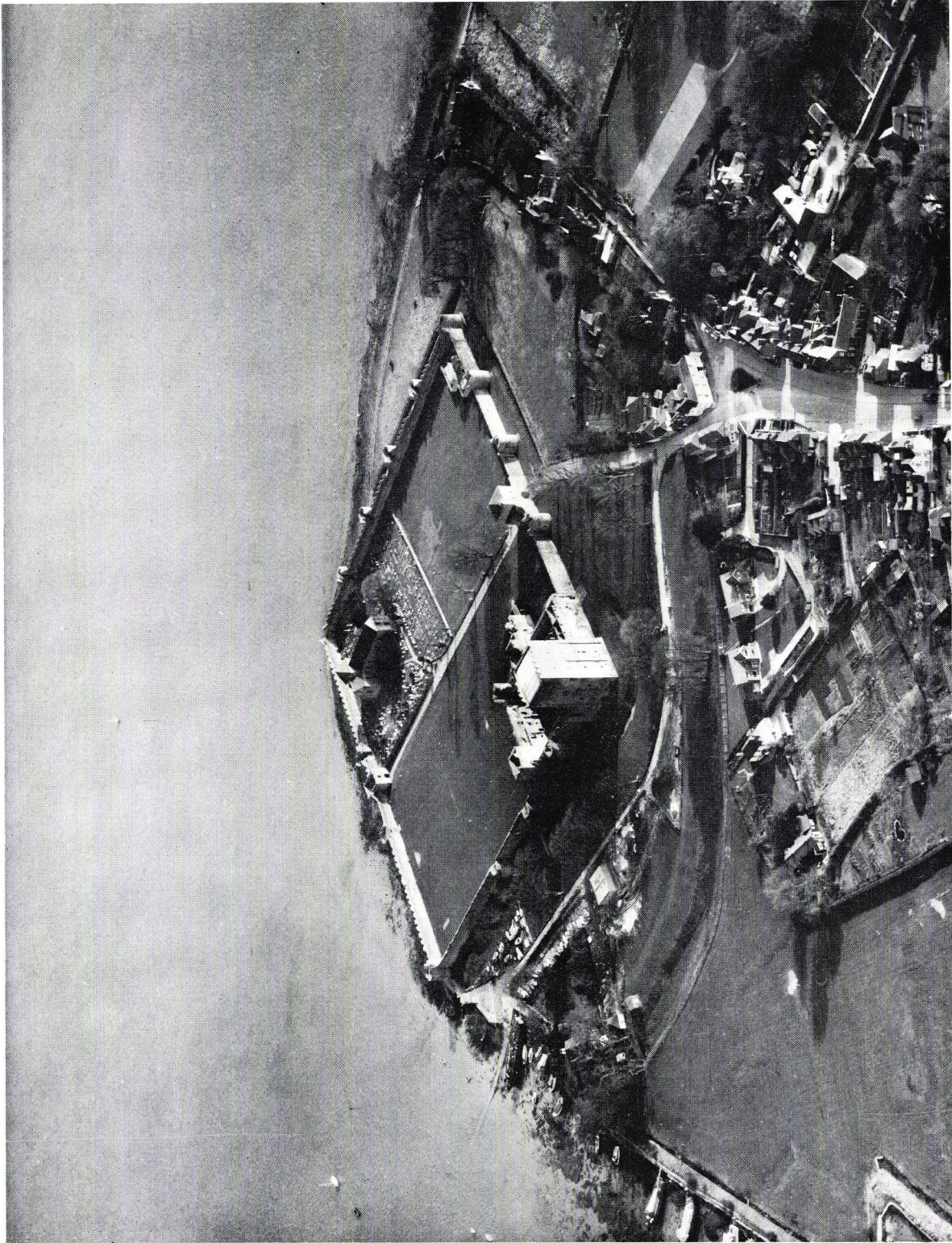

Portchester Castle and the village from the air
(photo : Aerofilms Ltd.)

PLATE II



a. The east wall of the Roman fort: the outside refaced in medieval times
(photo: David Baker)

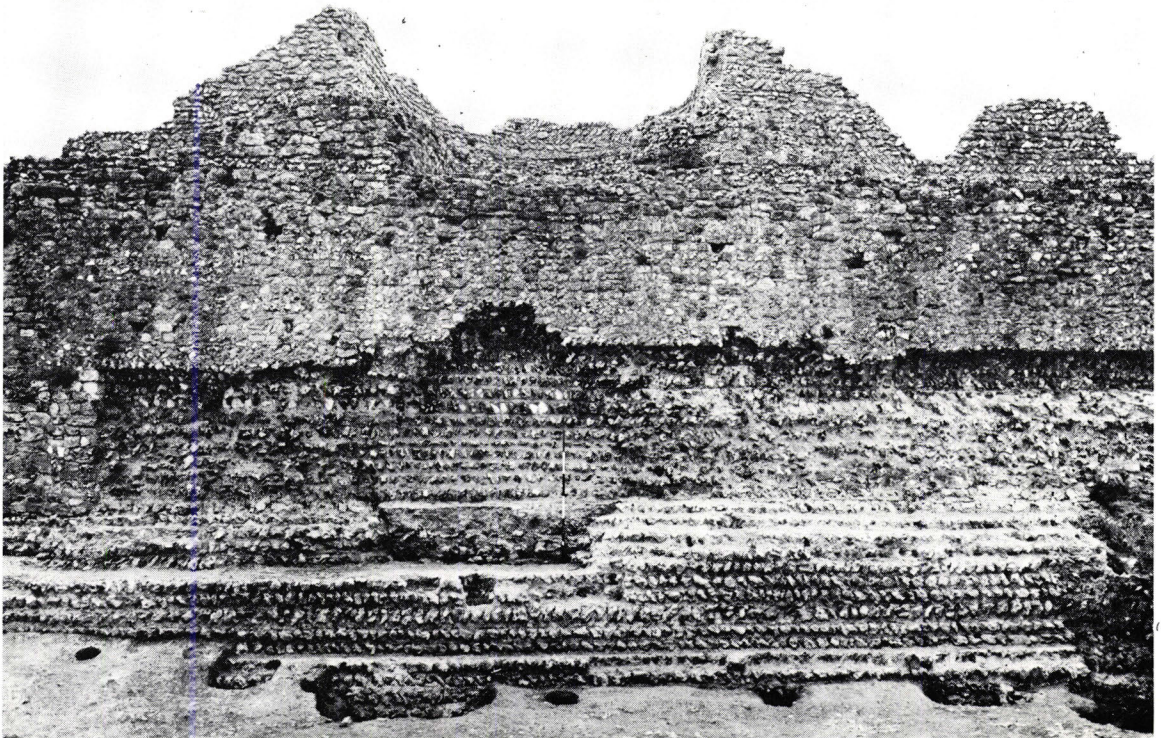

b. The south wall of the Roman fort, inner face, showing the platform cut into the Roman core for building M3
(photo: Mike Rouillard)

PLATE III

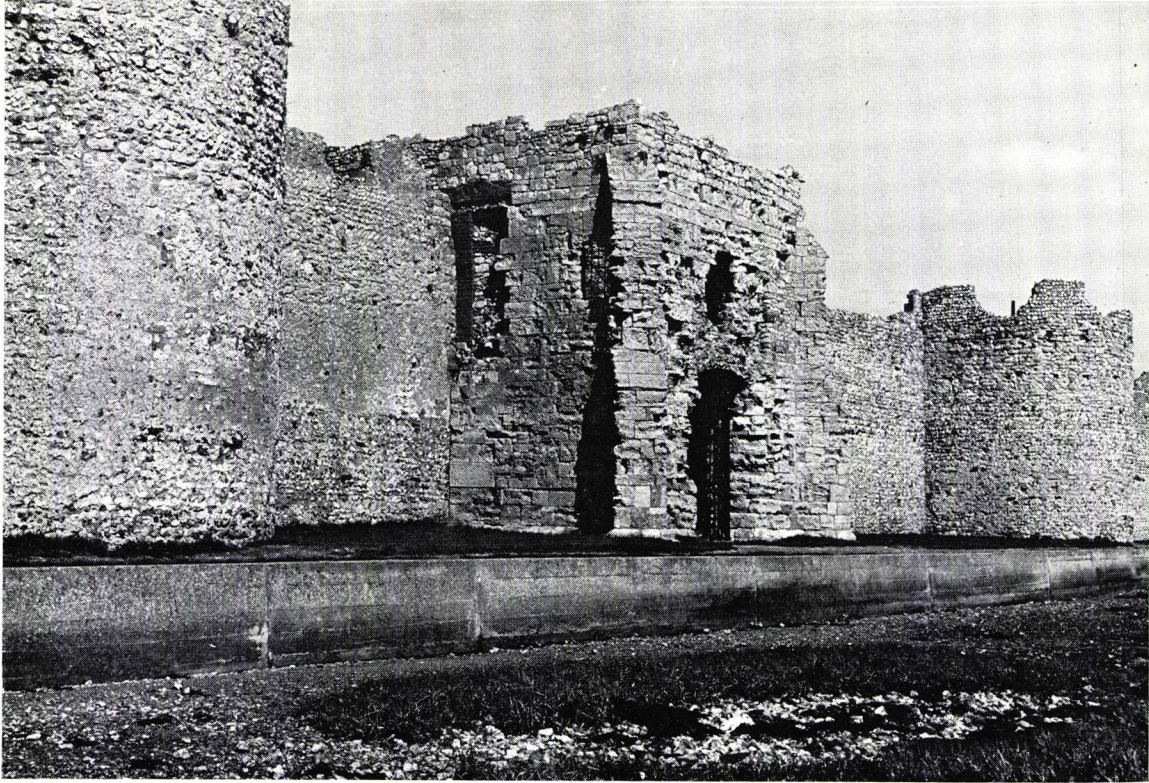

a. The watergate: the medieval outer gatehouse
(photo: David Baker)



b. The watergate: the medieval outer gatehouse
(photo: David Baker)

PLATE IV



The watergate: south side of the middle gate; fourteenth century
(photo: Mike Rouillard)

PLATE V



a. Building M1 at the Watergate
(photo: David Baker)



b. Building M1: two medieval walls and the corner of the inturned Roman wall
(photo: David Baker)

PLATE VI

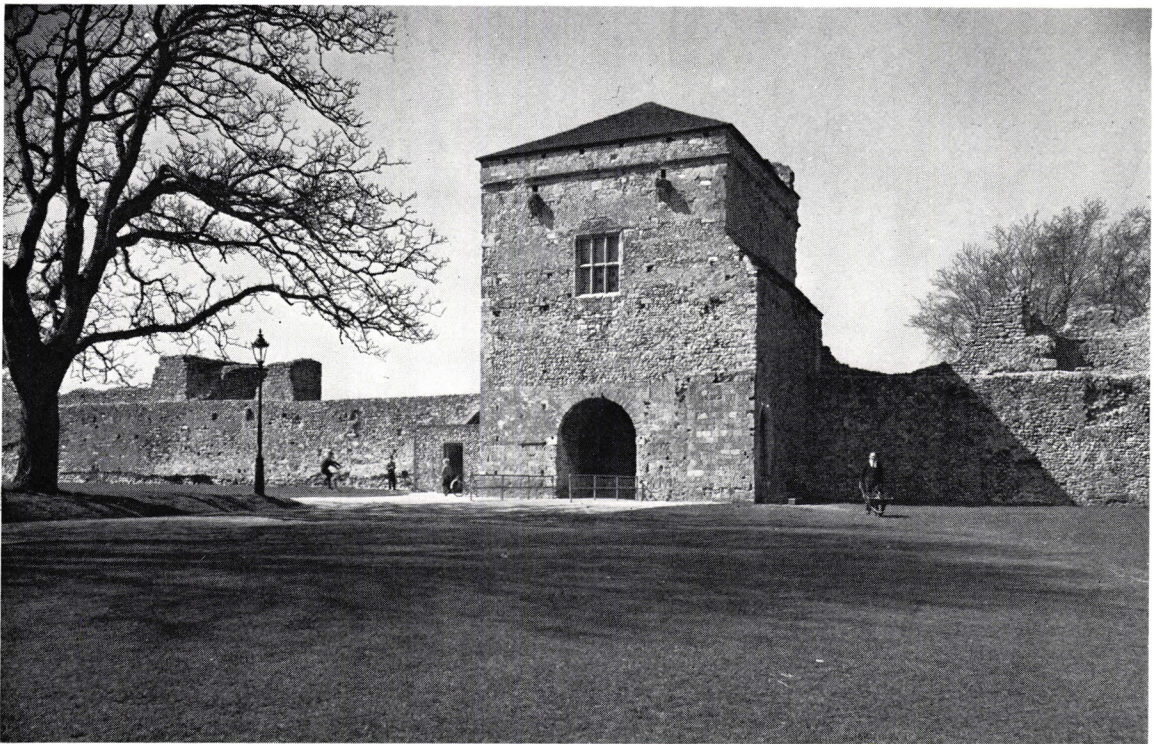

a. The landgate: the east (inner) face
(photo: David Baker)



b. The landgate: the west (outer) face
(photo: David Baker)

PLATE VII



a. The landgate during excavation. Roman gatehouse in the foreground with the unweathered face of the Norman landgate beyond
(photo: Mike Rouillard)

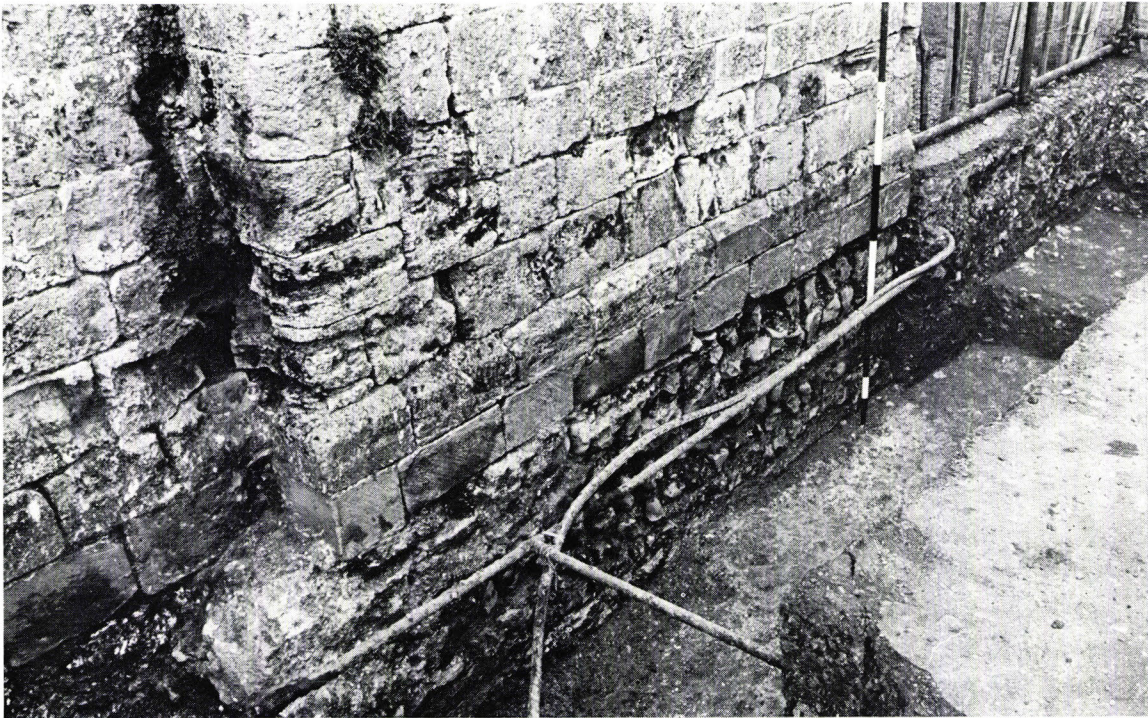

b. The landgate showing the Norman ashlar built immediately above Roman flintwork
(photo: David Baker)

PLATE VIII



a. The landgate: the outer gate
(photo: Mike Rouillard)



b. The landgate: door to stairway in
north face
(photo: Mike Rouillard)

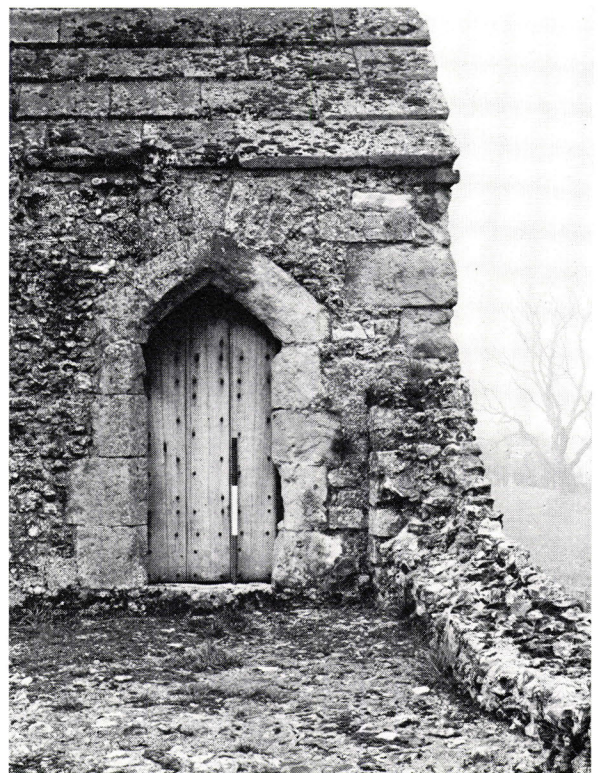

c. The landgate: door to wall-walk in
north face
(photo: Mike Rouillard)

PLATE IX



a. The landgate: upper chamber showing inside of west wall
(photo: Mike Rouillard)

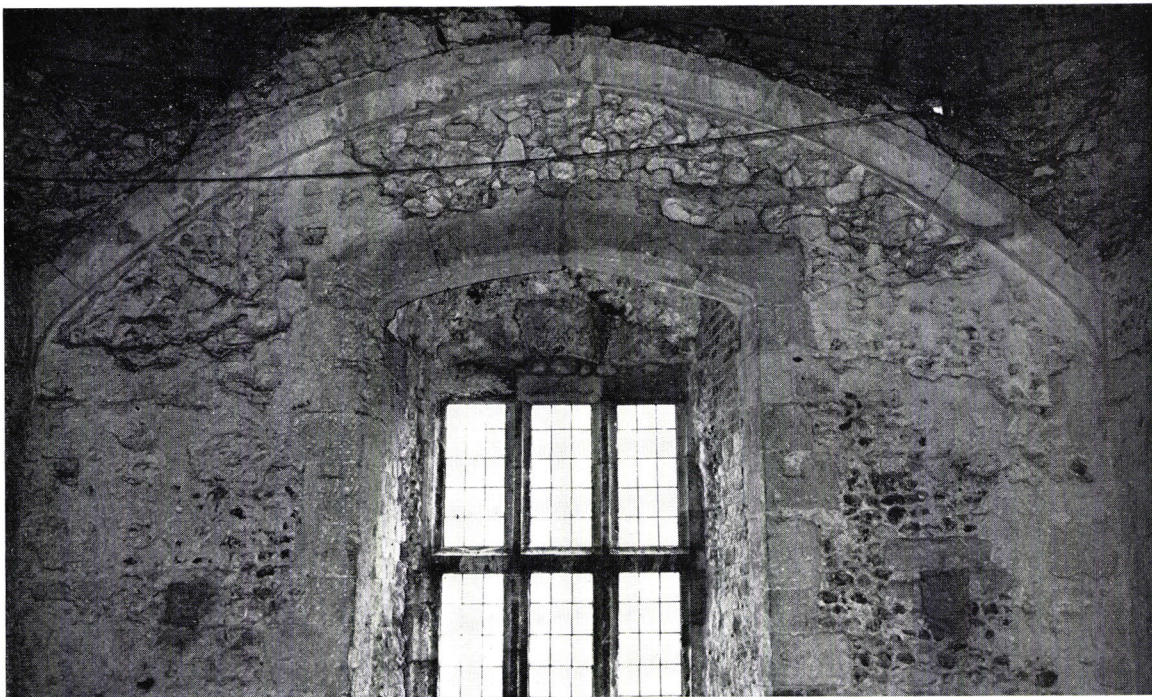

b. The landgate: upper chamber showing inside of east wall
(photo: Mike Rouillard)

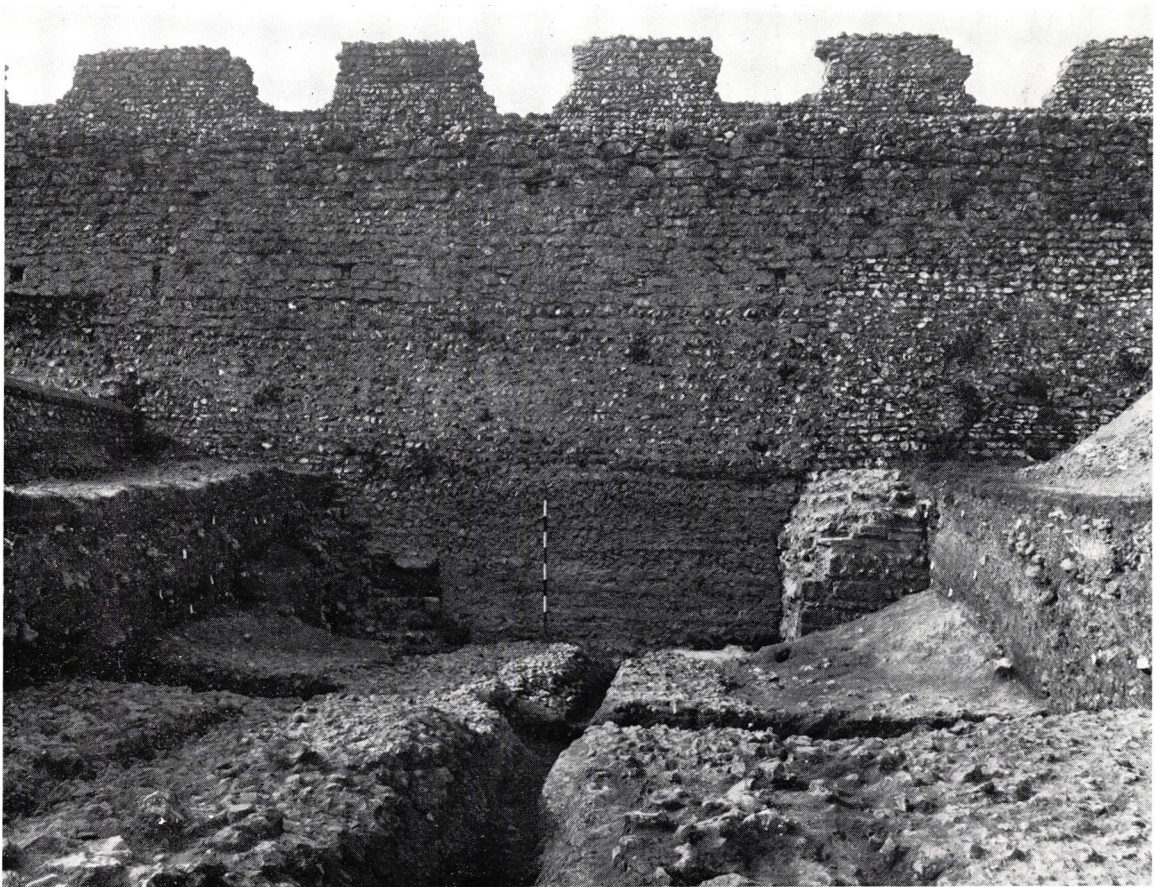

a. The Roman south postern gate blocked in the early medieval period
(photo: David Baker)



b. The medieval south postern gate, later blocked
(photo: Mike Rouillard)

PLATE XI



a. The Roman north postern gate blocked in the early medieval period and later re-opened
(photo: David Baker)



b. The outer earthwork north of the entrance road
(photo: David Baker)



a. The outer earthwork: section 1 showing rammed chalk foundation in the cross section
(photo: David Baker)



b. The outer earthwork: section 1, front face, showing the flint and mortar rubble cut by the rammed chalk foundation
(photo: David Baker)



a. The outer earthwork: section 2. Front face showing
(?) Napoleonic pit cut through the rampart
(*photo: David Baker*)



b. The outer earthwork: section 3, back face
(*photo: Mike Rouillard*)

PLATE XIV



Medieval and Roman pits immediately south of the south inturned wall of the Roman landgate
(*photo: David Baker*)

PLATE XV



a. Pit 11, cut against back face of the Roman wall: stone lined at the top
(photo: David Baker)

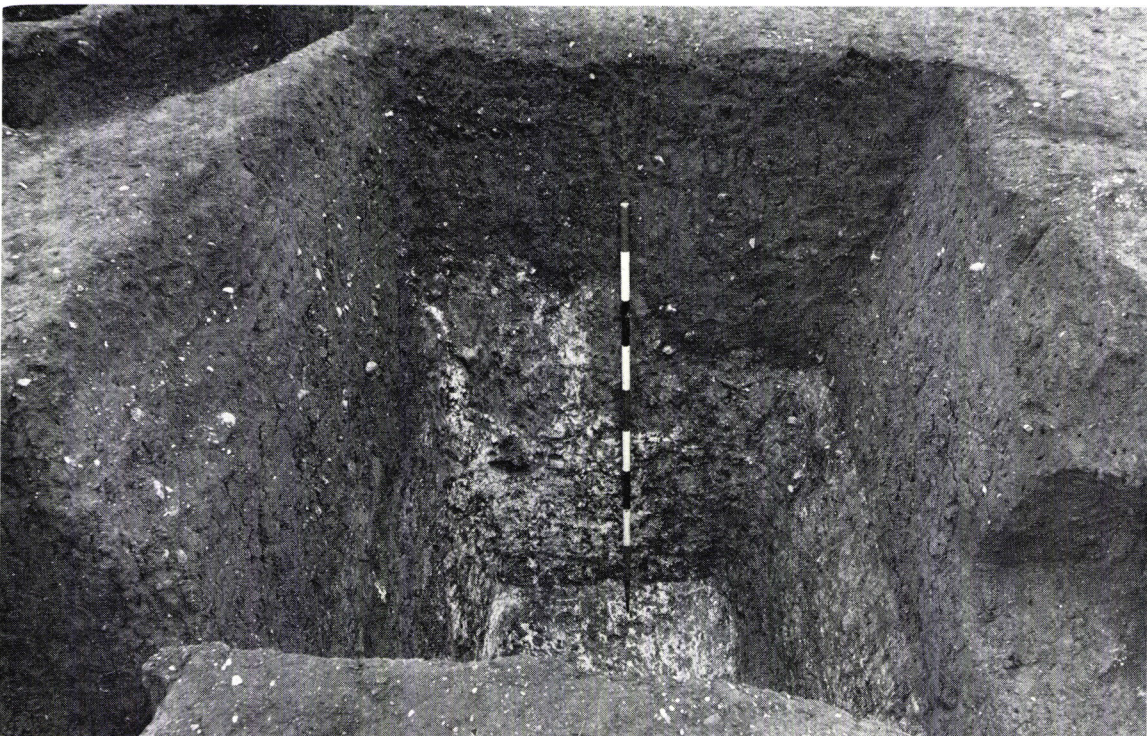

b. Pit 99, regularly cut with little erosion
(photo: David Baker)

PLATE XVI



General view of area C (1969) showing pits and post holes of all dates and sledge or wheel ruts of the early medieval period
(photo: David Baker)

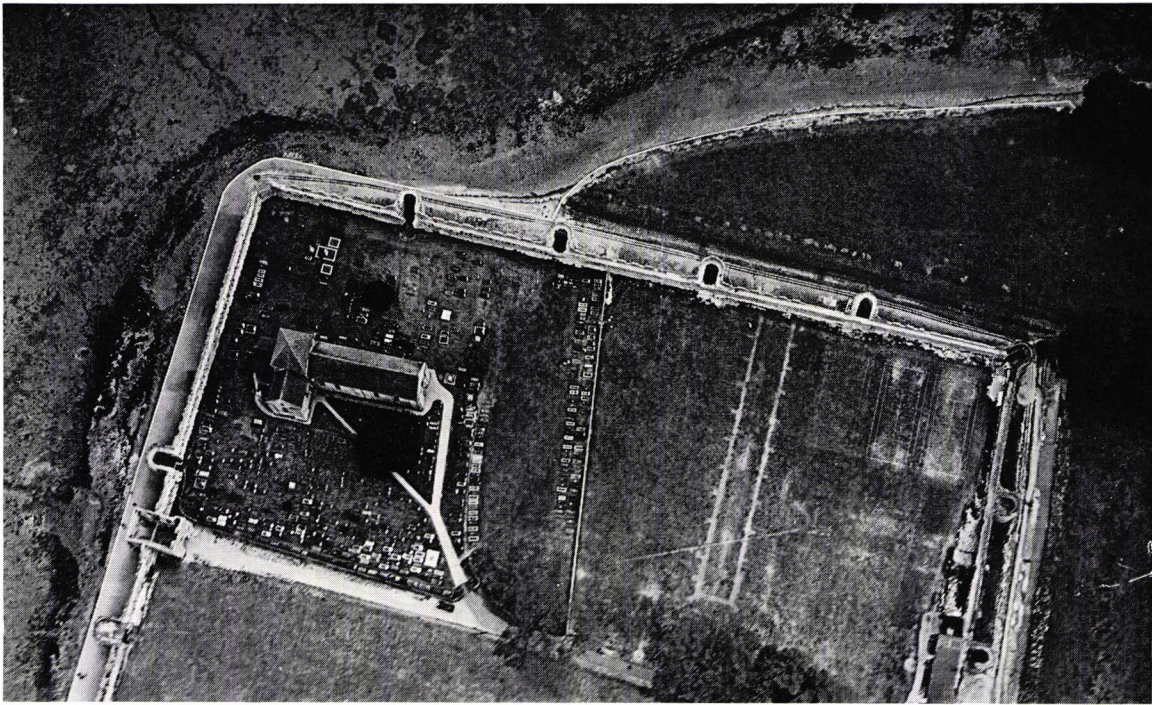

a. Air view taken by Major Allen shortly after the churchyard had been extended. The sixteenth-century storehouse shows as a cropmark. (The three rectangular marks in the top right corner are tennis courts
(photo: Ashmolean Museum)

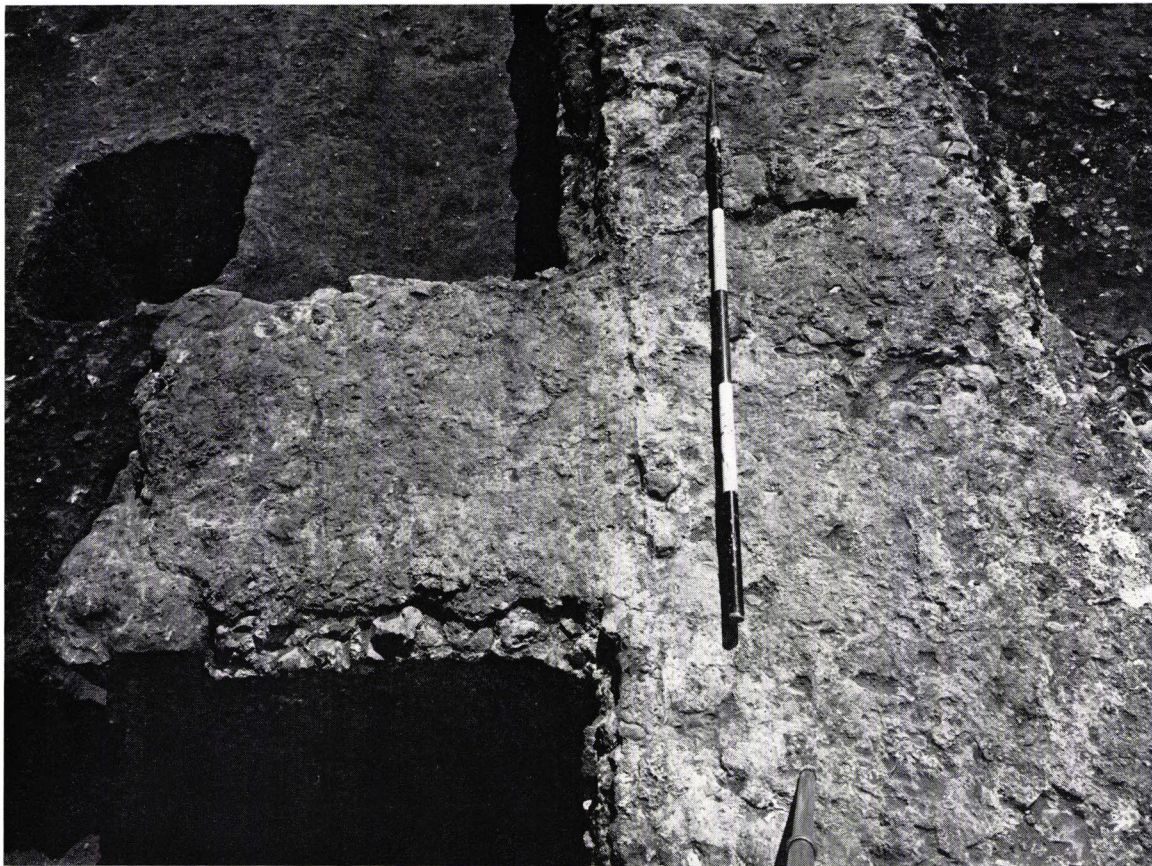

b. Storehouse foundation showing bedding mortar for the superstructure ignoring the foundation buttress
(photo: David Leigh)

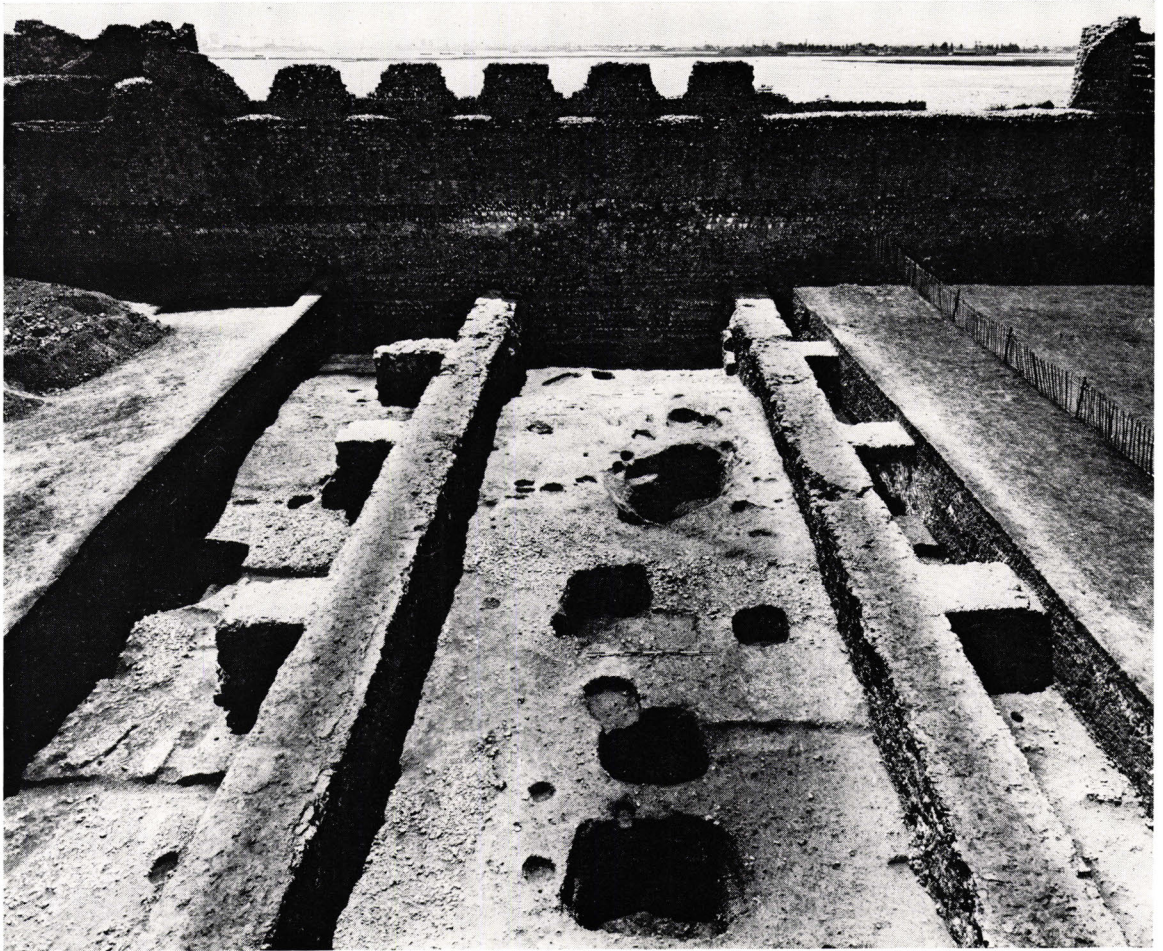

a. The Tudor store-house: south end looking south
(photo: David Leigh)



b. The Tudor storehouse: north end looking south
(photo: David Leigh)

PLATE XIX



a. Limekiln 2: general view
(photo: David Baker)

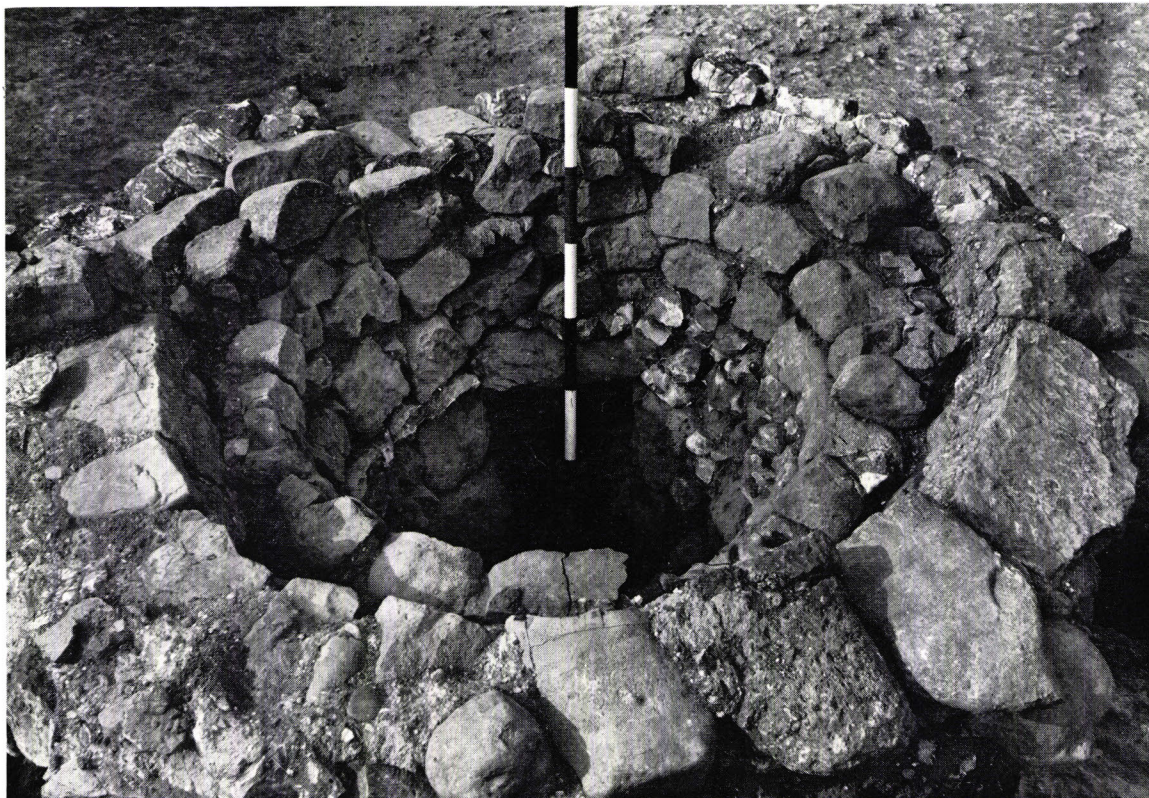

b. Limekiln 2: detail of chamber
(photo: David Baker)



a. Limekiln 2: flue a (see fig. 23)
(photo: David Baker)



b. Limekiln 2: flue b (see fig. 23)
(photo: David Baker)



a. Limekiln 1: general view from raking pit
(photo: David Baker)



b. Gullies 1, 2 and 4, facing north
(photo: David Baker)

PLATE XXII



General view of area excavated in 1967 showing gullies 1, and 2, leading to soakaway pit 78.
Looking east
(photo: David Baker)



a. Section of soakaway pit 78
(photo: David Baker)



b. North end of Tudor storehouse with gullies 31 and 32 below
(photo: David Baker)



a. Priory excavations: trench Pg
(photo: David Baker)



b. Priory excavations: trench P1
(photo: David Baker)

PLATE XXV



a. Priory excavations: trench P2
(photo: David Baker)



b. Priory excavations: trench P2, looking south
(photo: David Baker)

PLATE XXVI



a. Priory: garderobe abutting the north face of the south wall of the Roman fort
(photo: David Baker)

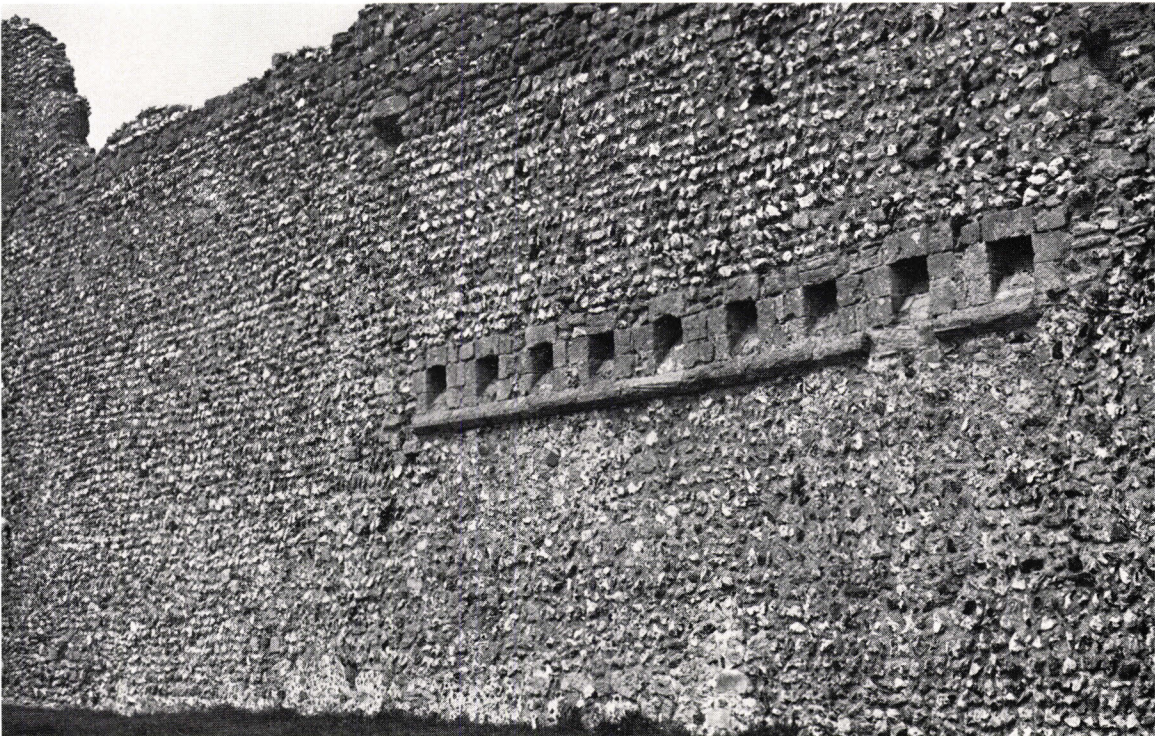

b. Priory: garderobe chutes opening through the south wall of the Roman fort
(photo: David Baker)



St. Mary's Church: west front, general view
(photo: David Baker)

PLATE XXVIII



a. St. Mary's Church: west window and arcade
(photo: Alan Borg)



b. St. Mary's Church: west door detail
(photo: Alan Borg)

PLATE XXIX



St. Mary's Church: view from the north-west
(photo: Mike Rouillard)



St. Mary's Church: the nave looking east
(photo: Mike Rouillard)

PLATE XXXI



a. St. Mary's Church: blocked doorway in the north wall of the nave
(photo: Mike Rouillard)



b. St. Mary's Church: capitals of south-west crossing pier, north face
(photo: Mike Rouillard)

PLATE XXXII



a. St. Mary's Church: capitals of north-east crossing pier, west face
(photo: Mike Rouillard)



b. St. Mary's Church: capitals of northeast crossing pier, south face
(photo: Mike Rouillard)

PLATE XXXIII

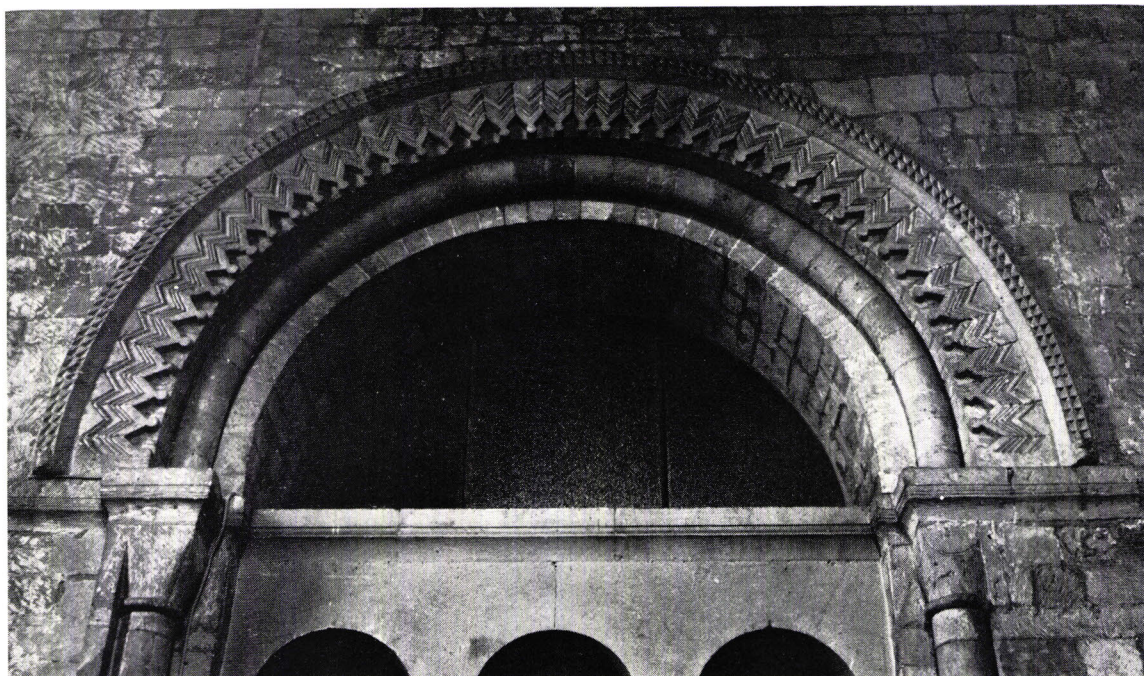

a. St. Mary's Church: arch of chapel in north transept
(photo: Mike Rouillard)



b. St. Mary's Church: window in north wall of north transept
(photo: Mike Rouillard)



St. Mary's Church: face of south wall showing the abutment of the demolished south transept
(photo: David Baker)



St. Mary's Church: face of south wall showing the abutment of the demolished west range
(photo: David Baker)



a. Yaverland: decoration of the south door of the church
(photo: Alan Borg)



b. Yaverland: decoration of the chancel arch
(photo: Alan Borg)



a. Petersfield: detail of the arcading above the crossing arches
(photo: Alan Borg)

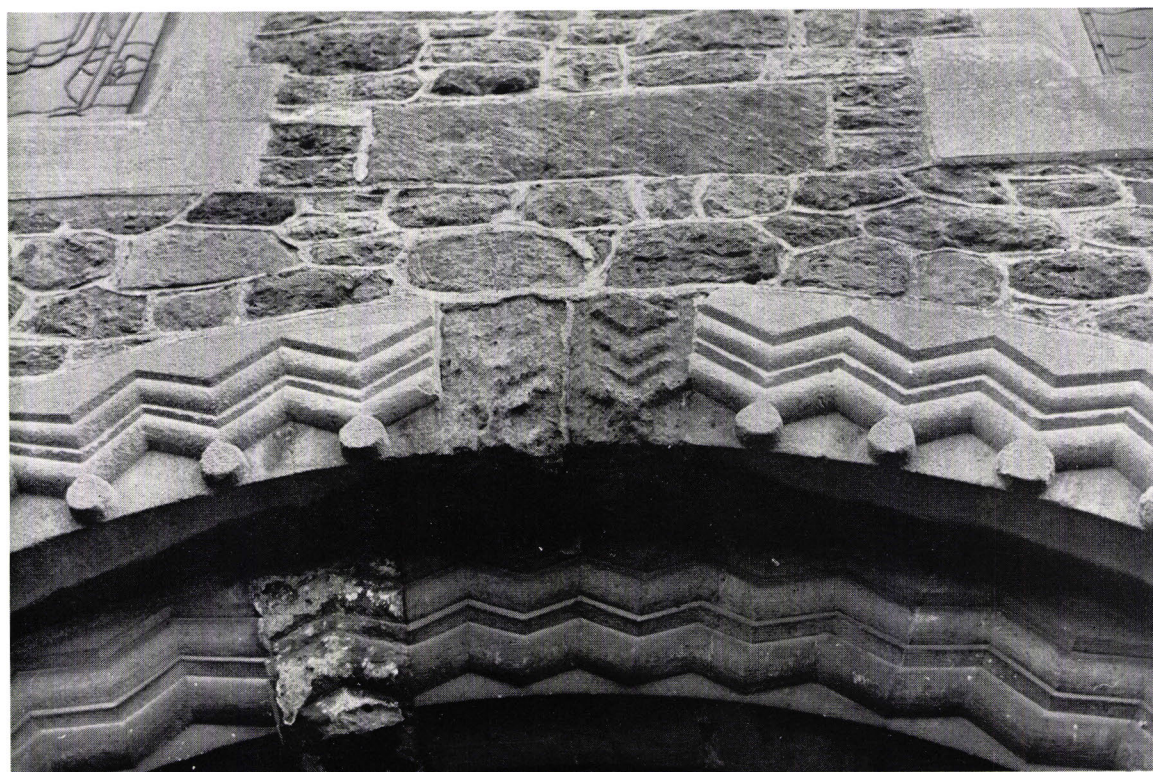

b. Petersfield: decoration of the western doorway arch
(photo: Alan Borg)

PLATE XXXVIII



b. East Wittering: doorway
(photo: Alan Borg)

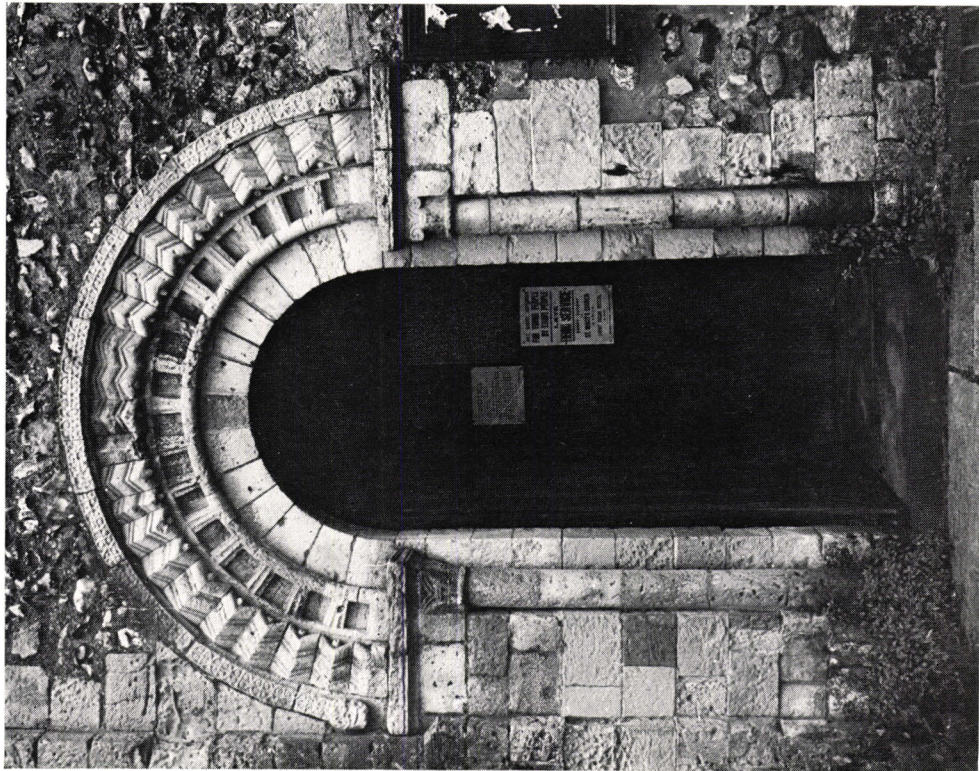

a. Old Shoreham: doorway
(photo: Alan Borg)

PLATE XXXIX



a. St. Mary's Church: the font
(photo: Mike Rouillard)



b. St. Mary's Church: detail of the font
(photo: Mike Rouillard)

PLATE XL

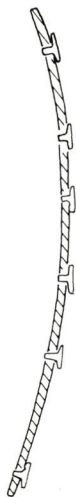
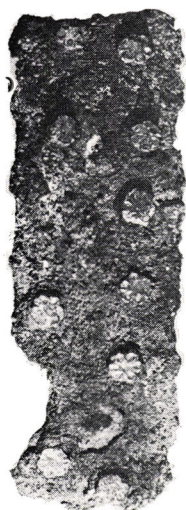

1

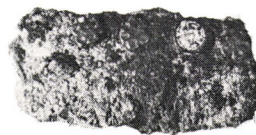

2a



2b

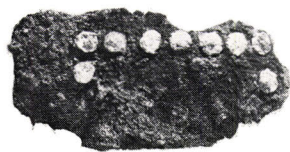

3

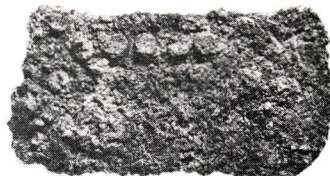

4

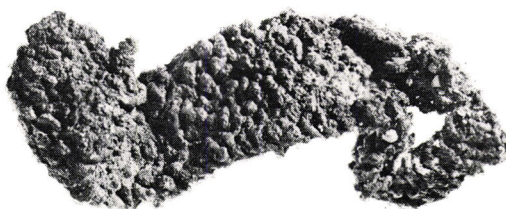

5

Armour fragments: see pp. 194-6
(photo: Bob Wilkins)

PLATE XLI

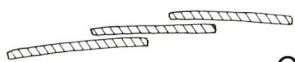
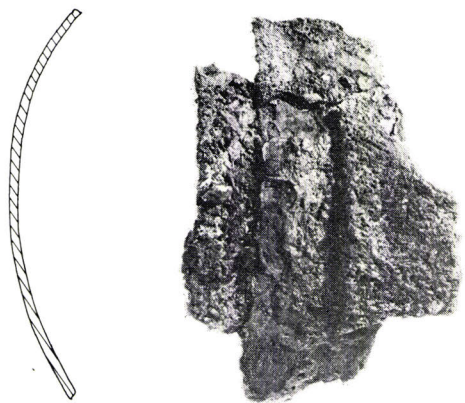

6



7

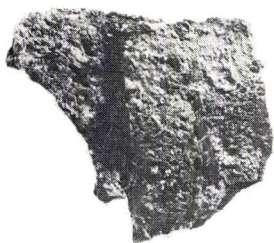

8

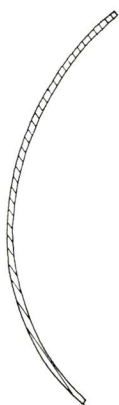
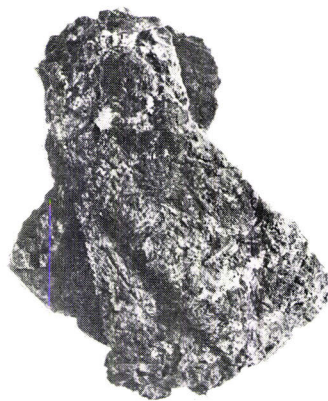

9

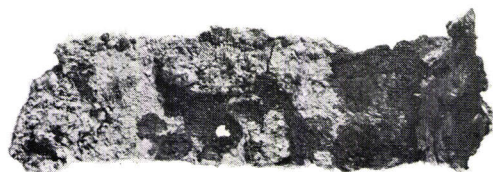

10

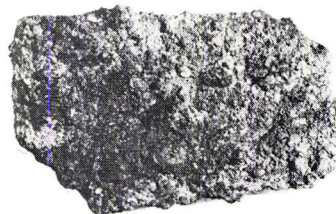

11

Armour fragments: see pp. 194-6
(photo: Bob Wilkins)



a. Brigandine, sixteenth-century
(photo: Tower Armouries)



b. Composite light field armour, sixteenth-century
(photo: Tower Armouries)

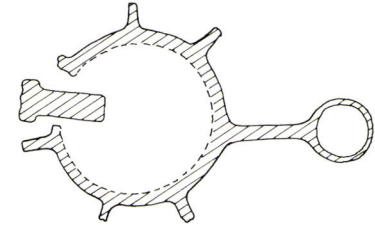

a. Inscribed wall plaster (1/3), p. 128

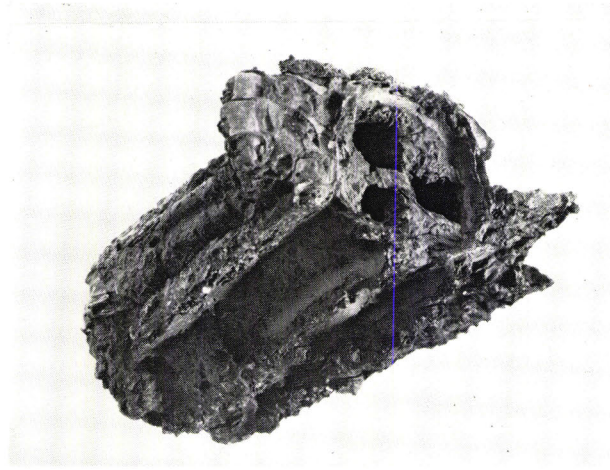

b. Iron padlock (1/1), p. 196



c. Lead ampulla (1/1), p. 207

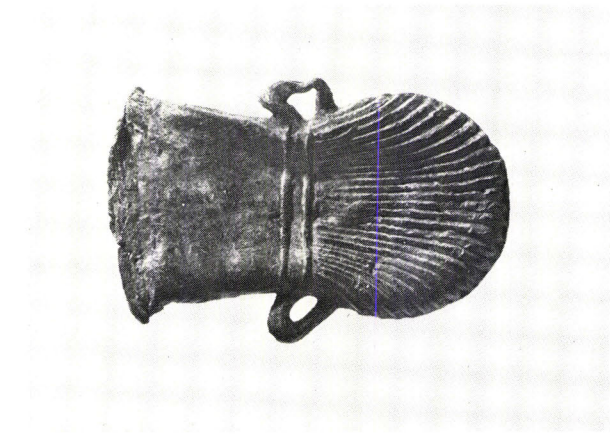

(photos: Bob Wilkins)

PLATE XLIV

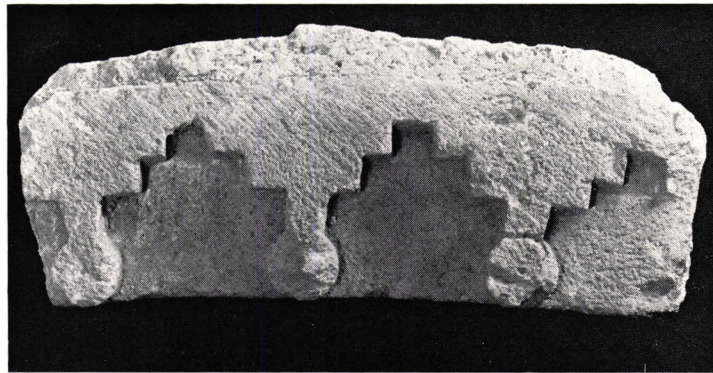

Moulded stones, all 1/1, pp. 127-8
(photo: Bob Wilkins)



Animal bones: (a) Sheep radius, gnawed at the distal end. (b) Cattle pelvis fragment, with a deep chop mark. (c) Sheep humerus with knife cuts across the shaft and proximal epiphysis. (d) Antler fragment with saw marks. (e) Cattle femur shaft, with saw marks at the distal end. (f) Cattle astragalus, extensively chopped. (g) Cattle tibia with fine knife marks on the proximal epiphysis. (h) Diseased dog tibia. (j) Diseased dog rib. (k) Abnormal sheep mandible. (l) Sheep horn core. (m) Diseased roe deer mandible

(photo: Bob Wilkins)

